



深圳市凯越翔电子有限公司

石英谐振器规格书

| | |
|---------|------------------|
| 产品名称: | 石英晶振谐振器 |
| 产品型号: | FC-135/32.768KHZ |
| 产品参数: | 7PF/±20ppm |
| 原厂型号: | KFC327680720 |
| 凯越翔技术部: | 董宗全 |

客户确认印栏

| | |
|-------|-------|
| 认证印章 | 负责人印章 |
| 年 月 日 | 年 月 日 |

| | | | | | |
|----|-----|----|-----|----|-----|
| 拟制 | 成望生 | 审核 | 董宗全 | 批准 | 谢为亮 |
|----|-----|----|-----|----|-----|

本规格章程连同本页共 9 页

工厂地址: 深圳市龙华区观澜人民路蔡发工业城 1 栋 4 层, TEL: 0755-89315823 89315866
FAX:0755-89315223 官网: www.kaiyuexiang.com

INTRODUCTION

1. The contents is subject to change without notice.
Please exchange the specification sheets regarding the product's warranty.
2. This sheet is not intended to guarantee or provide an approval of implementation of industrial patents.
3. We have prepared this sheet as carefully as possible.
If you find it incomplete or unsatisfactory in any respect, We would welcome your comments.

深圳市凯越翔电子有限公司

This Product supplied (and any technical information furnished, if any) by Epson Toyocom Corporation shall not be used for the development and manufacture of weapon of mass destruction or for other military purposes. Making available such products and technology to any third party who may use such products or technologies for the said purposes are also prohibited.

This product listed here is designed as components or parts for electronics equipment in general consumer use. We do not expect that any of these products would be incorporated or otherwise used as a component or part for the equipment, which requires an extra high reliability, such as satellite, rocket and other space systems, and medical equipment, the functional purpose of which is to keep life.

Contents

| Item No. | Item | Page |
|----------|--|--------|
| [1] | Absolute maximum ratings | 2 |
| [2] | Operating range | 2 |
| [3] | Static characteristics | 2 |
| [4] | Environmental and Mechanical characteristics | 3 to 4 |
| [5] | Dimensions and Marking layout | 5 to 6 |
| [6] | Notes | 7 |

[1] Absolute maximum ratings

| Item | Symbol | Rating value |
|---------------------|--------|-----------------|
| Storage temperature | TSTG | -55°C to +125°C |
| Maximum drive level | DL | 1.0 μW |

[2] Operating range

| Item | Symbol | Value | | |
|-----------------------------|--------|-------------|--------|--------|
| | | Min. | Typ. | Max. |
| Operating temperature range | TOPR | -40°C | | +85°C |
| Drive level | DL | 0.01 μW | 0.1 μW | 0.5 μW |
| Vibration mode | | Fundamental | | |

[3] Static characteristics

| Item | Symbol | Value | Note |
|-------------------------|----------------|---|--|
| Frequency | f _i | 32.768 kHz | |
| Frequency tolerance | Δ f/f | ± 20 × 10 ⁻⁶ | CL = 9 pF , 12.5 pF Ta = +25 ± 3°C, Drive level : 0.1 μW Not include aging |
| Series resistance | R ₁ | 70 kΩ Max. | CI meter : Saunders 140B Drive level : 0.5 μW |
| Motional capacitance | C ₁ | Typ. 3.4 fF | |
| Shunt capacitance | C ₀ | Typ. 1.2 pF | |
| Turnover temperature | θ _T | +25 ± 5 °C | Values are calculated by the frequencies at +10, +25, +40°C with C-MOS circuit. |
| Temperature coefficient | a | -4.0 × 10 ⁻⁸ /°C ² Max. | |
| Isolation resistance | IR | 500 MΩ Min. | DC 100V, 60 seconds Between terminal #1 and terminal #2 |
| Aging | fa | ± 3 × 10 ⁻⁶ / year | Ta = +25 °C ± 3 °C Drive level : 0.1 μW |

[4] Environmental and Mechanical characteristics

| No. | Items | Value | Conditions |
|-----|-------------------------------|---|---|
| 1 | Shock resistance | *3Δ f/f : ± 8 × 10 ⁻⁶ | 100g dummy(SEIKO EPSON Standard), Natural drop from 1500 mm height on to the concrete. 3 directions × 10 times *2 |
| 2 | Vibration resistance | *3Δ f/f : ± 3 × 10 ⁻⁶ | 10 Hz to 55 Hz amplitude 0.75 mm 55 Hz to 500 Hz acceleration 98 m/s ² 10 Hz → 500 Hz → 10 Hz 15 min./cycle 6 h (2 hours , 3 directions) *2 |
| 3 | Soldering heat resistance | Δ f/f : ± 5 × 10 ⁻⁶ | For convention reflow soldering furnace (2 times) |
| 4 | High temperature storage | *3Δ f/f : ± 10 × 10 ⁻⁶ | +125 °C × 1000 h *1 |
| | | *3Δ f/f : ± 7 × 10 ⁻⁶ | +85°C × 1000 h *1 |
| 5 | Low temperature storage | *3Δ f/f : ± 10 × 10 ⁻⁶ | -55 °C × 1000 h *1 |
| 6 | High temperature and humidity | *3Δ f/f : ± 10 × 10 ⁻⁶ | +85°C × 85%RH × 1000 h *1 |
| 7 | Temperature cycle | *3Δ f/f : ± 10 × 10 ⁻⁶ | -55 °C ↔ +125°C 30 minutes at each temperature × 100 cycles *1 |
| 8 | Sealing | *3 1 × 10 ⁻⁸ hPa·l / s Max. | For He leak detector |
| 9 | Shear | No peeling-off at a soldered part | 20 N press for 10 ± 1 s. Ref. IEC 60068-2-21 |
| 10 | Pull - off | No peeling-off at a soldered part | 20 N press for 10 ± 1 s. Ref. IEC 60068-2-21 |
| 11 | Substrate bending | No peeling-off at a soldered part | Bend width reaches 3 mm and hold for 5 s ± 1 s × 1 time Ref. IEC 60068-2-21 |
| 12 | Solvent resistance | The marking shall be legible | Ref. JIS C 0052 or IEC 60068-2-45 |

< Notes >

1. *1 Each test done independently.
2. *2 Measuring 2 h to 24 h later leaving in room temperature after each test. Drive level : 0.5 μW
3. *3 Pre conditionings(Treat the Reflow 2 times with the following profile) Initial value shall be after 24 h at room temperature.
Shift of series resistance at before and after the test should be less than ±20 % or less than ±15kΩ.
In case high temperature storage(+125°C × 1 000 h), Soldering heat resistance, shift of series resistance at before and after the test should be less than ±30 % or ±20 kΩ.

◆ Air reflow

Pre heating temperature: +170 [°C]
Heating temperature : +220 [°C]

Pre heating time: 100 [s]
Heating time : 30 [s]

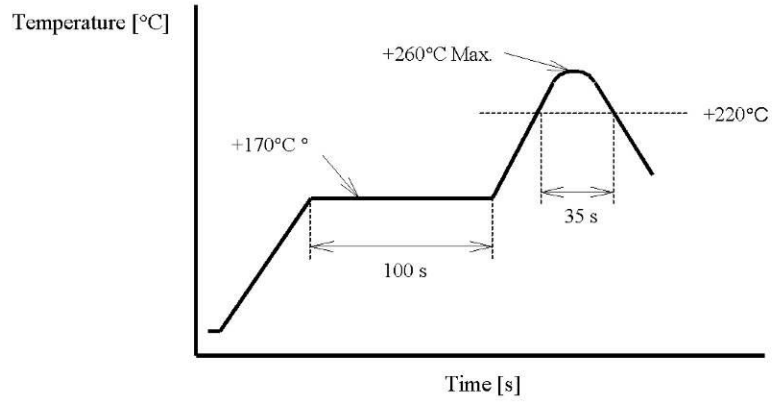

[5] Dimensions and Marking layout

1. Dimensions

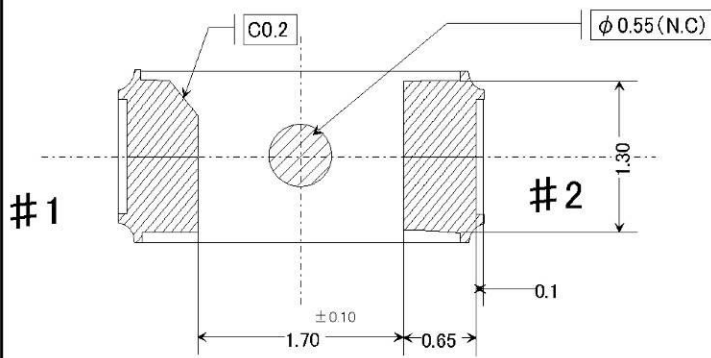
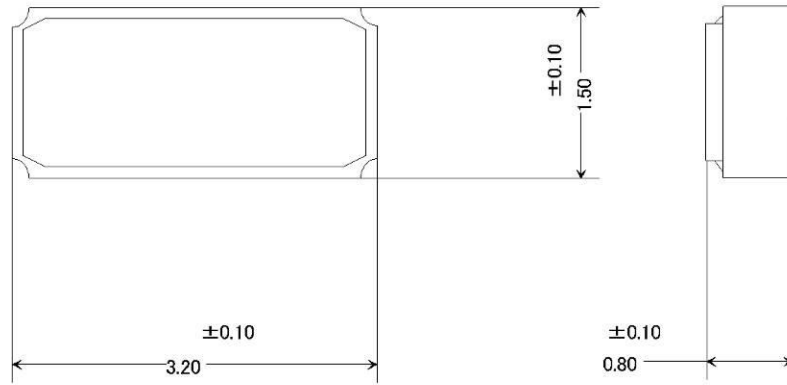

Package : Ceramic(Al_2O_3)
 Terminal Au plate : $0.5 \mu m$ Min.
 Lid : Glass

2. Internal Connection

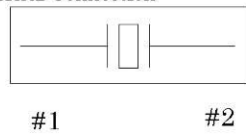

| | | | | | |
|------|--------|--------------------|------------|------|----------|
| Type | FC-135 | Terminal treatment | Au plating | Unit | 1 = 1 mm |
|------|--------|--------------------|------------|------|----------|

3. Recommended soldering pattern

Unit : 1 = 1 mm

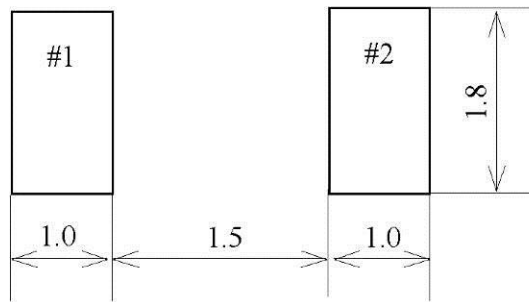

4. Marking layout

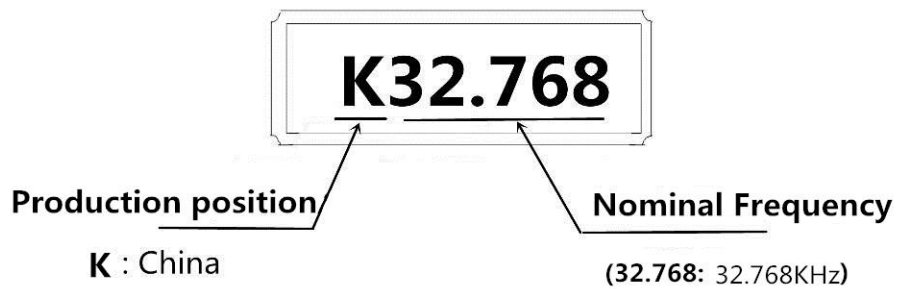

* The above marking layout shows only marking contents and their approximate position and it is not for font, size and exact position.

| | | | |
|------|--------|------|--------|
| Type | FC-135 | Unit | 1=1 mm |
|------|--------|------|--------|

[6] Notes

1. Max two (2) times reflow is allowed. Once miss soldering is happened, hand work soldering by soldering iron is recommended. (+350°C × within 5 s)
2. Patterning should be followed by our recommended one.
3. Applying excessive excitation force to the crystal resonator may cause deterioration damage.
4. Unless adequate negative resistance is allocated in the oscillation circuit, start up time of oscillation may be increased, or no oscillation may occur.

How to check the negative resistance.

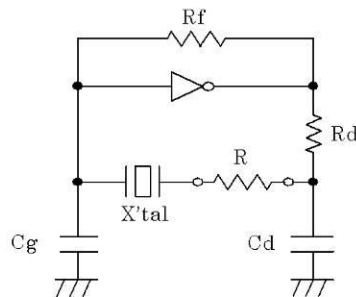

- (1) Connect the resistance (R) to the circuit in series with the crystal resonator.
- (2) Adjust R so that oscillation can start (or stop).
- (3) Measure R when oscillation just start (or stop) in above (2).
- (4) Get the negative resistance
 $-R = R + CI$ value.
- (5) Recommended $-R$
 $|-R| > CI \times (5 \sim 10)$

5. The shortest patterning line on board is recommendable.
Too long line on board may cause of abnormal oscillation.
6. To avoid mull function, no pattern under or near the crystal is allowed.
Solder paste should be more than 150 μm thickness.
7. This device must be stored at the normal temperature and humidity conditions before mounting on a board.
8. Too much exciting shock or vibration may cause deterioration on damage.
Depending on the condition such as a shock in assembly machinery, the products may be damaged.
Please check your condition in advance to maintain shock level to be smallest.
9. Depending on the conditions, ultrasonic cleaning may cause resonant damage of the internal crystal resonator. Since we are unable to determine the conditions (type of cleaning unit, power, time, conditions inside the bath, etc.) to be used in your company, we cannot guarantee the safety of this unit when it is cleaned in an ultrasonic cleaner.
10. Ink marking may be damaged by some kind of solvent, please take precautions when choosing solvent by your selves.
11. Please refer to packing specification regarding how to storage the products in the pack.

X-ON Electronics

Largest Supplier of Electrical and Electronic Components

Click to view similar products for [Crystals](#) category:

Click to view products by [KYX](#) manufacturer:

Other Similar products are found below :

[CX3225GB25000M0PPSZ1](#) [718-13.2-1](#) [7A-40.000MAAE-T](#) [FL2000085](#) [99-BU](#) [9B-15.360MBBK-B](#) [9C-7.680MBBK-T](#) [H10S-12.000-18-EXT-TR](#) [ABC2-6.000MHZ-D4Z-T](#) [ABLS-20.000MHZ-D2-T](#) [ABS071-32.768KHZ-6-T](#) [R38-32.768-12.5-5PPM-NPB](#) [BTD1062E05A-513](#) [21U15A-21.4MHZ](#) [RTX-781DF1-S-20.950](#) [LFXTAL066198Cutt](#) [9C-14.31818MBBK-T](#) [A-11.000MHZ-27](#) [ABL-27.000MHZ-B4Y-T](#) [ABM11-132-24.000MHZ-T3](#) [ABM3B1-25.000MHZ-D2Y-T](#) [SPT2A-.032768B](#) [SPT2A.032768G](#) [LFXTAL065253Cutt](#) [LFXTAL066431Cutt](#) [XT9S20ANA14M7456](#) [XT9SNLANA16M](#) [7A-24.576MBBK-T](#) [7B-30.000MBBK-T](#) [CX2520DB16000H0HPQCC](#) [MMCC2R32.7680KHZ](#) [6504-202-1501](#) [6526-202-1501](#) [ABLS-12.000MHZ-B2Y-T](#) [7A-10.000MBBK-T](#) [SG636PCE-20.000MC](#) [3404](#) [CM315D32768EZFT](#) [C1E-24.000-7-2020-R](#) [C1E-19.200-12-1530-X-R](#) [C1E-16.000-12-1530-X-R](#) [ABM11-16.000MHZ-9-B1U-T](#) [FL5000014](#) [EUCA18-3.1872M](#) [FX0800015](#) [425F35E027M0000](#) [FP0800018](#) [MS3V-T1R-32.768kHz-7pF-20PPM-TA-QC-Au](#) [VXM7-1C1-16M000](#) [MS3V-T1R-32.768kHz-9pF-20PPM-TA-QC-Au](#)