



## 陶振规格书

产品名称:	陶振
产品型号:	ZTT/8.000 MHZ
产品参数:	0.1%~0.3%
原厂型号:	KZT8000
凯越翔技术部:	董宗全

### 客户确认印栏

认证印章	负责人印章
年 月 日	年 月 日

拟制	成望生	审核	董宗全	核准	谢为亮
----	-----	----	-----	----	-----

本规格章程连同本页合共 6 页

### 1. SCOPE

(范围)

This specification is applied to the ceramics resonator used for microcomputer  
(本规格书适用于微电子用陶瓷谐振器)

### 2. MODEL NAME

(产品名称)

Part No. (产品号)	Customer's Part No.(顾客产品号)	Drawing No.(图号)
ZTT MX	/	XT-067

### 3. DIMENSIONS

(尺寸)

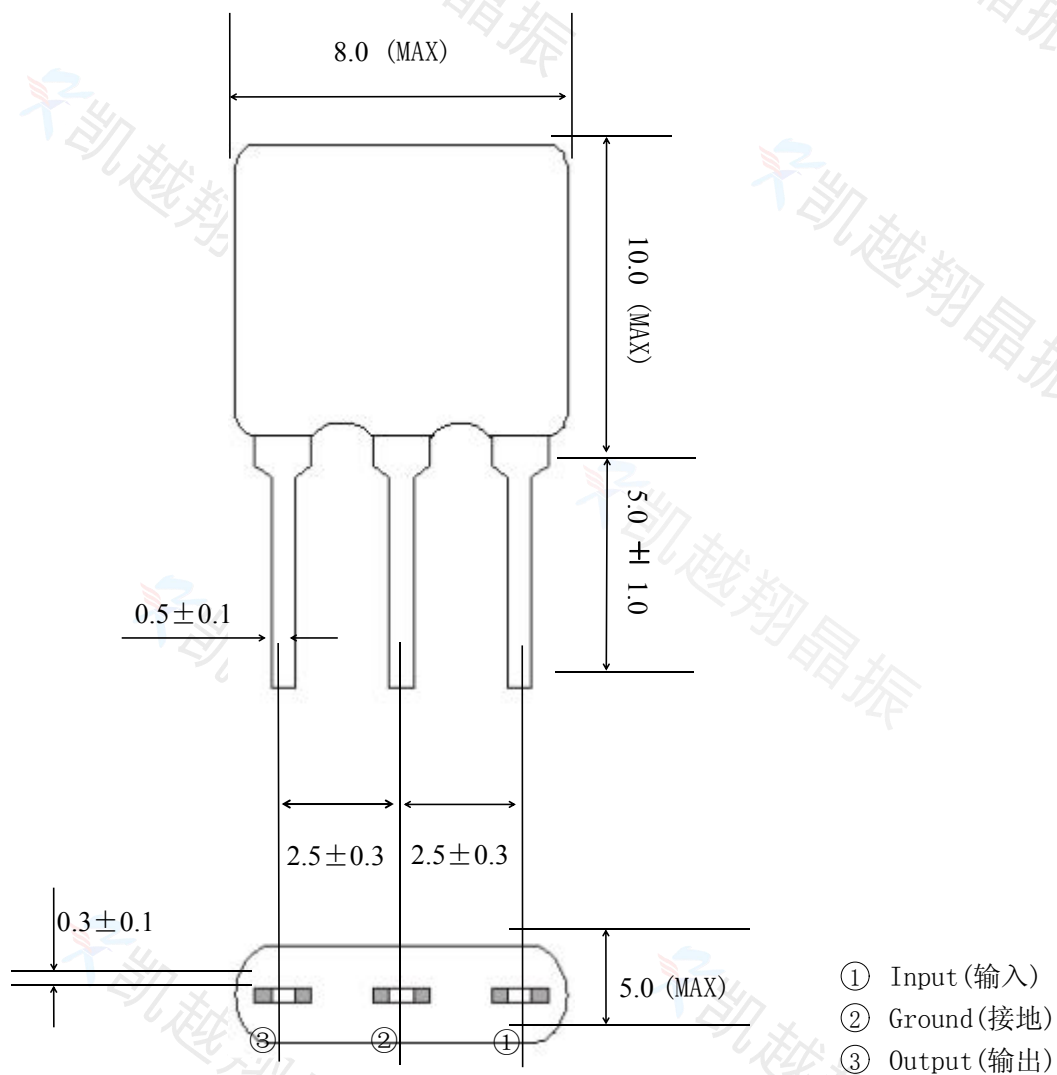

#### Materials(材料)

Terminal(引脚)	Sn plated on Fe (铁镀锡)
Coating(涂料)	Epoxy Resin (环氧树脂)

Unit(单位): mm

#### 4. ELECTRICAL CHARACTERISTICS

(电气性能)

	Item (项目)	Requirements (要求)
1	Oscillation Frequency(Fosc) (振荡频率)	8.000 MHZ
2	Frequency Tolerance (频率公差)	Fosc ± 0.1 % ~ ± 0.3% (max)
3	Resonator Impedance (谐振阻抗)	30 Ω (max)
4	Build in Capacitor (内置电容)	30 pF ± 20% (max)
5	Operating Temp. Range (工作温度范围)	-20°C ~ +70°C
6	Temperature Stability (温度稳定性)	± 0.5% (MAX) (-35°C ~ +85°C)
7	Max Voltage (最大电压)	6V DC; 15V P-P
8	Withstanding Voltage (耐电压)	D.C. 100V, 5Sec
9	Insulation Resistance (绝缘阻抗)	100MΩ min (D.C. 100V)
10	Aging(10 years) (10 年老化率)	± 0.3 %
11	Storage Temp. Range (贮存温度范围)	-40°C ~ +85°C
12	Test Temp.&Humi.Condition (测试温、湿度条件)	+10°C ~ +30°C、40%~80%

#### 5. TEST CIRCUIT

(测试电路)

Unless any necessity to measure under a standard condition(Temp:20 ± 2°C .Humi.:65 ± 5%)is occurred.( 必要时标准测量条件为温度 20 ± 2°C, 相对湿度 65 ± 5%)

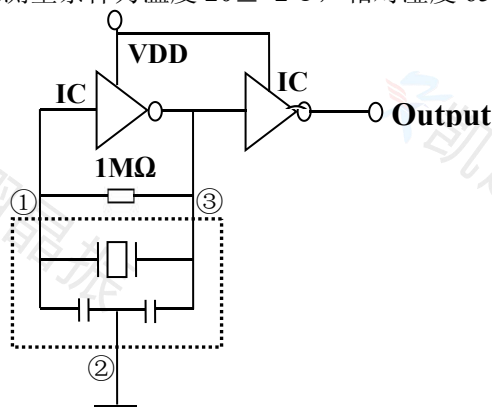

- ① Input (输入)
- ② Ground (接地)
- ③ Output (输出)

IC: 1/6CD4069UBE × 2

VDD= +5V(DC)

## 6. PHYSICAL AND ENVIRONMENTAL CHARACTERISTICS

(物理及环境特性)

	Test Item (试验项目)	Condition of Test (试验条件)	Requirements (要求)
1	Lead Strength (引脚强度) Lead Pulling (引脚拉力) Lead Bending (引脚弯曲)	Force of 0.5kg is applied to each lead in axial direction for 10sec..(沿每个引脚轴向施加 0.5kg 力保持 10 秒钟) When force of 0.25kg is applied to each lead in axial direction.the lead shall folded up to 90° from the axial direction and folded back to the axial direction.(沿引脚轴向施加 0.25kg 力的时候把引脚折弯 90 度后再折回原形)	No mechanical damage and the measured values shall meet Table 1.(无机械损伤, 测量值满足表 1 要求)
2	Solderability (可焊性)	Lead terminals are immersed in resin for 5 seconds and then immersing in a soldering bath(235±5℃)for 5±0.5sec.(引脚在助剂内浸 5 秒后再浸入 235±5℃ 的锡炉内 5±0.5 秒)	The solder shall coat at least 90% of the surface of terminal(引脚上锡覆盖率≥90%)
3	Storage in High Temp. (高温贮存)	After being placed in a chamber with 85℃ for 100 hours and then being placed in natural condition for 1 hours, then measure.(85℃环境下存放 100 小时后取出自然存放 1 小时测试)	The measured value shall meet Table 1(测量值满足表 1 要求)
4	Storage in Low Temp. (低温贮存)	After being placed in a chamber with -25℃ for 100 hours and then being placed in natural condition for 1 hours, then measure.(-25℃环境下存放 100 小时后取出自然存放 1 小时测试)	
5	Humidity (潮湿)	After being placed in a chamber (Humi.:90~95%RH,Temp.:40±2℃) for 100 hours and then being placed in natural condition for 1 hours, then measure. (温度 40±2℃ ; 湿度 90~95% 的环境下存放 100 小时后取出自然存放 1 小时测试)	
6	Thermal Shock (热冲击)	After temperature cycling of -55℃(30 minutes)to +85℃(30 minutes)was performed 5 times,Resonator shall be measured after being placed in natural condition for 1 hour(-55℃下 30 分钟到+85℃下 30 分钟循环 5 次后自然存放 1 小时测量)	
7	Resistance to soldering Heat (耐焊接热)	Lead terminals are immersed up to 2.0 mm from the root of terminals in solder bath of 265±5℃ for 10±1seconds, Resonator shall be measured after being placed in natural condition for 1 hour.( 引脚距根部 2mm 以下浸入 265±5℃ 的锡炉中 10±1 秒取出自然存放 1 小时测量)	

续上表:

8	Random Drop (自由跌落)	Resonator shall be measured after 3 times random dropping from the height of 1 m to concrete floor.(谐振器从 1 米高向水泥地板自由跌落 3 次后测量)	
9	Vibration (振动)	Resonator shall be measured after being applied vibration as below:(谐振器做如下振动后测量) Vibration Freq.(振动频率): 10 Hz to 55 Hz Amplitude(幅度): 1.5mm Directions(方向): 3 axial directions (三轴向) Time(时间): 1 hour/each direction (1 小时/向)	
10	Composite temperature / Humidity cycle test (温湿度测试)	<p>The piezoelectric oscillator shall be subjected to 10 continuous cycles,each as shown in figure below.Then the piezoelectric oscillator shall be stored at standard atmospheric conditions for 24 h for recovery,after which measurement shall be made.</p> <ul style="list-style-type: none"> <li>● Temperature shall be reduced from 25℃ to -10℃ within 30 min.</li> <li>● Humidity uncontrolled at a temperature less than 25℃</li> </ul> <p>用下图表示连续 10 次温湿度测试情况,然后在常温下放置 24 小时测试。在 30 分钟内将温度从 25℃ 调节至 -10℃,在温度低于 25℃ 时湿度无控制。</p> 	The measured value shall meet Table 1(测量值满足表 1 要求)

Table 1(表 1)

Item (项目)	Limit Value (限定值)
Oscillation Frequency(Fosc) (振荡频率)	$\leq \pm 0.3\%$
Resonator Impedance (谐振阻抗)	$\leq \pm 10 \Omega$

※ Note: The limits in the above table are referenced to the initial measurements.  
(上表中的限定值参照初始测量值)

## 7. NOTICE

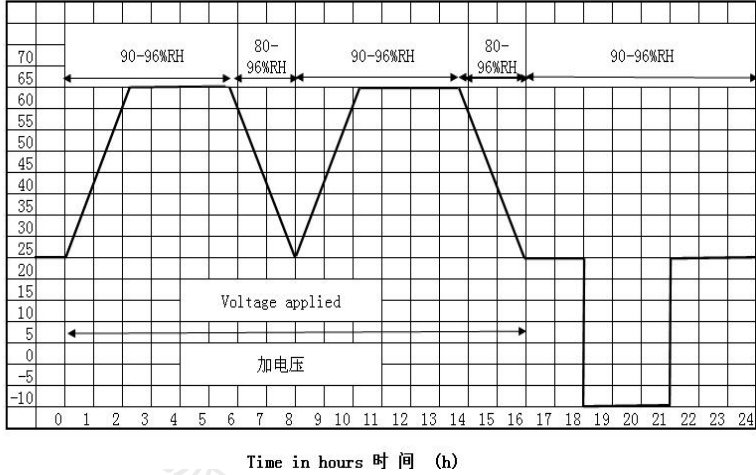
(注意)

1. Do not use this product with bend. The component may be damaged if excess Mechanical stress is applied to it mounted on the printed circuit board. (本产品不能折弯使用，在电路板安装时使用过大的机械压力可能造成产品损坏。)
2. This specification limits the quality of the component as a single Unit Please make sure that the component is evaluated and confirmed the drawing When it is mounted to your product. (本规格书只规定了部件本身的品质，应用于您的产品时请确认图纸该产品是否适用。)

## 8. Cutaway view

(剖面图)

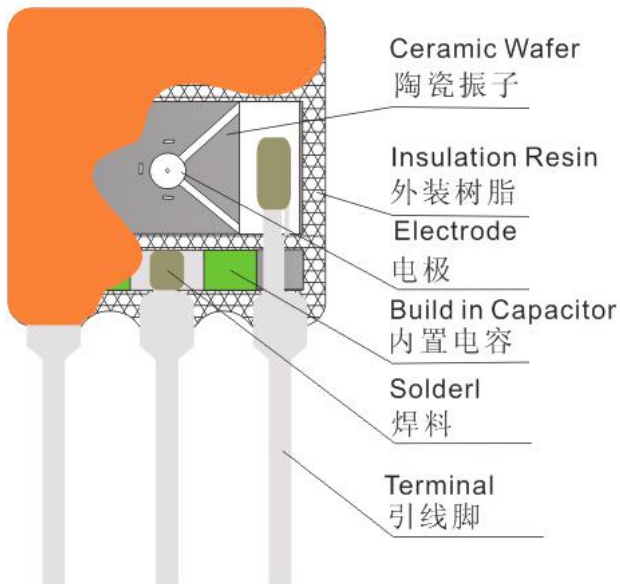

## X-ON Electronics

Largest Supplier of Electrical and Electronic Components

*Click to view similar products for [Resonators](#) category:*

*Click to view products by [KYX](#) manufacturer:*

Other Similar products are found below :

[B39431R820H210](#) [ECS-HFR-40.00-B-TR](#) [CSTLS4M00G53Z-A0](#) [ECS-HFR-20.00-B-TR](#) [CSTNE16M0V510000R0](#)  
[CSTNE14M7V510000R0](#) [CSTNE8M00GH5C060R0](#) [DJ2032K768C5T8188X01](#) [KZA20000](#) [KZA3580](#) [KZA107](#) [HCTB1-1.000-CRBHRL](#)  
[SF11S5-1582.400-F04IL02AL](#) [AWSZT-3.58CP-T4](#) [SF33M6-836.500-F25IL28AL](#) [HCTB1-460.000-CRBEL](#) [SF33M6-1960.000-F60IL25AL](#)  
[SRD11-315.000-F75IL22AL](#) [SR21S4-433.920-F75IL18AL](#) [SF11S5-915.000-F26IL02AL](#) [SF33M6-1575.420-F02IL40AL](#) [SR32M4-433.920-](#)  
[F75IL25AL](#) [SRTO39-316.800-F75IL13AL](#) [HCTB1-455.000-CRBEL](#) [KZA24000](#) [KZT6000](#) [KZA8000](#) [KZA169344](#) [KZT2350](#) [KZT169344](#)  
[KZT24000](#) [KF143392](#) [KZA4000](#) [KTOR423](#) [KUM20950](#) [KZB455E](#) [KZA16000](#) [KZT16000](#) [KZT4190](#) [KZA12000](#) [KZA3640](#) [KZT10000](#)  
[KD143392](#) [KZT20000](#) [KTO43392](#) [KZA2000](#) [KZA5000](#) [KZT3640](#) [KZT12000](#) [KZB460E](#)