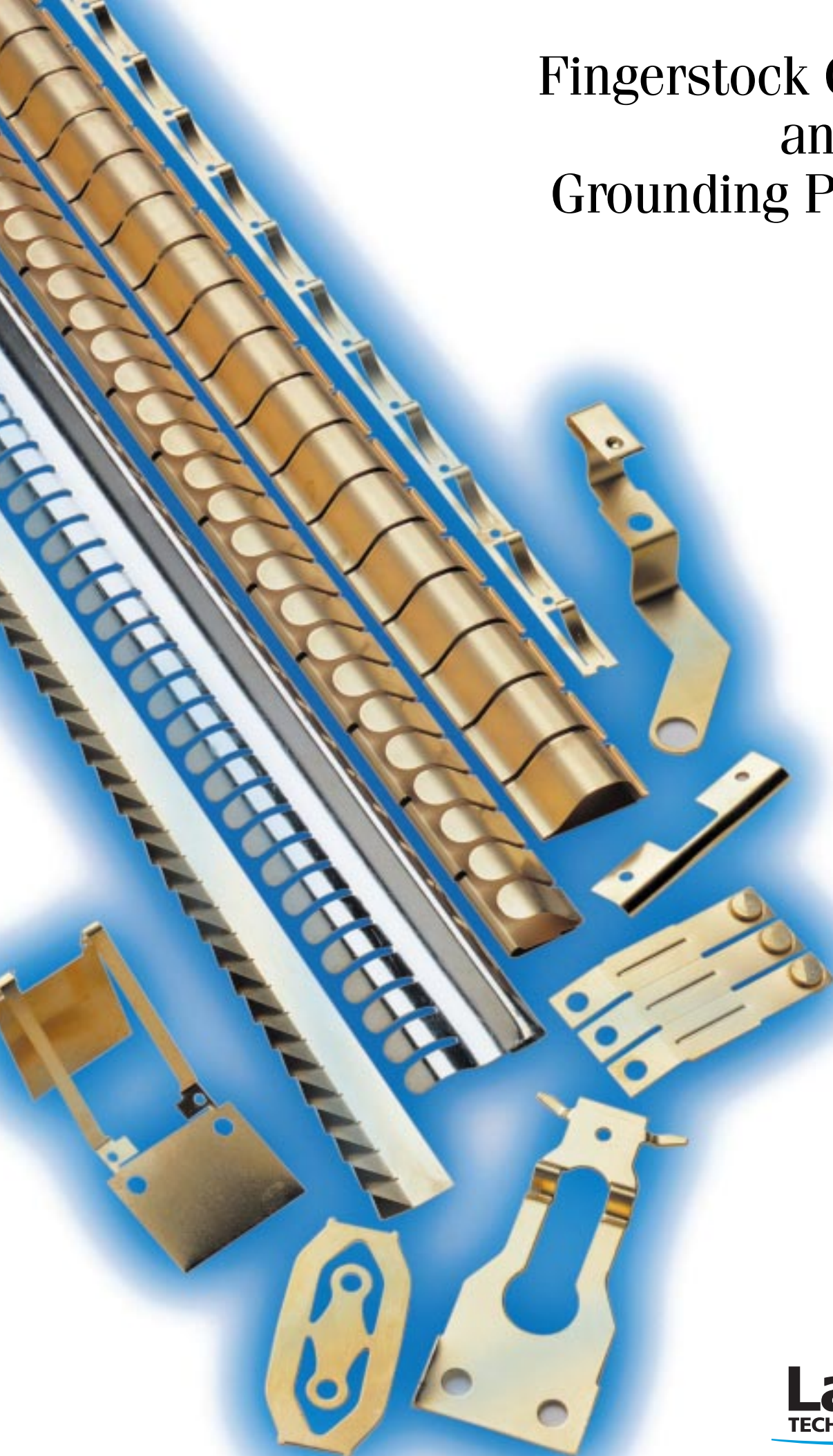


Fingerstock Gaskets and Metal Grounding Products





Features & Benefits of Fingerstock

- Typical average shielding effectiveness of 80 – 100 dB
- Wide operating range of parts (20% – 80% of standing height is typical)
- No variability in shielding effectiveness based on amount of deflection
- Wide variety of design, sizes and attachment options
- Zero compression set ensures long EMI reliability
- Best option for wiping or shear applications due to durability and spring design
- All products can be cut to length and/or modified with removal of fingers and additional bends, slots or holes
- Exceptional dimensional stability
- Most parts are available from stock in beryllium copper material. Other materials including stainless steel, phosphorus bronze, etc. can also be utilized.
- Physical properties of beryllium copper include ability to withstand temperatures up to 250° F (121° C) without deformation or out-gassing, and resistance to moisture and ultraviolet radiation
- Over 20 in-house plating options are available to ensure galvanic compatibility and solderability
- Most parts are available in UltraSoft[®] version (78-XXX and 98-XXX) for lowest possible compression forces

Contips[®], ElectroNit[®], Grip-tite[®], Magnefil[®], Snap-lite[®], Sticky Fingers[®] and UltraSoft[®] are registered trademarks of Laird Technologies. Poron[®] is a registered trademark of Rogers Corp. AMP[®] is a registered trademark of The Whitaker Corporation. Methode[®] is a registered trademark of Methode Electronics, Inc. Tyco[™] is a trademark of Tyco International Services AG. Cisco Systems[®] is a registered trademark of Cisco Systems, Inc. Dell[®] is a registered trademark of Dell Computer Corporation. IBM[®] is a registered trademark of IBM Corporation.

Notice:

Information on the products described in this catalog is based on laboratory test data which Laird Technologies believes to be reliable. However, Laird Technologies has no control over the design of actual products which incorporate Laird Technologies' products or actual fabrication of devices using Laird Technologies' products. Accordingly, Laird Technologies cannot guarantee that the same test data as described herein will be obtained. Thus, it is recommended that each user make their own tests to confirm laboratory test data and determine suitability of Laird Technologies' products for their particular application.

The products described in this catalog shall be standard quality, however, the products in this catalog are sold without warranty of fitness for a particular purpose, either expressed or implied, except to the extent expressly stated on Laird Technologies' invoice, quotation or order acknowledgment. Laird Technologies does not warrant that devices incorporating one or more of the products described in this catalog will be free of conflict with existing or future patents of third parties. All risks of lack of fitness, patent infringement, and the like are assumed by the user. Furthermore, nothing contained herein shall be construed as a recommendation to make, use, or sell any product or process in conflict with existing or future patents.

We reserve the right to change technical specifications without notice and take no responsibility for errors and misprints.

Tolerances on inquiry.



As the world's leading fabricator of fingerstock, Laird Technologies has developed highly sophisticated and often proprietary technology necessary to achieve outstanding combinations of performance parameters in its shielding and grounding products. From a vast selection of product configurations, platings, and mounting techniques, to a full range of low compression force

requirements and high transfer impedance characteristics, there is a Laird Technologies gasket or grounding product just right for the job.

Depending upon the manufacturing process, some parts will be supplied with holes for cleaning and plating purposes. These holes will not affect the overall performance of the product.

Fingerstock Gaskets

Rivet Mount

Symmetrical Slotted Shielding (S ³)	15
Large Enclosure Series	15
Solid Top (S ³) Symmetrical Slotted Shielding Gasket	16

Slot Mount

Slot Mount Series	17
Variable Slot Mount	19

Sticky Fingers® PSA Tape Mounting

No Snag Gasket	20
Symmetrical Slotted Shielding (S ³)	21
Solid Top (S ³) Symmetrical Slotted Shielding Gasket	21
All-Purpose Gasket	22
Foldover Series	23
Low Profile Gasket	23
Twist Series	24
Low Profile Hook-On	25

Clip-On Mounting

Clip-On Gasket	26
Clip-On Twist Series	28
Clip-On Symmetrical Shielding Gasket	29
Mini Clip-On Symmetrical Shielding Gasket	29
Divider Edge Shield	30
Clip-On Perpendicular Shielding	30

Miscellaneous Mounting

Double-Sided Contact Strips	31
Flexible Low Compression Series	31

Metal Grounding Products

Clip-On Mounting

Clip-On Perpendicular Grounding Strip	33
Clip-On Longitudinal Grounding Strip	33
Card Guide Clip-On	34

Miscellaneous Mounting

Contact Strips	35
Contact Rings	39
Mini-Longitudinal Grounding Gasket	40
Longitudinal Grounding Series	40
Battery Contacts	41
Custom Stamping	43

Metal Connector Shields

Stainless Steel I/O Shielding	45
"D" Connector Series	45
DIN Connector Shield	46
IEEE 1394 Horizontal Connector Gasket	47
Fiber Optic Shield	48
GBIC Fiber Optic Shield	48
USB Type B Connector	49

Corrosion of EMI Gaskets

Metals Galvanic Compatibility Chart	51
--	----

Metals Galvanic Compatibility Chart





Fingerstock Gaskets

Symmetrical Slotted Shielding (S³)



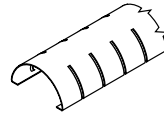
Page 15, 21

Large Enclosure Series



Page 15

Solid Top (S³)



Page 16, 21

Slot Mount Series



Page 17, 18

Variable Slot Mount



Page 19

No Snag Gasket



Page 20

All-Purpose Gasket



Page 22

Foldover Series



Page 23

Low Profile Gasket



Page 23

Twist Series



Page 24

Low Profile Hook-On



Page 25

Clip-On Gasket



Page 26, 27

Clip-On Twist Series



Page 28

Clip-On Symmetrical Shielding Gasket



Page 29

Mini Clip-On Symmetrical Shielding



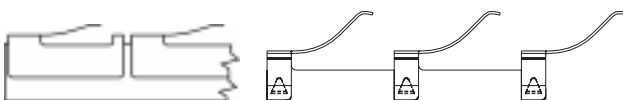
Page 29

Clip-On Perpendicular Shielding



Page 30

Divider Edge Shield



Page 30

Page 30

Double-Sided Contact Strips



Page 31

Flexible Low Compression Series



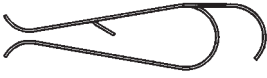
Page 31

All dimensions shown are in inches (millimeters) unless otherwise specified.
For availability see pages 6–11.



Metal Grounding Products

Clip-On Perpendicular Grounding Strip




Page 33

Clip-On Longitudinal Grounding Strip




Page 33

Card Guide Clip-On



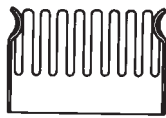
Page 34

Contact Strips



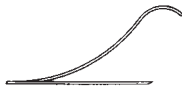
Page 35 – 38

Contact Rings




Page 39

Mini-Longitudinal Grounding Gasket



Page 40

Longitudinal Grounding Series



Page 40


Battery Contacts



Page 41, 42


Metal Connector Shields

Stainless Steel I/O Shielding



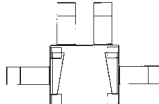
Page 45

“D” Connector Series




Page 45

DIN Connector Series



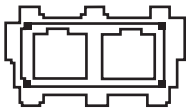
Page 46

IEEE 1394




Page 47

Fiber Optic Shield




Page 48

GBIC Fiber Optic Shield



Page 48

USB Type B Connector



Page 49



When ordering, please call our sales department to confirm availability and lead times.

Fingerstock Gaskets & Metal Grounding Products

Part No.	Product	Size	Page No.
400CO120	CLIP-ON PERPENDICULAR SHIELDING	2.322 (59) LENGTH	Page 30
400CO160	CLIP-ON PERPENDICULAR SHIELDING	1.063 (27) LENGTH	Page 30
77-010	SLOT MOUNT SERIES	16 (406) LENGTH	Page 17,18
77-011	SLOT MOUNT SERIES	16 (406) LENGTH	Page 17,18
77-012	NO SNAG GASKET	24 (610) LENGTH	Page 20
77-014	NO SNAG GASKET	24 (610) LENGTH	Page 20
77-015	SLOT MOUNT SERIES	SINGLE FINGER 0.250 (6,350)	Page 17,18
77-016	SLOT MOUNT SERIES	SINGLE FINGER 0.169 (4,293)	Page 18
77-017	SLOT MOUNT SERIES	TWO FINGERS 0.356 (9,042)	Page 18
77-018	SLOT MOUNT SERIES	THREE FINGERS 0.543 (13,792)	Page 17,18
77-019	SLOT MOUNT SERIES	FOUR FINGERS 0.730 (18,542)	Page 18
77-020	SLOT MOUNT SERIES	TWO FINGERS 0.532 (13,513)	Page 18
77-021	SLOT MOUNT SERIES	16 (406) LENGTH	Page 18
77-023	SLOT MOUNT SERIES	SINGLE FINGER 0.225 (5,715)	Page 18
77-024	SLOT MOUNT SERIES	TWO FINGERS 0.475 (12,065)	Page 18
77-025	SLOT MOUNT SERIES	THREE FINGERS 0.725 (18,415)	Page 18
77-026	SLOT MOUNT SERIES	FOUR FINGERS 0.975 (24,765)	Page 18
77-027	SLOT MOUNT SERIES	FIVE FINGERS 1.225 (31,115)	Page 18
77-028	SLOT MOUNT SERIES	SIX FINGERS 1.475 (37,460)	Page 18
77-029	SLOT MOUNT SERIES	SINGLE FINGER 0.343 (8,712)	Page 18
77-030	SLOT MOUNT SERIES	TWO FINGERS 0.718 (18,237)	Page 18
77-031	SLOT MOUNT SERIES	THREE FINGERS 1.093 (27,762)	Page 18
77-032	SLOT MOUNT SERIES	FOUR FINGERS 1.468 (37,287)	Page 18
77-033	NO SNAG GASKET	16 (406) LENGTH	Page 20
77-035	SLOT MOUNT SERIES	TWO FINGERS 0.480 (12,192)	Page 18
77-036	SLOT MOUNT SERIES	FOUR FINGERS 0.980 (24,892)	Page 18
77-037	SLOT MOUNT SERIES	SIX FINGERS 1.480 (37,592)	Page 18
77-038	SLOT MOUNT SERIES	EIGHT FINGERS 1.980 (50,292)	Page 18
77-039	SLOT MOUNT SERIES	SINGLE FINGER 0.169 (4,293)	Page 18
77-040	SLOT MOUNT SERIES	TWO FINGERS 0.356 (9,042)	Page 18
77-041	SLOT MOUNT SERIES	THREE FINGERS 0.543 (13,792)	Page 18
77-042	SLOT MOUNT SERIES	FOUR FINGERS 0.730 (18,542)	Page 18
77-043	LOW PROFILE GASKET	16 (406) LENGTH	Page 23
77-044	SLOT MOUNT SERIES	SIX FINGERS 1.104 (28,042)	Page 18
77-045	SLOT MOUNT SERIES	SINGLE FINGER 0.169 (4,293)	Page 18
77-046	SLOT MOUNT SERIES	TWO FINGERS 0.356 (9,042)	Page 18
77-047	SLOT MOUNT SERIES	THREE FINGERS 0.543 (13,792)	Page 18
77-048	SLOT MOUNT SERIES	FOUR FINGERS 0.730 (18,542)	Page 18
77-049	LOW PROFILE GASKET	16 (406) LENGTH	Page 23
77-050	SLOT MOUNT SERIES	FIVE FINGERS 0.917 (23,292)	Page 18
77-051	SLOT MOUNT SERIES	SIX FINGERS 1.104 (28,042)	Page 18
77-052	SLOT MOUNT SERIES	SEVEN FINGERS 1.291 (32,791)	Page 18
77-053	SLOT MOUNT SERIES	EIGHT FINGERS 1.478 (37,541)	Page 18
77-054	SLOT MOUNT SERIES	NINE FINGERS 1.665 (42,291)	Page 18
77-055	SLOT MOUNT SERIES	TEN FINGERS 1.852 (47,041)	Page 18

All dimensions shown are in inches (millimeters) unless otherwise specified.
For availability see pages 6-11.



Fingerstock Gaskets & Metal Grounding Products

Part No.	Product	Size	Page No.
77-056	VARIABLE SLOT MOUNT	16 (406) LENGTH	Page 18, 19
77-057	VARIABLE SLOT MOUNT	16 (406) LENGTH	Page 18, 19
77-058	SLOT MOUNT SERIES	FIVE FINGERS 0.917 (23,292)	Page 18
77-059	SLOT MOUNT SERIES	16 (406) LENGTH	Page 18
77-062	SLOT MOUNT SERIES	SINGLE FINGER 0.169 (4,293)	Page 18
77-063	SLOT MOUNT SERIES	TWO FINGERS 0.356 (9,042)	Page 18
77-064	SLOT MOUNT SERIES	THREE FINGERS 0.543 (13,792)	Page 18
77-065	SLOT MOUNT SERIES	FOUR FINGERS 0.730 (18,542)	Page 18
77-070	SLOT MOUNT SERIES	16 (406) LENGTH	Page 18
77-071	LOW PROFILE HOOK-ON	16.2 (411,5) LENGTH	Page 25
77-072	LOW PROFILE HOOK-ON	16.2 (411,5) LENGTH	Page 25
77-073	NO SNAG GASKET	24 (610) LENGTH	Page 20
77-074	NO SNAG GASKET	24 (610) LENGTH	Page 20
77-075	SLOT MOUNT SERIES	16 (406) LENGTH	Page 18
77-076	SLOT MOUNT SERIES	SINGLE FINGER 0.340 (8,636)	Page 18
77-078	NO SNAG GASKET	24 (610) LENGTH	Page 20
77-079	NO SNAG GASKET	16 (406) LENGTH	Page 20
77-080	NO SNAG GASKET	18 (457) LENGTH	Page 20
77-081	NO SNAG GASKET	24 (610) LENGTH	Page 20
77-082	NO SNAG GASKET	18 (457,2) LENGTH	Page 20
77-083	NO SNAG GASKET	16 (406) LENGTH	Page 20
77-084	NO SNAG GASKET	16 (406) LENGTH	Page 20
77-085	NO SNAG GASKET	18 (457) LENGTH	Page 20
77-089	SLOT MOUNT SERIES	THREE FINGERS 0.810 (20,574)	Page 18
77-092	NO SNAG GASKET	18 (457) LENGTH	Page 20
78-XXX	Most standard profiles are available in UltraSoft® low compression force (78 and 98) series. Please call our sales department for availability.		
95-702	GBIC FIBER OPTIC SHIELD		Page 48
95-822	"D" CONNECTOR SERIES	9 PIN BERYLLIUM COPPER	Page 45
95-823	"D" CONNECTOR SERIES	9 PIN BERYLLIUM COPPER	Page 45
95-824	"D" CONNECTOR SERIES	15 PIN BERYLLIUM COPPER	Page 45
95-825	"D" CONNECTOR SERIES	15 PIN BERYLLIUM COPPER	Page 45
95-826	"D" CONNECTOR SERIES	25 PIN BERYLLIUM COPPER	Page 45
95-827	"D" CONNECTOR SERIES	25 PIN BERYLLIUM COPPER	Page 45
95-828	"D" CONNECTOR SERIES	37 PIN BERYLLIUM COPPER	Page 45
95-829	"D" CONNECTOR SERIES	37 PIN BERYLLIUM COPPER	Page 45
95-1000	STAINLESS STEEL I/O SHIELDING		Page 45
97-076	FEMALE CONTACT RING	O.D. 0.640 (16,256)	Page 39
97-105	CONTACT STRIPS	16 (406) LENGTH	Page 35, 36
97-110	CONTACT STRIPS	16 (406) LENGTH	Page 35, 36
97-111	CONTACT STRIPS	16 (406) LENGTH	Page 35, 36
97-112	CONTACT STRIPS	16 (406) LENGTH	Page 35, 36
97-113	CONTACT STRIPS	16 (406) LENGTH	Page 35, 36
97-114	CONTACT STRIPS	16 (406) LENGTH	Page 35, 36
97-115	CONTACT STRIPS	16 (406) LENGTH	Page 35, 36
97-116	CONTACT STRIPS	16 (406) LENGTH	Page 35, 36
97-117	CONTACT STRIPS	16 (406) LENGTH	Page 35, 36

All dimensions shown are in inches (millimeters) unless otherwise specified.
For availability see pages 6–11.



Fingerstock Gaskets & Metal Grounding Products

Part No.	Product	Size	Page No.
97-134	CONTACT STRIPS	16 (406) LENGTH	Page 37, 38
97-135	CONTACT STRIPS	16 (406) LENGTH	Page 36
97-136	CONTACT STRIPS	16 (406) LENGTH	Page 37, 38
97-137	CONTACT STRIPS	16 (406) LENGTH	Page 37, 38
97-139	CONTACT STRIPS	16 (406) LENGTH	Page 37, 38
97-140	FEMALE CONTACT RING	O.D. 0.290 (7,366)	Page 39
97-141	FEMALE CONTACT RING	O.D. 0.440 (11,176)	Page 39
97-142	FEMALE CONTACT RING	O.D. 0.550 (13,970)	Page 39
97-143	FEMALE CONTACT RING	O.D. 0.800 (20,320)	Page 39
97-150	MALE CONTACT RING	I.D. 0.210 (5,334)	Page 39
97-151	MALE CONTACT RING	I.D. 0.330 (8,382)	Page 39
97-152	MALE CONTACT RING	I.D. 0.450 (11,430)	Page 39
97-153	MALE CONTACT RING	I.D. 0.690 (17,526)	Page 39
97-154	MALE CONTACT RING	I.D. 0.950 (24,130)	Page 39
97-155	MALE CONTACT RING	I.D. 1.450 (36,830)	Page 39
97-156	MALE CONTACT RING	I.D. 1.950 (49,530)	Page 39
97-185	FEMALE CONTACT RING	O.D. 0.560 (14,224)	Page 39
97-192	MALE CONTACT RING	I.D. 0.450 (11,430)	Page 39
97-204	FEMALE CONTACT RING	O.D. 1.040 (26,416)	Page 39
97-205	MALE CONTACT RING	I.D. 0.890 (22,606)	Page 39
97-210	CONTACT STRIPS	12 (305) LENGTH	Page 38
97-211	CONTACT STRIPS	12 (305) LENGTH	Page 38
97-215	MALE CONTACT RING	I.D. 1.240 (31,496)	Page 39
97-216	FEMALE CONTACT RING	O.D. 1.240 (31,496)	Page 39
97-221	CONTACT STRIPS	12 (305) LENGTH	Page 36
97-223	CONTACT STRIPS	16 (406) LENGTH	Page 37, 38
97-232	FEMALE CONTACT RING	O.D. 0.540 (13,716)	Page 39
97-241	MALE CONTACT RING	I.D. 0.340 (8,36)	Page 39
97-251	CONTACT STRIPS	12 (305) LENGTH	Page 36
97-252	FEMALE CONTACT RING	O.D. 1.250 (31,750)	Page 39
97-254	FEMALE CONTACT RING	O.D. 0.910 (23,114)	Page 39
97-255	FEMALE CONTACT RING	O.D. 0.650 (16,510)	Page 39
97-290	CONTACT STRIPS	16 (406) LENGTH	Page 37, 38
97-300	CONTACT STRIPS	16 (406) LENGTH	Page 35, 36
97-310	CONTACT STRIPS	15 (381) LENGTH	Page 36
97-320	CONTACT STRIPS	16 (406) LENGTH	Page 37, 38
97-330	CONTACT STRIPS	16 (406) LENGTH	Page 37, 38
97-340	CONTACT STRIPS	16 (406) LENGTH	Page 36
97-342	CONTACT STRIPS	16 (406) LENGTH	Page 36
97-360	CONTACT STRIPS	16 (406) LENGTH	Page 37, 38
97-361	FEMALE CONTACT RING	O.D. 1.010 (25,654)	Page 39
97-370	CONTACT STRIPS	16 (406) LENGTH	Page 38
97-380	CONTACT STRIPS	16 (406) LENGTH	Page 37, 38
97-381	FEMALE CONTACT RING	O.D. 1.210 (30,734)	Page 39
97-390	CONTACT STRIPS	16 (406) LENGTH	Page 36
97-410	CONTACT STRIPS	16 (406) LENGTH	Page 37, 38
97-420	FEMALE CONTACT RING	O.D. 0.500 (12,700)	Page 39
97-421	FEMALE CONTACT RING	O.D. 0.500 (12,700)	Page 39

All dimensions shown are in inches (millimeters) unless otherwise specified. For availability see pages 6-11.



Fingerstock Gaskets & Metal Grounding Products

Part No.	Product	Size	Page No.
97-422	FEMALE CONTACT RING	O.D. 0.600 (15,240)	Page 39
97-423	FEMALE CONTACT RING	O.D. 0.780 (19,812)	Page 39
97-424	FEMALE CONTACT RING	O.D. 1.050 (26,670)	Page 39
97-430	CONTACT STRIPS	16 (406) LENGTH	Page 38
97-435	90 DEGREE CORNER		Page 31
97-436	DOUBLE-SIDED CONTACT STRIPS	25' (7,6 m) COILS	Page 31
97-438	LARGE ENCLOSURE SERIES	25' (7,6 m) COILS	Page 15
97-440	LARGE ENCLOSURE SERIES	25' (7,6 m) COILS	Page 15
97-445	QUICK SPRING CLIP FASTENER		Page 31
97-487	BATTERY CONTACTS		Page 41
97-488	BATTERY CONTACTS		Page 41
97-489	BATTERY CONTACTS		Page 42
97-490	BATTERY CONTACTS		Page 42
97-500	ALL-PURPOSE GASKET	24 (610) LENGTH	Page 22
97-505	ALL-PURPOSE GASKET	24 (610) LENGTH	Page 22
97-510	ALL-PURPOSE GASKET	24 (610) LENGTH	Page 22
97-515	FOLDOVER SERIES	24 (610) LENGTH	Page 23
97-520	ALL-PURPOSE GASKET	16 (406) LENGTH	Page 22
97-521	FOLDOVER SERIES	16 (406) LENGTH	Page 23
97-525	ALL-PURPOSE GASKET	16 (406) LENGTH	Page 22
97-535	ALL-PURPOSE GASKET	12 (305) LENGTH	Page 22
97-536	ALL-PURPOSE GASKET	24 (610) LENGTH	Page 22
97-537	ALL-PURPOSE GASKET	12 (305) LENGTH	Page 22
97-538	ALL-PURPOSE GASKET	24 (610) LENGTH	Page 22
97-540	ALL-PURPOSE GASKET	16 (406) LENGTH	Page 22
97-541	FOLDOVER SERIES	16 (406) LENGTH	Page 23
97-542	FOLDOVER SERIES	16 (406) LENGTH	Page 23
97-544	ALL-PURPOSE GASKET	16 (406) LENGTH	Page 22
97-545	ALL-PURPOSE GASKET	12 (305) LENGTH	Page 22
97-547	TWIST SERIES	24 (610) LENGTH	Page 24
97-548	ALL-PURPOSE GASKET	24 (610) LENGTH	Page 22
97-550	TWIST SERIES	24 (610) LENGTH	Page 24
97-551	TWIST SERIES	24 (610) LENGTH	Page 24
97-552	CLIP-ON TWIST SERIES	16 (406) LENGTH	Page 28
97-553	CLIP-ON TWIST SERIES	16 (406) LENGTH	Page 28
97-555	TWIST SERIES	24 (610) LENGTH	Page 24
97-556	TWIST SERIES	24 (610) LENGTH	Page 24
97-558	TWIST SERIES	24 (610) LENGTH	Page 24
97-559	TWIST SERIES	24 (610) LENGTH	Page 24
97-560	TWIST SERIES	24 (610) LENGTH	Page 24
97-561	TWIST SERIES	24 (610) LENGTH	Page 24
97-563	CLIP-ON TWIST SERIES	16 (406) LENGTH	Page 28
97-564	CLIP-ON TWIST SERIES	16 (406) LENGTH	Page 28
97-567	TWIST SERIES	24 (610) LENGTH	Page 24
97-568	CLIP-ON TWIST SERIES	16 (406) LENGTH	Page 28
97-569	TWIST SERIES	24 (610) LENGTH	Page 24
97-572	CLIP-ON TWIST SERIES	16 (406) LENGTH	Page 28
97-573	CLIP-ON TWIST SERIES	16 (406) LENGTH	Page 28

All dimensions shown are in inches (millimeters) unless otherwise specified. For availability see pages 6-11.





Fingerstock Gaskets & Metal Grounding Products

Part No.	Product	Size	Page No.
97-574	CLIP-ON TWIST SERIES	16 (406) LENGTH	Page 28
97-575	CLIP-ON TWIST SERIES	16 (406) LENGTH	Page 28
97-576	CLIP-ON TWIST SERIES	16 (406) LENGTH	Page 28
97-577	CLIP-ON TWIST SERIES	16 (406) LENGTH	Page 28
97-578	CLIP-ON TWIST SERIES	16 (406) LENGTH	Page 28
97-579	CLIP-ON TWIST SERIES	16 (406) LENGTH	Page 28
97-580	CLIP-ON TWIST SERIES	16 (406) LENGTH	Page 28
97-581	CLIP-ON TWIST SERIES	16 (406) LENGTH	Page 28
97-582	CLIP-ON TWIST SERIES	16 (406) LENGTH	Page 28
97-583	CLIP-ON TWIST SERIES	16 (406) LENGTH	Page 28
97-584	CLIP-ON TWIST SERIES	16 (406) LENGTH	Page 28
97-585	CLIP-ON TWIST SERIES	16 (406) LENGTH	Page 28
97-586	CLIP-ON TWIST SERIES	16 (406) LENGTH	Page 28
97-587	CLIP-ON TWIST SERIES	16 (406) LENGTH	Page 28
97-589	CLIP-ON TWIST SERIES	24 (610) LENGTH	Page 28
97-603	CLIP-ON GASKET	16 (406) LENGTH	Page 26, 27
97-604	CLIP-ON GASKET	16 (406) LENGTH	Page 26, 27
97-605	CLIP-ON GASKET	16 (406) LENGTH	Page 26, 27
97-606	CLIP-ON GASKET	16 (406) LENGTH	Page 26, 27
97-607	CLIP-ON GASKET	16 (406) LENGTH	Page 26, 27
97-610	CLIP-ON GASKET	16 (406) LENGTH	Page 26, 27
97-611	CLIP-ON GASKET	16 (406) LENGTH	Page 26, 27
97-612	CLIP-ON GASKET	16 (406) LENGTH	Page 26, 27
97-613	CLIP-ON GASKET	16 (406) LENGTH	Page 26, 27
97-614	CLIP-ON GASKET	16 (406) LENGTH	Page 26, 27
97-619	CLIP-ON GASKET	16 (406) LENGTH	Page 26, 27
97-620	CLIP-ON GASKET	16 (406) LENGTH	Page 26, 27
97-621	CLIP-ON GASKET	16 (406) LENGTH	Page 26, 27
97-622	CLIP-ON GASKET	16 (406) LENGTH	Page 26, 27
97-628	CLIP-ON GASKET	16 (406) LENGTH	Page 26, 27
97-629	CLIP-ON GASKET	16 (406) LENGTH	Page 26, 27
97-630	CLIP-ON GASKET	16 (406) LENGTH	Page 26, 27
97-631	CLIP-ON GASKET	16 (406) LENGTH	Page 26, 27
97-632	CLIP-ON GASKET	16 (406) LENGTH	Page 26, 27
97-633	CLIP-ON GASKET	16 (406) LENGTH	Page 26, 27
97-634	CLIP-ON GASKET	16 (406) LENGTH	Page 26, 27
97-636	MINI CLIP-ON SYMMETRICAL SHIELDING GASKET	16.15 (410,2) LENGTH	Page 29
97-637	CLIP-ON SYMMETRICAL SHIELDING GASKET	16.5 (420) LENGTH	Page 29
97-640	CLIP-ON GASKET	16 (406) LENGTH	Page 26, 27
97-645	CLIP-ON GASKET	24 (610) LENGTH	Page 26, 27
97-646	CLIP-ON GASKET	16 (406) LENGTH	Page 27
97-650	CLIP-ON GASKET	16 (406) LENGTH	Page 26, 27
97-654	DIVIDER EDGE SHIELD	12 (305) LENGTH	Page 30
97-655	CLIP-ON PERPENDICULAR GROUNDING STRIP	12 (305) LENGTH	Page 33
97-656	CLIP-ON PERPENDICULAR SHIELDING	16 (406) LENGTH	Page 30
97-723	DIN CONNECTOR SERIES		Page 46
97-725	DIN CONNECTOR SERIES		Page 46
97-727	FIBER OPTIC SHIELDING		Page 48

All dimensions shown are in inches (millimeters) unless otherwise specified. For availability see pages 6-11.



Fingerstock Gaskets & Metal Grounding Products

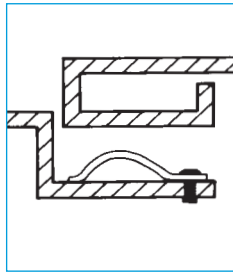
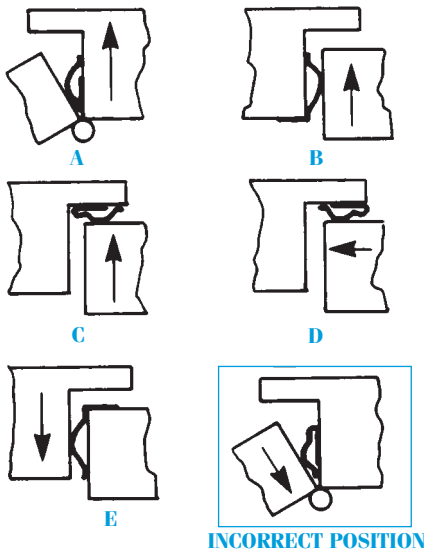
Part No.	Product	Size	Page No.
97-728	USB CONNECTOR GASKET		Page 49
97-768	"D" CONNECTOR SERIES	9 PIN STAINLESS STEEL	Page 45
97-769	"D" CONNECTOR SERIES	15 PIN STAINLESS STEEL	Page 45
97-770	"D" CONNECTOR SERIES	25 PIN STAINLESS STEEL	Page 45
97-771	"D" CONNECTOR SERIES	37 PIN STAINLESS STEEL	Page 45
97-772	"D" CONNECTOR SERIES	50 PIN STAINLESS STEEL	Page 45
97-773	"D" CONNECTOR SERIES	68 PIN STAINLESS STEEL	Page 45
97-778	"D" CONNECTOR SERIES	9 PIN BERYLLIUM COPPER	Page 45
97-779	"D" CONNECTOR SERIES	15 PIN BERYLLIUM COPPER	Page 45
97-780	"D" CONNECTOR SERIES	25 PIN BERYLLIUM COPPER	Page 45
97-781	"D" CONNECTOR SERIES	37 PIN BERYLLIUM COPPER	Page 45
97-782	"D" CONNECTOR SERIES	50 PIN BERYLLIUM COPPER	Page 45
97-783	"D" CONNECTOR SERIES	68 PIN BERYLLIUM COPPER	Page 45
97-786	IEEE 1394 HORIZONTAL CONNECTOR GASKET	Page 47	
97-787	IEEE 1394 HORIZONTAL CONNECTOR GASKET		Page 47
97-822	"D" CONNECTOR SERIES	9 PIN BERYLLIUM COPPER	Page 45
97-823	"D" CONNECTOR SERIES	9 PIN BERYLLIUM COPPER	Page 45
97-824	"D" CONNECTOR SERIES	15 PIN BERYLLIUM COPPER	Page 45
97-825	"D" CONNECTOR SERIES	15 PIN BERYLLIUM COPPER	Page 45
97-826	"D" CONNECTOR SERIES	25 PIN BERYLLIUM COPPER	Page 45
97-827	"D" CONNECTOR SERIES	25 PIN BERYLLIUM COPPER	Page 45
97-828	"D" CONNECTOR SERIES	37 PIN BERYLLIUM COPPER	Page 45
97-829	"D" CONNECTOR SERIES	37 PIN BERYLLIUM COPPER	Page 45
97-910	SOLID TOP SYMMETRICAL SLOTTED SHIELDING	15 (381) LENGTH	Page 21
97-913	SOLID TOP SYMMETRICAL SLOTTED SHIELDING	15 (381) LENGTH	Page 16
97-915	SOLID TOP SYMMETRICAL SLOTTED SHIELDING	15 (381) LENGTH	Page 21
97-916	SOLID TOP SYMMETRICAL SLOTTED SHIELDING	15 (381) LENGTH	Page 16
97-918	SOLID TOP SYMMETRICAL SLOTTED SHIELDING	15 (381) LENGTH	Page 21
97-919	SOLID TOP SYMMETRICAL SLOTTED SHIELDING	15 (381) LENGTH	Page 16
97-921	FLEXIBLE LOW COMPRESSION SERIES	24 (610) LENGTH	Page 31
97-941	FLEXIBLE LOW COMPRESSION SERIES	24 (610) LENGTH	Page 31
97-951	SYMMETRICAL SLOTTED SHIELDING	15 (381) LENGTH	Page 21
97-952	SYMMETRICAL SLOTTED SHIELDING	15 (381) LENGTH	Page 15
97-954	SYMMETRICAL SLOTTED SHIELDING	15 (381) LENGTH	Page 21
97-955	SYMMETRICAL SLOTTED SHIELDING	15 (381) LENGTH	Page 15
97-957	SYMMETRICAL SLOTTED SHIELDING	15 (381) LENGTH	Page 21
97-958	SYMMETRICAL SLOTTED SHIELDING	15 (381) LENGTH	Page 15
97-964	RETENTION CLIP		Page 16
97-965	RETENTION CLIP		Page 16
97-966	RETENTION CLIP		Page 16
97-972	DIVIDER EDGE SHIELD	12 (305) LENGTH	Page 30
97-973	CARD GUIDE CLIP-ON		Page 34
97-974	MINI-LONGITUDINAL GROUNDING GASKET	16 (406) LENGTH	Page 40
97-975	LONGITUDINAL GROUNDING SERIES	18.75 (476,3) LENGTH	Page 40
97-976	CLIP-ON LONGITUDINAL GROUNDING STRIP	17 (433) LENGTH	Page 33
97-983	CARD GUIDE CLIP-ON		Page 34
98-XXX	Most standard profiles are available in UltraSoft® low compression force (78 and 98) series. Please call our sales department for availability.		

All dimensions shown are in inches (millimeters) unless otherwise specified. For availability see pages 6-11.

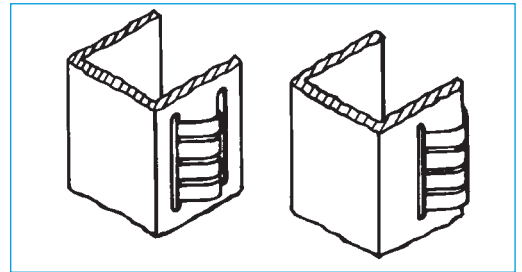




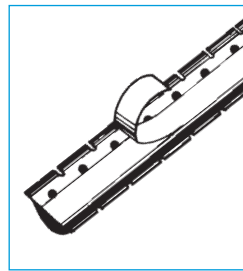
Mounting Methods



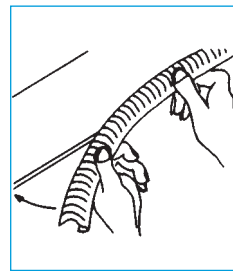
Rivet Mount



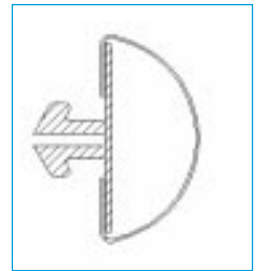
Slot Mount



Sticky Fingers®



Clip-On Mounting



Universal Mounting

Shielding gaskets may be mounted for either wiping or compression closing applications. Proper positioning of the shielding gasket must take into consideration the closing design and the configuration of the mounting surface.

Laird Technologies shielding devices may be mounted quickly and easily using any of several different methods. Each installation method is described in the text that follows. However, if you should run into a unique situation not resolved by any of these methods, give us a call. Chances are we can provide the exact answer you need.

Rivet Mount

Riveting produces a tight, long-lasting installation. Either plastic or metal rivets may be used.

Slot Mount

Slot mounted parts are easily installed using slots where bi-directional movement is required. Simply install part into one slot, and snap it into the second slot or over the edge of the frame.

Adhesive Mounting

Sticky Fingers® is an instant, pressure-sensitive adhesive bonding system, ideal for all-purpose contact strips for metal cabinets and electronic enclosures, and is unaffected by temperatures from -67 to +250°F (-55 to +121°C).

Simply follow these four easy steps:

1. Remove all grease and oily residue with solvent. Smooth the mounting surface with emery cloth.
2. Peel off protective paper backing.
3. Place gasket in correct position. (See diagrams A through E.) Press firmly to ensure a good adhesive bond. Avoid repositioning, which might impair the effectiveness of the adhesive or may bend or kink the strip. NOTE: On items where fingers cover the solid portion of the gasket, pressure may be applied

by inserting a mandrel in the strip and pressing down. For contact strips with Magnefil® insert, simply press down on the fingers.

4. Allow 24 hours minimum curing time.

Standard parts are supplied with nonconductive tape. For rough surface applications, such as flame sprayed surfaces, 0.010 in. (0,25 mm) thick nonconductive tape is recommended. Optional conductive tape is also available. Contact a sales department representative for additional ordering information.

Clip-On Mounting

Clip-on gaskets hold firmly in place due to their own spring characteristics. Simply push the strips onto the edge or flange of the door or enclosure. Also available are clip-on gaskets with either "T" lances or "D" lances.

Universal Mounting

A stainless steel mounting track is available for use with our full line of gasketing materials. Its unique design offers a secure mounting option versatile enough for use with fingerstock, ElectroNit® mesh, ElectroSeal elastomers, Ultra Soft Knit, and fabric over foam products.

Welding

Welded mounting requires simple, traditional welding techniques.

Soldering

Solder mounting requires normal low temperature soldering techniques, including cleaning and fluxing of parts with common copper flux materials.



Part Number Format:

Example:

Stock Item **Unique Part No.** **Finish I.D.**
0097 – 0520 – 02

- In the above example, Laird Technologies part number 0097-0520-02 is a 97-520 RFI/EMI shielding gasket with a bright finish
- When ordering UltraSoft® items, the stock item prefix will be 0098 or 0078. The above example in UltraSoft would be 0098-0520-02.
- When ordering coil, the prefix 0C should precede the stock item number; for example: 0C97, 0C98, 0C77, or 0C78
- When ordering stainless steel items, the stock item prefix will be 0095
- Standard plating finish is 0.0001 in. (0,0025 mm) min. [gold 0.00005 in. (0,0013 mm) min.] but can be varied to meet your custom needs
- Modifications to standard parts are specified by an X (following finish I.D.) for quoting only. Upon ordering, a specific part number will be assigned.
- For tape options, see Adhesive Mounting – Sticky Fingers® on page 12
- Use the catalog number for the unique part number, and refer to the following chart for finish I.D.

Plating Finishes

Required Finish	Finish	Specifications	I.D. #
Bright Finish	—	—	02
Solderable Unplated	—	—	21
Gold	Gold	ASTM B-488/SAE AMS 2422	03
	Nickel Underplate	QQ-N-290 / ASTM B-488	10
	Gold Contips®	ASTM B-488/SAE AMS 2422	13
	Gold Contips / Gold Plate	ASTM B-488 / SAE AMS 2422	14
Silver	Silver	ASTM B-700	04
	Silver Contips	ASTM B-700	11
	Silver Contips / Plating	ASTM B-700	12
	Silver Plate / Gold Contips	ASTM B-700/ASTM B-488	20
Cadmium	Yellow Chromate	QQ-P-416	05
	Clear Chromate	QQ-P-416	06
Tin Lead*	Solder	SAE AMS-P-81728	07
Nickel	Dull	QQ-N-290	09
	Bright	QQ-N-290	19
	Engineering (Sulfamate)	SAE AMS 2424	24
Electroless Nickel	Mid Phos Electroless Nickel	MIL-C-26074	18
Tin	Satin	ASTM B-545	08
	Bright	ASTM B-545	17
Zinc	Yellow Chromate	SAE AMS 2402	16
	Clear Chromate	SAE AMS 2402	15
Rhodium	Rhodium	ASTM B-634	22
Stainless Steel	Passivation	SAE AMS QQ-P-35	—

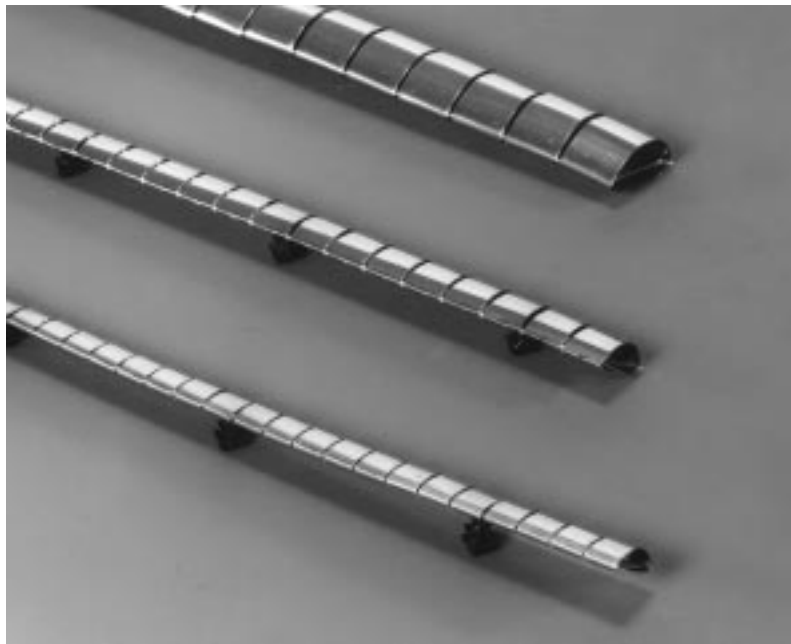
*Not recommended for Foldover Series.

Note: Refer to page 54 for Metals Galvanic Compatibility Chart.





Fingerstock Gaskets



Rivet Mount

Symmetrical Slotted Shielding (S ³)	15
Large Enclosure Series	15
Solid Top (S ³) Symmetrical Slotted Shielding Gasket	16

Slot Mount

Slot Mount Series	17
Variable Slot Mount	19

Sticky Fingers® PSA Tape Mounting

No Snag Gasket	20
Symmetrical Slotted Shielding (S ³)	21
Solid Top (S ³) Symmetrical Slotted Shielding Gasket	21
All-Purpose Gasket	22
Foldover Series	23
Low Profile Gasket	23

Twist Series	24
--------------	----

Low Profile Hook-On	25
---------------------	----

Clip-On Mounting

Clip-On Gasket	26
----------------	----

Clip-On Twist Series	28
----------------------	----

Clip-On Symmetrical Shielding Gasket	29
--------------------------------------	----

Mini Clip-On Symmetrical Shielding Gasket	29
---	----

Divider Edge Shield	30
---------------------	----

Clip-On Perpendicular Shielding	30
---------------------------------	----

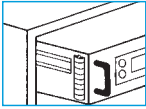
Miscellaneous Mounting

Double-Sided Contact Strips	31
-----------------------------	----

Flexible Low Compression Series	31
---------------------------------	----

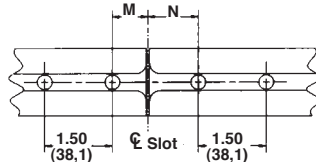
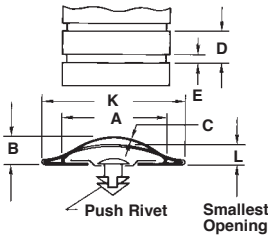


Rivet Mount Symmetrical Slotted Shielding (S³)

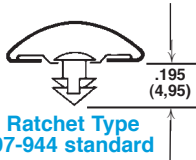


- A wide radius profile creates the greatest contact for maximum conductivity
- Rivet mount version is designed especially for sliding applications with bi-directional engagement
- Available in both Sticky Fingers® and rivet mount

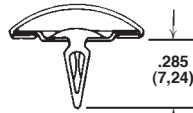
S³ Rivet Mount



Rivet Spacing
Rivets UL 94 rating:
Black HB; White V-2



Ratchet Type
97-944 standard



Tapered Type 97-950
optional; 97-945
White Rivet available
only on part # 97-958

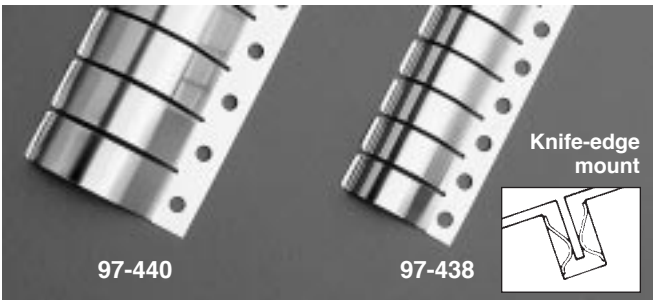


S³ Series — Rivet Mount

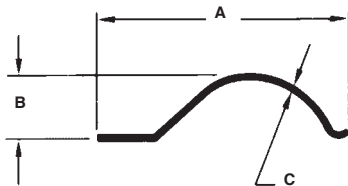
Series	A	B Min.	C	D	E	K	L	Approx. Length	M	N	No. of Rivets
97-952	0.620 (15,748)	0.220 (5,588)	0.004 (0,102)	0.375 (9,525)	0.030 (0,762)	0.760 (19,304)	0.100 (2,540)	15.000 (381,000)	0.560 (14,224)	0.940 (23,876)	10 —
97-955	0.450 (11,430)	0.140 (3,556)	0.003 (0,076)	0.250 (6,350)	0.022 (0,559)	0.510 (12,954)	0.070 (1,778)	15.000 (381,000)	0.630 (16,002)	0.880 (22,352)	10 —
97-958	0.350 (8,890)	0.110 (2,794)	0.003 (0,076)	0.187 (4,750)	0.018 (0,457)	0.380 (9,652)	0.070 (1,778)	15.000 (381,000)	0.660 (16,764)	0.840 (21,336)	10 —



Rivet Mount Large Enclosure Series

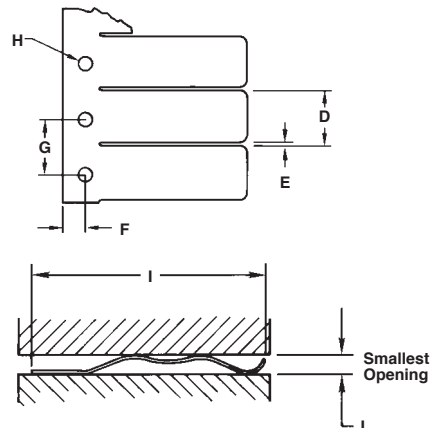


- Mounting methods include screws, rivets or soldering
- Ideal for larger enclosures using knife-edge design
- Available in continuous lengths of 25-foot (7,6 m) coils



Large Enclosure Series

Series	A Ref.	B Min.	C	D	E	F	G	H Dia.	I	L	Approx. Length ft. (m)
97-438	1.090 (27,686)	0.250 (6,350)	0.005 (0,127)	0.375 (9,525)	0.040 (1,016)	0.160 (4,064)	0.380 (9,652)	0.140 (3,556)	1.270 (32,258)	0.080 (2,032)	25.000 (7,6)
97-440	1.630 (41,402)	0.410 (10,414)	0.007 (0,178)	0.500 (12,700)	0.040 (1,016)	0.190 (4,826)	0.500 (12,700)	0.140 (3,556)	1.900 (48,260)	0.100 (2,540)	25.000 (7,6)



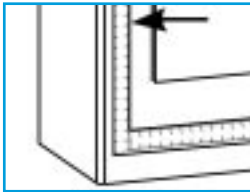
All dimensions shown are in inches (millimeters) unless otherwise specified.
For availability see pages 6–11.



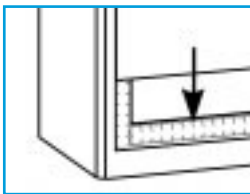
Rivet Mount

Solid Top (S³) Symmetrical Slotted Shielding Gasket

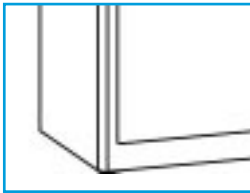
- The solid top design allows the engaging panel or door to slide either perpendicularly or parallel to the fingerstock
- Shorter slot provides improved shielding effectiveness (100 dB)
- Offered in both rivet mount and tape mount versions



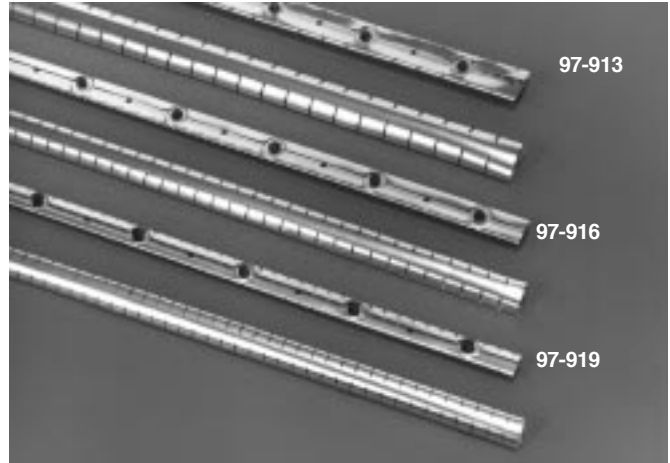
View A — A computer tower side panel is moved sideways during the first step of installation.



View B — Next, the panel is moved downwards, sliding longitudinally on the vertical finger gasket.



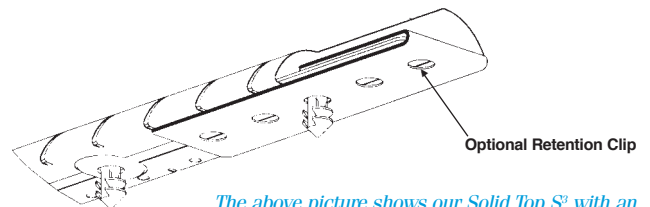
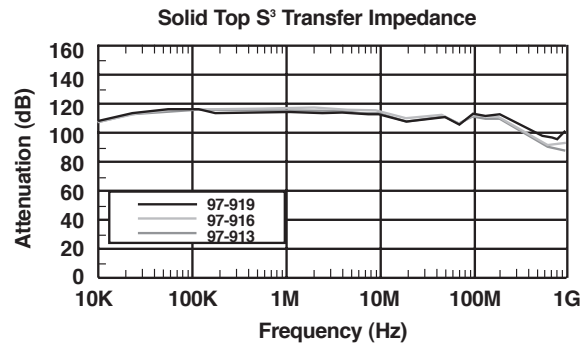
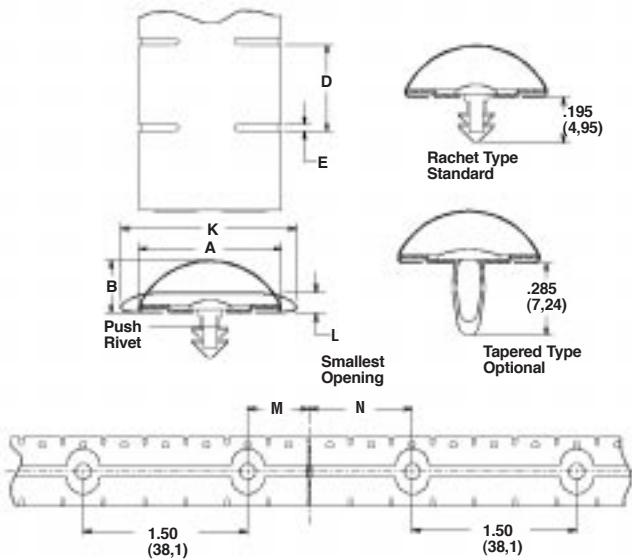
View C — Fully installed panel is now compressing both finger gaskets.



Solid Top S³ Series — Rivet Mount

Series	A Min.	B	C	D	E	K	L	Approx. Length	M	N	No. of Rivets
97-913	0.620 (15,748)	0.220 (5,588)	0.004 (0,102)	0.375 (9,525)	0.030 (0,762)	0.760 (19,304)	0.100 (2,540)	15,000 (381,000)	0.560 (14,224)	0.940 (23,876)	10 —
97-916	0.450 (11,430)	0.140 (3,556)	0.003 (0,076)	0.250 (6,350)	0.022 (0,559)	0.510 (12,954)	0.070 (1,778)	15,000 (381,000)	0.630 (16,002)	0.880 (22,352)	10 —
97-919	0.350 (8,890)	0.110 (2,794)	0.003 (0,076)	0.187 (4,750)	0.018 (0,457)	0.380 (9,652)	0.070 (1,778)	15,000 (381,000)	0.660 (16,764)	0.840 (21,336)	10

Retention Clip Part No.		Rivet Mount Part No.
97-964	Used On	97-919
97-965	Used On	97-916
97-966	Used On	97-913

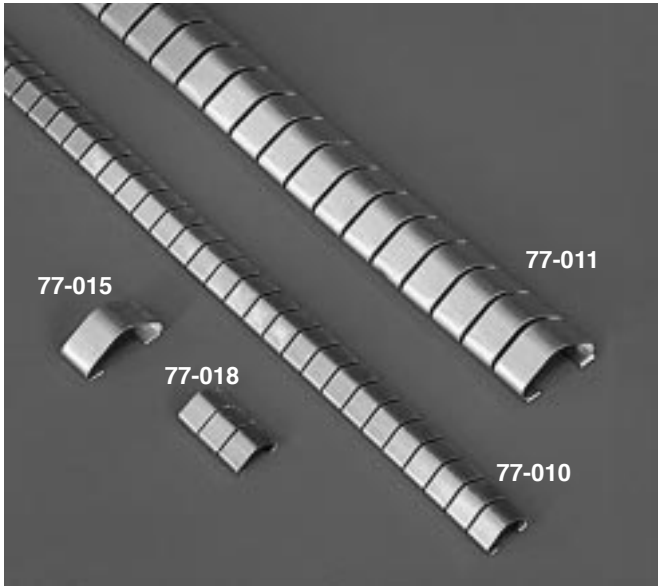


The above picture shows our Solid Top S³ with an optional retention clip. This clip is designed to ensure secure retention of actual fingerstock to track component.

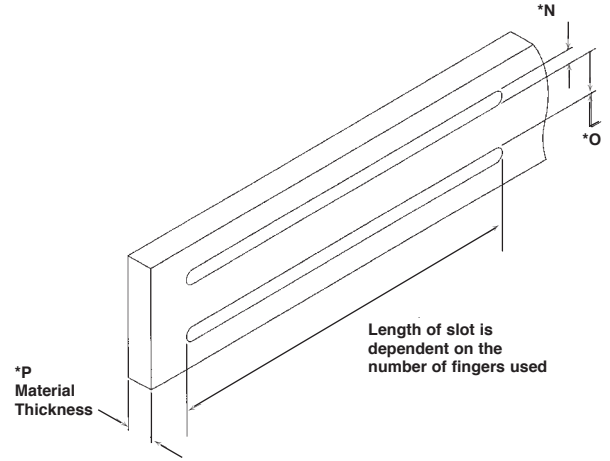
All dimensions shown are in inches (millimeters) unless otherwise specified.
For availability see pages 6–11.



Slot Mount Series

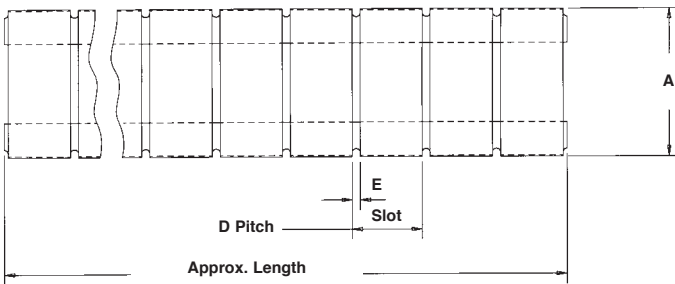


- Available in six profile sizes in virtually any number of fingers configuration
- Designed for slotted enclosures, eliminating need for fasteners or PSA Tape
- Ideal for bi-directional wiping applications

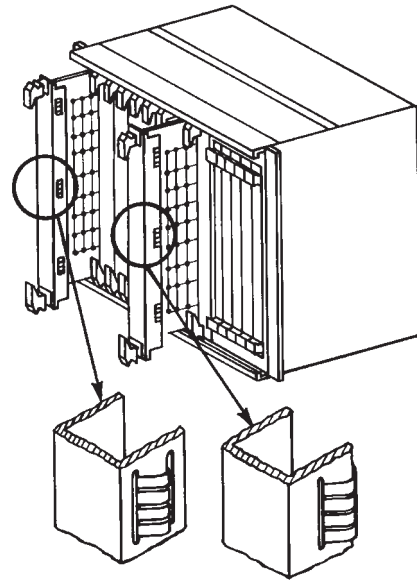
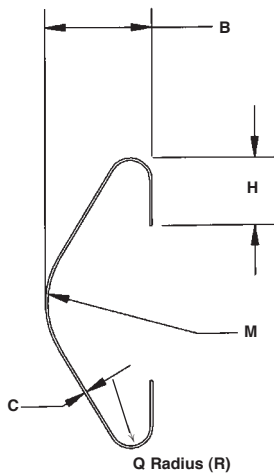


Recommended Mounting Hole Pattern

Top View



Right View

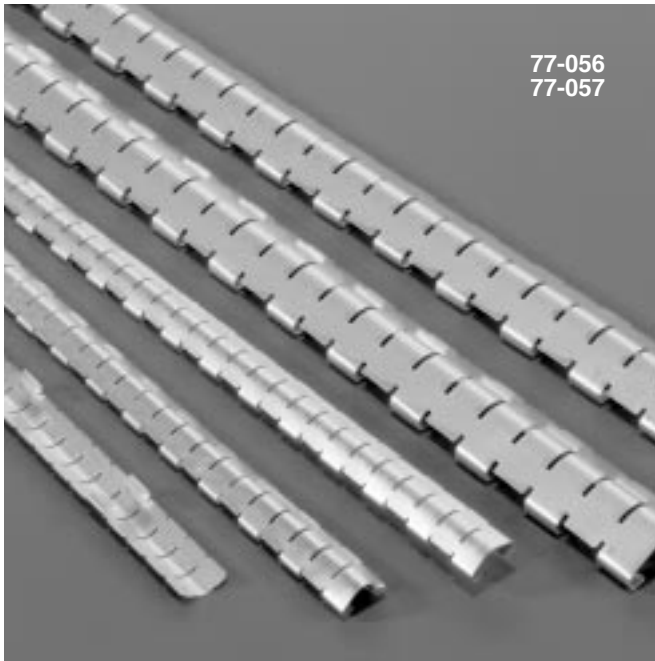


See page 18 for dimensions.

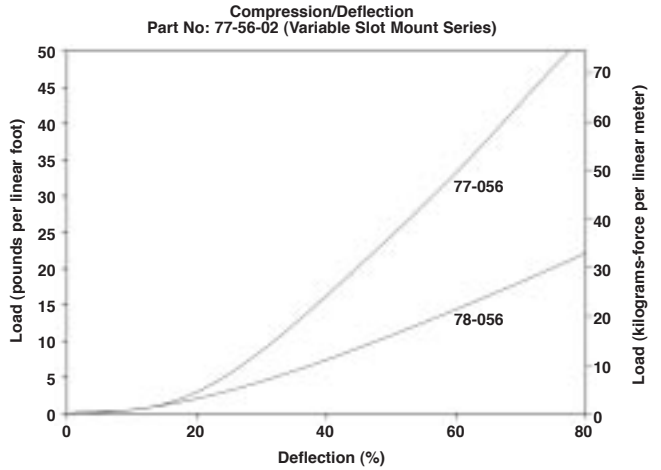
All dimensions shown are in inches (millimeters) unless otherwise specified.
For availability see pages 6-11.



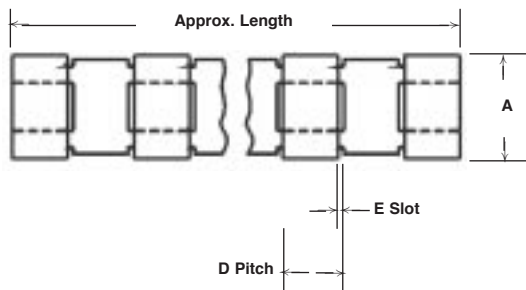
Slot Mount Variable Slot Mount



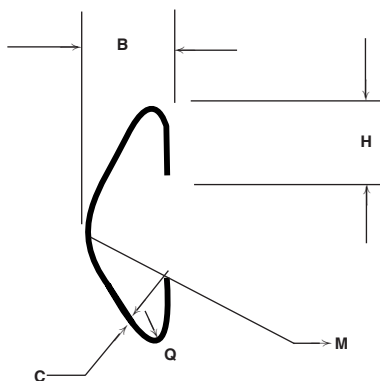
- Improved shielding effectiveness while utilizing the easy slot mount installation method
- Slot mounting feature can be varied to accommodate different length and hole mounting patterns



Front View



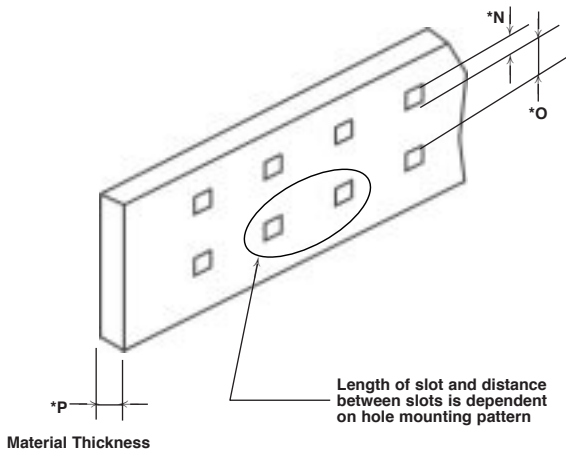
Right View



Variable Slot Mount Series Dimensions

Series	A	B	C	D	E	H	M	*Recommended			Q (R)	Approx. Length	# of Fing.
								*N	*O	*P			
77-056	0.320	0.110	0.004	0.187	0.018	0.085	0.110	0.090	0.260	0.040	0.020	16,000	86
	(8,128)	(2,794)	(0,102)	(4,750)	(0,457)	(2,159)	(2,794)	(2,286)	(6,604)	(1,016)	(0,508)	(406,400)	—
77-057	0.600	0.220	0.005	0.282	0.032	0.130	0.180	0.140	0.520	0.070	0.040	16,000	57
	(15,240)	(5,588)	(0,127)	(7,163)	(0,813)	(3,302)	(4,572)	(3,556)	(13,208)	(1,778)	(1,016)	(406,400)	—

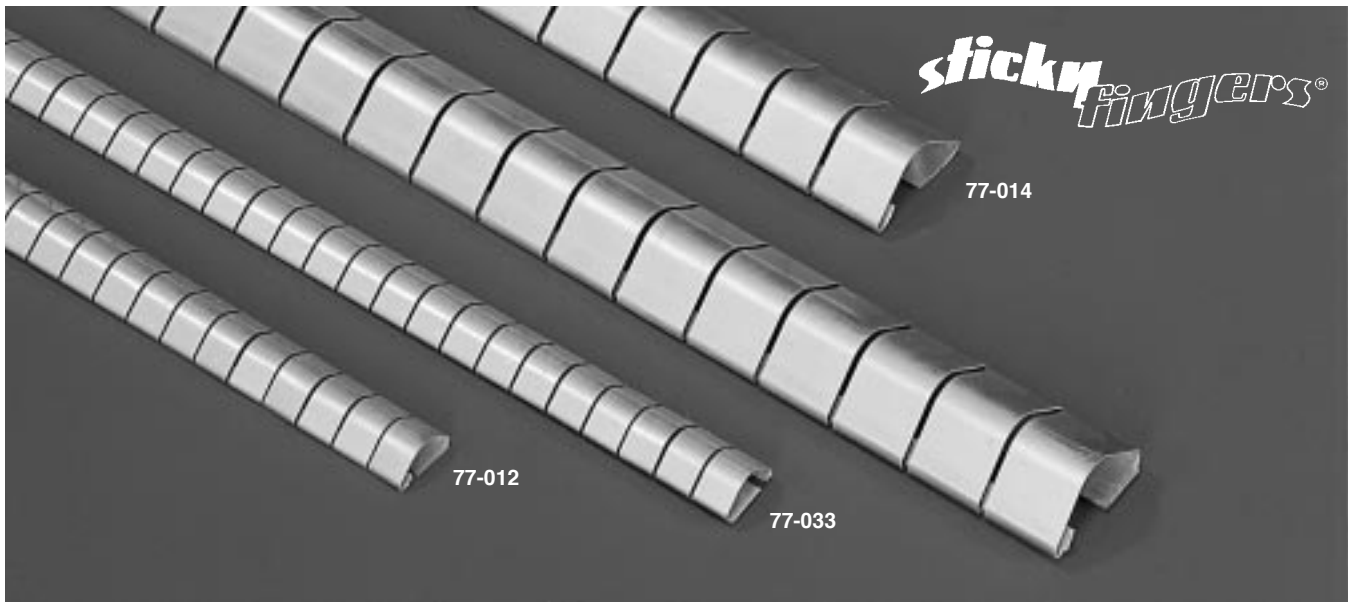
* May vary depending upon application



All dimensions shown are in inches (millimeters) unless otherwise specified.
For availability see pages 6–11.



Sticky Fingers® Pressure Sensitive Tape (PSA) Mount No Snag Gasket



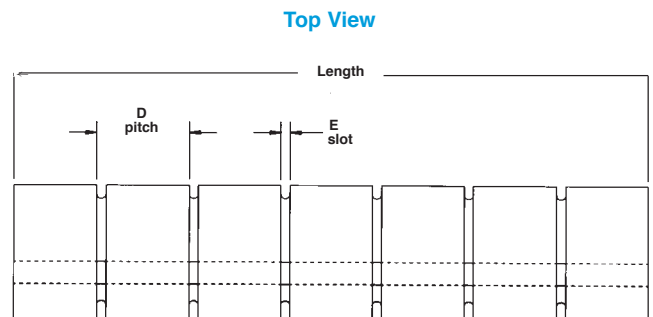
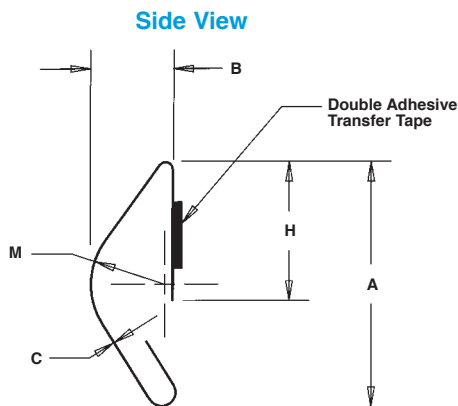
- Shielding effectiveness of >100 dB (77-012) and > 80 dB (77-014) for a 100 MHz plane wave
- Easy, cost-effective installation since fasteners are not required
- Ideal as an all-purpose contact strip for metal cabinets and electronic enclosures
- Available in a wide variety of plated finishes, see page 13
- Supplied in standard 24 in. (610 mm) lengths or other specified lengths

Style 77-014 is available in UltraSoft® low compression force version as 78-014.

* Cost optimized version. Parts are bifurcated every 3 or 4 fingers.

Series Dimensions

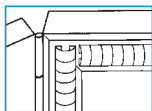
Series	A	B	C	D	E	H	M Radius	Approx. Length
*77-012	0.320 (8,128)	0.110 (2,794)	0.002 (0,051)	0.187 (4,750)	0.018 (0,457)	0.210 (5,334)	0.110 (2,794)	24,000 (609,600)
*77-014	0.600 (15,240)	0.220 (5,588)	0.004 (0,102)	0.375 (9,525)	0.032 (0,813)	0.280 (7,112)	0.180 (4,572)	24,000 (609,600)
*77-033	0.370 (9,398)	0.130 (3,302)	0.002 (0,051)	0.250 (6,350)	0.025 (0,635)	0.210 (5,334)	0.110 (2,794)	16,000 (406,400)
77-073	0.320 (8,128)	0.110 (2,794)	0.002 (0,051)	0.187 (4,750)	0.018 (0,457)	0.210 (5,334)	0.110 (2,794)	24,000 (609,600)
77-074	0.600 (15,240)	0.220 (5,588)	0.0035 (0,089)	0.375 (9,525)	0.032 (0,813)	0.280 (7,112)	0.180 (4,572)	24,000 (609,600)
77-078	0.800 (20,320)	0.320 (8,128)	0.004 (0,102)	0.375 (9,525)	0.032 (0,813)	0.440 (11,176)	0.190 (4,826)	24,000 (609,600)
77-079	0.320 (8,128)	0.100 (2,540)	0.004 (0,102)	0.156 (3,962)	0.018 (0,457)	0.210 (5,334)	0.100 (2,540)	16,000 (406,400)
77-080	0.320 (8,128)	0.100 (2,540)	0.0035 (0,089)	0.187 (4,750)	0.018 (0,457)	0.210 (5,334)	0.100 (2,540)	18,000 (457,200)
*77-081	0.280 (7,112)	0.110 (2,794)	0.002 (0,051)	0.187 (4,750)	0.018 (0,457)	0.180 (4,572)	0.100 (2,540)	24,000 (609,600)
77-082	1.100 (27,940)	0.400 (10,160)	0.005 (0,127)	0.500 (12,700)	0.040 (1,016)	0.780 (19,812)	0.420 (10,668)	18,000 (457,200)
77-083	0.370 (9,398)	0.130 (3,302)	0.004 (0,102)	0.125 (3,175)	0.025 (0,635)	0.100 (2,540)	0.202 (5,131)	16,000 (406,400)
77-084	0.370 (9,398)	0.130 (3,302)	0.004 (0,102)	0.250 (6,350)	0.025 (0,635)	0.100 (2,540)	0.202 (5,131)	16,000 (406,400)
77-085	0.600 (15,240)	0.220 (5,588)	0.004 (0,102)	0.375 (9,525)	0.032 (0,813)	0.150 (3,810)	0.295 (7,493)	18,000 (457,200)
77-092	0.600 (15,240)	0.221 (5,613)	0.0035 (0,089)	0.187 (4,750)	0.032 (0,812)	0.295 (7,493)	X X	18,000 (457,200)



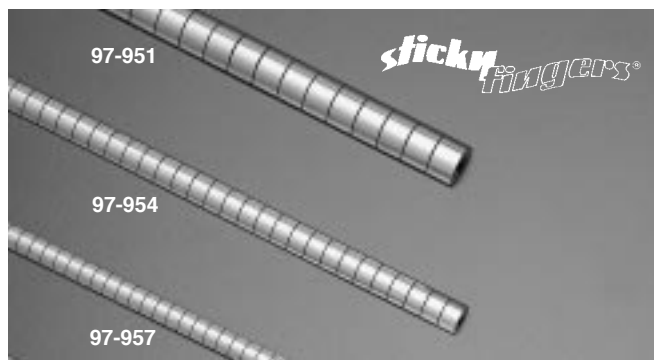
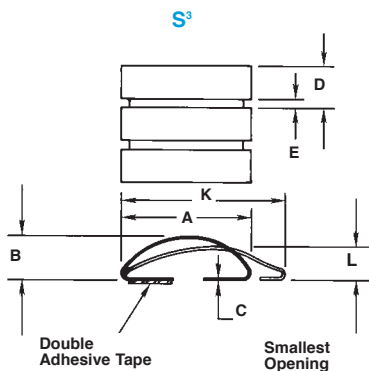
All dimensions shown are in inches (millimeters) unless otherwise specified.
For availability see pages 6-11.



Sticky Fingers® Pressure Sensitive Tape (PSA) Mount Symmetrical Slotted Shielding (S³)



- A wide radius profile creates the greatest contact for maximum conductivity
- Available in both Sticky Fingers® and rivet mount

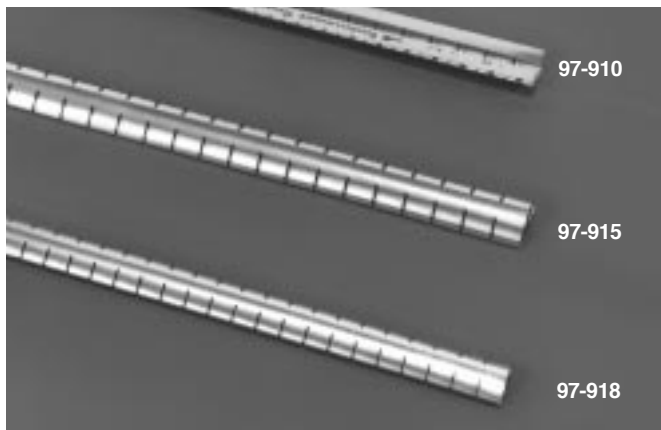


S³ Series — Sticky Fingers®

Series	A Min.	B	C	D	E	K	L	Approx. Length
97-951	0.620 (15,748)	0.220 (5,588)	0.004 (0,102)	0.375 (9,525)	0.030 (0,762)	0.760 (19,304)	0.100 (2,540)	15,000 (381,000)
97-954	0.450 (11,430)	0.140 (3,556)	0.003 (0,076)	0.250 (6,350)	0.022 (0,559)	0.510 (12,954)	0.070 (1,778)	15,000 (381,000)
97-957	0.350 (8,890)	0.110 (2,794)	0.003 (0,076)	0.187 (4,750)	0.018 (0,457)	0.380 (9,652)	0.055 (1,397)	15,000 (381,000)



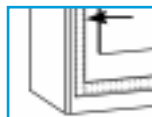
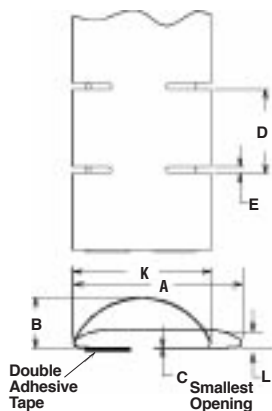
Sticky Fingers® Pressure Sensitive Tape (PSA) Mount Solid Top (S³) Symmetrical Slotted Shielding Gasket



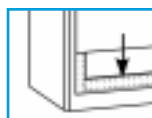
- The solid top design allows the engaging panel or door to slide either perpendicularly or parallel to the fingerstock
- Shorter slot provides improved shielding effectiveness (100 dB)
- Offered in both rivet mount and tape mount versions

Solid Top S³ Series — Sticky Fingers®

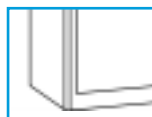
Series	A Min.	B	C	D	E	K	L	Approx. Length
97-910	0.620 (15,748)	0.220 (5,588)	0.004 (0,102)	0.375 (9,525)	0.030 (0,762)	0.760 (19,304)	0.100 (2,540)	15,000 (381,000)
97-915	0.450 (11,430)	0.140 (3,556)	0.003 (0,076)	0.250 (6,350)	0.022 (0,559)	0.510 (12,954)	0.070 (1,778)	15,000 (381,000)
97-918	0.350 (8,890)	0.110 (2,794)	0.003 (0,076)	0.187 (4,750)	0.018 (0,457)	0.380 (9,652)	0.070 (1,778)	15,000 (381,000)



View A — A computer tower side panel is moved sideways during the first step of installation.



View B — Next, the panel is moved downwards, sliding longitudinally on the vertical finger gasket.

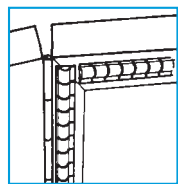
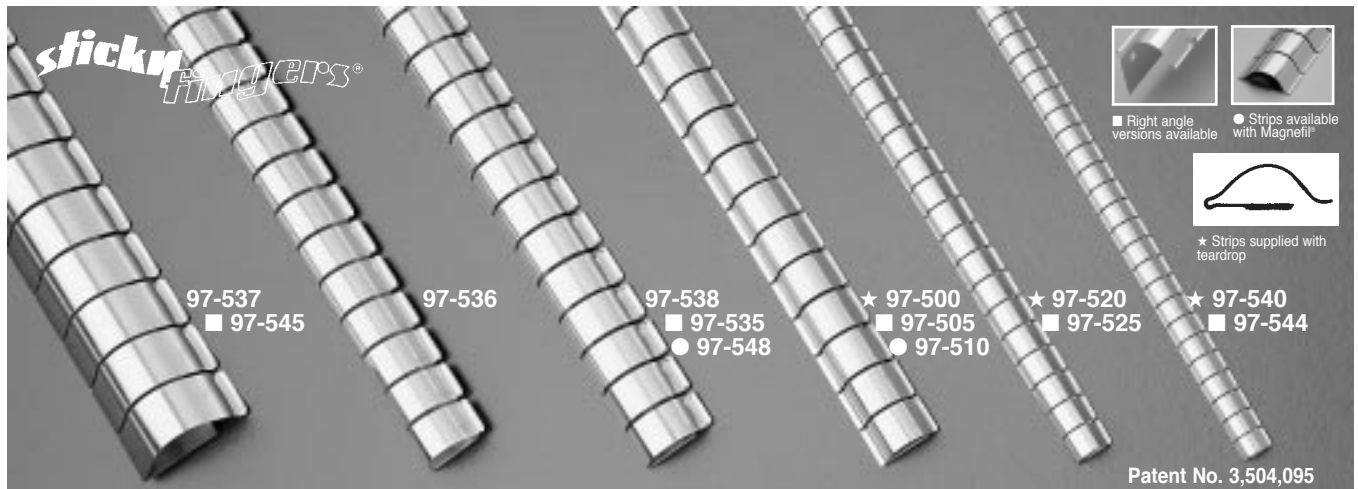


View C — Fully installed panel is now compressing both finger gaskets.

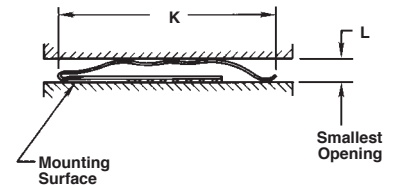
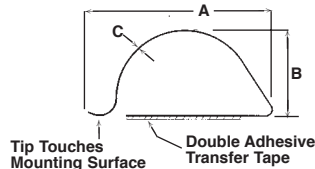
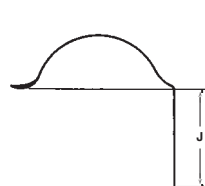
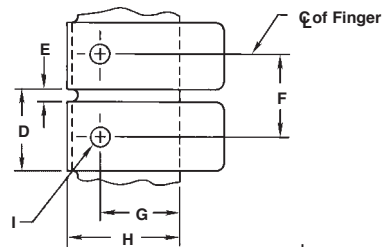
All dimensions shown are in inches (millimeters) unless otherwise specified.
For availability see pages 6–11.



Sticky Fingers® Pressure Sensitive Tape (PSA) Mount All Purpose Gasket



- Available in strips and coil form
- Designated strips are available with Magnefil®, a rubber strip filled with magnetic absorbing particles, which provides increased magnetic field shielding



All Purpose Series

Series	A	B Min.	C	D	E	F	G	H	I	J	K	L	Approx. Length in. (mm)	Approx. Coil ft. (m)
97-500	0.600 (15,240)	0.230 (5,842)	0.004 (0,102)	0.375 (9,525)	0.032 (0,813)	0.380 (9,652)	0.310 (7,874)	0.500 (12,700)	0.080 (2,032)	N/A	0.770 (19,558)	0.040 (1,016)	24.000 (609,600)	25.000 (7,6)
97-505	0.600 (15,240)	0.230 (5,842)	0.004 (0,102)	0.375 (9,525)	0.032 (0,813)	0.380 (9,652)	0.310 (7,874)	N/A	0.080 (2,032)	0.500 (12,700)	0.770 (19,558)	0.040 (1,016)	24.000 (609,600)	25.000 (7,6)
97-510	0.600 (15,240)	0.230 (5,842)	0.004 (0,102)	0.375 (9,525)	0.032 (0,813)	0.380 (9,652)	0.310 (7,874)	0.500 (12,700)	0.080 (2,032)	N/A	0.770 (19,558)	0.040 (1,016)	24.000 (609,600)	25.000 (7,6)
97-520	0.370 (9,398)	0.140 (3,556)	0.003 (0,076)	0.250 (6,350)	0.022 (0,559)	0.250 (6,350)	0.090 (2,286)	0.310 (7,874)	0.060 (1,524)	N/A	0.500 (12,700)	0.070 (1,778)	16.000 (406,400)	25.000 (7,6)
97-525	0.370 (9,398)	0.140 (3,556)	0.003 (0,076)	0.250 (6,350)	0.022 (0,559)	0.250 (6,350)	0.090 (2,286)	N/A	0.060 (1,524)	0.320 (8,128)	0.500 (12,700)	0.070 (1,778)	16.000 (406,400)	25.000 (7,6)
97-535	0.780 (19,812)	0.250 (6,350)	0.005 (0,127)	0.375 (9,525)	0.040 (1,016)	0.380 (9,652)	0.380 (9,652)	N/A	0.140 (3,556)	0.480 (12,192)	0.940 (23,876)	0.080 (2,032)	12.000 (304,800)	25.000 (7,6)
97-536	0.670 (17,018)	0.310 (7,874)	0.004 (0,102)	0.375 (9,525)	0.040 (1,016)	0.380 (9,652)	0.380 (9,652)	0.530 (13,462)	0.140 (3,556)	N/A	0.940 (23,876)	0.140 (3,556)	24.000 (609,600)	25.000 (7,6)
97-537	1.130 (28,702)	0.410 (10,414)	0.007 (0,178)	0.500 (12,700)	0.040 (1,016)	0.500 (12,700)	0.560 (14,224)	0.780 (19,812)	0.140 (3,556)	N/A	1.940 (49,276)	0.100 (2,540)	12.000 (304,800)	N/A
97-538	0.780 (19,812)	0.250 (6,350)	0.005 (0,127)	0.375 (9,525)	0.040 (1,016)	0.380 (9,652)	0.380 (9,652)	0.530 (13,462)	0.140 (3,556)	N/A	0.940 (23,876)	0.080 (2,032)	24.000 (609,600)	25.000 (7,6)
97-540	0.280 (7,112)	0.110 (2,794)	0.003 (0,076)	0.188 (4,775)	0.018 (0,457)	0.190 (4,826)	0.080 (2,032)	0.230 (5,842)	0.060 (1,524)	N/A	0.370 (9,398)	0.065 (1,651)	16.000 (406,400)	25.000 (7,6)
97-544	0.260 (6,604)	0.110 (2,794)	0.003 (0,076)	0.188 (4,775)	0.018 (0,457)	0.190 (4,826)	0.080 (2,032)	N/A	0.060 (1,524)	0.240 (6,096)	0.370 (9,398)	0.065 (1,651)	16.000 (406,400)	25.000 (7,6)
97-545	1.130 (28,702)	0.410 (10,414)	0.007 (0,178)	0.500 (12,700)	0.040 (1,016)	0.500 (12,700)	0.560 (14,224)	N/A	0.140 (3,556)	0.750 (19,050)	1.940 (49,276)	0.100 (2,540)	12.000 (304,800)	N/A
97-548	0.780 (19,812)	0.250 (6,350)	0.005 (0,127)	0.375 (9,525)	0.040 (1,016)	0.380 (9,652)	0.380 (9,652)	0.530 (13,462)	0.140 (3,556)	N/A	0.940 (23,876)	0.080 (2,032)	24.000 (609,600)	25.000 (7,6)

All dimensions shown are in inches (millimeters) unless otherwise specified.
For availability see pages 6-11.



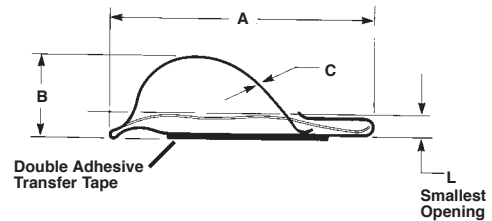
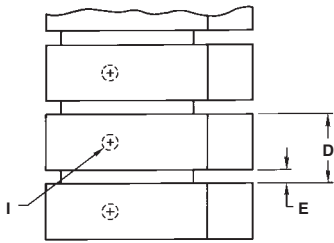
Sticky Fingers® Pressure Sensitive Tape (PSA) Mount Foldover Series



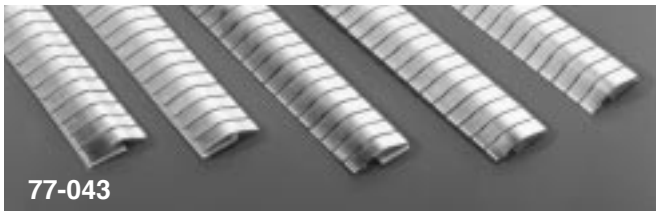
- Folded over end captures sliding finger to prevent snagging of fingers
- Available in strip and 25 ft. (7,6 m) coils

Foldover Series

Series	A	B	C Pitch	D Slot	E Dia.	I	L	Approx. Length in. (mm)	Approx. Coil ft. (m)
97-515	0.760 (19,304)	0.230 (5,842)	0.004 (0,102)	0.375 (9,525)	0.032 (0,813)	0.080 (2,032)	0.060 (1,524)	24,000 (609,600)	25,000 (7,6)
97-521	0.510 (12,954)	0.140 (3,556)	0.003 (0,076)	0.250 (6,350)	0.022 (0,559)	0.060 (1,524)	0.070 (1,778)	16,000 (406,400)	25,000 (7,6)
97-541	0.380 (9,652)	0.120 (3,048)	0.003 (0,076)	0.188 (4,775)	0.018 (0,457)	0.060 (1,524)	0.050 (1,270)	16,000 (406,400)	25,000 (7,6)
97-542	0.250 (6,350)	0.080 (2,032)	0.003 (0,076)	0.188 (4,775)	0.018 (0,457)	0.060 (1,524)	0.050 (1,270)	16,000 (406,400)	25,000 (7,6)

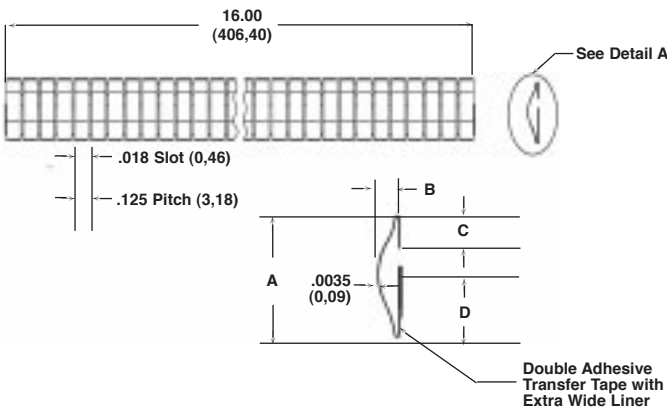


Sticky Fingers® Pressure Sensitive Tape (PSA) Mount Low Profile Gasket



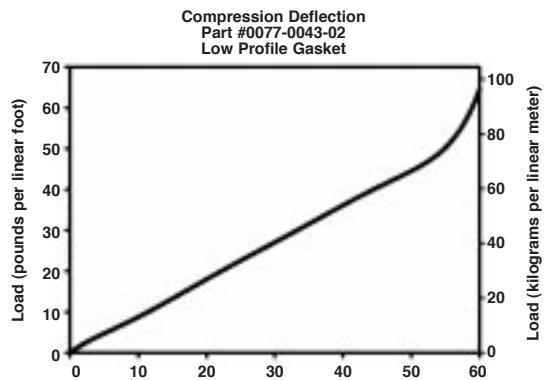
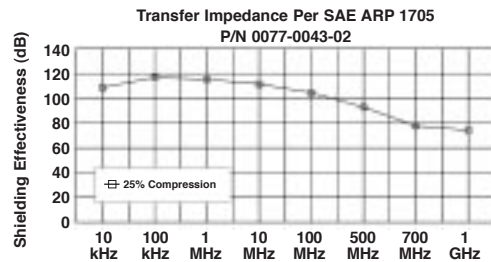
- Ideally suited for limited space applications as low as 0.060 in. (1,524 mm)
- Sticky Fingers® PSA tape available with extra wide release liner to facilitate application

77-043/77-049



Low Profile Series

Series	A	B	C	D
77-043	0.450 (11,430)	0.080 (2,032)	0.121 (3,073)	0.262 (6,665)
77-049	0.600 (15,240)	0.120 (3,048)	0.162 (4,115)	0.347 (8,814)

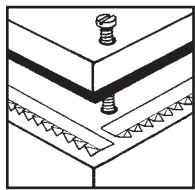
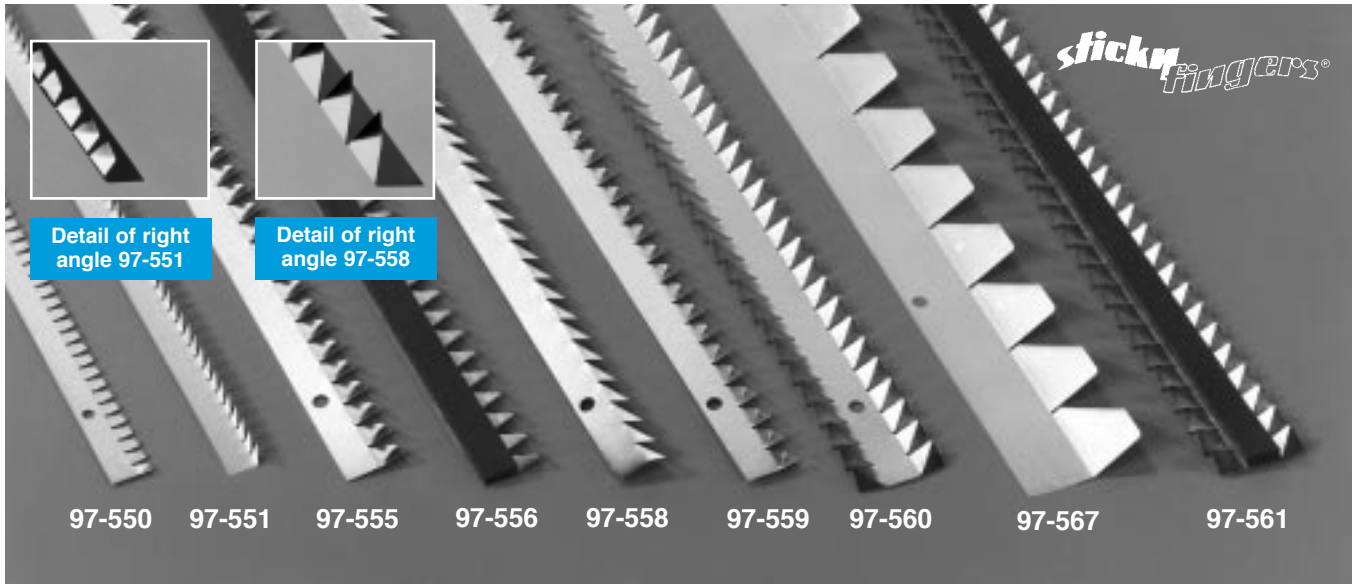


All dimensions shown are in inches (millimeters) unless otherwise specified.
For availability see pages 6-11.



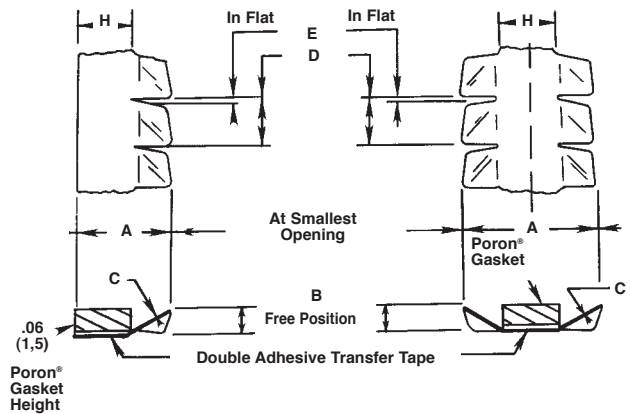


Sticky Fingers® Pressure Sensitive Tape (PSA) Mount Twist Series



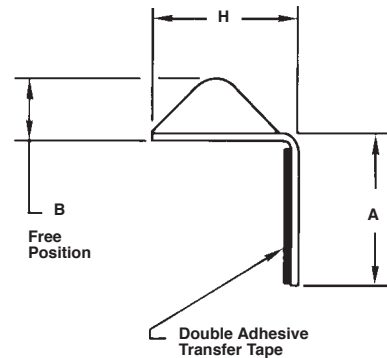
- Low finger heights make these gaskets ideal for limited space applications
- Available in 24 in. (610 mm) strips and 25 ft. (7,6 m) coils, except two 90° versions

- Poron® rubber gaskets can be incorporated into two versions for protection from dust and moisture



Twist Series

Series	A	B	C	D Pitch	E Slot	H	Approx. Length in. (mm)	Approx. Coil ft. (m)	Gasket
97-547	0.140 (3,556)	0.030 (0,760)	0.003 (0,076)	0.095 (2,413)	0.015 (0,381)	0.090 (2,286)	24.000 (609,600)	—	NO
97-550	0.230 (5,842)	0.030 (0,762)	0.003 (0,076)	0.095 (2,413)	0.015 (0,381)	0.140 (3,556)	24.000 (609,600)	25.000 (7,6)	NO
97-551	0.160 (4,064)	0.030 (0,762)	0.003 (0,076)	0.095 (2,413)	0.015 (0,381)	0.080 (2,032)	24.000 (609,600)	—	NO
97-555	0.340 (8,636)	0.070 (1,778)	0.003 (0,076)	0.165 (4,191)	0.015 (0,381)	0.180 (4,572)	24.000 (609,600)	25.000 (7,6)	NO
97-556	0.340 (8,636)	0.070 (1,778)	0.003 (0,076)	0.165 (4,191)	0.015 (0,381)	0.180 (4,572)	24.000 (609,600)	25.000 (7,6)	YES
97-558	0.200 (5,080)	0.070 (1,778)	0.003 (0,076)	0.165 (4,191)	0.015 (0,381)	0.110 (2,794)	24.000 (609,600)	—	NO
97-559	0.300 (7,620)	0.070 (1,778)	0.003 (0,076)	0.165 (4,191)	0.015 (0,381)	0.180 (4,572)	24.000 (609,600)	25.000 (7,6)	NO
97-560	0.500 (12,700)	0.070 (1,778)	0.003 (0,076)	0.165 (4,191)	0.015 (0,381)	0.190 (4,826)	24.000 (609,600)	25.000 (7,6)	NO
97-561	0.500 (12,700)	0.070 (1,778)	0.003 (0,076)	0.165 (4,191)	0.015 (0,381)	0.190 (4,826)	24.000 (609,600)	25.000 (7,6)	YES
97-567	0.725 (18,415)	0.209 (5,309)	0.003 (0,076)	0.500 (12,700)	0.015 (0,381)	0.408 (10,363)	24.000 (609,600)	25.000 (7,6)	NO
97-569	0.500 (12,70)	0.120 (3,048)	0.003 (0,076)	0.250 (6,350)	0.015 (0,381)	0.250 (6,350)	24.000 (609,600)	25.000 (7,6)	NO



97-551/97-558/97-547

All dimensions shown are in inches (millimeters) unless otherwise specified.
For availability see pages 6-11.

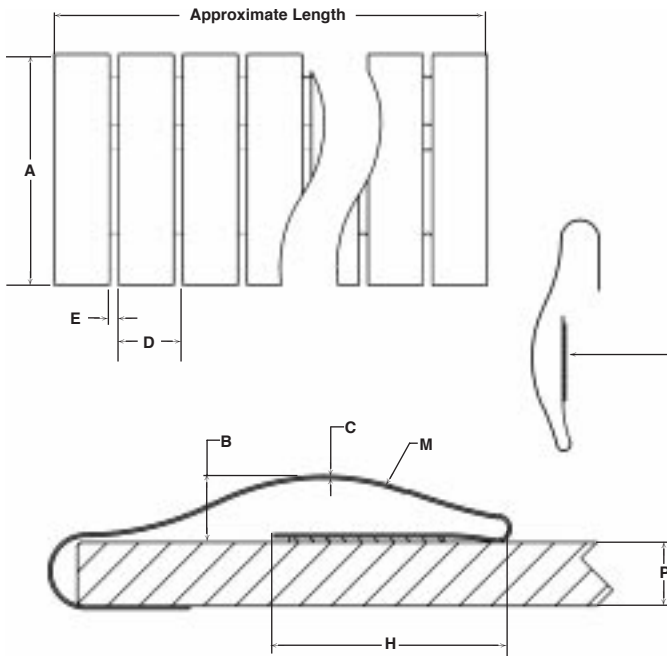
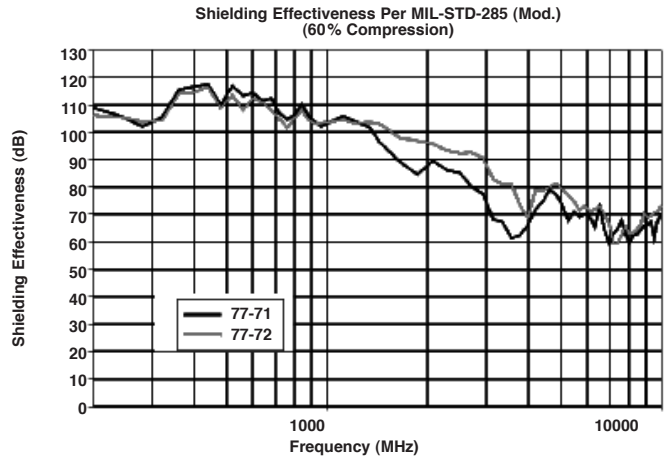


Sticky Fingers® Pressure Sensitive Tape (PSA) Mount Low Profile Hook-On



- Dual attachment includes PSA tape and hook-on of one end onto the edge of housing
- Ideally suited for limited space applications as low as 0.060 in. (1,524 mm)

Figure 1



Profile View
Scale 10:1

Dimensions

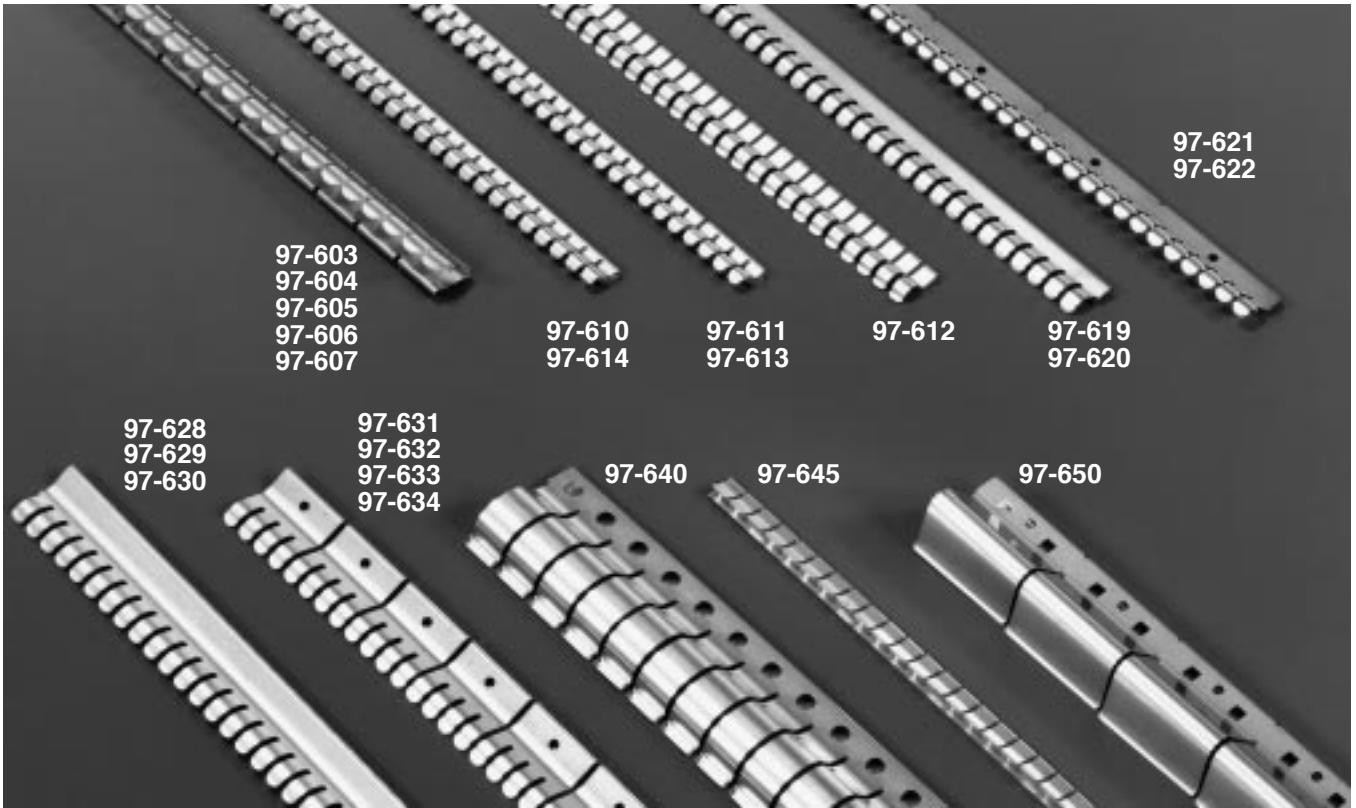
Series	A	B	C	D	E	H	M	P	Approx. Length	No. of Fingers
77-071	0.450 (11,430)	0.060 (1,524)	0.004 (0,102)	0.125 (3,175)	0.018 (0,457)	0.267 (6,782)	0.200 (5,080)	0.062 (1,575)	16.2 (411,5)	130
77-072	0.600 (15,240)	0.090 (2,286)	0.004 (0,102)	0.125 (3,175)	0.018 (0,457)	0.329 (8,357)	0.200 (5,080)	0.062 (1,575)	16.2 (411,5)	130



All dimensions shown are in inches (millimeters) unless otherwise specified.
For availability see pages 6-11.

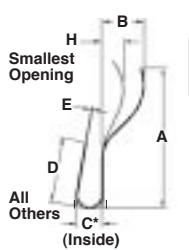
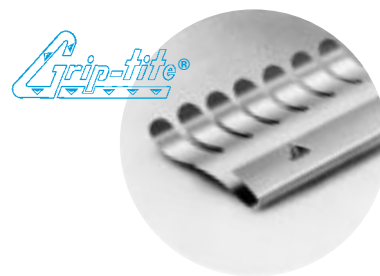
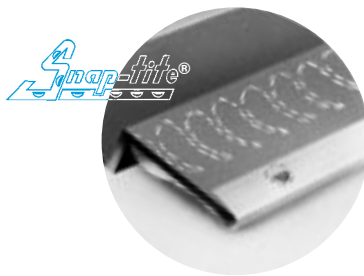


Clip-On Mounting Clip-On Gasket

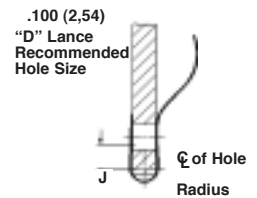
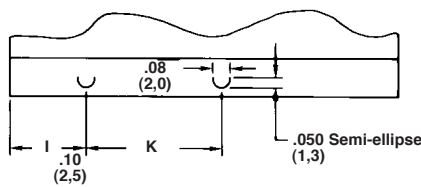


- Designed for use where high temperature or other design considerations preclude the use of adhesive-mounted gasketing
- "D" lance version snaps into 0.10 in. (2,5 mm) diameter holes to create strong omnidirectional grip

- Sharp "T" lance version bites into softer materials, such as aluminum and plated plastics, to ensure retention and preserve electrical conductivity



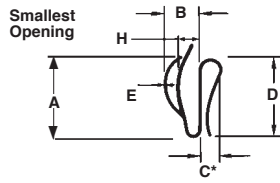
"D" Lance Detail



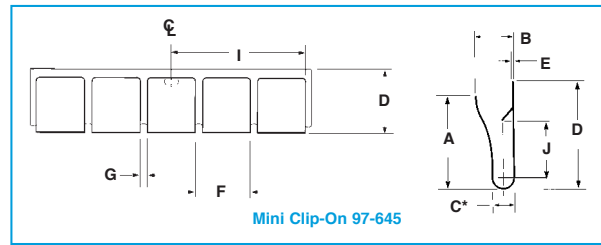
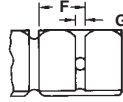
All dimensions shown are in inches (millimeters) unless otherwise specified.
For availability see pages 6-11.



Clip-On Mounting Clip-On Gasket



Clip-On Series
97-603/604/605/606/607



*Variations in the clip-on area are available. Consult sales department.

Clip-On Series

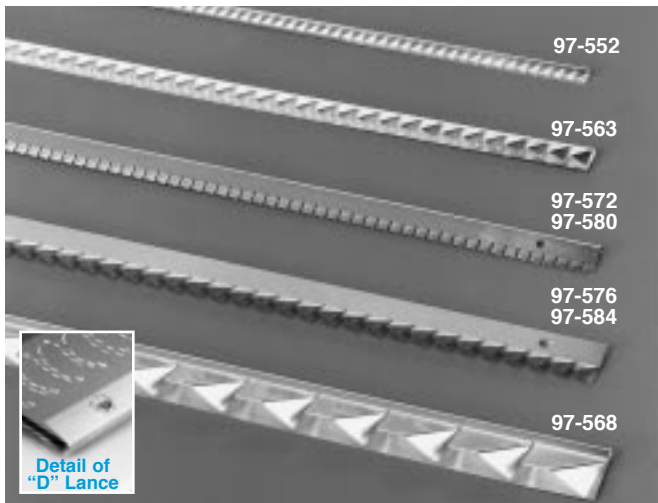
Series										No Lance	Square Lance	Grip-lite® "T" Lance	Snap-lite® "D" Lance	Lance Locations Dimensions		Lance to Lance Dims.	Body Style	
	A	B	C	D	E	F	G	H	Approx. Length	NL	SQ	GT	ST	I	J	K	Slot	Sol.
97-603	0.380 (9.652)	0.200 (5.080)	0.100 (2.540)	0.330 (8.382)	0.005 (0.127)	0.250 (6.350)	0.040 (1.016)	0.060 (1.524)	16.000 (406.400)	—	—	—	X	0.250 (6.350)	0.099 (2.515)	0.500 (12.700)	X	—
97-604	0.330 (8.382)	0.280 (7.112)	0.070 (1.778)	0.380 (9.652)	0.005 (0.127)	0.250 (6.350)	0.040 (1.016)	0.100 (2.540)	16.000 (406.400)	—	—	X	—	0.230 (5.842)	0.204 (5.182)	0.500 (12.700)	X	—
97-605	0.380 (9.652)	0.200 (5.080)	0.070 (1.778)	0.380 (9.652)	0.005 (0.127)	0.250 (6.350)	0.040 (1.016)	0.060 (1.524)	16.000 (406.400)	—	—	X	—	0.230 (5.842)	0.204 (5.182)	0.500 (12.700)	X	—
97-606	0.380 (9.652)	0.200 (5.080)	0.070 (1.778)	0.380 (9.652)	0.005 (0.127)	0.250 (6.350)	0.040 (1.016)	0.060 (1.524)	16.000 (406.400)	—	—	—	X	0.250 (6.350)	0.161 (4.089)	0.500 (12.700)	X	—
97-607	0.330 (8.382)	0.280 (7.112)	0.070 (1.778)	0.380 (9.652)	0.005 (0.127)	0.250 (6.350)	0.040 (1.016)	0.100 (2.540)	16.000 (406.400)	—	—	—	X	0.250 (6.350)	0.161 (4.089)	0.500 (12.700)	X	—
97-610	0.300 (7.620)	0.100 (2.540)	0.070 (1.778)	0.190 (4.826)	0.005 (0.127)	0.187 (4.750)	0.047 (1.194)	0.065 (1.651)	16.000 (406.400)	X	—	#	#	—	—	—	—	X
97-611	0.300 (7.620)	0.100 (2.540)	0.070 (1.778)	0.190 (4.826)	0.005 (0.127)	0.182 (4.623)	0.047 (1.194)	0.060 (1.524)	16.000 (406.400)	—	—	X	—	0.364 (9.246)	0.062 (1.575)	0.728 (18.491)	X	—
97-612	0.440 (11.176)	0.100 (2.540)	0.070 (1.778)	0.190 (4.826)	0.003 (0.076)	0.187 (4.750)	0.047 (1.194)	0.045 (1.143)	16.000 (406.400)	#	X	—	—	0.093 (2.362)	0.050 (1.270)	0.750 (19.050)	X	—
97-613	0.300 (7.620)	0.100 (2.540)	0.070 (1.778)	0.190 (4.826)	0.005 (0.127)	0.182 (4.623)	0.047 (1.194)	0.060 (1.524)	16.000 (406.400)	—	—	—	X	0.364 (9.246)	0.054 (1.372)	0.728 (18.491)	X	—
97-614	0.300 (7.620)	0.100 (2.540)	0.050 (1.270)	0.190 (4.826)	0.005 (0.127)	0.187 (4.750)	0.047 (1.194)	0.065 (1.651)	16.000 (406.400)	X	—	#	#	—	—	—	—	X
97-619	0.440 (11.176)	0.080 (2.032)	0.050 (1.270)	0.190 (4.826)	0.005 (0.127)	0.187 (4.750)	0.047 (1.194)	0.045 (1.143)	16.000 (406.400)	X	—	#	#	—	—	—	—	X
97-620	0.440 (11.176)	0.080 (2.032)	0.070 (1.778)	0.190 (4.826)	0.005 (0.127)	0.187 (4.750)	0.047 (1.194)	0.045 (1.143)	16.000 (406.400)	X	—	#	#	—	—	—	—	X
97-621	0.440 (11.176)	0.120 (3.048)	0.070 (1.778)	0.230 (5.842)	0.005 (0.127)	0.193 (4.902)	0.046 (1.168)	0.070 (1.778)	16.000 (406.400)	—	—	X	—	0.652 (16.561)	0.084 (2.134)	1.351 (34.315)	X	—
97-622	0.440 (11.176)	0.120 (3.048)	0.070 (1.778)	0.190 (4.826)	0.005 (0.127)	0.193 (4.902)	0.046 (1.168)	0.075 (1.905)	16.000 (406.400)	—	—	—	X	0.290 (7.366)	0.060 (1.524)	0.725 (18.415)	X	—
97-628	0.600 (15.240)	0.210 (5.334)	0.100 (2.540)	0.230 (5.842)	0.005 (0.127)	0.187 (4.750)	0.047 (1.194)	0.070 (1.778)	16.000 (406.400)	X	—	#	#	—	—	—	—	X
97-629	0.600 (15.240)	0.210 (5.334)	0.050 (1.270)	0.190 (4.826)	0.005 (0.127)	0.187 (4.750)	0.047 (1.194)	0.070 (1.778)	16.000 (406.400)	X	—	#	#	—	—	—	—	X
97-630	0.600 (15.240)	0.210 (5.334)	0.070 (1.778)	0.190 (4.826)	0.005 (0.127)	0.187 (4.750)	0.047 (1.194)	0.070 (1.778)	16.000 (406.400)	X	—	#	#	—	—	—	—	X
97-631	0.600 (15.240)	0.210 (5.334)	0.070 (1.778)	0.190 (4.826)	0.005 (0.127)	0.182 (4.623)	0.047 (1.194)	0.080 (2.032)	16.000 (406.400)	—	—	X	—	0.364 (9.246)	0.058 (1.473)	0.728 (18.491)	X	—
97-632	0.600 (15.240)	0.210 (5.334)	0.070 (1.778)	0.190 (4.826)	0.005 (0.127)	0.182 (4.623)	0.047 (1.194)	0.080 (2.032)	16.000 (406.400)	—	—	—	X	0.364 (9.246)	0.058 (1.473)	0.728 (18.491)	X	—
97-633	0.600 (15.240)	0.210 (5.334)	0.050 (1.270)	0.190 (4.826)	0.005 (0.127)	0.182 (4.623)	0.047 (1.194)	0.080 (2.032)	16.000 (406.400)	—	—	X	—	0.364 (9.246)	0.058 (1.473)	0.728 (18.491)	X	—
97-634	0.600 (15.240)	0.210 (5.334)	0.050 (1.270)	0.190 (4.826)	0.005 (0.127)	0.182 (4.623)	0.047 (1.194)	0.080 (2.032)	16.000 (406.400)	—	—	—	X	0.364 (9.246)	0.058 (1.473)	0.728 (18.491)	X	—
97-640	1.090 (27.686)	0.260 (6.604)	0.070 (1.778)	0.280 (7.112)	0.005 (0.127)	0.375 (9.525)	0.040 (1.016)	0.060 (1.524)	16.000 (406.400)	X	—	#	#	—	—	—	—	X
97-645	0.210 (5.334)	0.070 (1.778)	0.045 (1.143)	0.250 (6.350)	0.003 (0.076)	0.200 (5.080)	0.030 (0.762)	0.010 (0.254)	24.000 (609.600)	—	—	—	X	0.485 (12.319)	0.133 (3.378)	1.000 (25.400)	X	—
97-646	0.275 (6.989)	0.089 (2.280)	0.030 (0.762)	0.280 (7.112)	0.004 (0.101)	0.250 (6.350)	0.030 (0.762)	0.100 (0.254)	16.000 (406.00)	X	—	—	#	—	—	—	—	—
97-650	0.980 (24.892)	0.400 (10.160)	0.200 (5.080)	0.300 (7.620)	0.004 (0.102)	1.000 (25.400)	0.030 (0.762)	0.200 (5.080)	16.000 (406.400)	#	#	—	—	0.192 (4.877)	0.120 (3.048)	0.486 (12.344)	X	—

X Standard # Optional

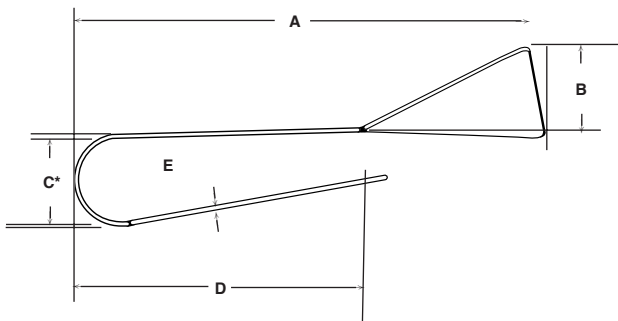
All dimensions shown are in inches (millimeters) unless otherwise specified.
For availability see pages 6-11.



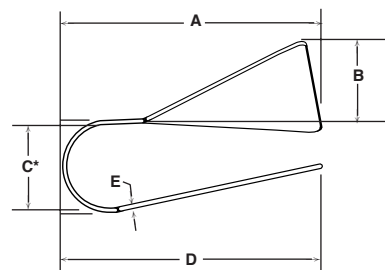
Clip-On Mounting Clip-On Twist Series



- Ideal where mounting space is at a premium due to low finger height
- Available in either equal length leg or offset leg configurations
- Each offset leg configuration is available with Poron® rubber environmental gaskets
- “D” lance snaps into 0.10 in. (2,5 mm) diameter holes to provide added mounted strength
- 97-Series products are also available in UltraSoft® low compression force 98-Series



97-572, 97-580, 97-576, 97-584



97-552, 97-563, 97-568

*Variations in the clip-on area are available. Consult sales department.

Clip-On Twist Series

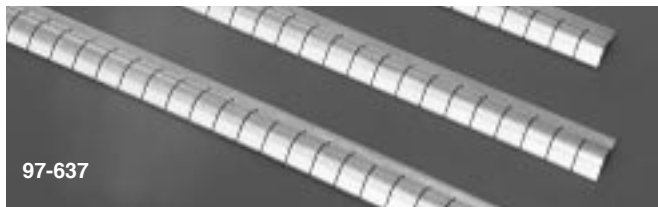
Series	A	B	C	D	E	Pitch	Slot	Approx. Length	Part No.		
									With “D” Lance	With Poron®	With “D” Lance and Poron®
97-552	0.150 (3,810)	0.030 (0,762)	0.070 (1,778)	0.150 (3,810)	0.003 (0,076)	0.095 (2,413)	0.015 (0,381)	16.000 (406,400)	97-553	—	—
97-563	0.210 (5,334)	0.070 (1,778)	0.070 (1,778)	0.210 (5,334)	0.003 (0,076)	0.165 (4,191)	0.015 (0,381)	16.000 (406,400)	97-564	—	—
97-568*	0.414 (10,516)	0.210 (5,334)	0.070 (1,778)	0.414 (10,516)	0.003 (0,076)	0.500 (12,700)	0.015 (0,381)	16.000 (406,400)	—	—	—
97-572	0.275 (6,985)	0.030 (0,762)	0.070 (1,778)	0.175 (4,445)	0.003 (0,076)	0.095 (2,413)	0.015 (0,381)	16.000 (406,400)	97-574	97-573	97-575
97-576	0.378 (9,601)	0.075 (1,905)	0.070 (1,778)	0.250 (6,350)	0.003 (0,076)	0.165 (4,191)	0.015 (0,381)	16.000 (406,400)	97-578	97-577	97-579
97-580	0.275 (6,985)	0.030 (0,762)	0.050 (1,270)	0.175 (4,445)	0.003 (0,076)	0.095 (2,413)	0.015 (0,381)	16.000 (406,400)	97-582	97-581	97-583
97-584	0.378 (9,601)	0.075 (1,905)	0.050 (1,270)	0.250 (6,350)	0.003 (0,076)	0.165 (4,191)	0.015 (0,381)	16.000 (406,400)	97-586	97-585	97-587
97-589	0.230 (5,842)	0.031 (0,787)	0.060 (1,520)	0.160 (4,064)	0.003 (0,762)	0.095 (2,413)	0.015 (0,381)	24.000 (609,000)	—	—	—

*Standard with “D” Lance

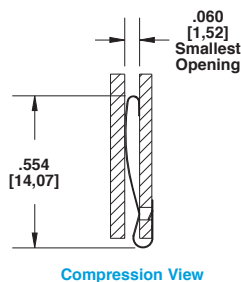
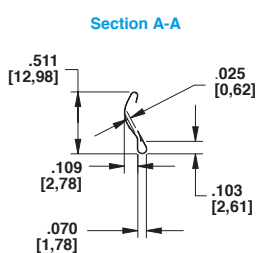
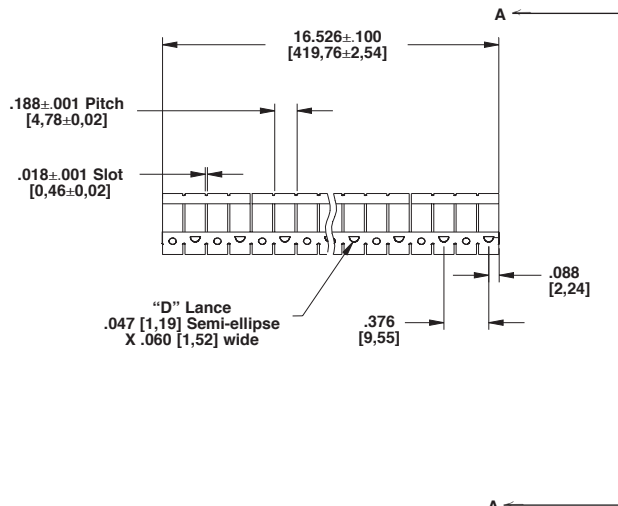
All dimensions shown are in inches (millimeters) unless otherwise specified.
For availability see pages 6–11.



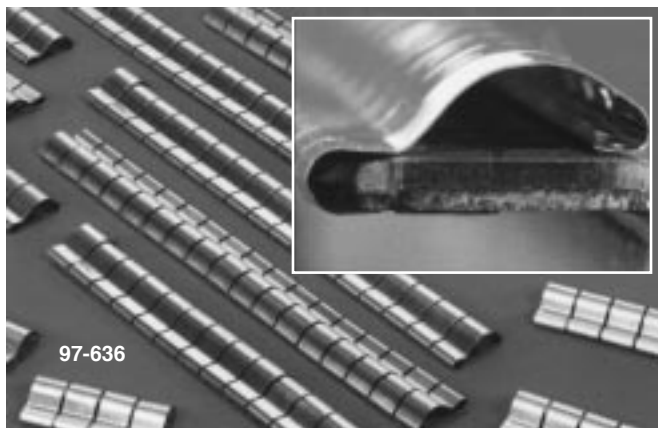
Clip-On Mounting Mini Clip-On Symmetrical Shielding Gasket



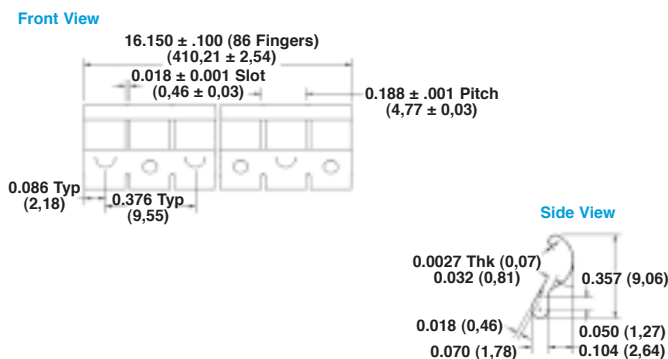
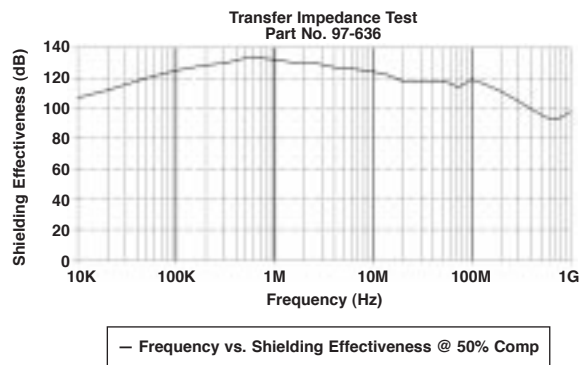
- Designed for card handles, PC board grounding, or any other application requiring clip-on mounting
- Ideal where bi-directional wiping action is required
- Supplied with standard "D" lance ensuring secure holding power by snapping lance into a prefabricated hole



Clip-On Mounting Mini Clip-On Symmetrical Shielding Gasket



- Combines the ease of clip-on mounting with the multi-directional aspects of our symmetrical series
- Functions well in applications requiring sliding movement and direct compression
- Provides maximum contact with minimum compression force, and shielding effectiveness of 120 dB @ 100 MHz

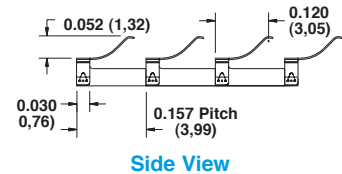
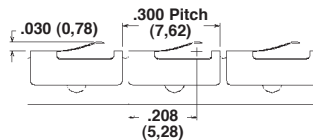
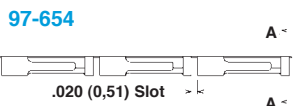
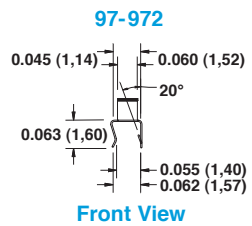
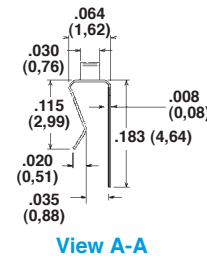
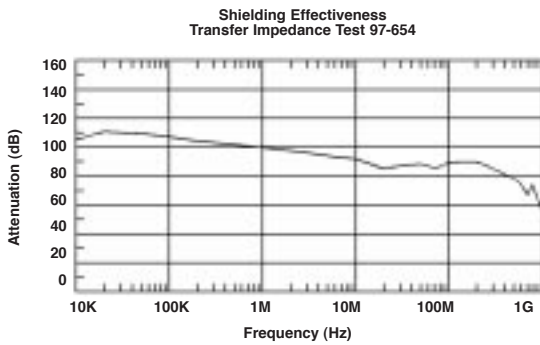


All dimensions shown are in inches (millimeters) unless otherwise specified.
For availability see pages 6-11.



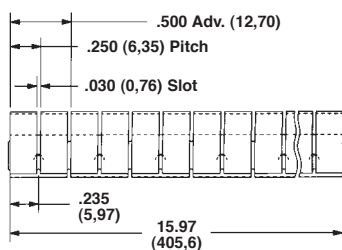
Clip-On Mounting Divider Edge Shield

- Two different size clip-on sections are designed to be applied to the top edge of multicompartmental castings with wall thickness from 0.035 in. (0,88 mm) to 0.060 in. (1,52 mm)
- Clip-on design allows for easy installation and secure retention
- Unique finger design provides extremely low compression force

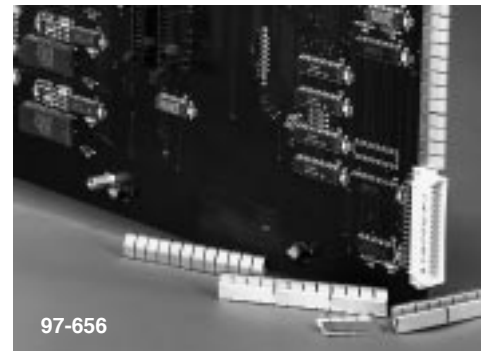
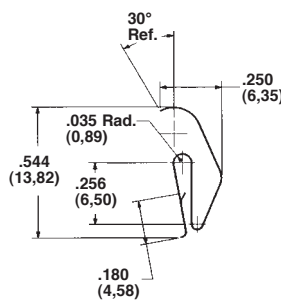


Clip-On Mounting Clip-On Perpendicular Shielding

- Finger design allows for continuous contact across the length of the strip
- "D" lance design provides excellent retention of gasket and allows for a strong omnidirectional grip

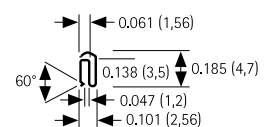
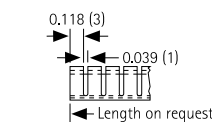


97-656



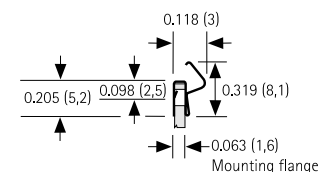
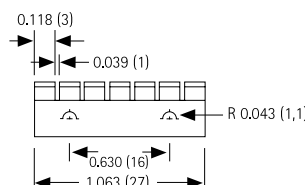
400CO120 Reverse bend contact ELASTIC PERFORMANCE

- Strip with 2.322 in. (59 mm) length, nickel plated
- Compressed from 0.047 to 0.016 in. (1,2 to 0,4 mm), height: 2,2 kp typ.
- Material: Beryllium copper, 0.004 in. (0,09 mm) thick
- Note: available tool is for 2,3,7,11,15 fingers



400CO160 Reverse bend contact

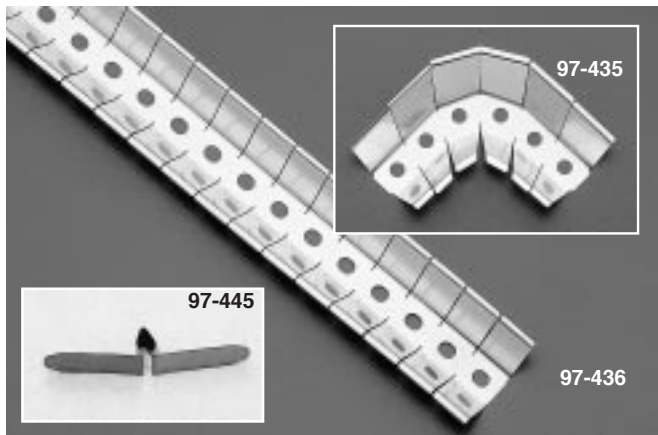
- Consult factory for performance data
- Material: Beryllium copper, 0.002 in. (0,06 mm) thick



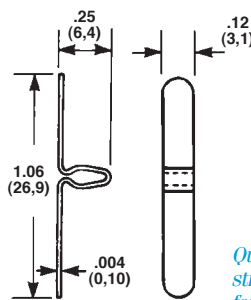
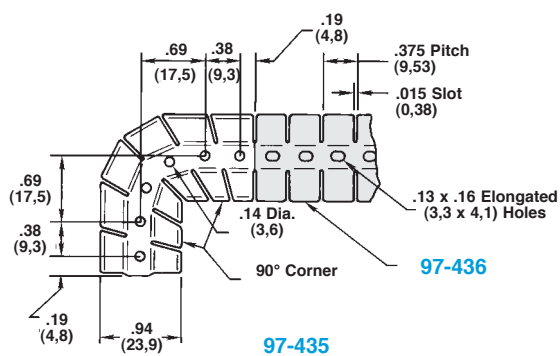
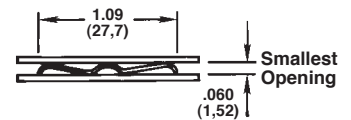
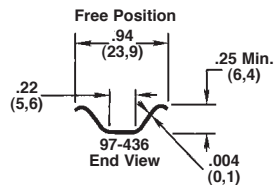
All dimensions shown are in inches (millimeters) unless otherwise specified. For availability see pages 6-11.



Miscellaneous Mounting Double-Sided Contact Strips



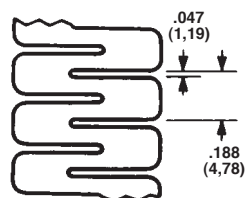
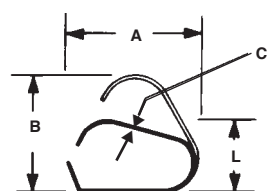
- Mechanically balanced double wing strips provide wide compression range
- Matching 90° corners provide a perfect fit to ensure shielding integrity
- Mechanical mounting methods include rivet and soldering



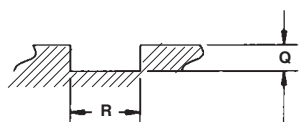
Quick Spring Clip Fastener provides full strip compression; allows lifting of product for cleaning of contact surface



Miscellaneous Mounting Flexible Low Compression Series



Flat Blank



- Low compression, flexible contact strips for applications where gasket must conform to irregular shapes and turn tight radius corners
- Groove mount is easiest mounting method
- Solder or conductive PSA mounting approaches can be used

Flexible Low Compression Series

Series	A	B	C	L	Q	R	Approx. Length
97-921	0.260 (6,604)	0.230 (5,842)	0.003 (0,076)	0.140 (3,556)	0.120 (3,048)	0.250 (6,350)	24,000 (609,600)
97-941	0.200 (5,080)	0.170 (4,318)	0.003 (0,076)	0.110 (2,794)	0.090 (2,286)	0.190 (4,826)	24,000 (609,600)

All dimensions shown are in inches (millimeters) unless otherwise specified.
For availability see pages 6-11.



Metal Grounding Products

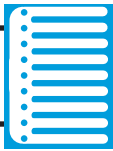


Clip-On Mounting

Clip-On Perpendicular Grounding Strip	33
Clip-On Longitudinal Grounding Strip	33
Card Guide Clip-On	34

Miscellaneous Mounting

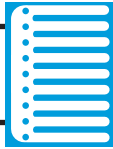
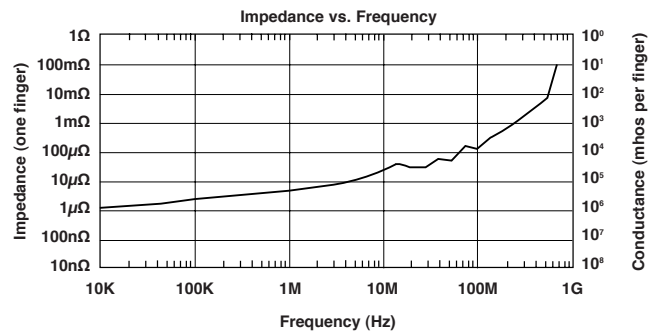
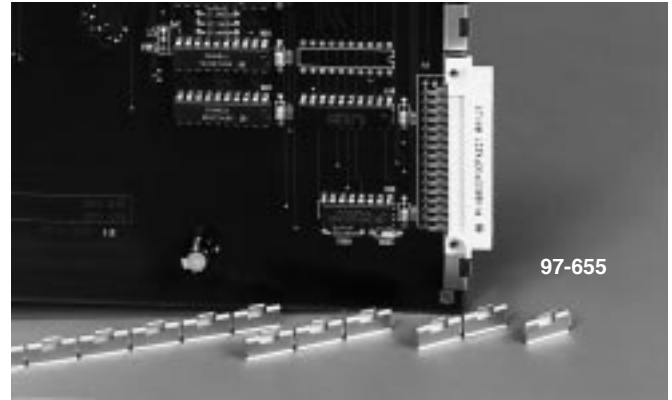
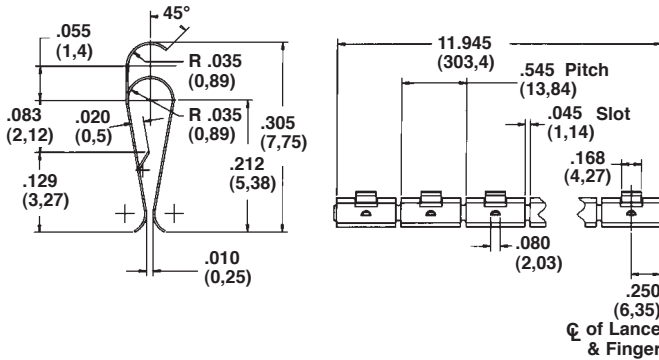
Contact Strips	35
Contact Rings	39
Mini-Longitudinal Grounding Gasket	40
Longitudinal Grounding Series	40
Battery Contacts	41
Custom Stamping	43



Clip-On Mounting Clip-On Perpendicular Grounding Strip

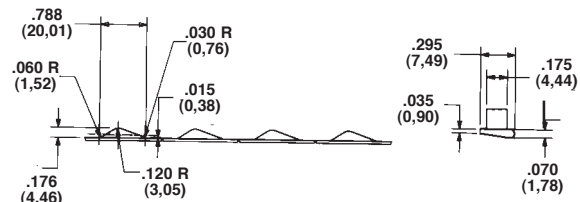
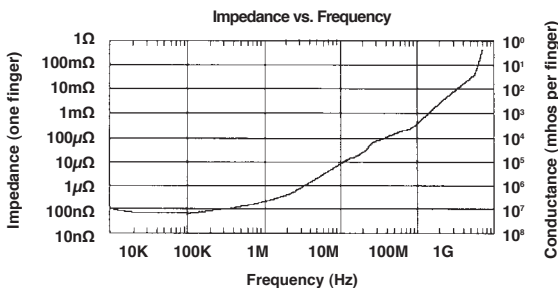
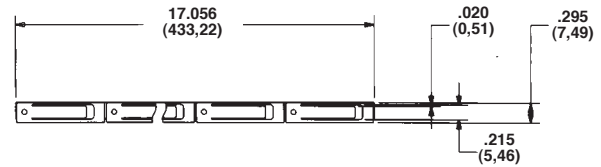
- Clip-on design provides grounding between perpendicular surfaces
- Unique finger extension provides grounding from card or motherboard to a backplane housing
- Wide clip-on area with "D" lance provides secure retention
- Available in strip lengths up to 12 in. (305 mm)

97-655



Clip-On Mounting Clip-On Longitudinal Grounding Strip

- Allows finger compression to slide with the direction of motion in the longitudinal axis
- Ideal for use with rack-mounted, sliding door and slide drawer assemblies
- Finger design provides for bi-directional engagement and eliminates the need for left or right hand versions



All dimensions shown are in inches (millimeters) unless otherwise specified.
For availability see pages 6–11.

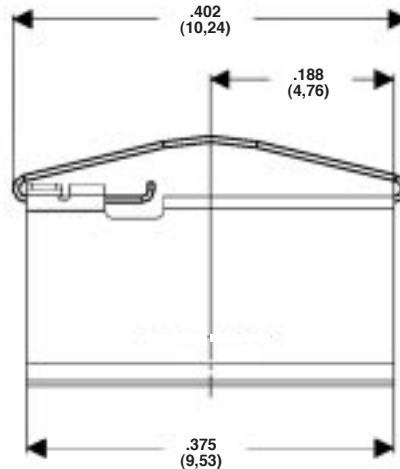
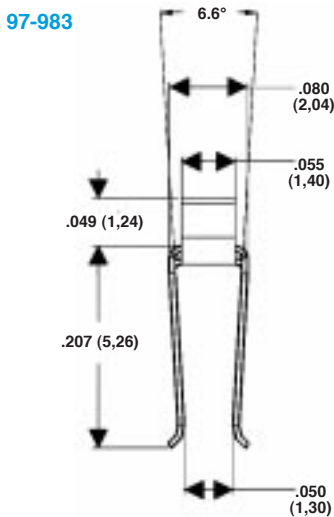
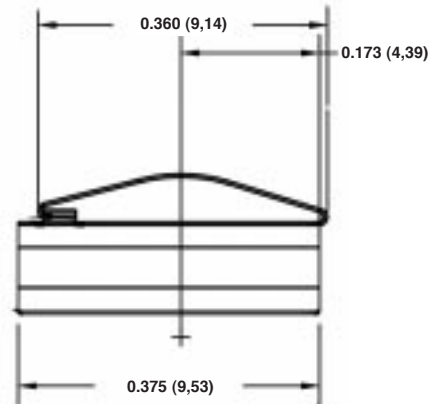
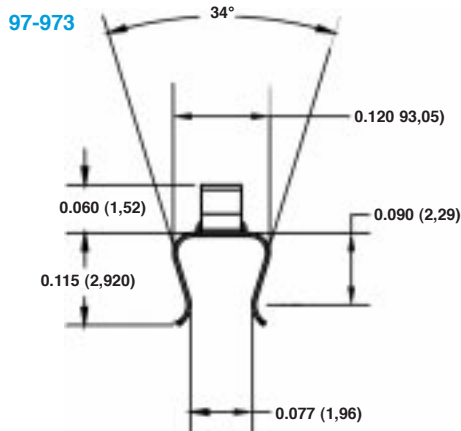
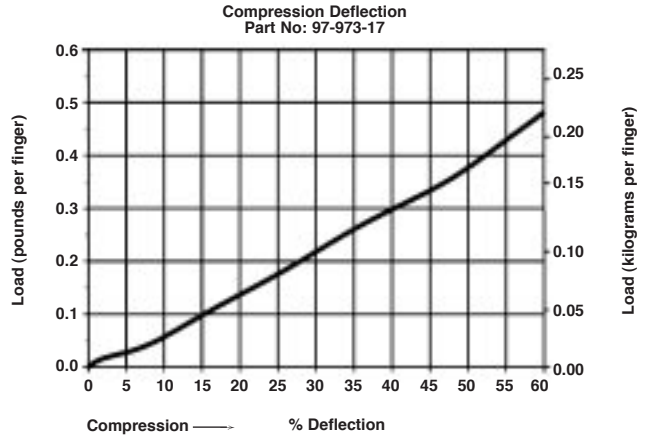




Clip-On Mounting Card Guide Clip-On



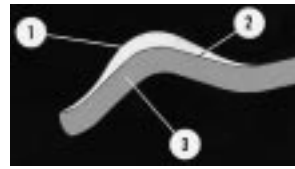
- Grounds printed circuit board to card guides
- Two versions to accommodate board thickness of 0.055 in. (1,40 mm) to 0.100 in. (2,54 mm)
- Available with “D” lance clip-on section for secure attachment needed in bi-directional wiping applications



All dimensions shown are in inches (millimeters) unless otherwise specified.
For availability see pages 6-11.

Miscellaneous Mounting Contact Strips

- Wide variety of finger size, contours, and ring diameters
- Contact rings are formed from contact strips
- Contips® version available, which includes localized deposits of silver or gold to enhance conductivity
- Rings are used for connector shields; single fingers of strips can be used as battery contacts



1. Contips®
2. 100% bond
3. Convex portion of spring

Contips Description	Add Suffix to Catalog Number
Silver Contips only	11
Silver Contips plus silver plating	12
Gold Contips only	13
Gold Contips plus gold plating	14
Gold Contips plus silver plating	20

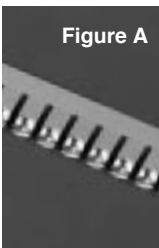
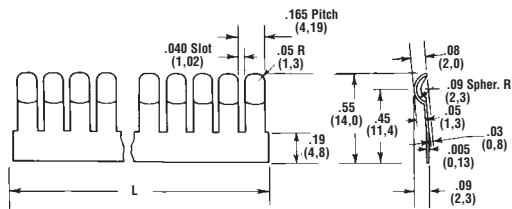
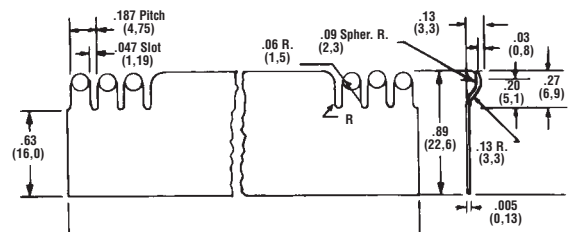


Figure A



97-300

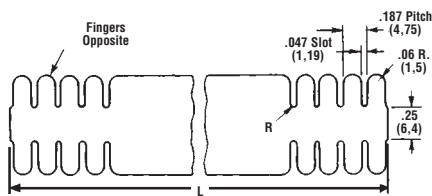


97-117

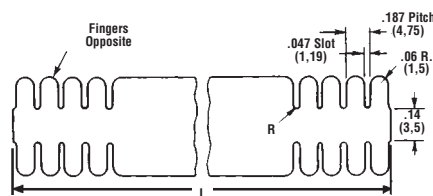
Contips available



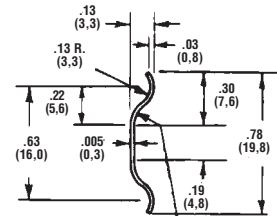
Figure B



97-105



97-115



Side View

Contips available

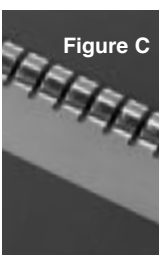
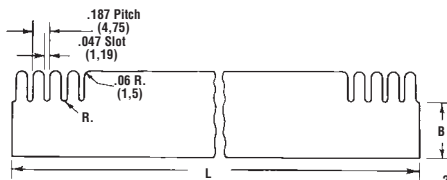
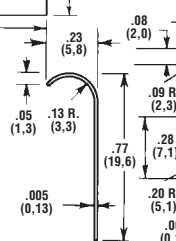


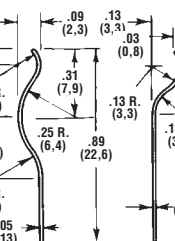
Figure C



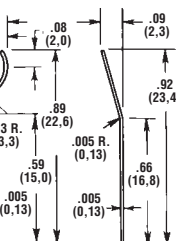
97-110



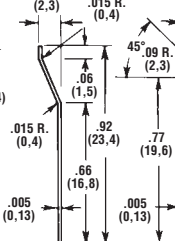
97-111



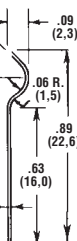
97-112



97-113



97-114



97-116

Contips available on 97-111, 97-112, 97-114 and 97-116 only

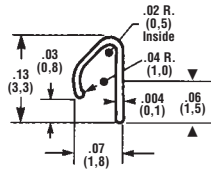
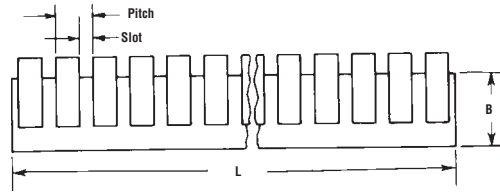
All dimensions shown are in inches (millimeters) unless otherwise specified.
For availability see pages 6–11.

Miscellaneous Mounting Contact Strips

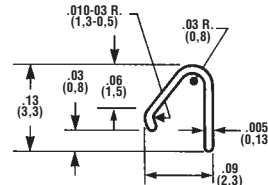


Figure D

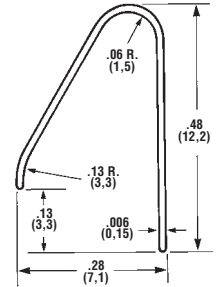
Not available with Contips®



97-221



97-251



97-310

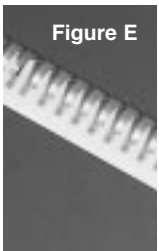
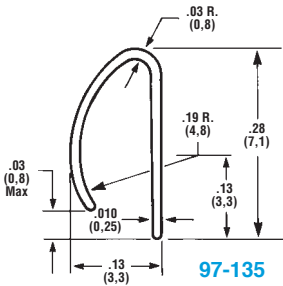
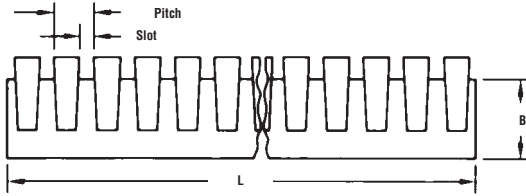
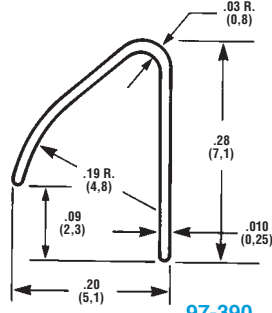


Figure E

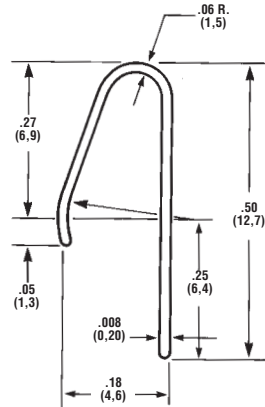
Not available with Contips



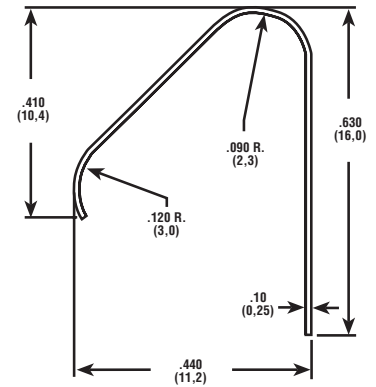
97-135



97-390



97-340



97-342

Flat Strip

Series	Fig.	Pitch	Slot	B	Approx. Length (L)	Approx. # of Fingers
97-105	B	0.187 (4,750)	0.047 (1,194)	—	16,000 (406,400)	86
97-110	C	0.187 (4,750)	0.047 (1,194)	0.590 (14,986)	16,000 (406,400)	86
97-111	C	0.187 (4,750)	0.047 (1,194)	0.630 (16,002)	16,000 (406,400)	86
97-112	C	0.187 (4,750)	0.047 (1,194)	0.570 (14,478)	16,000 (406,400)	86
97-113	C	0.187 (4,750)	0.047 (1,194)	0.630 (16,002)	16,000 (406,400)	86
97-114	C	0.187 (4,750)	0.047 (1,194)	0.650 (16,510)	16,000 (406,400)	86
97-115	B	0.187 (4,750)	0.047 (1,194)	—	16,000 (406,400)	86
97-116	C	0.187 (4,750)	0.047 (1,194)	0.630 (16,002)	16,000 (406,400)	86

Series	Fig.	Pitch	Slot	B	Approx. Length (L)	Approx. # of Fingers
97-117	A	0.187 (4,750)	0.047 (1,194)	—	16,000 (406,400)	86
97-135	E	0.135 (3,429)	0.040 (1,016)	0.230 (5,842)	16,000 (406,400)	119
97-221	D	0.060 (1,524)	0.020 (0,508)	0.090 (2,286)	12,000 (304,800)	200
97-251	D	0.127 (3,226)	0.050 (1,270)	0.090 (2,286)	12,000 (304,800)	95
97-300	A	0.165 (4,191)	0.040 (1,016)	0.190 (4,826)	16,000 (406,400)	97
97-310	D	0.187 (4,750)	0.062 (1,575)	0.380 (9,652)	15,000 (381,000)	86
97-340	E	0.163 (4,140)	0.020 (0,508)	0.250 (6,350)	16,000 (406,400)	98
97-342	E	0.134 (3,403)	0.047 (1,193)	0.500 (12,700)	16,000 (406,400)	119
97-390	E	0.134 (3,404)	0.040 (1,016)	0.230 (5,842)	16,000 (406,400)	119

All dimensions shown are in inches (millimeters) unless otherwise specified.
For availability see pages 6-11.



Miscellaneous Mounting Contact Strips



Figure F

Contips® available

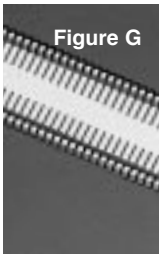
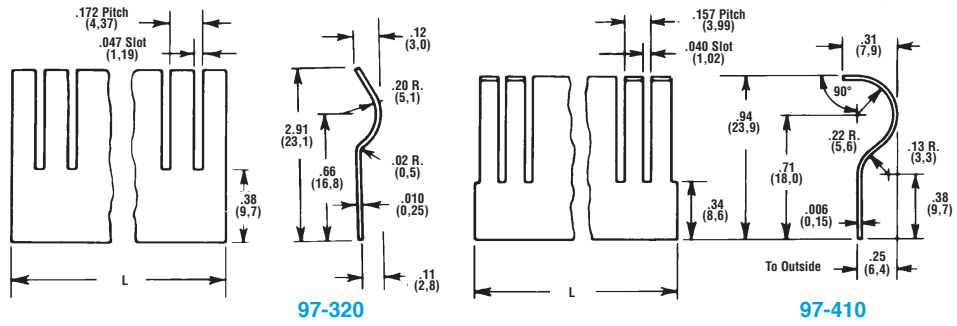


Figure G

Contips available

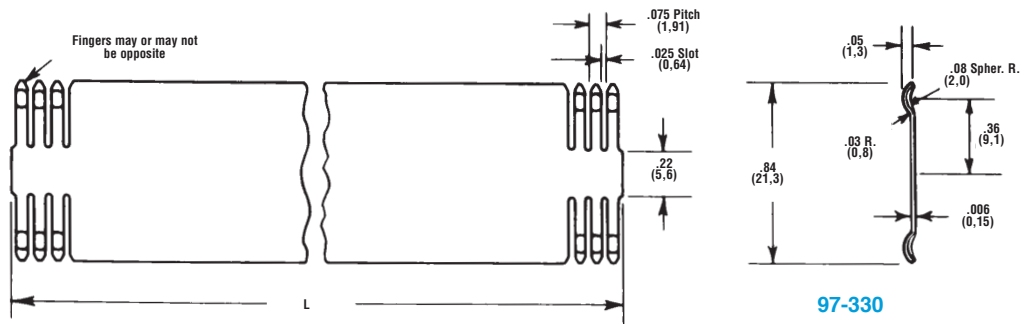


Figure H

Contips available

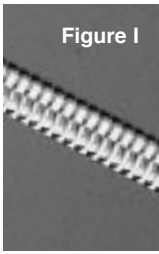
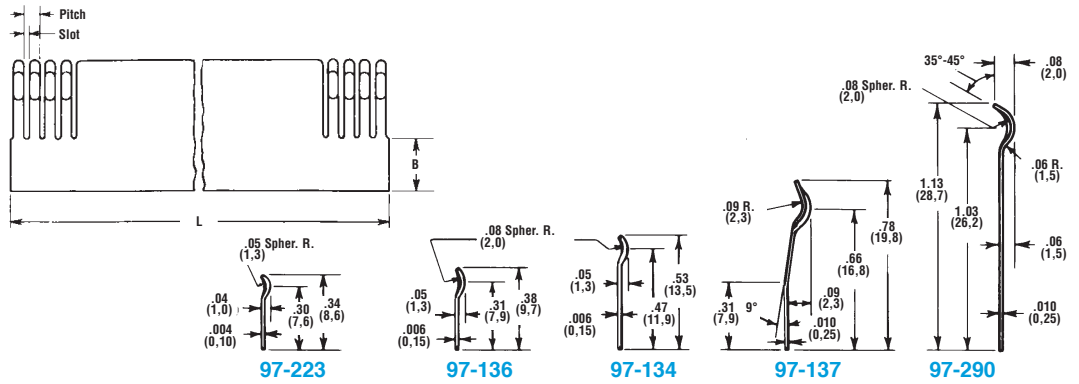
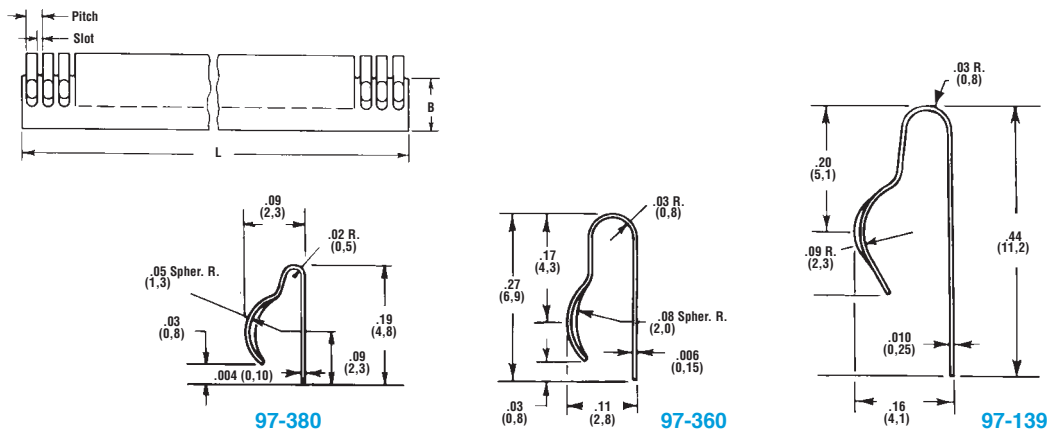


Figure I

Contips available



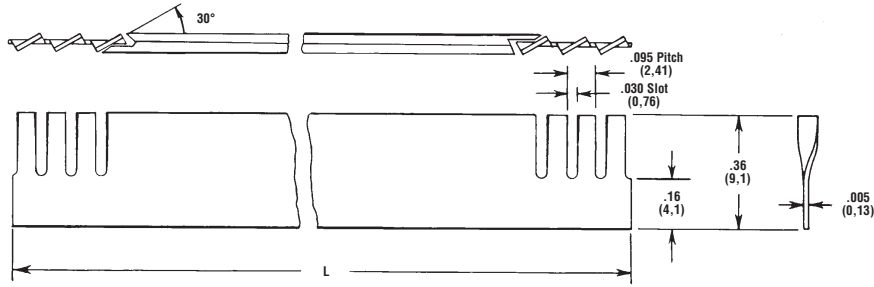
All dimensions shown are in inches (millimeters) unless otherwise specified.
For availability see pages 6-11.

Miscellaneous Mounting Contact Strips



Figure J

Not available with Contips®

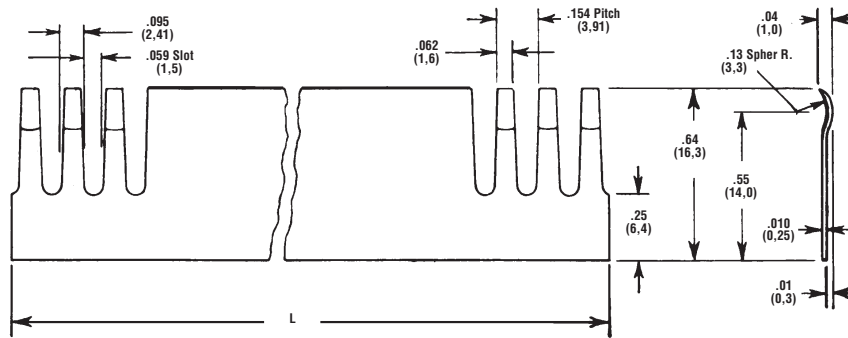


97-370



Figure K

Contips available



97-430

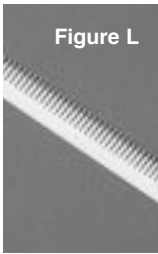
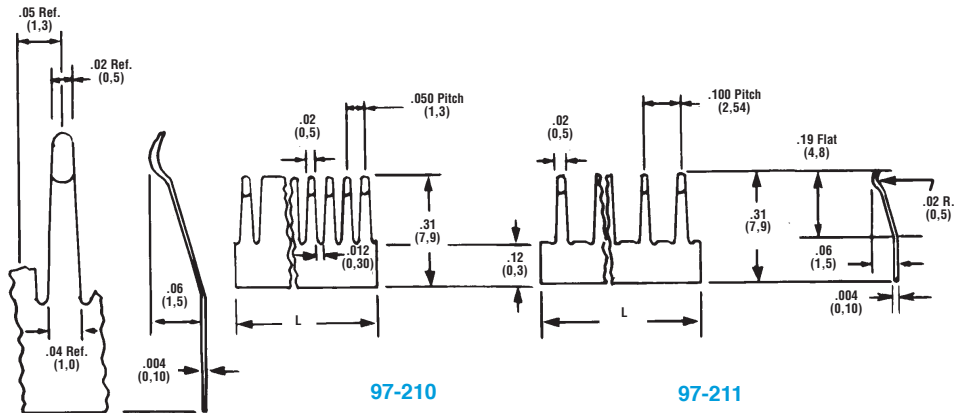


Figure L

Contips available



97-210

97-211

Flat Strip

Series	Fig.	Pitch	Slot	B	Approx. Length (L)	Approx. # of Fingers
97-134	H	0.075 (1,905)	0.025 (0,635)	0.220 (5,588)	16,000 (406,400)	213
97-136	H	0.075 (1,905)	0.025 (0,635)	0.060 (1,524)	16,000 (406,400)	213
97-137	H	0.094 (2,388)	0.031 (0,787)	0.310 (7,874)	16,000 (406,400)	170
97-139	I	0.094 (2,388)	0.031 (0,787)	0.310 (7,874)	16,000 (406,400)	170
97-210	L	0.050 (1,270)	0.012 (0,305)	0.120 (3,048)	12,000 (304,800)	240
97-211	L	0.100 (2,540)	0.062 (1,575)	0.120 (3,048)	12,000 (304,800)	120
97-223	H	0.060 (1,524)	0.020 (0,508)	0.130 (3,302)	16,000 (406,400)	267
97-290	H	0.075 (1,905)	0.025 (0,635)	0.690 (17,526)	16,000 (406,400)	213

Series	Fig.	Pitch	Slot	B	Approx. Length (L)	Approx. # of Fingers
97-320	F	0.172 (4,369)	0.047 (1,194)	0.380 (9,652)	16,000 (406,400)	93
97-330	G	0.075 (1,905)	0.025 (0,635)	-	16,000 (406,400)	213
97-360	I	0.075 (1,905)	0.025 (0,635)	0.220 (5,588)	16,000 (406,400)	213
97-370	J	0.095 (2,413)	0.030 (0,762)	-	16,000 (406,400)	168
97-380	I	0.060 (1,524)	0.020 (0,508)	0.130 (3,302)	16,000 (406,400)	267
97-410	F	0.157 (3,988)	0.040 (1,016)	0.340 (8,636)	16,000 (406,400)	102
97-430	K	0.154 (3,912)	0.059 (1,499)	0.250 (6,350)	16,000 (406,400)	104

All dimensions shown are in inches (millimeters) unless otherwise specified.
For availability see pages 6-11.

Miscellaneous Mounting Contact Rings

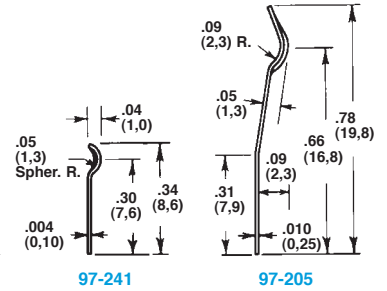
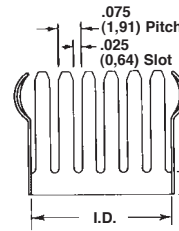
Male Rings

Series	Pitch	Slot	ID	≈ # of Fing.	Rec. Hole Size	B	Made From Strip
97-150	0.075 (1,905)	0.025 (0,635)	0.210 (5,334)	9	0.250 (6,350)	0.220 (5,588)	97-134
97-151	0.075 (1,905)	0.025 (0,635)	0.330 (8,382)	14	0.380 (9,652)	0.220 (5,588)	97-134
97-152	0.075 (1,905)	0.025 (0,635)	0.450 (11,430)	19	0.500 (12,700)	0.220 (5,588)	97-134
97-153	0.075 (1,905)	0.025 (0,635)	0.690 (17,526)	29	0.750 (19,050)	0.220 (5,588)	97-134
97-154	0.075 (1,905)	0.025 (0,635)	0.950 (24,130)	40	1.000 (25,400)	0.220 (5,588)	97-134
97-155	0.075 (1,905)	0.025 (0,635)	1.450 (36,830)	61	1.500 (38,100)	0.220 (5,588)	97-134
97-156	0.075 (1,905)	0.025 (0,635)	1.950 (49,530)	82	2.000 (50,800)	0.220 (5,588)	97-136
97-192	0.075 (1,905)	0.025 (0,635)	0.450 (11,430)	19	0.500 (12,700)	0.060 (1,524)	97-136
97-205	0.094 (2,388)	0.031 (0,787)	0.890 (22,606)	30	1.000 (25,400)	0.310 (7,874)	97-137
97-215	0.094 (2,388)	0.031 (0,787)	1.240 (31,496)	42	1.500 (38,100)	0.310 (7,874)	97-139
97-241	0.060 (1,524)	0.020 (0,508)	0.340 (8,636)	18	0.380 (9,652)	0.130 (3,302)	97-223

- Wide variety of finger size, contours, and ring diameters
- Contact rings are formed from contact strips
- Contips® version available, which includes localized deposits of silver or gold to enhance conductivity
- Rings are used for connector shields; single fingers of strips can be used as battery contacts

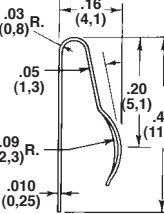


Contips available

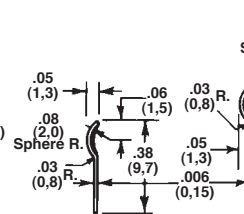


Female Rings

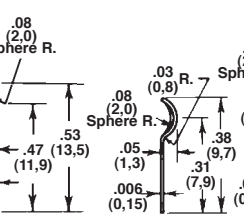
Series	Pitch	Slot	OD	≈ # of Fing.	Rec. Pin Dia.	B	Made From Strip	Sm. Dia. From Strip
97-076	0.163 (4,140)	0.020 (0,508)	0.640 (16,256)	12	0.340 (8,636)	0.250 (6,350)	97-340	0.640 (16,256)
97-140	0.075 (1,905)	0.025 (0,635)	0.290 (7,366)	12	0.250 (6,350)	0.220 (5,588)	97-134	0.200 (5,080)
97-141	0.075 (1,905)	0.025 (0,635)	0.440 (11,176)	18	0.380 (9,652)	0.220 (5,588)	97-134	0.200 (5,080)
97-142	0.075 (1,905)	0.025 (0,635)	0.550 (13,970)	23	0.500 (12,700)	0.220 (5,588)	97-134	0.200 (5,080)
97-143	0.075 (1,905)	0.025 (0,635)	0.800 (20,320)	33	0.750 (19,050)	0.220 (5,588)	97-134	0.200 (5,080)
97-185	0.075 (1,905)	0.025 (0,635)	0.560 (14,224)	23	0.500 (12,700)	0.060 (1,524)	97-136	0.200 (5,080)
97-204	0.094 (2,388)	0.031 (0,787)	1.040 (26,416)	34	1.000 (25,400)	0.310 (7,874)	97-137	0.460 (11,684)
97-216	0.094 (2,388)	0.031 (0,787)	1.240 (31,496)	41	1.000 (25,400)	0.300 (7,620)	97-139	0.940 (23,876)
97-232	0.060 (1,524)	0.020 (0,508)	0.540 (13,716)	28	0.500 (12,700)	0.130 (3,302)	97-233	— (4,064)
97-252	0.127 (3,226)	0.050 (1,270)	1.250 (31,750)	31	1.090 (27,686)	0.090 (2,286)	97-251	0.450 (11,430)
97-254	0.127 (3,226)	0.050 (1,270)	0.910 (23,114)	22	0.740 (18,796)	0.090 (2,286)	97-251	0.450 (11,430)
97-255	0.127 (3,226)	0.050 (1,270)	0.650 (16,510)	16	0.480 (12,192)	0.090 (2,286)	97-251	0.450 (11,430)
97-361	0.075 (1,905)	0.025 (0,635)	1.010 (25,654)	42	0.840 (21,336)	0.220 (5,588)	97-360	0.610 (15,494)
97-381	0.060 (1,524)	0.020 (0,508)	1.210 (30,734)	63	1.060 (26,924)	0.130 (3,302)	97-380	0.460 (11,684)
97-420	0.190 (4,826)	0.075 (1,905)	0.500 (12,700)	8	0.320 (8,128)	0.060 (1,524)	—	0.500 (12,700)
97-421	0.100 (2,540)	0.050 (1,270)	0.500 (12,700)	15	0.370 (9,398)	0.070 (1,778)	—	0.440 (11,176)
97-422	0.154 (3,912)	0.059 (1,499)	0.600 (15,240)	12	0.370 (9,398)	0.250 (6,350)	—	0.550 (13,970)
97-423	0.154 (3,912)	0.059 (1,499)	0.780 (19,812)	15	0.540 (13,716)	0.250 (6,350)	—	0.550 (13,970)
97-424	0.135 (3,429)	0.040 (1,016)	1.050 (26,670)	24	0.810 (20,574)	0.230 (5,842)	—	0.870 (22,098)



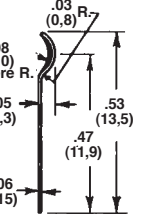
97-215



97-185



97-140 to 143

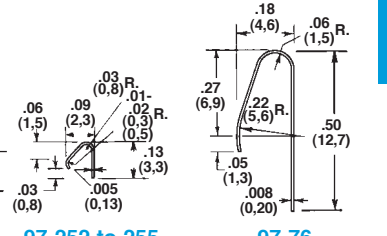
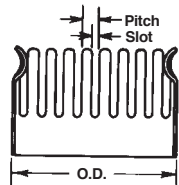


97-192

97-150 to 156

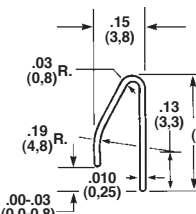


Contips available

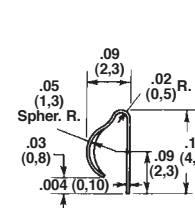


97-252 to 255

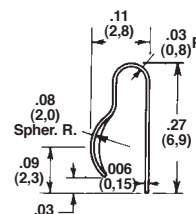
97-76



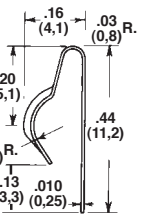
97-422 to 424



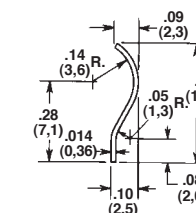
97-381



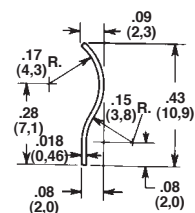
97-361



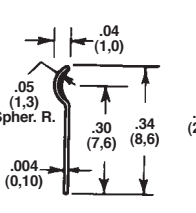
97-216



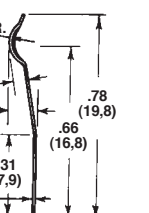
97-420



97-421



97-232



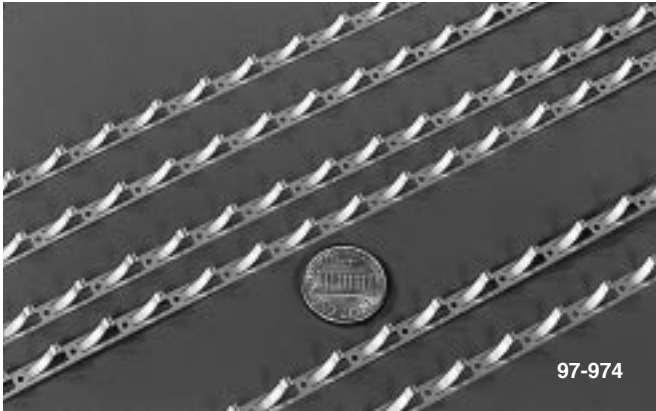
97-204

All dimensions shown are in inches (millimeters) unless otherwise specified.
For availability see pages 6-11.



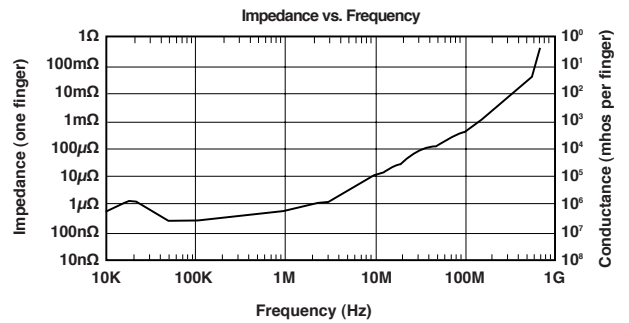
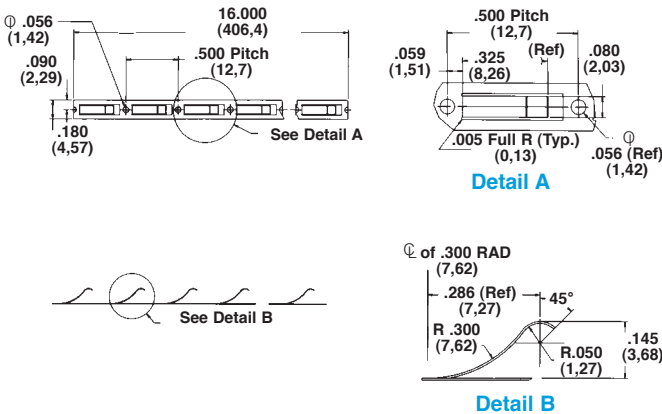
Miscellaneous Mounting

Mini-Longitudinal Grounding Gasket



Mini-Longitudinal Grounding Gasket (97-974)

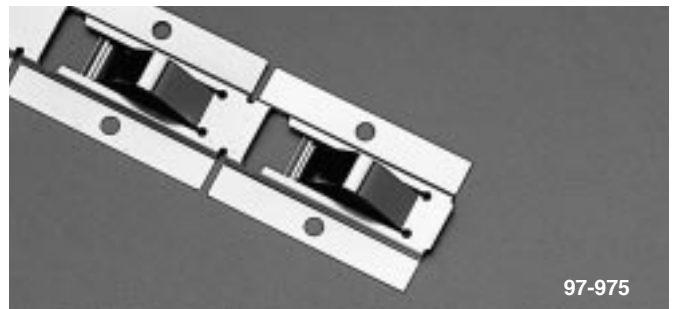
- Designed to accommodate small applications which often require lower compression forces
- Miniaturized design includes extremely narrow width and low standing height
- Allows longitudinal sliding motion over the length of the gasket
- Mounting methods include conductive tapes, rivets, or screws



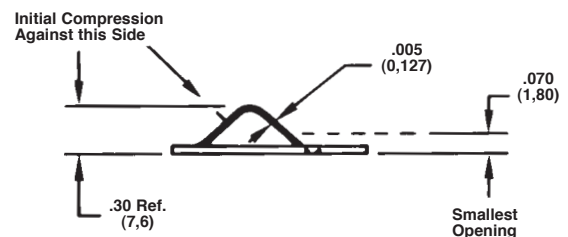
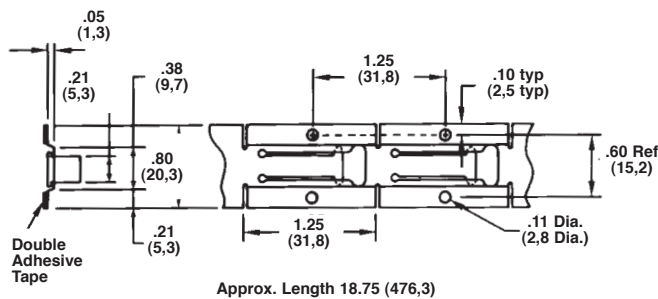
Miscellaneous Mounting

Longitudinal Grounding Series (97-975)

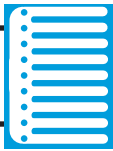
- Provides finger compression with the direction of motion in the longitudinal axis
- Ideal for use with rack-mounted and slide drawer assemblies
- Typical installation methods include hardware mounting or use of the Sticky Fingers® self-adhesive strip



Series 97-975



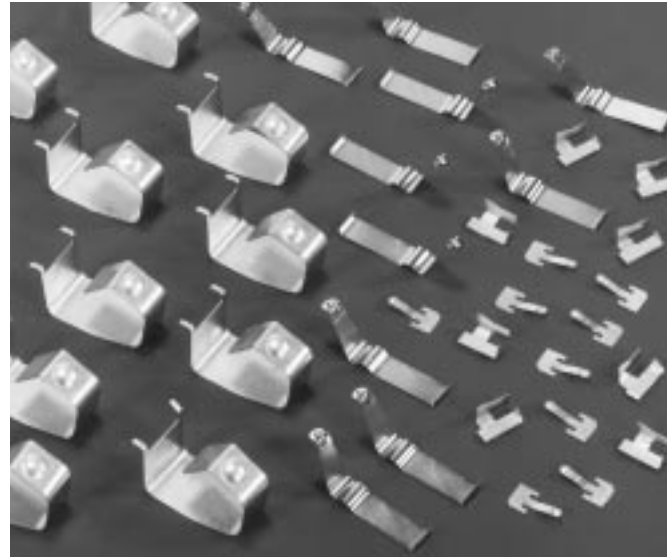
All dimensions shown are in inches (millimeters) unless otherwise specified.
For availability see pages 6-11.



Miscellaneous Mounting Battery Contacts

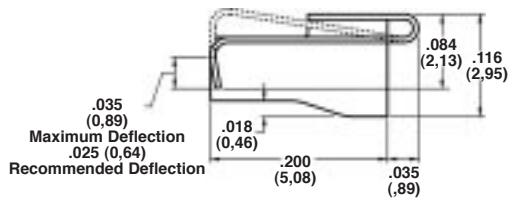
- Designed for coin battery, battery pack, and AA/AAA battery applications
- High performance standard size battery contacts
- Surface mountable and through-hole versions available

97-487/97-488 Coin Battery Applications



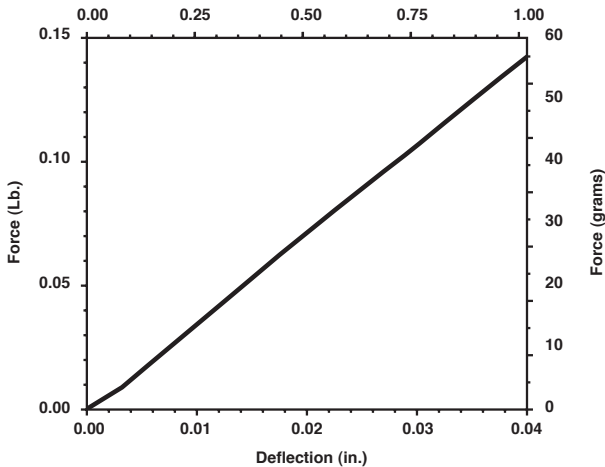
97-487

Top View



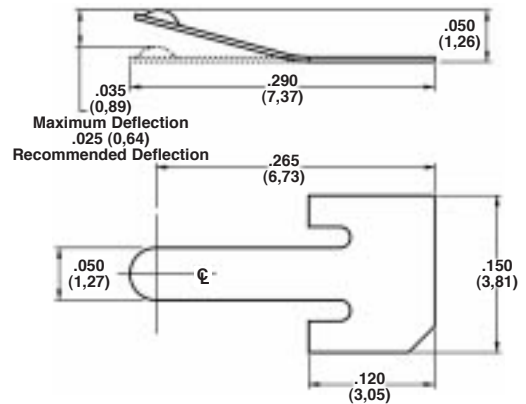
Side View

Force vs. Deflection
Part No: 97-487
Deflection (mm)



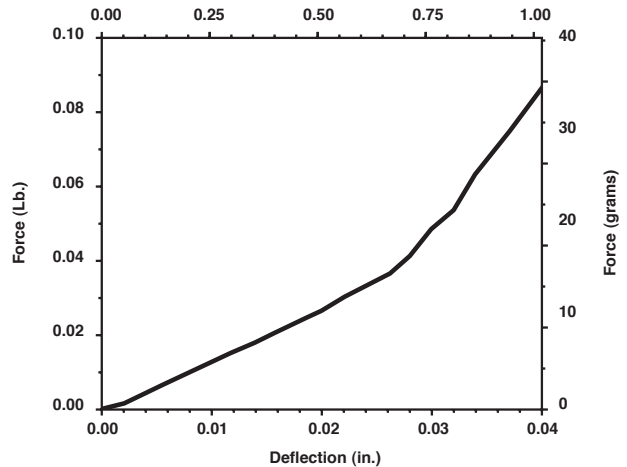
97-488

Side View



Top View

Force vs. Deflection
Part No: 97-488
Deflection (mm)



All dimensions shown are in inches (millimeters) unless otherwise specified.
For availability see pages 6-11.

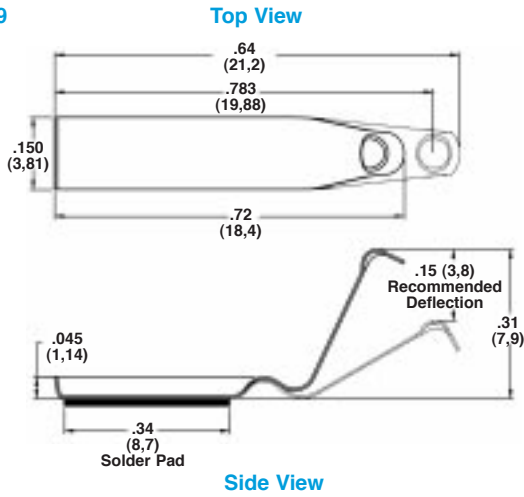


Miscellaneous Mounting Battery Contacts

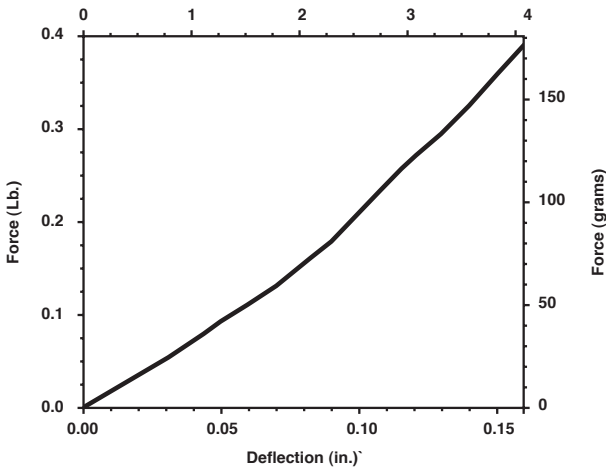
97-489 Battery Pack Contacts



97-489



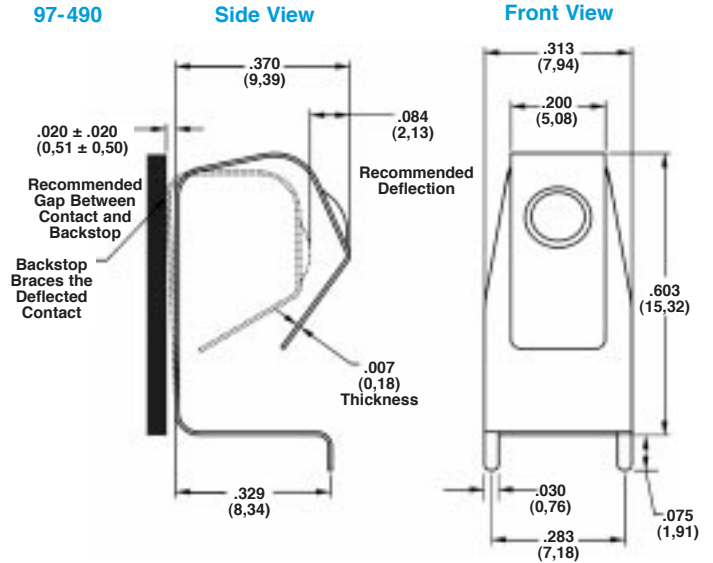
Force vs. Deflection
Part No: 97-489
Deflection (mm)



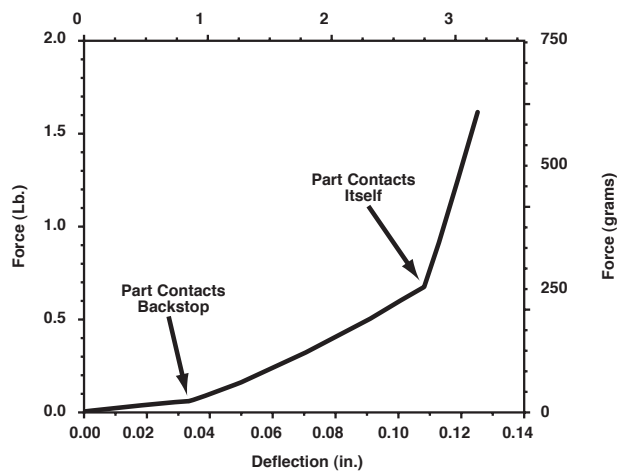
97-490 – AA/AAA Battery Contact Applications



97-490



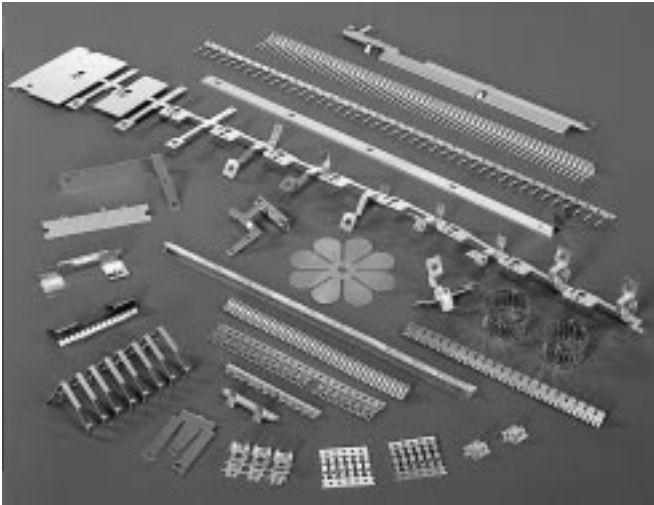
Force vs. Deflection
Part No: 97-490
Deflection (mm)



All dimensions shown are in inches (millimeters) unless otherwise specified.
For availability see pages 6–11.



Custom Stamping



Our CAD helps you fine-tune your initial designs. Our finite element analysis (FEA) simulates the performance of that design under actual working conditions. Our CNC equipment helps produce precisely fabricated samples. Our optical gauging inspection system ensures that the latest measurement technology is used to measure your parts. Computer programmable high-speed Bruderer punch presses enable our progressive dies to produce

families of parts economically by eliminating the need for costly multiple dies. The result: Laird Technologies can meet your custom stamping needs with the shortest, most reliable lead times in the industry.

Short Runs a Specialty

With Laird Technologies you get complete prototype and low-volume expertise. Our capabilities range from photo-etching and secondary stamping to an extensive selection of universal tooling and short-run production systems.

Laird Technologies Does It All

We provide full in-house tool and die design and manufacturing capabilities including CAD, CAM, and the high-precision tolerances of wire EDM. We manufacture custom components for many products, including connectors, switches, and electronic and electromechanical assemblies. Platings—from gold to zinc—are also a part of our capability. No wonder some of the world's leading electronics, aerospace, automotive, and instrumentation companies turn to Laird Technologies for custom-engineered stampings.

For more information on custom products, contact the Laird Technologies sales department.

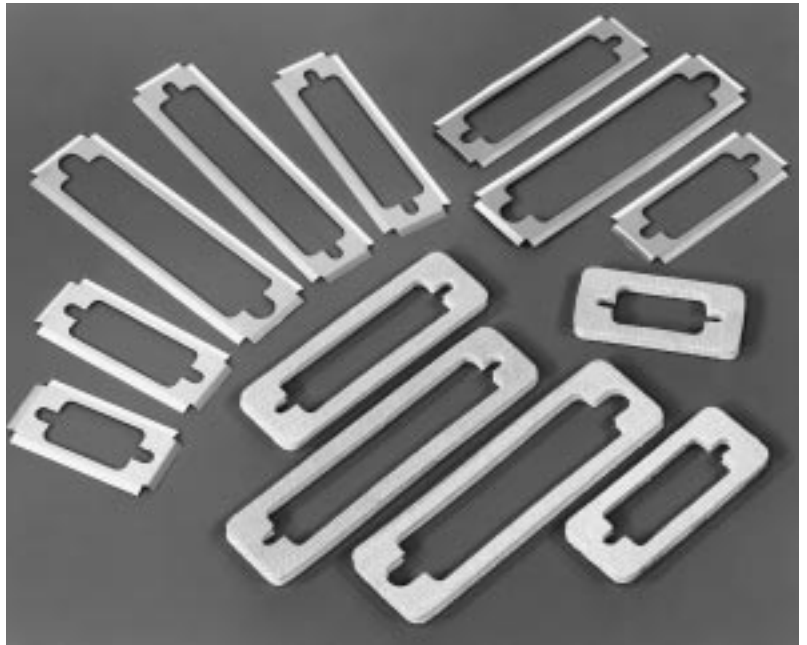


Notes





Metal Connector Shields



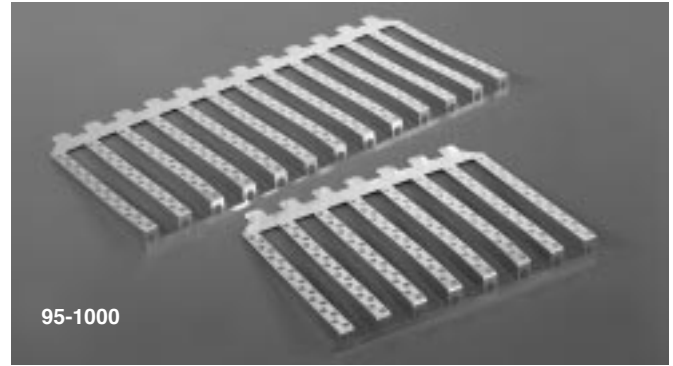
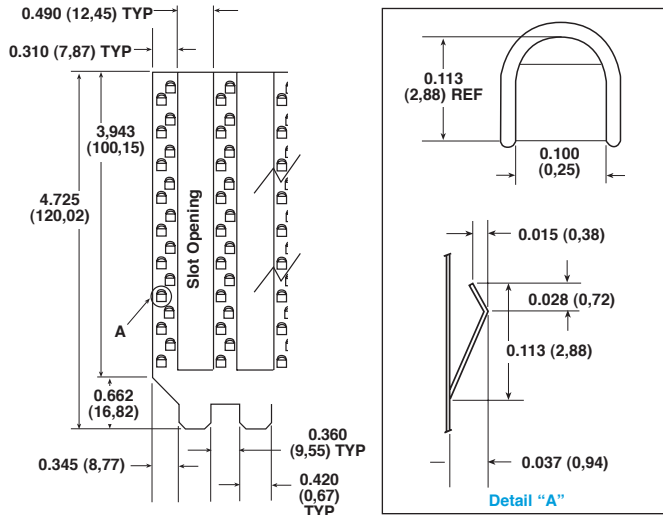
Stainless Steel I/O Shielding	45
“D” Connector Series	45
DIN Connector Shield	46
IEEE 1394 Horizontal Connector Gasket	47
Fiber Optic Shield	48
GBIC Fiber Optic Shield	48
USB Type B Connector	49



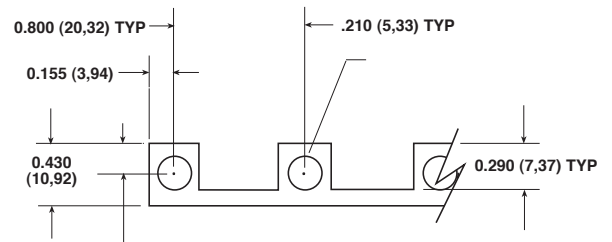


Metal Connector Shields Stainless Steel I/O Shielding

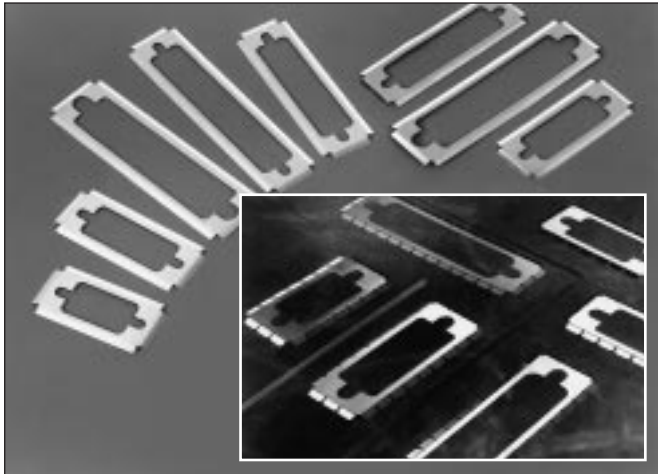
- Provides a single-piece solution to shield multiple connector slots in equipment backplanes
- Available in 1 to 21 slot configurations with customized versions readily provided
- Contact fingers provide excellent grounding path



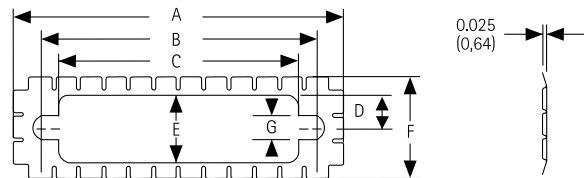
Top View



Metal Connector Shields "D" Connector Series

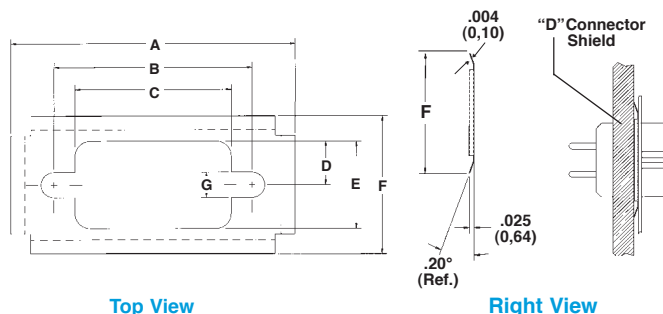


- Available in 9-pin to 68-pin "D" connector styles
- Angled flange design provides continuous contact to enclosure



"D" Connector Series Dimensions for BeCu and Stainless Steel

SS	BeCu	# Pins	A	B	C	D	E	F	G
95-822	97-822	9	1,410 (35,810)	0,980 (24,890)	0,780 (19,810)	0,220 (5,590)	0,440 (11,180)	0,690 (17,530)	0,160 (4,060)
95-823	97-823	9	1,410 (35,810)	0,980 (24,890)	0,780 (19,810)	0,180 (4,570)	0,350 (8,890)	0,690 (17,530)	0,160 (4,060)
95-824	97-824	15	1,740 (44,200)	1,310 (33,270)	1,110 (28,200)	0,220 (5,590)	0,440 (11,180)	0,690 (17,530)	0,160 (4,060)
95-825	97-825	15	1,740 (44,200)	1,310 (33,270)	1,110 (28,200)	0,180 (4,570)	0,350 (8,890)	0,690 (17,530)	0,160 (4,060)
95-826	97-826	25	2,280 (57,910)	1,850 (47,000)	1,650 (41,910)	0,220 (5,590)	0,440 (11,180)	0,690 (17,530)	0,160 (4,060)
95-827	97-827	25	2,280 (57,910)	1,850 (47,000)	1,650 (41,910)	0,180 (4,570)	0,350 (8,890)	0,690 (17,530)	0,160 (4,060)
95-828	97-828	37	2,930 (74,420)	2,500 (63,500)	2,290 (58,170)	0,220 (5,590)	0,440 (11,180)	0,690 (17,530)	0,160 (4,060)
95-829	97-829	37	2,930 (74,420)	2,500 (63,500)	2,290 (58,170)	0,180 (4,570)	0,350 (8,890)	0,690 (17,530)	0,160 (4,060)



"D" Connector Series Dimensions for BeCu and Stainless Steel

SS	BeCu	# Pins	A	B	C	D	E	F	G
97-768	97-778	9	1,410 (35,814)	0,980 (24,892)	0,780 (19,812)	0,220 (5,588)	0,440 (11,176)	0,690 (17,526)	0,130 (3,302)
97-769	97-779	15	1,740 (44,196)	1,310 (33,274)	1,110 (28,194)	0,220 (5,588)	0,440 (11,176)	0,690 (17,526)	0,130 (3,302)
97-770	97-780	25	2,280 (57,912)	1,850 (46,990)	1,650 (41,910)	0,220 (5,588)	0,440 (11,176)	0,690 (17,526)	0,130 (3,302)
97-771	97-781	37	2,930 (74,422)	2,500 (63,500)	2,290 (58,166)	0,220 (5,588)	0,440 (11,176)	0,690 (17,526)	0,130 (3,302)
97-772	97-782	50	2,840 (72,136)	2,410 (61,214)	2,110 (53,594)	0,280 (7,112)	0,550 (13,970)	0,800 (20,320)	0,240 (6,096)
97-773	97-783	68	1,800 (45,720)	1,480 (37,592)	1,260 (32,004)	0,080 (2,032)	0,160 (4,064)	0,400 (10,160)	0,090 (2,286)

All dimensions shown are in inches (millimeters) unless otherwise specified. For availability see pages 6-11.

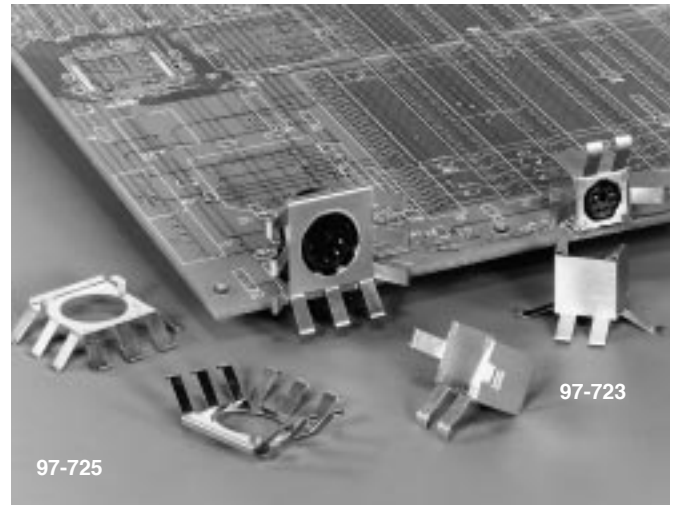
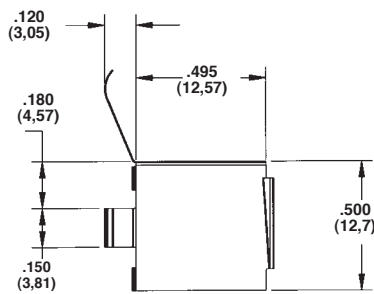
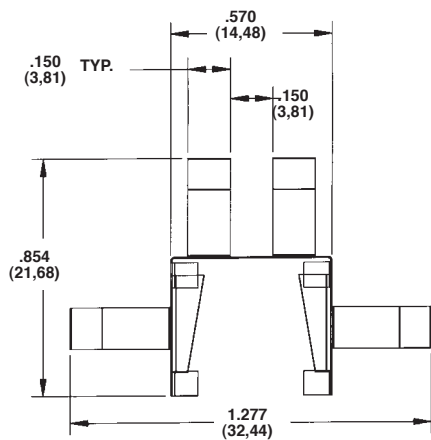
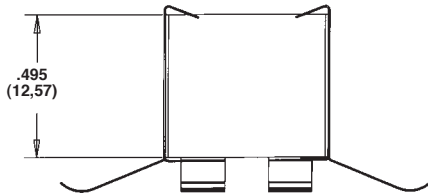




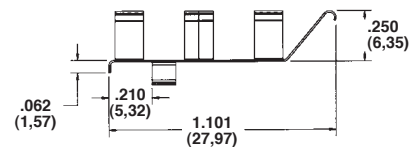
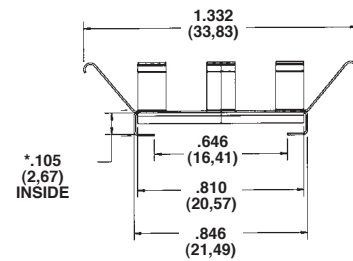
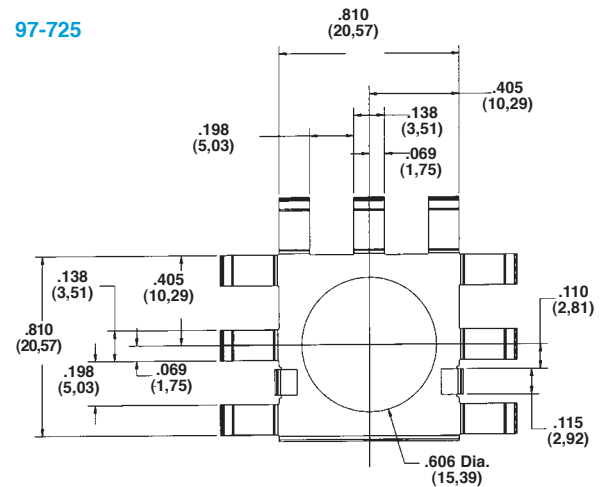
Metal Connector Shields DIN Connector Series

- Slide-on design for easy assembly to connector
- Grounds DIN connector plugs to chassis and PCBs

97-723

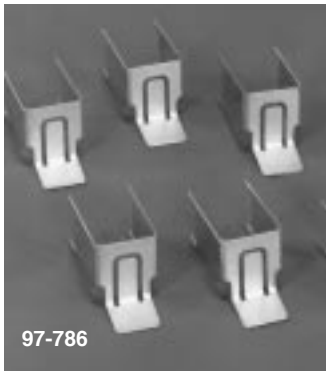


97-725



*97-725 is available without the formed bends or with bends of varying sizes to accommodate your requirements for a variety of connector sizes.

All dimensions shown are in inches (millimeters) unless otherwise specified.
For availability see pages 6-11.



97-786

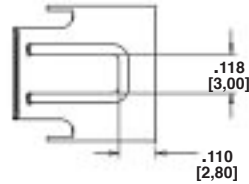


97-787

- Available in horizontal and vertical connector styles
- Accommodates a wide range of IEEE 1394 connector positions
- Packaged in trays to facilitate pick and place operations

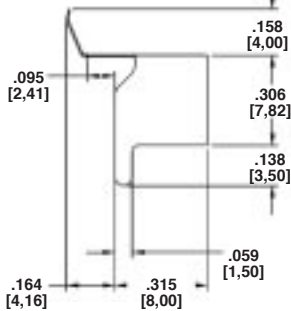
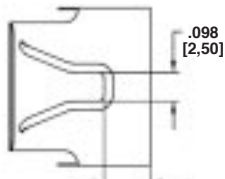
97-786

Top

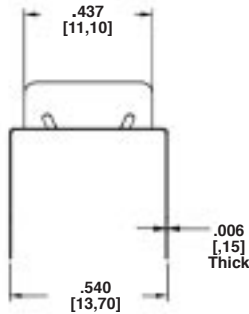


97-787

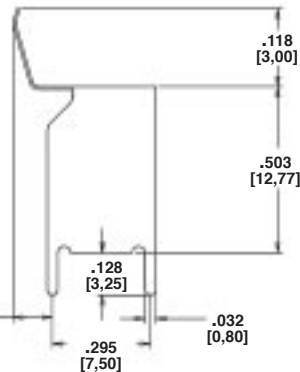
Top View



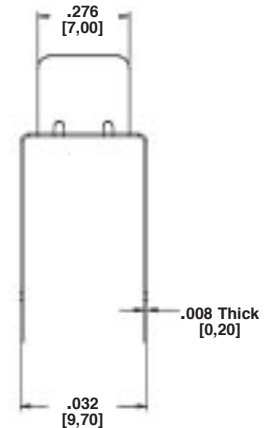
Right Side



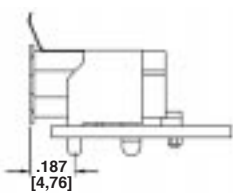
Front View



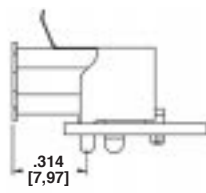
Front



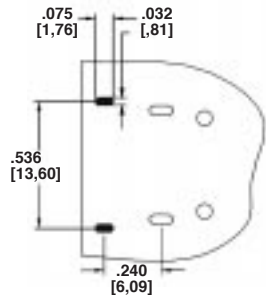
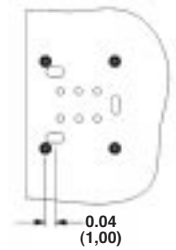
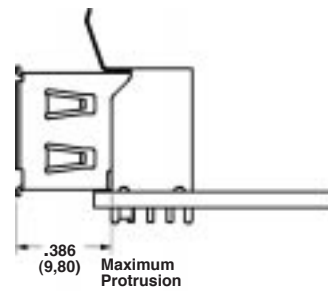
Right Side



Minimum Connector Protrusion



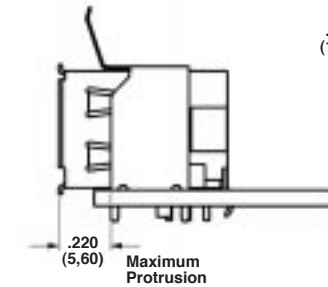
Maximum Connector Protrusion



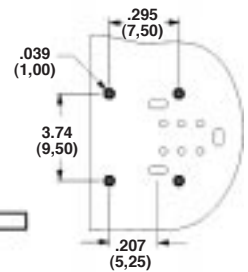
Top View: Minimum Protrusion PCB Layout



Top View: Maximum Protrusion PCB Layout



Side View: Connector Gasket Assembly



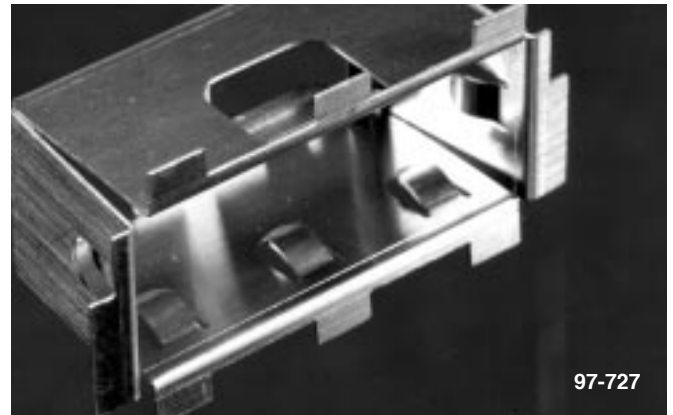
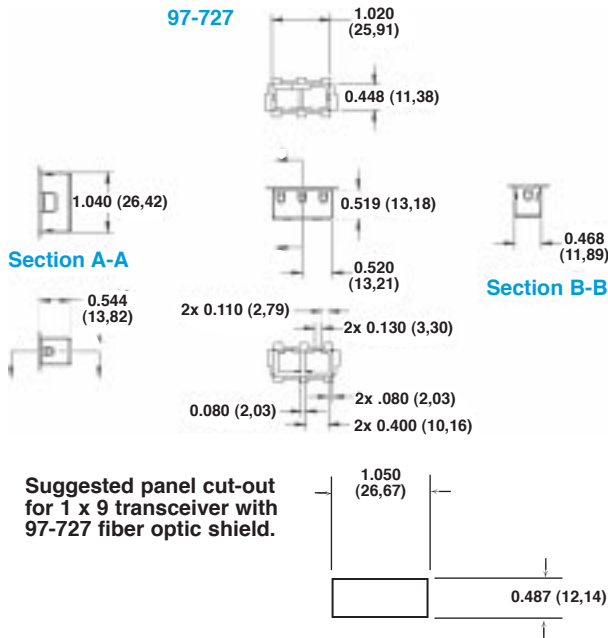
Printed Circuit Board Layout

All dimensions shown are in inches (millimeters) unless otherwise specified.
 For availability see pages 6-11.



Metal Connector Shields Fiber Optic Shield

- Fits all 1 x 9 style fiber optic transceivers with duplex SC connectors
- Provides shielding around the faceplate aperture which houses board-mounted fiber optic transceivers

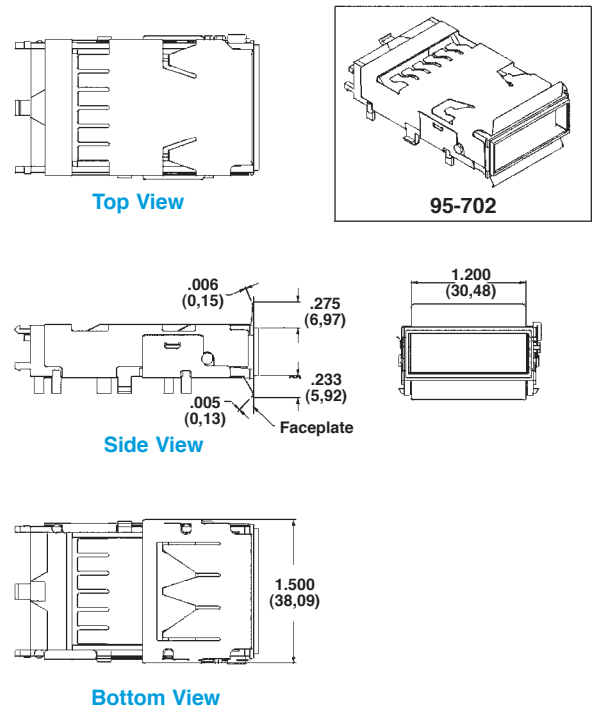


97-727



Metal Connector Shields GBIC Fiber Optic Shield

- Conducts emission away from GBIC (Gigabit Interface Converter) transceivers
- Two-piece design easily snaps on to most Tyco™ (Amp®) and Methode® guide rails
- Stainless steel construction for high galvanic compatibility

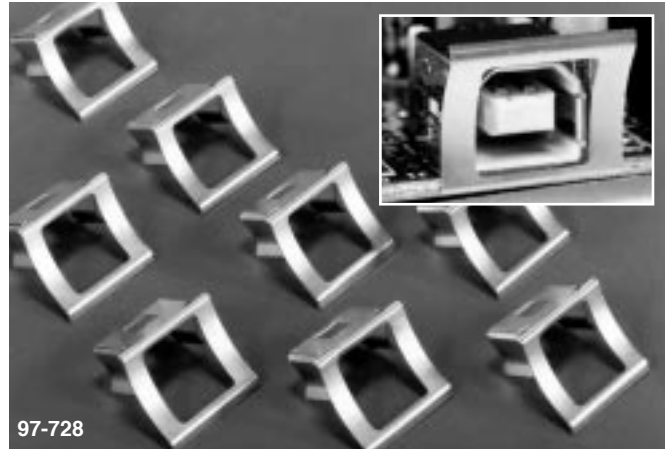
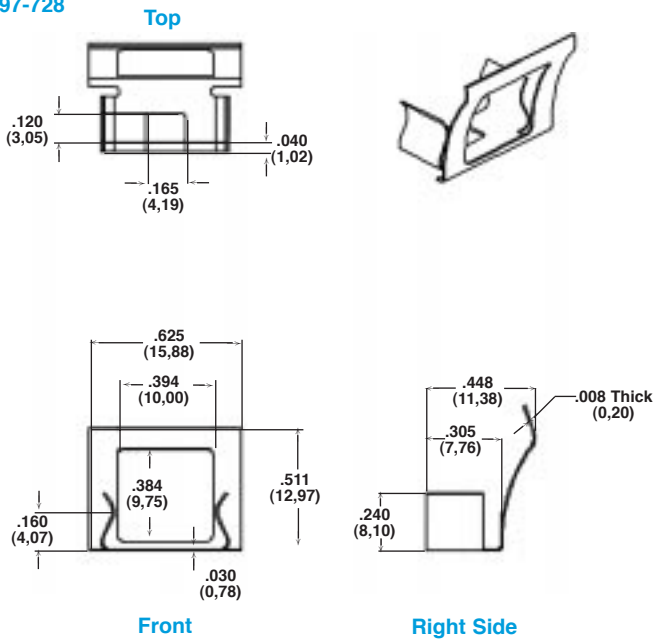


All dimensions shown are in inches (millimeters) unless otherwise specified.
For availability see pages 6–11.



Metal Connector Shields USB Type B Connector

97-728



- Snaps onto connector prior to placement on the PCB
- Fits all right-angle USB connectors



Notes

All dimensions shown are in inches (millimeters) unless otherwise specified.
For availability see pages 6-11.





Notes

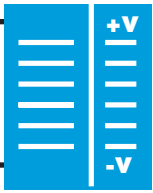




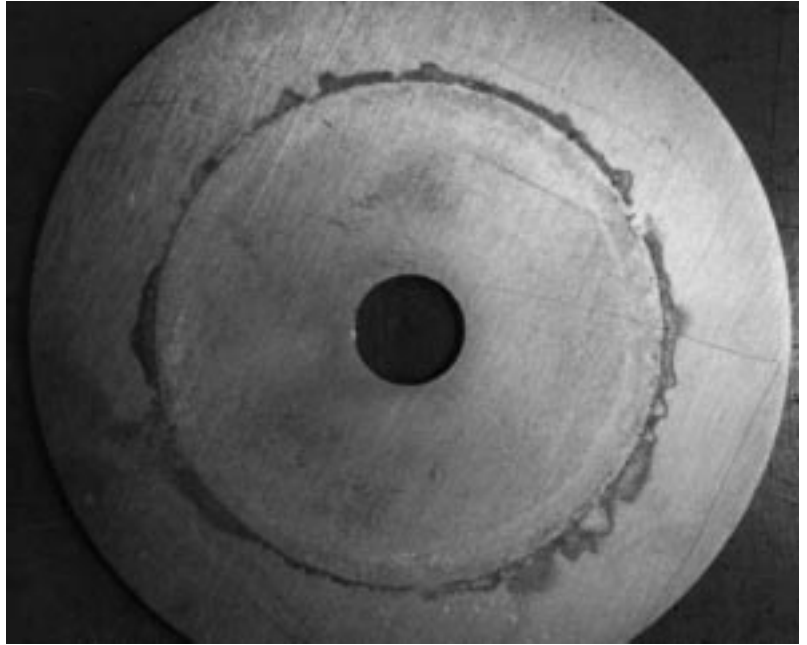
Notes



All dimensions shown are in inches (millimeters) unless otherwise specified.
For availability see pages 6–11.



Corrosion of EMI Gaskets



Corrosion of EMI Gaskets

53

Metals Galvanic Compatibility Chart

54





Galvanic Corrosion of Metals

The galvanic series is a common means of ranking the relative activity of metallic couples. The galvanic series does not provide a measure of the corrosion current which will flow in a dissimilar metal couple, but it does indicate which couples are likely to incur significant corrosion damage. In galvanic couples consisting of two very incompatible metals, it is possible to reduce the corrosion rate through good design practice. In this situation, it is best to maximize the ratio of anode to cathode surface areas. For a particular current density, the corrosion rate on the more anodic metal will be lower the larger this ratio, because the corrosion reaction is spread over a larger surface area. In addition, if corrosion products build up on the cathode, they will build at a faster rate the smaller the surface area of the cathode relative to the anode. In this situation, the deposits could create a barrier that slows down corrosion.

The above technique is used in reverse to enhance the performance of electrical contacts. It is desirable that electrical contacts remain clean to provide a low resistance connection. When corrosion occurs, metal is removed from the more anodic metal. This process cleans the more anodic metal. By making the electrical contact out of one metal, and surrounding it by a larger surface area of a more cathodic metal, the contact will be cleaned by the corrosion reaction. The contact may corrode away eventually, but it will function more reliably during its shortened life.

The probability that two dissimilar metals will corrode when coupled together can be predicted from their difference in the electrochemical potentials. This information is tabulated in the Metals Galvanic Compatibility Chart on page 54. The common metals and their anodic index are listed along the left side of the chart. The metals are grouped in 0.05 volt increments, with some of the groups containing no common metals. Group Number One (left hand column) contains the most cathodic metals and has an anodic index of zero. The anodic index increases as metals become more anodic. The arrow (on the far right

hand side of the chart) points in the direction of increasingly anodic metals. On the right side of the chart, typical finishes available on metallic parts manufactured by Laird Technologies are listed along the top. The colored bars indicate the galvanic compatibility of these common finishes to the metals listed on the left. The color code is based on both the electrochemical differences between the metals and the finishes, and the corrosiveness of the environment. The chart shows that the force that drives the corrosion reactions is directly related to the electrochemical difference between any two metals. By reducing this difference, the corrosion rate is decreased.

Basic Corrosion Prevention

Whenever possible, avoid the use of dissimilar metals. The following five steps may be taken to prevent, or at least minimize corrosion potential in the event that it is necessary to use dissimilar metals in intimate contact with one another:

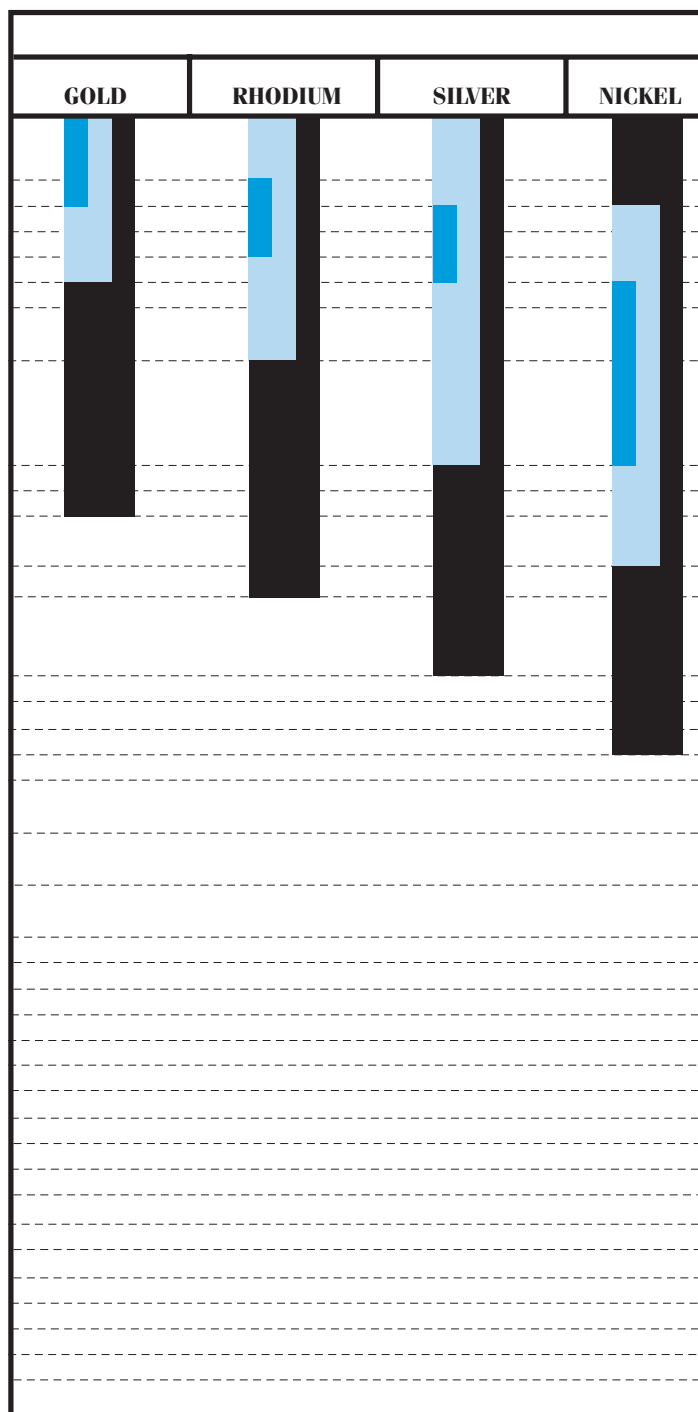
1. Limit contact between metals with widely different electrochemical potentials. The Metals Galvanic Compatibility Chart, on page 54, indicates which metal pairs have large differences in electrochemical potential.
2. Insert a third metal between the two dissimilar metals which reduces the potential difference of the galvanic couple. For example, nickel or tin plated copper are suitable for use with aluminum and silver combinations.
3. Design the flange interface so that the surface area of the anodic metal is significantly larger than the cathodic metal. The electromotive force (EMF) difference remains the same. However, the current density is decreased, so the corrosive attack on the cathodic metal is reduced.
4. Eliminate moisture, salts and other electrolytes from entering the joint interface by improved flange design or, if not possible, use an environmental seal outboard of the conductive element in a dual EMI shield/environmental seal.





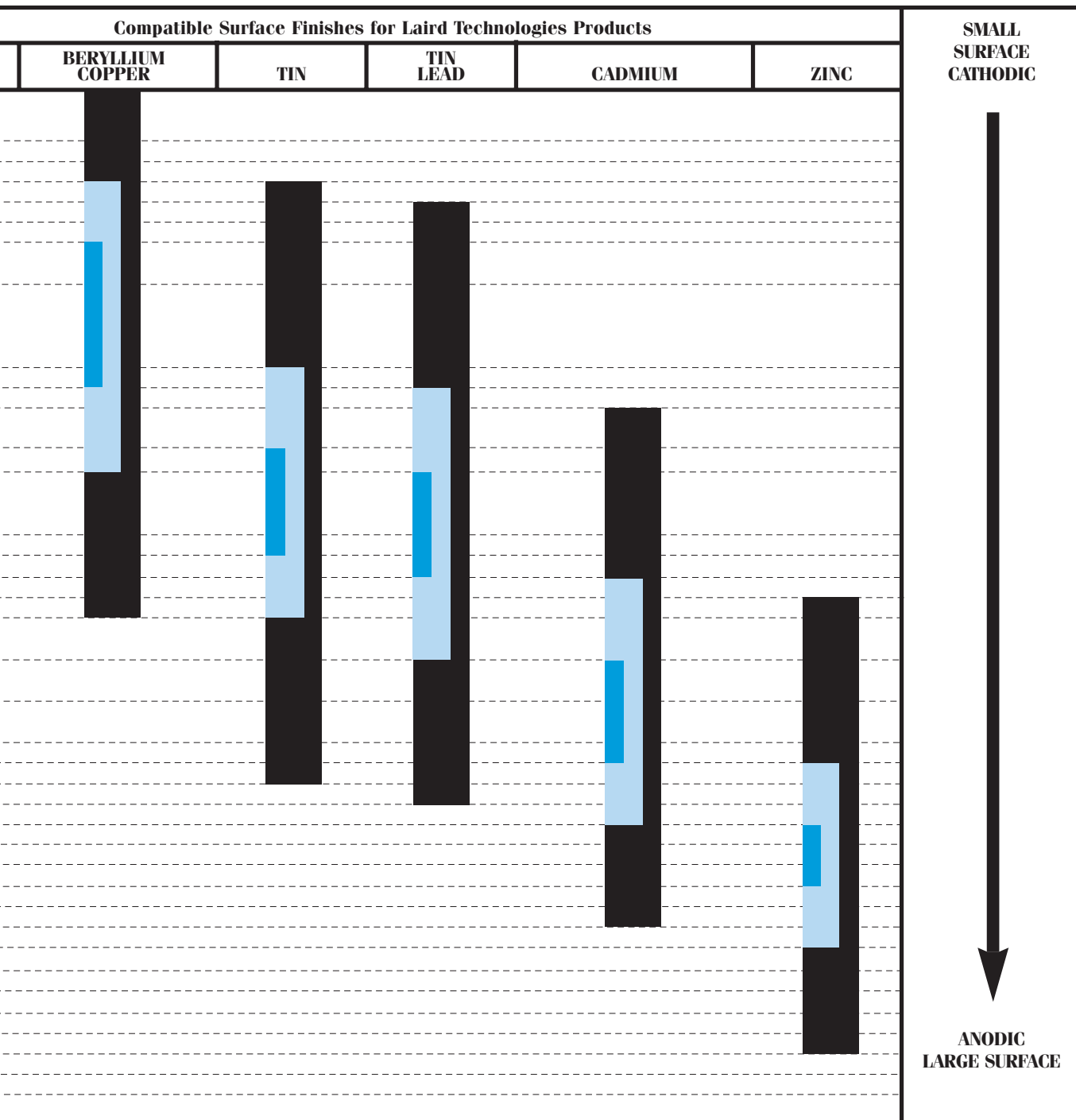
Metals Galvanic Compatibility Chart


GROUP NUMBER	Common Metal Surfaces METALLURGICAL CATEGORY	ANODIC INDEX, V
1	Gold; Au-Pt alloys; wrought platinum; graphite carbon	0.00
2		0.05
3	Rhodium plating	0.10
4	Silver; high-silver alloys	0.15
5		0.20
6		0.25
7	Nickel; nickel-copper alloys; titanium, titanium alloys; Monel	0.30
8	Beryllium copper; low brasses or bronzes; silver solder; copper; Ni-Cr alloys; austenitic corrosion-resistant steels; most chrome-moly steels; specialty high-temp stainless steels	0.35
9	Commercial yellow brasses and bronzes	0.40
10	High brasses and bronzes; naval brass; Muntz metal	0.45
11	18% Cr type corrosion resistant steels; common 300 series stainless steels	0.50
12		0.55
13	Chromium or tin plating; 12% Cr type corrosion resistant steels; most 400 series stainless steels, i.e., 410 and some cast stainless steels	0.60
14	Terneplate; tin-lead solder	0.65
15	Lead; high-lead alloys	0.70
16	Wrought 2000 series aluminum alloys	0.75
17		0.80
18	Wrought gray or malleable iron; plain carbon and low-alloy steels; armco iron; cold-rolled steel	0.85
19	Wrought aluminum alloys except 2000 series cast Al-Si alloys; 6000 series aluminum	0.90
20	Cast aluminum alloys other than Al-Si; cadmium plating	0.95
21		1.00
22		1.05
23		1.10
24		1.15
25	Hot-dip galvanized or electrogalvanized steel	1.20
26	Wrought zinc; zinc die casting alloys	1.25
27		1.30
28		1.35
29		1.40
30		1.45
31		1.50
32		1.55
33		1.60
34		1.65
35		1.70
36	Wrought and cast magnesium alloys	1.75
37		1.80
38	Beryllium	1.85



For harsh environments (presence of fair to good ionic conductors), all metals in contact with each other should be no more than one level of the chart apart to minimize corrosion. This is shown by the dark blue regions of the plating bar chart under specific platings. Outdoor applications, high humidity, and salt air fall into this category.

For normal environments (storage in warehouses or non-temperature/humidity-controlled environments, etc.), the difference between dissimilar metals should not exceed 0.25 volts (5 chart levels counting the origin). This is shown by the light blue regions of the chart under specific platings.



 For office environments (temperature and humidity controlled), 0.5 volts can be tolerated (10 chart levels counting the origin). This is shown by the black regions under specific platings. Caution should be maintained when deciding that your application is temperature and humidity controlled. Many devices intended for use in office environments are stored in warehouses for extended periods of time before and in between use.

These are general guidelines which apply under most circumstances, but corrosion is a very complex subject whose details could not possibly fit in this space. If you are not sure which metals are compatible, please feel free to contact Laird Technologies and talk to our corrosion experts.

Effective shielding solutions for a great variety of applications

Germany Rosenheim

Äußere Oberaustraße 22
83026 Rosenheim, Germany
Phone +49.8031.2460.0
Fax +49.8031.2460.50
mail@lairdtech.de

Berlin

Richard-Tauber-Damm 10
12277 Berlin, Germany
Phone +49.30.8 18 72.800
Fax +49.30.8 18 72.801

Scotland

2 Kelvin Park South
Kelvin South Business Park
East Kilbride, Scotland G75 ORH
Phone +44.1355.248248
Fax +44.1355.244344

France

13 -15 rue des Entrepreneurs
91560 Crosne, France
Phone +33.1.69.49.79.79
Fax +33.1.69.49.79.80

Laird
TECHNOLOGIES

www.lairdtech.com



X-ON Electronics

Largest Supplier of Electrical and Electronic Components

Click to view similar products for [EMI Gaskets, Sheets, Absorbers & Shielding](#) *category:*

Click to view products by [Laird Connectivity](#) *manufacturer:*

Other Similar products are found below :

[8101010140](#) [8563-0090-89](#) [1194-7.7X10](#) [1245-34"X18YD](#) [1267](#) [1345-3/8x18yrd](#) [1554907-1](#) [2320002000](#) [2320014700](#) [SG293037DS](#)
[ST005PCN50](#) [55005107](#) [38M4040AA0606](#) [46J5N02020.NN00](#) [1125-8X10](#) [1126X1"](#) [1170-3/4X18YDS](#) [1170-7.7x10](#) [1183-12"X18YD](#) [6-](#)
[34T-BD-0.315](#) [SG125187D-24](#) [SG125250R-24](#) [SG187375R-24](#) [SG284050DS](#) [8402010540](#) [KIT TECH CLIP](#) [10-40450-28S](#) [1245](#) [1267-](#)
[1/2"x18yd](#) [46J8501020.NN00](#) [1170-1/4"x18yd](#) [AL-36FR-1x54.5](#) [3013310A](#) [1194X1"](#) [3020604](#) [3021302](#) [3031313](#) [260709](#) [3021310](#) [6-](#)
[34UT-070-BD-16](#) [303076048](#) [46J5N03020.NN00](#) [30206025](#) [30395641](#) [3030403](#) [3690103020](#) [HNY-LT15CU4241](#) [46X7503020.NN00](#)
[46W5E02520.NN00](#) [302095032](#)