

ThermaTEC™ Series HT9-3-F2-2525

Thermoelectric Modules

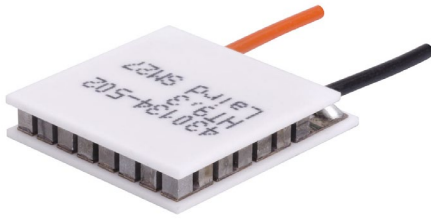

Note: This product has reached end of production and is available on a limited basis only. This product series has been replaced with the improved HiTemp ET Series product offering. Consider using ET9-3-F2-2525 HiTemp ET Series module as a replacement.

Americas: +1.919.597.7300
Europe: +46.31.420530
Asia: +86.755.2714.1166
ets.sales@lairdtech.com
www.lairdtech.com

The ThermaTEC™ Series of thermoelectric modules (TEMs) are designed to operate under cycling conditions or high temperature applications. This product line is available in multiple configurations and is ideal for applications that require both heating and cooling mode (reverse polarity) or power generation. Assembled with proprietary solder construction, Bismuth Telluride semiconductor material and thermally conductive Aluminum Oxide ceramics, the ThermaTEC Series is designed for higher current and larger heat-pumping applications.

FEATURES

- Thermal cycling durability
- Power cycling reliability
- Precise temperature control
- Strong lead attachment
- RoHS compliant
- Continuous operation at high temperatures

APPLICATIONS

- Analytical instrumentation
- PCR cyclers
- Thermal test sockets
- Electronic enclosure cooling
- Chillers (liquid cooling)
- Power generation

SPECIFICATIONS

TECHNICAL		
Hot Side Temperature (°C)	25°C	50°C
Qmax (Watts)	20.1	22.1
Delta Tmax (°C)	63	75
I _{max} (Amps)	9.6	9.6
V _{max} (Volts)	3.6	4.0
Module Resistance (Ohms)	0.34	0.38

SUFFIX	THICKNESS (PRIOR TO TINNING)	FLATNESS & PARALLELISM	HOT FACE	COLD FACE	LEAD LENGTH
11	0.197"±0.005"	0.002" /0.0035"	Lapped	Lapped	6.0"
TA	0.197"±0.001"	0.001"/0.001"	Lapped	Lapped	6.0"
TB	0.197"±0.0005"	0.0005"/0.0005"	Lapped	Lapped	6.0"

SEALING OPTIONS

SUFFIX	SEALANT	COLOR	TEMP RANGE	DESCRIPTION
RT	RTV	White	-60 to 204 °C	Non-corrosive, silicone adhesive
EP	Epoxy	Black	-55 to 150 °C	Low density syntactic foam epoxy encapsulant

Performance Curves at Th =25°C

THERMO

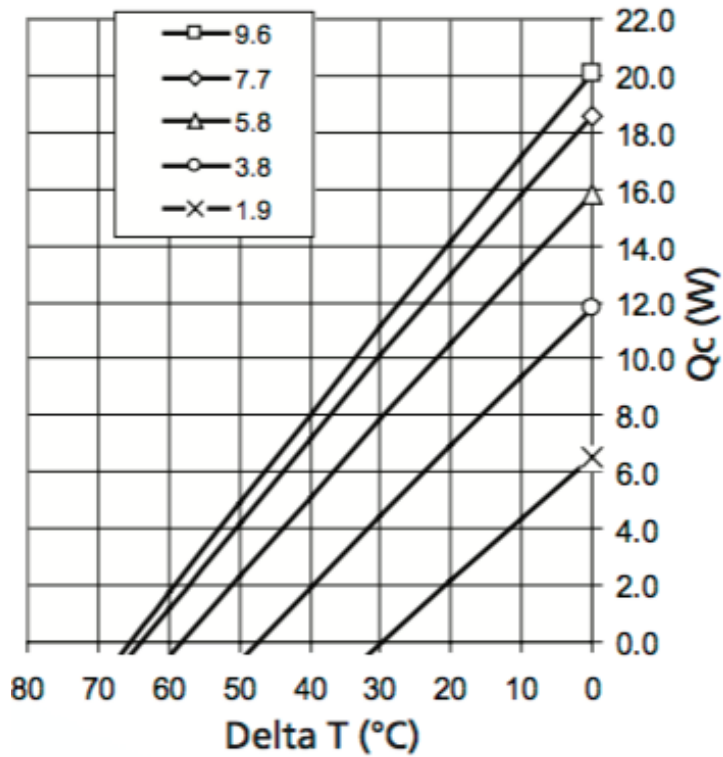

ELECTRIC

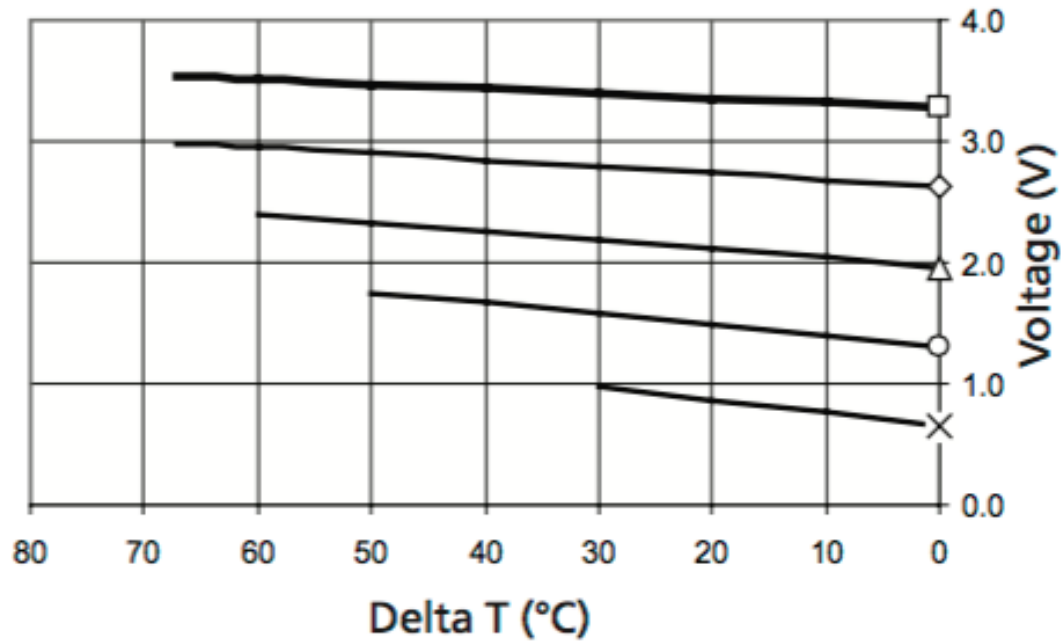

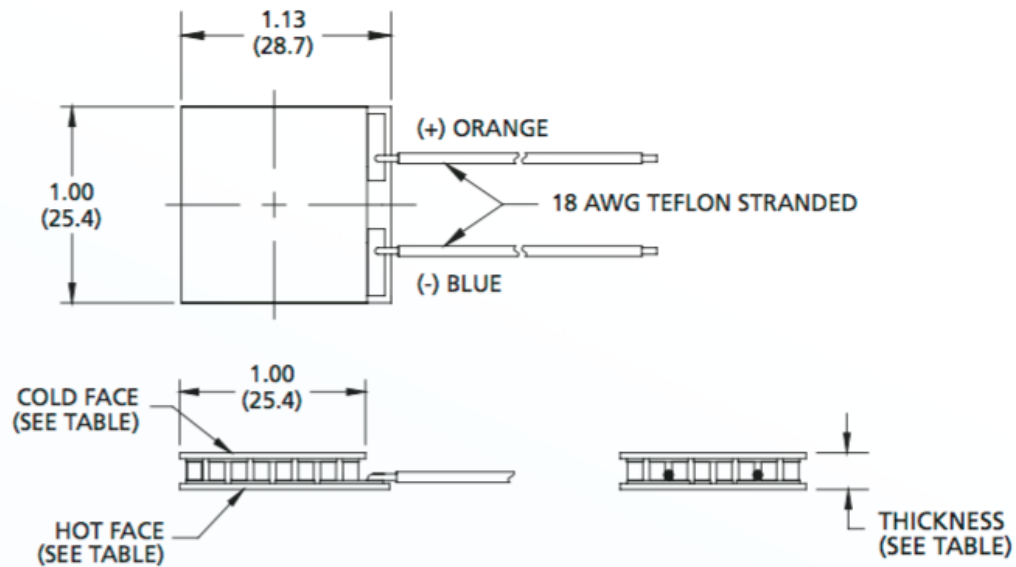

Ceramic Material: Alumina (Al_2O_3)
 Solder Construction: 271°C, Proprietary

NOTES

1. Max operating temperature: 175°C
2. Do not exceed I_{max} or V_{max} when operating module
3. Reference assembly guidelines for recommended installation

LAIRD-ETS-HT9-3-F2-2525-DATA-SHEET-101416

Any information furnished by Laird Technologies, Inc. and its agents is believed to be accurate and reliable. All specifications are subject to change without notice. Responsibility for the use and application of Laird Technologies materials rests with the end user. Laird Technologies makes no warranties as to the fitness, merchantability, suitability or non-infringement of any Laird Technologies materials or products for any specific or general uses. Laird Technologies shall not be liable for incidental or consequential damages of any kind. All Laird Technologies products are sold pursuant to the Laird Technologies' Terms and Conditions of sale in effect from time to time, a copy of which will be furnished upon request. © Copyright 2016 Laird Technologies, Inc. All Rights Reserved. Laird, Laird Technologies, the Laird Technologies Logo, and other marks are trademarks or registered trademarks of Laird Technologies, Inc. or an affiliate company thereof. Other product or service names may be the property of third parties. Nothing herein provides a license under any Laird Technologies or any third party intellectual property rights.

X-ON Electronics

Largest Supplier of Electrical and Electronic Components

Click to view similar products for [Thermoelectric Peltier Modules](#) category:

Click to view products by [Laird Connectivity](#) manufacturer:

Other Similar products are found below :

[C3100-1980](#) [C3200-0504](#) [C3200-0505](#) [C3200-371](#) [C3400-0262](#) [430084-505](#) [C3400-215](#) [430866-501](#) [CP39136H](#) [CP35447](#) [CP85204035](#)
[CP60131H](#) [CPM-2F](#) [CP853345H](#) [CP85138](#) [CP35347](#) [430077-523](#) [CP081030-M](#) [CP12437](#) [CP30138H](#) [CP30338](#) [CP303385H](#) [CP35247](#)
[CP39236H](#) [CP393365H](#) [CP40236](#) [CP40247](#) [CP40347](#) [CP50441](#) [CP60231H](#) [CP60233](#) [CP60239H](#) [CP60240](#) [CP60301540](#) [CP60333](#)
[CP603395H](#) [CP60340](#) [CP604395H](#) [CP60440](#) [CP70437](#) [CP854345H](#) [CP854705-2](#) [CP10205033](#) [CP10304033](#) [CP1054033H](#) [CP115035335](#)
[CP144745325](#) [CP200543636](#) [CP2020405H](#) [CP203475H](#)