

# Datasheet

## BL653 Series

*Version 0.1*

---

PRELIMINARY



## CONTENTS

1	Overview and Key Features.....	5
1.1	Features and Benefits .....	5
1.2	Application Areas .....	5
2	Specification.....	6
2.1	Specification Summary.....	6
3	Hardware Specifications .....	10
3.1	Block Diagram and Pin-out.....	10
3.2	Pin Definitions .....	11
3.3	Electrical Specifications.....	17
3.3.1	Absolute Maximum Ratings .....	17
3.3.2	Recommended Operating Parameters .....	18
3.4	Programmability .....	20
3.4.1	BL653 Special Function Pins in <i>smart</i> BASIC.....	20
4	Power Consumption.....	21
4.1	Power Consumption .....	21
4.2	Peripheral Block Current Consumption .....	23
5	Functional Description .....	24
5.1	Power Management .....	24
5.2	BL653 Power Supply Options.....	24
5.3	Clocks and Timers.....	26
5.3.1	Clocks.....	26
5.3.2	Timers.....	26
5.4	Radio Frequency (RF).....	26
5.5	NFC.....	27
5.5.1	Use Cases .....	27
5.5.2	NFC Antenna Coil Tuning Capacitors .....	27
5.6	UART Interface.....	28
5.7	USB interface .....	29
5.8	SPI Bus .....	29
5.9	I2C Interface.....	30
5.10	General Purpose I/O, ADC, PWM and FREQ .....	30
5.10.1	GPIO.....	30
5.10.2	ADC .....	30
5.10.3	PWM Signal Output on up to 16 SIO Pins .....	31
5.10.4	FREQ Signal Output on up to 16 SIO Pins .....	31
5.11	nRESET pin.....	31
5.12	Two-wire Interface JTAG.....	31
5.13	BL653 Wakeup.....	32
5.13.1	Waking Up BL653 from Host .....	32
5.14	Low Power Modes.....	32
5.15	Temperature Sensor .....	33
5.16	Security/Privacy.....	33
5.16.1	Random Number Generator .....	33
5.16.2	AES Encryption/Decryption.....	33
5.16.3	Readback Protection.....	33
5.16.4	Elliptic Curve Cryptography .....	33
5.17	Optional External 32.768 kHz crystal .....	33
5.18	453-00039 On-board PCB Antenna Characteristics.....	35
6	Hardware Integration Suggestions.....	36
6.1	Circuit.....	36
6.2	PCB Layout on Host PCB - General.....	38
6.3	PCB Layout on Host PCB for the 453-00039 .....	38
6.3.1	Antenna Keep-out on Host PCB .....	38
6.3.2	Antenna Keep-out and Proximity to Metal or Plastic.....	40
6.4	50-Ohms RF trace and RF match series 2nH RF inductor on host PCB for BL653 RF pad variant (453-00041).....	40
6.5	External Antenna Integration with 453-00041.....	43
7	Mechanical Details.....	44
7.1	BL653 Mechanical Details .....	44
7.2	Host PCB Land Pattern and Antenna Keep-out for the 453-00039 .....	45
8	Application Note for Surface Mount Modules.....	46

8.1	Introduction.....	46
8.2	Shipping .....	46
8.2.1	Tape and Reel Package Information.....	46
8.2.2	Carton Contents.....	47
8.2.3	Packaging Process .....	48
8.2.4	Labeling .....	48
8.3	Reflow Parameters .....	49
9	FCC and IC Regulatory Statements.....	51
9.1	Antenna Information .....	51
9.2	Power Exposure Information .....	51
9.3	OEM Responsibilities .....	52
9.4	Federal Communication Commission Interference Statement .....	52
9.5	Industry Canada Statement.....	54
10	Japan (MIC) Regulatory .....	56
10.1	Antenna Information .....	56
11	CE Regulatory.....	56
11.1	Antenna Information .....	56
11.2	EU Declarations of Conformity .....	57
12	Ordering Information .....	58
13	Bluetooth SIG Qualification .....	58
13.1	Overview .....	58
13.2	Qualification Steps When Referencing a Laird End Product Design .....	58
13.3	Qualification Steps When Deviating from a Laird End Product Design .....	59
14	Additional Assistance.....	60

## 1 OVERVIEW AND KEY FEATURES

Every BL653 Series module is designed to simplify OEMs enablement of Bluetooth Low Energy (BLE) v5.1 and Thread (802.15.4) to small, portable, power-conscious devices. The BL653 provides engineers with considerable design flexibility in both hardware and software programming capabilities. Based on the world-leading Nordic Semiconductor nRF52833 chipset, the BL653 modules provide ultra-low power consumption with outstanding wireless range via +8 dBm of transmit power and the Long Range (CODED PHY) Bluetooth 5 feature. The BL653 is programmable via Laird Connectivity's *smartBASIC* language, AT command set, Zephyr RTOS or Nordic's software development kit (SDK).

*smartBASIC* is an event-driven programming language that is highly optimized for memory-constrained systems such as embedded modules. It was designed to make BLE development quicker and simpler, vastly cutting down time to market.

The Nordic SDK, on the other hand, offers developers source code (in C) and precompiled libraries containing BLE and ANT+ device profiles, wireless communication, as well as application examples.



**Note:** BL653 hardware provides all functionality of the nRF52833 chipset used in the module design. This is a hardware datasheet only – it does not cover the software aspects of the BL653.

For customers using *smartBASIC*, refer to the *smartBASIC* extensions guide (available from the [BL653 product page](#) of the Laird Connectivity website). For customers using the Nordic SDK, refer to [www.nordicsemi.com](http://www.nordicsemi.com).

### 1.1 Features and Benefits

- Bluetooth v5.1 – Single mode
- NFC
- 802.15.4 (Thread) radio support
- External or internal antennas
- Multiple programming options
  - *smartBASIC*
  - AT command set
  - Nordic SDK in C
  - Zephyr RTOS
- Compact footprint
- Programmable Tx power +8 dBm to -20 dBm, -40 dBm
- Rx sensitivity -96 dBm (1 Mbps), -103 dBm (125 kbps)
- Ultra-low power consumption
- Tx – 4.9 mA peak (at 0 dBm, DCDC on)  
(See [Note 1](#) in the *Power Consumption* section)
- Rx: 4.6 mA peak (DCDC on)  
(See [Note 1](#) in the *Power Consumption* section)
- Standby Doze – 2.6 uA typical
- Deep Sleep – 0.6 uA – (See [Note 4](#) in the *Power Consumption* section)
- UART, GPIO, ADC, PWM, FREQ output, timers, I2C, SPI, I2S, PDM, and USB interfaces
- Fast time-to-market
- FCC, CE, IC, RCM, Japan, and KC certified
- Full Bluetooth Declaration ID
- Other regulatory certifications on request
- No external components required
- Extended Industrial temperature range (-40° C to +105° C)

### 1.2 Application Areas

- Medical devices
- IoT Sensors
- Accessories
- Fitness sensors
- Location awareness
- Home automation

## 2 SPECIFICATION

### 2.1 Specification Summary

Categories/Feature	Implementation
<b>Wireless Specification</b>	
Bluetooth®	<ul style="list-style-type: none"> <li>▪ BT 5.1 – Single mode</li> <li>▪ Angle-of-arrival (AoA) and angle-of-departure (AoD) – BT 5.1</li> <li>▪ 4x Range (CODED PHY support) – BT 5.0</li> <li>▪ 2x Speed (2M PHY support) – BT 5.0</li> <li>▪ LE Advertising Extensions – BT 5.0</li> <li>▪ Concurrent master, slave</li> <li>▪ BLE Mesh capabilities</li> <li>▪ Diffie-Hellman based pairing (LE Secure Connections) – BT 4.2</li> <li>▪ Data Packet Length Extension – BT 4.2</li> <li>▪ Link Layer Privacy (LE Privacy 1.2) – BT 4.2</li> <li>▪ LE Dual Mode Topology – BT 4.1</li> <li>▪ LE Ping – BT 4.1</li> </ul>
Frequency	2.402 - 2.480 GHz
Raw Data Rates	1 Mbps BLE (over-the-air) 2 Mbps BLE (over-the-air) 125 kbps BLE (over-the-air) 500 kbps BLE (over-the-air)
Maximum Transmit Power Setting	+8 dBm   Conducted 453-00039 (Integrated antenna)
	+8 dBm   Conducted 453-00041 (Trace pin–connecting to External antenna)
Minimum Transmit Power Setting	-40 dBm, -20 dBm (in 4 dB steps)
	-16 dBm, -12 dBm, - 8 dBm, - 4 dBm, 0 dBm, 2 dBm, 4 dBm, 5 dBm, 6 dBm, 7 dBm,
Receive Sensitivity (≤ 37-byte packet)	BLE 1 Mbps (BER=1E-3)    -96 dBm typical
	BLE 2 Mbps                    -92 dBm typical
	BLE 125 kbps                -103 dBm typical
	BLE 500 kbps                -99 dBm typical
Link Budget (conducted)	104 dB                    @ BLE 1 Mbps
	111 dB                    @ BLE 125 kbps

Categories/Feature	Implementation
<b>NFC</b>	
NFC-A Listen mode compliant	<p><b>Based on NFC forum specification</b></p> <ul style="list-style-type: none"> <li>13.56 MHz</li> <li>Date rate 106 kbps</li> <li>NFC Type 2 and Type 4 emulation</li> </ul> <p><b>Modes of Operation:</b></p> <ul style="list-style-type: none"> <li>Disable</li> <li>Sense</li> <li>Activated</li> </ul> <p><b>Use Cases:</b></p> <ul style="list-style-type: none"> <li>Touch-to-Pair with NFC</li> <li>NFC enabled Out-of-Band Pairing</li> </ul>
System Wake-On-Field function	Proximity Detection
<b>Host Interfaces and Peripherals</b>	
Total	42 x multifunction I/O lines
UART	<p>2 UARTs</p> <p>Tx, Rx, CTS, RTS</p> <p>DCD, RI, DTR, DSR (See <a href="#">Note 1</a> in the Module Specification Notes)</p> <p>Default 115200, n, 8, 1</p> <p>From 1,200 bps to 1 Mbps</p>
USB	<p>USB 2.0 FS (Full Speed, 12 Mbps).</p> <p>CDC driver/Virtual UART (baud rate TBD)</p> <p>Other USB drivers available via Nordic SDK</p>
GPIO	<p>Up to 42, with configurable:</p> <ul style="list-style-type: none"> <li>I/O direction</li> <li>O/P drive strength (standard 0.5 mA or high 3mA/5 mA)</li> <li>Pull-up /pull-down</li> <li>Input buffer disconnect</li> </ul>
ADC	<p>Eight 8/10/12-bit channels</p> <p>0.6 V internal reference</p> <p>Configurable 4, 2, 1, 1/2, 1/3, 1/4, 1/5 1/6 (default) pre-scaling</p> <p>Configurable acquisition time 3uS, 5uS, 10uS (default), 15uS, 20uS, 40uS.</p> <p>One-shot mode</p>
PWM Output	<p>PWM outputs on 16 GPIO output pins</p> <ul style="list-style-type: none"> <li>PWM output duty cycle: 0%-100%</li> <li>PWM output frequency: Up to 500 kHz</li> </ul>
FREQ Output	<p>FREQ outputs on 16 GPIO output pins</p> <ul style="list-style-type: none"> <li>FREQ output frequency: 0 MHz-4 MHz (50% duty cycle)</li> </ul>
I2C	Two I2C interface (up to 400 kbps) – See <a href="#">Note 2</a> in the Module Specification Notes
SPI	Four SPI Master Slave interface (up to 4 Mbps)
Temperature Sensor	<ul style="list-style-type: none"> <li>One temperature sensor</li> <li>Temperature range equal to the operating temperature range</li> <li>Resolution 0.25 degrees</li> </ul>

Categories/Feature	Implementation
RSSI Detector	<ul style="list-style-type: none"> <li>One RF received signal strength indicator</li> <li>±2 dB accuracy (valid over -90 to -20 dBm)</li> <li>One dB resolution</li> </ul>
I2S	One inter-IC sound interface
PDM	One pulse density modulation interface
<b>Optional (External to the BL653 module)</b>	
External 32.768 kHz crystal	For customer use, connect +/-20 ppm accuracy crystal for more accurate protocol timing.
<b>Profiles</b>	
Supported Services	<ul style="list-style-type: none"> <li>Central mode</li> <li>Peripheral mode</li> <li>Mesh (with custom models)</li> <li>Custom and adopted profiles</li> </ul>
<b>Programmability</b>	
<i>smart</i> BASIC	<ul style="list-style-type: none"> <li>FW upgrade via JTAG or UART</li> <li>Application download via UART or Via Over-the-Air (if SIO_02 pin is pulled high externally)</li> </ul>
Nordic SDK	Via JTAG
<b>Operating Modes</b>	
<i>smart</i> BASIC	<p><b>Self-contained Run mode</b> Selected by nAutoRun pin status: LOW (0V). Then runs \$autorun\$ (<i>smart</i>BASIC application script) if it exists.</p> <p><b>Interactive/Development mode</b> HIGH (VDD). Then runs via at+run (and <i>file name</i> of <i>smart</i>BASIC application script).</p>
AT Command set	Comprehensive Hayes-style AT command set
Nordic SDK	As per Nordic SDK
Zephyr RTOS	As per <a href="http://www.zephyrproject.org">www.zephyrproject.org</a>
<b>Supply Voltage</b>	
Supply (VDD or VDD_HV) options	<ul style="list-style-type: none"> <li>Normal voltage mode VDD 1.7- 3.6 V – Internal DCDC converter or LDO (See <a href="#">Note 3</a> in the Module Specification Notes)</li> <li>OR</li> <li>High voltage mode VDD_HV 2.5V-5.5V Internal LDO (See <a href="#">Note 3</a> and <a href="#">Note 4</a> in the Module Specification Notes)</li> </ul>
<b>Power Consumption</b>	
Active Modes Peak Current (for maximum Tx power +8 dBm) – Radio only	14.2 mA peak Tx (with DCDC)
Active Modes Peak Current (for Tx power -40 dBm) – Radio only	2.3 mA peak Tx (with DCDC)
Active Modes Average Current	Depends on many factors, see <a href="#">Power Consumption</a>
Ultra-low Power Modes	Standby Doze      2.6 uA typical
	Deep Sleep        0.6 uA



Categories/Feature	Implementation
<b>Antenna Options</b>	
Internal	Printed PCB monopole antenna – on-board <b>453-00039 variant</b>
External	<ul style="list-style-type: none"> <li>▪ Dipole antenna (with IPEX connector)</li> <li>▪ Dipole PCB antenna (with IPEX connector)</li> <li>▪ Connection via RF connector (IPEX MH4) – <b>453-00041 variant (RF trace pin)</b></li> </ul> See the Antenna Information sections for <a href="#">FCC and IC</a> , <a href="#">MIC</a> , <a href="#">RCM</a> , <a href="#">KC</a> and <a href="#">CE</a> .
<b>Physical</b>	
Dimensions	15.0 mm x 10 mm x 2.2 mm Pad Pitch – 0.8 mm Pad Type – Two rows of pads
Weight	<1 gram
<b>Environmental</b>	
Operating	-40 °C to +105 °C
Storage	-40 °C to +85 °C
<b>Miscellaneous</b>	
Lead Free	Lead-free and RoHS-compliant
Warranty	One-year warranty
<b>Development Tools</b>	
Development Kit	Development kit per module SKU (453-00039-K1 and 453-00041-K1) and free software tools
<b>Approvals</b>	
Bluetooth®	Full Bluetooth SIG Declaration ID
FCC/IC/CE/MIC/RCM/KC	All BL653 Series

**Module Specification Notes:**

<b>Note 1</b>	DSR, DTR, RI, and DCD can be implemented in the <i>smart</i> BASIC application or through the Nordic SDK.
<b>Note 2</b>	With I2C interface selected, pull-up resistors on I2C SDA and I2C SCL <b>must</b> be connected externally as per I2C standard.
<b>Note 3</b>	Use of the internal DCDC (REG1) convertor or LDO (REG1) is decided by the underlying BLE stack.
<b>Note 4</b>	In High Voltage mode (VDD_HV), no external current draw (from VDD pin) is allowed (limitation of nRF52833 chipset).

### 3 HARDWARE SPECIFICATIONS

#### 3.1 Block Diagram and Pin-out

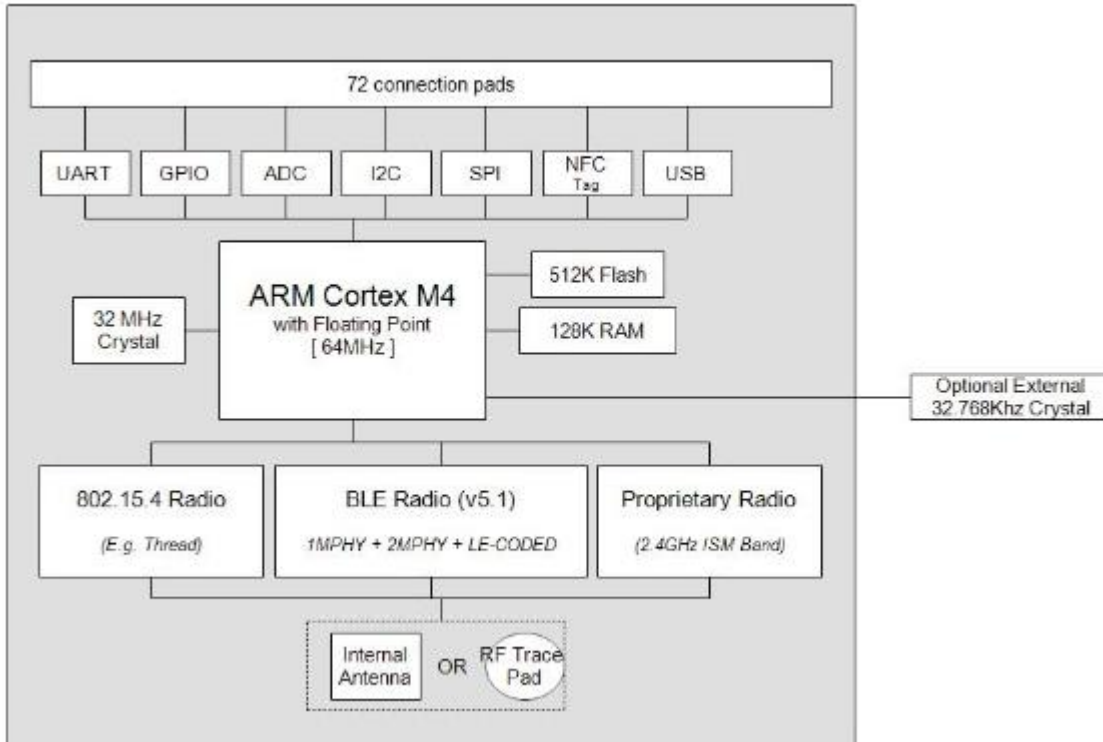

Figure 1: BL653 block diagram

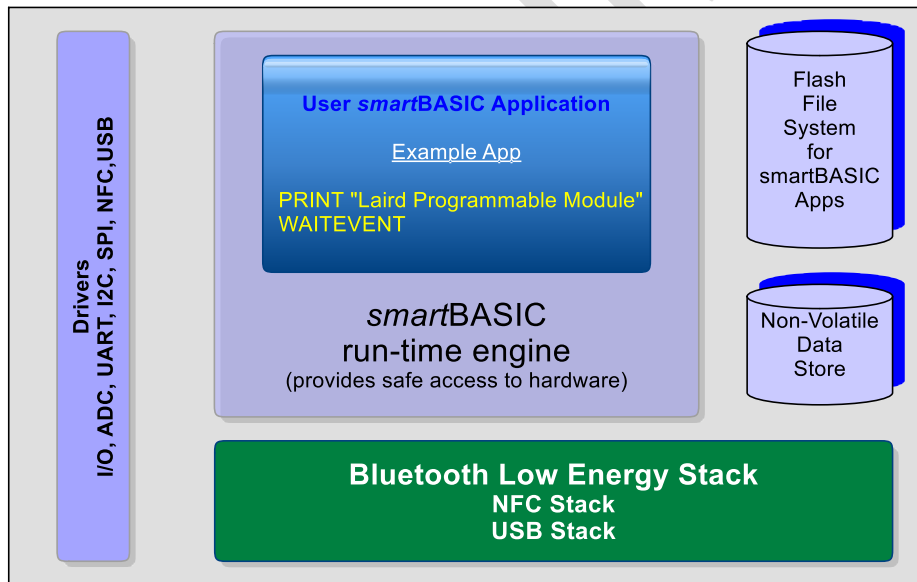

Figure 2: Functional HW and SW block diagram for BL653 series BLE module

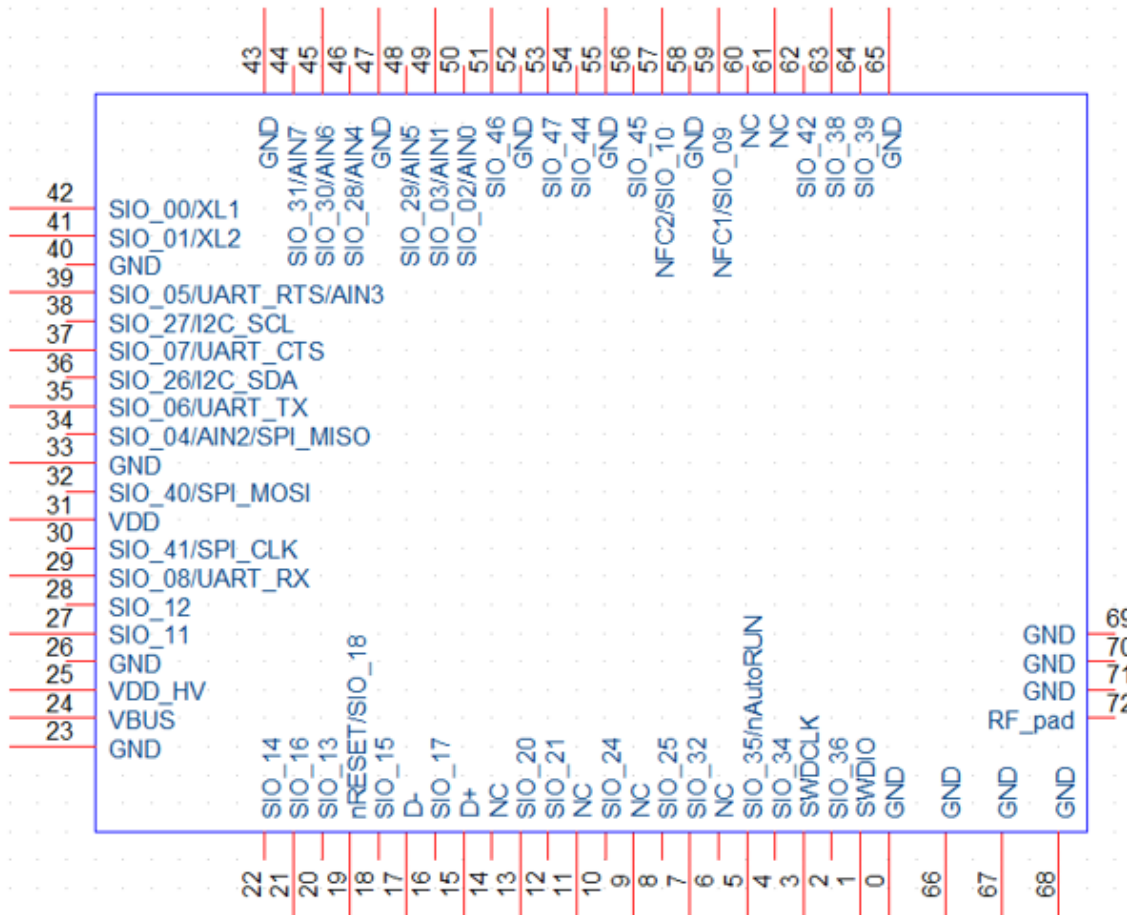

Figure 3: BL653 module pin-out (top view). Outer row pads (long red line) and inner row pads (short red line) shown.

### 3.2 Pin Definitions

Table 1: Pin definitions

Pin #	Pin Name	Default Function	Alternate Function	In/ Out	Pull-Up/ Down	nRF52833 QFN Pin	nRF52833 QFN Name	Comment
0	GND	-	-	-	-	-	-	-
1	SWDIO	SWDIO	-	In	Pull-up	AC24	SWDIO	-
2	SIO_36	SIO_36	-	In	Pull-up	U24	P1.04	-
3	SWDCLK	SWDCLK	-	In	Pull-down	AA24	SWDCLK	-
4	SIO_34	SIO_34	-	-	Pull-up	W24	P1.02	-
5	SIO_35/ nAutoRUN	nAutoRUN	SIO_35	In	Pull-down	Y23	P1.01	<b>Laird Connectivity Devkit:</b> FTDI USB_DTR via jumper on J12 pin 1-2
6	NC	-	-	-	-	-	-	-
7	SIO_32	SIO_32	-	In	Pull-up	AD22	P1.00/ TRACEDATA0	-

Pin #	Pin Name	Default Function	Alternate Function	In/ Out	Pull-Up/ Down	nRF52833 QFN Pin	nRF52833 QFN Name	Comment
8	SIO_25	SIO_25	-	In	Pull-up	AD18	P0.22	<b>Laird Devkit:</b> BUTTON1
9	NC	-	-	-	-	-	-	-
10	SIO_24	SIO_24	-	In	Pull-up	AD20	P0.24	<b>Laird Connectivity Devkit:</b> BUTTON3
11	NC	-	-	-	-	-	-	-
12	SIO_21	SIO_21	-	In	Pull-up	AC17	P0.21	-
13	SIO_20	SIO_20	-	In	Pull-up	AD16	P0.20	-
14	NC	-	-	-	-	-	-	-
15	D+	D+	-	In	-	AD6	D+	-
16	SIO_17	SIO_17	-	In	Pull-up	AD12	P0.17	-
17	D-	D-	-	In	-	AD4	D-	-
18	SIO_15	SIO_15	-	In	Pull-up	AD10	P0.15	<b>Laird Connectivity Devkit:</b> LED3
19	nRESET	nRESET	SIO_18	In	Pull-up	AC13	P0.18/ nRESET	System Reset (Active Low)
20	SIO_13	SIO_13	-	In	Pull-up	AD8	P0.13	<b>Laird Connectivity Devkit:</b> LED1
21	SIO_16	SIO_16	-	In	Pull-up	AC11	P0.16	<b>Laird Connectivity Devkit:</b> LED4
22	SIO_14	SIO_14	-	In	Pull-up	AC9	P0.14	<b>Laird Connectivity Devkit:</b> LED2
23	GND	-	-	-	-	-	-	-
24	VBUS	-	-	-	-	AD2	VBUS	4.35V – 5.5V
25	VDD_HV	-	-	-	-	Y2	VDDH	2.5V to 5.5V
26	GND	-	-	-	-	-	-	-
27	SIO_11	SIO_11	-	In	Pull-up	T2	P0.11/ TRACEDATA2	<b>Laird Connectivity Devkit:</b> BUTTON1
28	SIO_12	SIO_12	-	In	Pull-up	U1	P0.12/ TRACEDATA1	-
29	SIO_08/ UART_RX	SIO_08	UART_RX	In	Pull-up	N1	P0.08	UARTCLOSE() selects DIO functionality UARTOPEN() selects UART COMMS behavior

Pin #	Pin Name	Default Function	Alternate Function	In/ Out	Pull-Up/ Down	nRF52833 QFN Pin	nRF52833 QFN Name	Comment
30	SIO_41/ SPI_CLK	SIO_41	SPI_CLK	In	Pull-up	R1	P1.09/ TRACEDATA3	<b>Laird Connectivity Devkit:</b> SPI EEPROM. SPI_Eeprom_CLK, Output: SPIOPEN() in <i>smartBASIC</i> selects SPI function, MOSI and CLK are outputs when in SPI master mode.
31	VDD	-	-	-	-	AD14	VDD	1.7V to 3.6V
32	SIO_40/ SPI_MOSI	SIO_40	SPI_MOSI	In	Pull-up	P2	P1.08	<b>Laird Connectivity Devkit:</b> SPI EEPROM. SPI_Eeprom_MOSI, Output SPIOPEN() in <i>smartBASIC</i> selects SPI function, MOSI and CLK are outputs in SPI master.
33	GND	-	-	-	-	-	-	-
34	SIO_04/ AIN2/ SPI_MISO	SIO_04	AIN2/ SPI_MISO	In	Pull-up	J1	P0.04/AIN2	<b>Laird Connectivity Devkit:</b> SPI EEPROM. SPI_Eeprom_MISO, Input SPIOPEN() in <i>smartBASIC</i> selects SPI function; MOSI and CLK are outputs when in SPI master mode
35	SIO_06/ UART_TX	SIO_06	UART_TX	Out	Set High in FW	L1	P0.06	UARTCLOSE() selects DIO functionality UARTOPEN() selects UART COMMS behaviour
36	SIO_26/ I2C_SDA	SIO_26	I2C_SDA	In	Pull-up	G1	P0.26	<b>Laird Connectivity Devkit:</b> I2C RTC chip I2C data line
37	SIO_07/ UART_CTS	SIO_07	UART_CTS	IN	Pull-down	M2	P0.07/ TRACECLK	UARTCLOSE() selects DIO functionality UARTOPEN() selects UART COMMS behaviour

Pin #	Pin Name	Default Function	Alternate Function	In/ Out	Pull-Up/ Down	nRF52833 QFN Pin	nRF52833 QFN Name	Comment
38	SIO_27/ I2C_SCL	SIO_27	I2C_SCL	In	Pull-up	H2	P0.27	<b>Laird Connectivity Devkit:</b> I2C RTC chip I2C clock line
39	SIO_05/ UART_RTS/ AIN3	SIO_05	UART_RTS/ AIN3	Out	Set Low in FW	K2	P0.05/AIN3	UARTCLOSE() selects DIO functionality UARTOPEN() selects UART COMMS behavior
40	GND	-	-	-	-	-	-	-
41	SIO_01/ XL2	SIO_01	XL2	In	Pull-up	F2	P0.01/XL2	<b>Laird Connectivity Devkit:</b> Optional 32.768kHz crystal pad XL2 and associated load capacitor
42	SIO_00/ XL1	SIO_00	XL1	In	Pull-up	D2	P0.00/XL1	<b>Laird Connectivity Devkit:</b> Optional 32.768kHz crystal pad XL1 and associated load capacitor
43	GND	-	-	-	-	-	-	-
44	SIO_31/ AIN7	SIO_31	AIN7	In	Pull-up	A8	P0.31/AIN7	-
45	SIO_30/ AIN6	SIO_30	AIN6	In	Pull-up	B9	P0.30/AIN6	-
46	SIO_28/ AIN4	SIO_28	AIN4	In	Pull-up	B11	P0.28/AIN4	-
47	GND	-	-	-	-	-	-	-
48	SIO_29/ AIN5	SIO_29	AIN5	In	Pull-up	A10	P0.29/AIN5	-
49	SIO_03/ AIN1	SIO_03	AIN1	In	Pull-up	B13	P0.03/AIN1	<b>Laird Connectivity Devkit:</b> Temp Sens Analog
50	SIO_02/ AIN0	SIO_02	AIN0	IN	Pull-down	A12	P0.02/AIN0	Pull High externally to enter VSP (Virtual Serial Port) Service.
51	SIO_46	SIO_46	-	In	Pull-up	B15	P1.03	-
52	GND	-	-	-	-	-	-	-
53	SIO_47	SIO_47	-	In	Pull-up	A14	P0.19	-

Pin #	Pin Name	Default Function	Alternate Function	In/ Out	Pull-Up/ Down	nRF52833 QFN Pin	nRF52833 QFN Name	Comment
54	SIO_44	SIO_44	-	In	Pull-up	B17	P0.23	Laird Connectivity Devkit: SPI EEPROM SPI_Eeprom_CS, Input
55	GND	-	-	-	-	-	-	-
56	SIO_45	SIO_45	-	In	Pull-up	A16	P1.05	-
57	NFC2/ SIO_10	NFC2	SIO_10	In	-	J24	P0.10/NFC2	-
58	GND	-	-	-	-	-	-	-
59	NFC1/ SIO_09	NFC1	SIO_09	In	-	L24	P0.09/NFC1	-
60	NC	-	-	-	-	-	-	-
61	NC	-	-	-	-	-	-	-
62	SIO_42	SIO_42	-	In	Pull-up	A20	P0.25	-
63	SIO_38	N/C	-	In	Pull-up	R24	P1.06	Reserved for future use. Do not connect.
64	SIO_39	SIO_39	-	In	Pull-up	P23	P1.07	-
65	GND	-	-	-	-	-	-	-
66	GND	-	-	-	-	-	-	-
67	GND	-	-	-	-	-	-	-
68	GND	-	-	-	-	-	-	-
69	GND	-	-	-	-	-	-	-
70	GND	-	-	-	-	-	-	-
71	GND	-	-	-	-	-	-	-
72	RF pad	-	-	-	-	-	-	Used on BL653 RF pad variant (453-00041). Note11

**Pin Definition Notes:**

- Note 1** SIO = Signal Input or Output. Secondary function is selectable in *smartBASIC* application or via Nordic SDK. I/O voltage level tracks VDD. AIN = Analog Input.
- Note 2** At reset, all SIO lines are configured as the defaults shown above. SIO lines can be configured through the *smartBASIC* application script to be either inputs or outputs with pull-ups or pull-downs. When an alternative SIO function is selected (such as I2C or SPI), the firmware does not allow the setup of internal pull-up/pull-down. Therefore, when I2C interface is selected, pull-up resistors on I2C SDA and I2C SCL **must** be connected externally as per I2C standard.
- Note 3** JTAG (two-wire SWD interface), pin 1 (SWDIO) and pin 3 (SWDCLK). JTAG is required because Nordic SDK applications can only be loaded using JTAG (*smartBASIC* firmware can be loaded using the JTAG as well as UART). We recommend that you use JTAG (2-wire interface) to handle future BL653 module *smartBASIC* firmware upgrades. You **MUST** wire out the JTAG (2-wire interface) on your host design (see [Figure 7](#), where four lines (SWDIO, SWDCLK, GND and VDD) should be wired out. *smartBASIC*

**Pin Definition Notes:**

	<p>firmware upgrades can still be performed over the BL653 UART interface, but this is slower (60 seconds using UART vs. 10 seconds when using JTAG) than using the BL653 JTAG (2-wire interface).</p> <p>Upgrading <i>smartBASIC</i> firmware or loading the <i>smartBASIC</i> applications is done using the UART interface.</p>
<b>Note 4</b>	<p>Pull the nRESET pin (pin 19) low for minimum 100 milliseconds to reset the BL653.</p>
<b>Note 5</b>	<p>The SIO_02 pin (pin 50) must be pulled high externally to enable VSP (Virtual Serial Port) which would allow OTA (over-the-air) <i>smartBASIC</i> application download. Refer to the latest firmware release documentation for details.</p>
<b>Note 6</b>	<p>Ensure that SIO_02 (pin 50) and AutoRUN (pin 5) are <b>not both high</b> (externally), in that state, the UART is bridged to Virtual Serial Port service; the BL653 module does not respond to AT commands and cannot load <i>smartBASIC</i> application scripts.</p>
<b>Note 7</b>	<p>Pin 5 (nAutoRUN) is an input, with active low logic. In the development kit it is connected so that the state is driven by the host's DTR output line. The nAutoRUN pin must be externally held high or low to select between the following two BL653 operating modes:</p> <ul style="list-style-type: none"> <li>▪ Self-contained Run mode (nAutoRUN pin held at 0V –this is the default (internal pull-down enabled))</li> <li>▪ Interactive/Development mode (nAutoRUN pin held at VDD)</li> </ul> <p>The <i>smartBASIC</i> firmware checks for the status of nAutoRUN during power-up or reset. If it is low and if there is a <i>smartBASIC</i> application script named <b>\$autorun\$</b>, then the <i>smartBASIC</i> firmware executes the application script automatically; hence the name <i>Self-contained Run Mode</i>.</p>
<b>Note 8</b>	<p>The <i>smartBASIC</i> firmware has SIO pins as Digital (Default Function) INPUT pins, which are set PULL-UP by default. This avoids floating inputs (which can cause current consumption to drive with time in low power modes (such as Standby Doze). You can disable the PULL-UP through your <i>smartBASIC</i> application.</p> <p>All of the SIO pins (with a default function of DIO) are inputs (apart from SIO_05 and SIO_06, which are outputs):</p> <ul style="list-style-type: none"> <li>▪ SIO_06 (alternative function UART_TX) is an output, set High (in the firmware).</li> <li>▪ SIO_05 (alternative function UART_RTS) is an output, set Low (in the firmware).</li> <li>▪ SIO_08 (alternative function UART_RX) is an input, set with internal pull-up (in the firmware).</li> <li>▪ SIO_07 (alternative function UART_CTS) is an input, set with internal pull-down (in the firmware).</li> <li>▪ SIO_02 is an input set with internal pull-down (in the firmware). It is used for OTA downloading of <i>smartBASIC</i> applications. Refer to the latest firmware extension documentation for details.</li> <li>▪ UART_RX, UART_TX, and UART_CTS are 3.3 V level logic (if VDD is 3.3 V; such as SIO pin I/O levels track VDD). For example, when Rx and Tx are idle, they sit at 3.3 V (if VDD is 3.3 V). Conversely, handshaking pins CTS and RTS at 0V are treated as assertions.</li> </ul>
<b>Note 9</b>	<p>BL653 also allows as an option to connect an external higher accuracy (<math>\pm 20</math> ppm) 32.768 kHz crystal to the BL653 pins SIO_01/XL2 (pin 41) and SIO_00/XL1 (pin 42). This provides higher accuracy protocol timing and helps with radio power consumption in the system standby doze/deep sleep modes by reducing the time that the Rx window must be open.</p>
<b>Note 10</b>	<p>Not required for BL653 module normal operation. The on-chip 32.768kHz LFRC oscillator provides the standard accuracy of <math>\pm 500</math> ppm, with calibration required every 8seconds (default) to stay within <math>\pm 500</math> ppm.</p> <p>BL653 power supply options:</p> <ul style="list-style-type: none"> <li>▪ <b>Option 1</b> – Normal voltage power supply mode entered when the external supply voltage is connected to both the VDD and VDD_HV pins (so that VDD equals VDD_HV). Connect external supply within range 1.7V to 3.6V range to BL653 VDD and VDD_HV pins.</li> </ul> <p style="text-align: center;">OR</p> <ul style="list-style-type: none"> <li>▪ <b>Option 2</b> – High voltage mode power supply mode (using BL653 VDD_HV pin) entered when the external supply voltage is ONLY connected to the VDDH pin and the VDD pin is not connected to any external voltage supply. Connect external supply within range 2.5V to 5.5V range to BL653 VDD_HV pin. BL653 VDD pin left unconnected.</li> </ul> <p>No external current draw (from VDD pin) is allowed when using High Voltage mode (VDD_HV) (limitation of nRF52833 chipset).</p>



**Pin Definition Notes:**

	For either option, if you use USB interface then the BL653 VBUS pin must be connected to external supply within the range 4.35V to 5.5V. When using the BL653 VBUS pin, you MUST externally fit a 4.7uF to ground.
<b>Note 11</b>	RF_pad (pin72) is for the BL653 RF pad variant (453-00041) module only. If using the BL653 module RF pad variant (453-00041), customer MUST copy the 50-Ohms GCPW RF track design, MUST add series 2nH RF inductor (Murata LQG15HN2N0B02# or Murata LQG15HS2N0B02) and RF connector IPEX MHF4 Receptacle (MPN: 20449-001E) Detailed in the following section: <b>50-Ohms RF Trace and RF Match Series 2nH RF Inductor on Host PCB for BL653 RF Pad Variant (453-00041).</b>

### 3.3 Electrical Specifications

#### 3.3.1 Absolute Maximum Ratings

Absolute maximum ratings for supply voltage and voltages on digital and analogue pins of the module are listed in the following table; exceeding these values causes permanent damage.

**Table 2: Maximum current ratings**

Parameter	Min	Max	Unit
Voltage at VDD pin	-0.3	+3.9 (Note 1)	V
Voltage at VDD_HV pin	-0.3	+5.8	V
VBUS	-0.3	+5.8	V
Voltage at GND pin		0	V
Voltage at SIO pin (at VDD ≤ 3.6V)	-0.3	VDD +0.3	V
Voltage at SIO pin (at VDD ≥ 3.6V)	-0.3	3.9	V
NFC antenna pin current (NFC1/2)	-	80	mA
Radio RF input level	-	10	dBm
<b>Environmental</b>			
Storage temperature	-40	+85	°C
MSL (Moisture Sensitivity Level)	-	4	-
ESD (as per EN301-489)			
Conductive		4	KV
Air Coupling		8	KV
Flash Memory (Endurance) (Note 2)	-	10000	Write/erase cycles
Flash Memory (Retention) at 85 °C	10	-	years
Flash Memory (Retention) at 105 °C (Limited to 1000 write /read cycles)	3		years
Flash Memory (Retention) at 105 °C to 85 °C, execution split (Limited to 1000 write /read cycles, 75% execution time at 85 °C or less)	6.7		years
Thermal characteristics (Junction temperature)		110	°C

**Maximum Ratings Notes:**

<b>Note 1</b>	The absolute maximum rating for VDD_nRF pin (max) is 3.9V for the BL653.
<b>Note 2</b>	Wear levelling is used in file system.

### 3.3.2 Recommended Operating Parameters

**Table 3: Power supply operating parameters**

Parameter	Min	Typ	Max	Unit
VDD (independent of DCDC enable) <sup>1,4</sup> supply range	1.7	3.3	3.6	V
VDD <sub>POR</sub> supply voltage needed during power on reset	1.75			V
VDD_HV supply range <sup>4</sup>	2.5	3.7	5.5	V
VBUS USB supply range	4.35	5	5.5	V
VDD Maximum ripple or noise <sup>2</sup>	-	-	10	mV
VDD supply rise time (0V to 1.7V) <sup>3</sup>	-	-	60	mS
VDD_HV supply rise time (0V to 3.7V) <sup>3</sup>			100	mS
Operating temperature range	-40	-	+85	°C
Extended operating temperature range <sup>5</sup>	+85		+105	°C

**Recommended Operating Parameters Notes:**

<b>Note 1</b>	4.7 uF internal to module on VDD. The VDD internal DCDC (REG1) convertor or LDO (REG1) is decided by the underlying BLE stack depending on the load current. Through a smartBASIC command can also tell softdevice to use DCDC always or LDO always.
<b>Note 2</b>	This is the maximum VDD or VDD_HV ripple or noise (at any frequency) that does not disturb the radio.
<b>Note 3</b>	The on-board power-on reset circuitry may not function properly for rise times longer than the specified maximum.
<b>Note 4</b>	<p>BL653 power supply options:</p> <ul style="list-style-type: none"> <li>▪ <b>Option 1</b> – Normal voltage power supply mode entered when the external supply voltage is connected to both the VDD and VDD_HV pins (so that VDD equals VDD_HV). Connect external supply within range 1.7V to 3.6V range to BL653 VDD and VDD_HV pins.</li> </ul> <p>OR</p> <ul style="list-style-type: none"> <li>▪ <b>Option 2</b> – High voltage mode power supply mode (using BL653 VDD_HV pin) entered when the external supply voltage is ONLY connected to the VDD_HV pin and the VDD pin is not connected to any external voltage supply. Connect external supply within range 2.5V to 5.5V range to BL653 VDD_HV pin. BL653 VDD pin left unconnected.</li> </ul> <p>No external current draw (from VDD pin) is allowed when using High Voltage mode (VDD_HV), limitation of the nRF52833 chip.</p> <p>For either option, if you use USB interface then the BL653 VBUS pin must be connected to external supply within the range 4.35V to 5.5V. When using the BL653 VBUS pin, you MUST externally fit a 4.7uF to ground.</p>
<b>Note 5</b>	To avoid surpassing the maximum die temperature (110 °C), it is important to minimize current consumption when operating in the extended operating temperature conditions (+85 °C to +105°C). It is therefore recommended to use the module device on Normal Voltage mode with DCDC (REG1) enabled.

**Table 4: Signal levels for interface, SIO**

Parameter	Min	Typ	Max	Unit
V <sub>IH</sub> Input high voltage	0.7 VDD		VDD	V
V <sub>IL</sub> Input low voltage	VSS		0.3 x VDD	V
V <sub>OH</sub> Output high voltage				
(std. drive, 0.5mA) (Note 1)	VDD -0.4		VDD	V
(high-drive, 3mA) (Note 1)	VDD -0.4		VDD	V
(high-drive, 5mA) (Note 2)	VDD -0.4		VDD	V
V <sub>OL</sub> Output low voltage				

Parameter	Min	Typ	Max	Unit
(std. drive, 0.5mA) (Note 1)	VSS		VSS+0.4	V
(high-drive, 3mA) (Note 1)	VSS		VSS+0.4	V
(high-drive, 5mA) (Note 2)	VSS		VSS+0.4	V
<b>V<sub>OL</sub> Current at VSS+0.4V, Output set low</b>				
(std. drive, 0.5mA) (Note 1)	1	2	4	mA
(high-drive, 3mA) (Note 1)	3	-	-	mA
(high-drive, 5mA) (Note 2)	6	10	15	mA
<b>V<sub>OL</sub> Current at VDD -0.4, Output set low</b>				
(std. drive, 0.5mA) (Note 1)	1	2	4	mA
(high-drive, 3mA) (Note 1)	3	-	-	mA
(high-drive, 5mA) (Note 2)	6	9	14	mA
Pull up resistance	11	13	16	kΩ
Pull down resistance	11	13	16	kΩ
Pad capacitance		3		pF
Pad capacitance at NFC pads		4		pF

**Signal Levels Notes:**

- Note 1** For VDD ≥ 1.7V. The firmware supports high drive (3 mA, as well as standard drive).
- Note 2** For VDD ≥ 2.7V. The firmware supports high drive (5 mA (since VDD ≥ 2.7V), as well as standard drive).  
The GPIO (SIO) high reference voltage always equals the level on the **VDD** pin.
- Normal voltage mode – The GPIO high level equals the voltage supplied to the VDD pin
  - High voltage mode – The GPIO high level equals the level specified (is configurable to 1.8V, 2.1V, 2.4V, 2.7V, 3.0V, and 3.3V. The default voltage is 1.8V). In High voltage mode, the VDD pin becomes an output voltage pin. The VDD output voltage and hence the GPIO is configurable from 1.8V to 3.3V with possible settings of 1.8V, 2.1V, 2.4V, 2.7V, 3.0V, and 3.3V.

**Table 5: SIO pin alternative function AIN (ADC) specification**

Parameter	Min	Typ	Max	Unit
<b>Maximum sample rate</b>			<b>200</b>	<b>kHz</b>
ADC Internal reference voltage	-1.5%	0.6 V	+1.5%	%
ADC pin input internal selectable scaling		4, 2, 1, 1/2, 1/3, 1/4, 1/5 1/6		scaling
ADC input pin (AIN) voltage maximum without damaging ADC w.r.t (see Note 1)				
VCC Prescaling				
0V-VDD	4, 2, 1, ½, 1/3, ¼, 1/5, 1/6	VDD+0.3		V
Configurable Resolution	8-bit mode	10-bit mode	12-bit mode	bits
Configurable (see Note 2)				
Acquisition Time, source resistance ≤10kΩ		3		µS
Acquisition Time, source resistance ≤40kΩ		5		µS
Acquisition Time, source resistance ≤100kΩ		10		µS
Acquisition Time, source resistance ≤200kΩ				

Parameter	Min	Typ	Max	Unit
<b>Maximum sample rate</b>			<b>200</b>	<b>kHz</b>
Acquisition Time, source resistance $\leq 400k\Omega$		15		$\mu\text{s}$
Acquisition Time, source resistance $\leq 800k\Omega$		20		$\mu\text{s}$
		40		$\mu\text{s}$
Conversion Time (see <a href="#">Note 3</a> )		<2		$\mu\text{s}$
ADC input impedance (during operation) (see <a href="#">Note 3</a> )				
Input Resistance		>1		M $\Omega$
Sample and hold capacitance at maximum gain		2.5		pF

**Recommended Operating Parameters Notes:**

<b>Note 1</b>	Stay within internal 0.6 V reference voltage with given pre-scaling on AIN pin and do not violate ADC maximum input voltage (for damage) for a given VCC, e.g. If VDD is 3.6V, you can only expose AIN pin to VDD+0.3 V. Default pre-scaling is 1/6 which configurable via smartBASIC.
<b>Note 2</b>	Firmware allows configurable resolution (8-bit, 10-bit or 12-bit mode) and acquisition time. BL653 ADC is a Successive Approximation type ADC (SSADC), as a result no external capacitor is needed for ADC operation. Configure the acquisition time according to the source resistance that customer has.  The sampling frequency is limited by the sum of sampling time and acquisition time. The maximum sampling time is 2 $\mu\text{s}$ . For acquisition time of 3 $\mu\text{s}$ the total conversion time is therefore 5 $\mu\text{s}$ , which makes maximum sampling frequency of 1/5 $\mu\text{s}$ = 200kHz. Similarly, if acquisition time of 40 $\mu\text{s}$ chosen, then the conversion time is 42 $\mu\text{s}$ and the maximum sampling frequency is 1/42 $\mu\text{s}$ = 23.8kHz.
<b>Note 3</b>	ADC input impedance is estimated mean impedance of the ADC (AIN) pins.

## 3.4 Programmability

### 3.4.1 BL653 Default Firmware

The BL653 module comes loaded with *smartBASIC* firmware but does not come loaded with any *smartBASIC* application script (as that is dependent on customer-end application or use). Laird Connectivity provides many sample *smartBASIC* application scripts via a sample application folder on GitHub – <https://github.com/LairdCP/BL653-Applications>

Therefore, it boots into AT command mode by default.

### 3.4.2 BL653 Special Function Pins in *smartBASIC*

Refer to the *smartBASIC* extension manual for details of functionality connected to this:

- nAutoRUN pin (SIO\_35), see Table 6 for default
- VSP pin (SIO\_02), see Table 7 for default
- SIO\_38 – Reserved for future use. Do not connect. See Table 8

**Table 6: nAutoRUN pin**

Signal Name	Pin #	I/O	Comments
nAutoRUN /(SIO_35)	5	I	Input with active low logic. Internal pull down (default). Operating mode selected by nAutoRun pin status: <ul style="list-style-type: none"> <li>▪ Self-contained Run mode (nAutoRUN pin held at 0V)</li> <li>▪ If Low (0V), runs \$autorun\$ if it exists</li> <li>▪ Interactive/Development mode (nAutoRUN pin held at VCC)</li> <li>▪ If High (VCC), runs via AT+rRUN (and file name of application)</li> </ul>

In the development board nAutoRUN pin is connected so that the state is driven by the host's DTR output line.

**Table 7: VSP mode**

Signal Name	Pin #	I/O	Comments
SIO_02	50	I	Internal pull down (default). VSP mode selected by externally pulling-up SIO_02 pin: <b>High (VCC)</b> , then OTA <i>smartBASIC</i> application download is possible.

**Table 8: SIO\_38**

Signal Name	Pin #	I/O	Comments
SIO_38	63	I	Internal pull up (default). Reserved for future use. Do not connect if using <i>smartBASIC</i> FW.

## 4 POWER CONSUMPTION

Data at VDD of 3.3 V with internal (to chipset) LDO(REG1) ON or with internal (to chipset) DCDC(REG1) ON (see Power Consumption

Note 1) and 25°C.

### 4.1 Power Consumption

**Table 9: Power consumption**

Parameter	Min	Typ	Max	Unit
<b>Active mode 'peak' current (Note 1)</b> <b>(Advertising or Connection)</b>		With DCDC [with LDO]		
Tx only run peak current @ Txpwr = +8 dBm		14.2 [30.4]		mA
Tx only run peak current @ Txpwr = +4 dBm		9.6 [20.7]		mA
Tx only run peak current @ Txpwr = 0 dBm		4.9 [10.3]		mA
Tx only run peak current @ Txpwr = -4 dBm		3.8 [8.0]		mA
Tx only run peak current @ Txpwr = -8 dBm		3.4 [7.1]		mA
Tx only run peak current @ Txpwr = -12 dBm		3.1 [6.4]		mA
Tx only run peak current @ Txpwr = -16 dBm		2.9 [5.9]		mA
Tx only run peak current @ Txpwr = -20 dBm		2.7 [5.5]		mA
Tx only run peak current @ Txpwr = -40 dBm		2.3 [4.5]		mA
<b>Active Mode</b>				
Rx only 'peak' current, BLE 1Mbps (Note 1)		4.6 [9.6]		mA
Rx only 'peak' current, BLE 2Mbps (Note 2)		5.2 [10.7]		mA
<b>Ultra-Low Power Mode 1 (Note 2)</b> Standby Doze, 256k RAM retention		2.6		uA
<b>Ultra-Low Power Mode 2 (Note 3)</b> Deep Sleep (no RAM retention)		0.6		uA
<b>Active Mode Average current (Note 4)</b> <b>Advertising Average Current draw</b>				
<b>Max</b> , with advertising interval (min) 20 mS		Note 4		uA
<b>Min</b> , with advertising interval (max) 10240 mS		Note 4		uA
<b>Connection Average Current draw</b>				
<b>Max</b> , with connection interval (min) 7.5 mS		Note 4		uA
<b>Min</b> , with connection interval (max) 4000 mS		Note4		uA

**Power Consumption Notes:**

<b>Note 1</b>	This is for Peak Radio Current only, but there is additional current due to the MCU. The internal DCDC convertor (REG1) or LDO (REG1) is decided by the underlying BLE stack.
<b>Note 2</b>	<p>BL653 modules Standby Doze is 2.6 <math>\mu</math>A typical. When using smartBASIC firmware, Standby Doze is entered automatically (when a waitevent statement is encountered within a smartBASIC application script). In Standby Doze, all peripherals that are enabled stay on and may re-awaken the chip. Depending on active peripherals, current consumption ranges from 2.6 <math>\mu</math>A to 370 <math>\mu</math>A (when UART is ON). See individual peripherals current consumption data in the Peripheral Block Current Consumption section. smartBASIC firmware has functionality to detect GPIO change with no current consumption cost, it is possible to close the UART and get to the 2.6 <math>\mu</math>A current consumption regime and still be able to detect for incoming data and be woken up so that the UART can be re-opened at expense of losing that first character.</p> <p>The BL653 Standby Doze current (at 25°C) consists of the below nRF52833 blocks:</p> <ul style="list-style-type: none"> <li>▪ nRF52 System ON IDLE current (no RAM retention) (1.1 <math>\mu</math>A) – This is the base current of the CPU</li> <li>▪ LFRC (0.7 <math>\mu</math>A) and RTC (0.1<math>\mu</math>A or near 0<math>\mu</math>A) running as well as 128k RAM retention (0.8 <math>\mu</math>A) – This adds to the total of 2.7 <math>\mu</math>A typical. The RAM retention is 20nA per 4k block, but this can vary to 30nA per 4k block which would make the total 2.55<math>\mu</math>A to 2.86<math>\mu</math>A.</li> </ul>
<b>Note 3</b>	<p>In Deep Sleep, everything is disabled and the only wake-up sources (including NFC to wakeup) are reset and changes on SIO or NFC pins on which sense is enabled. The current consumption seen is ~0.6 <math>\mu</math>A typical in BL653 modules.</p> <ul style="list-style-type: none"> <li>▪ Coming out from Deep Sleep to Standby Doze through the reset vector.</li> </ul>
<b>Note 4</b>	<p>Average current consumption depends on several factors (including Tx power, VCC, accuracy of 32MHz and 32.768 kHz). With these factors fixed, the largest variable is the advertising or connection interval set.</p> <p>Advertising Interval range:</p> <ul style="list-style-type: none"> <li>▪ 20 milliseconds to 10240 mS (10485759.375 mS in BT5.1) in multiples of 0.625 milliseconds.</li> </ul> <p>For an advertising event:</p> <ul style="list-style-type: none"> <li>▪ The minimum average current consumption is when the advertising interval is large 10240 mS (10485759.375 mS (in BT5.0) although this may cause long discover times (for the advertising event) by scanners</li> <li>▪ The maximum average current consumption is when the advertising interval is small 20 mS</li> <li>▪ Other factors that are also related to average current consumption include the advertising payload bytes in each advertising packet and whether it's continuously advertising or periodically advertising.</li> </ul> <p>Connection Interval range (for a peripheral):</p> <ul style="list-style-type: none"> <li>▪ 7.5 milliseconds to 4000 milliseconds in multiples of 1.25 milliseconds.</li> </ul> <p>For a connection event (for a peripheral device):</p> <ul style="list-style-type: none"> <li>▪ The minimum average current consumption is when the connection interval is large 4000 milliseconds</li> <li>▪ The maximum average current consumption is with the shortest connection interval of 7.5 ms; no slave latency.</li> </ul> <p>Other factors that are also related to average current consumption include:</p> <ul style="list-style-type: none"> <li>▪ Number packets per connection interval with each packet payload size</li> <li>▪ An inaccurate 32.768 kHz master clock accuracy would increase the average current consumption.</li> </ul> <p>Connection Interval range (for a central device):</p> <ul style="list-style-type: none"> <li>▪ 2.5 milliseconds to 40959375 milliseconds in multiples of 1.25 milliseconds.</li> </ul>

## 4.2 Peripheral Block Current Consumption

The values below are calculated for a typical operating voltage of 3V.

**Table 10: UART power consumption**

Parameter	Min	Typ	Max	Unit
UART Run current @ 115200 bps	-	55	-	uA
UART Run current @ 1200 bps	-	55	-	uA
Idle current for UART (no activity)	-	1	-	uA
UART Baud rate	1.2	-	1000	kbps

**Table 11: Power consumption**

Parameter	Min	Typ	Max	Unit
SPI Master Run current @ 2 Mbps	-	-	50	uA
SPI Master Run current @ 8 Mbps	-	-	50	uA
Idle current for SPI (no activity)	-	<1	-	uA
SPI bit rate	-	-	8	Mbps

**Table 12: I2C power consumption**

Parameter	Min	Typ	Max	Unit
I2C Run current @ 100 kbps	-	50	-	uA
I2C Run current @ 400 kbps	-	50	-	uA
I2C Bit rate	100	-	400	kbps

**Table 13: ADC power consumption**

Parameter	Min	Typ	Max	Unit
ADC current during conversion	-	700	-	uA

The above current consumption is for the given peripheral only and to operate that peripheral requires some other internal blocks which consume current (base current). This base current is consumed when the UART, SPI, I2C, or ADC is opened (operated).

For asynchronous interface, like the UART (asynchronous as the other end can communicate at any time), the UART on the BL653 must be kept open (by a command in *smartBASIC* application script), resulting in the base current consumption penalty.

For a synchronous interface like the I2C or SPI (since BL653 side is the master), the interface can be closed and opened (by a command in *smartBASIC* application script) only when needed, resulting in current saving (no base current consumption penalty). There's a similar argument for ADC (open ADC when needed).



## 5 FUNCTIONAL DESCRIPTION

To provide the widest scope for integration, a variety of physical host interfaces/sensors are provided. The major BL653 series module functional blocks described below.

### 5.1 Power Management

Power management features:

- System Standby Doze and Deep Sleep modes
- Open/Close peripherals (UART, SPI, I2C, SIO's, ADC, NFC). Peripherals consume current when open; each peripheral can be individually closed to save power consumption
- Use of the internal DCDC (REG1) convertor or LDO (REG1) is decided by the underlying BLE stack
- *smartBASIC* command allows the supply voltage to be read (through the internal ADC)
- Pin wake-up system from deep sleep (including from NFC pins)

Power supply features:

- Supervisor hardware to manage power during reset, brownout, or power fail.
- 1.7V to 3.6V supply range for normal power supply (VDD pin) using internal DCDC convertor (REG1) or LDO(REG1) decided by the underlying BLE stack.
- 2.5V to 5.5 supply range for High voltage power supply (VDD\_HV pin) using internal LDO(REG0).
- 4.35V to 5.5V supply range for powering USB (VBUS pin) portion of BL653 only. The remainder of the BL653 module circuitry must still be powered through the VDD (or VDD\_HV) pin.

### 5.2 BL653 Power Supply Options

The BL653 module power supply internally contains the following two main supply regulator stages (Figure 4):

- REG0 – Connected to the VDD\_HV pin
- REG1 – Connected to the VDD pin

The USB power supply is separate (connected to the VBUS pin).

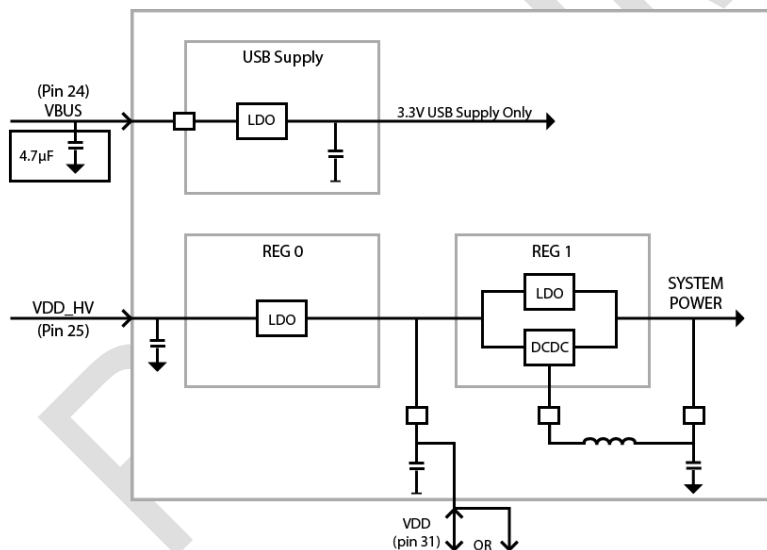

**Figure 4: BL653 power supply block diagram (adapted from the following resource: [http://infocenter.nordicsemi.com/pdf/nRF52833\\_PS\\_v1.0.pdf](http://infocenter.nordicsemi.com/pdf/nRF52833_PS_v1.0.pdf))**

The BL653 power supply system enters one of two supply voltage modes, normal or high voltage mode, depending on how the external supply voltage is connected to these pins.



BL653 power supply options:

- **Option 1** – Normal voltage power supply mode entered when the external supply voltage is connected to both the VDD and VDD\_HV pins (so that VDD equals VDD\_HV). Connect external supply within range 1.7V to 3.6V range to BL653 VDD and VDD\_HV pins.

OR

- **Option 2** – High voltage mode power supply mode (using BL653 VDD\_HV pin) entered when the external supply voltage in ONLY connected to the VDD\_HV pin and the VDD pin is not connected to any external voltage supply. Connect external supply within range 2.5V to 5.5V range to BL653 VDD\_HV pin. BL653 VDD pin left unconnected.  
No external current draw (from VDD pin) is allowed when using High Voltage mode (VDD\_HV), limitation of the nRF52833 chip.

**Note:** To avoid surpassing the maximum die temperature (110 °C), it is important to minimize current consumption when operating in the extended operating temperature conditions (+85 °C to +105°C). It is therefore recommended to use the module device on Normal Voltage mode with DCDC (REG1) enabled.

For either option, if you use USB interface then the BL653 VBUS pin must be connected to external supply within the range 4.35V to 5.5V. When using the BL653 VBUS pin, you **MUST** externally fit a 4.7uF to ground.

Table 14 summarizes these power supply options.

**Table 14: BL653 powering options**

Power Supply Pins and Operating Voltage Range	OPTION 1 Normal voltage mode operation connect?	OPTION 2 High voltage mode operation connect?	OPTION 1 with USB peripheral, and normal voltage mode operation connect?	OPTION 2 with USB peripheral, and high voltage operation connect?
VDD (pin31) 1.7V to 3.6V	Yes (Note 1)	No (Note 2)	Yes	No (Note 2)
VDD_HV (pin25) 2.5V to 5.5V	No	Yes	No	Yes (Note 5)
VBUS (pin24) 4.35V to 5.5V	No	(Note 3)	Yes (Note 4)	Yes (Note 4)

**Power Supply Option Notes:**

<b>Note 1</b>	<b>Option 1</b> – External supply voltage is connected to BOTH the VDD and VDD_HV pins (so that VDD equals VDD_HV). Connect external supply within range 1.7V to 3.6V range to BOTH BL653 VDD and VDD_HV pins.
<b>Note 2</b>	<b>Option 2</b> – External supply within range 2.5V to 5.5V range to the BL653 VDD_HV pin ONLY. BL653 VDD pin left unconnected.  In High voltage mode, the VDD pin becomes an output voltage pin but no current can be taken from VDD pin (limitation of the nRF52833 chip). It Additionally, the VDD output voltage is configurable from 1.8V to 3.3V with possible settings of 1.8V, 2.1V, 2.4V, 2.7V, 3.0V, and 3.3V. The default voltage is 1.8V.  The supported BL653 VDD pin output voltage range depends on the supply voltage provided on the BL653 VDD_HV pin. The minimum difference between voltage supplied on the VDD_HV pin and the voltage output on the VDD pin is 0.3 V. The maximum output voltage of the VDD pin is VDDH – 0.3V.
<b>Note 3</b>	Depends on whether USB operation is required
<b>Note 4</b>	When using the BL653 VBUS pin, you <b>must</b> externally fit a 4.7uF capacitor to ground.

**Power Supply Option Notes:**

- Note 5** To use the BL653 USB peripheral:
1. Connect the BL653 VBUS pin to the external supply within the range 4.35V to 5.5V. When using the BL653 VBUS pin, you **MUST** externally fit a 4.7 $\mu$ F to ground.
  2. Connect the external supply to either the VDD (Option 1) or VDD\_HV (Option 2) pin to operate the rest of BL653 module.  
When using the BL653 USB peripheral, the VBUS pin can be supplied from same source as VDD\_HV (within the operating voltage range of the VBUS pin and VDD\_HV pin).

## 5.3 Clocks and Timers

### 5.3.1 Clocks

The integrated high accuracy 32 MHz ( $\pm 10$  ppm) crystal oscillator helps with radio operation and reducing power consumption in the active modes.

The integrated on-chip 32.768 kHz LFRC oscillator ( $\pm 500$  ppm) provides protocol timing and helps with radio power consumption in the system StandByDoze and Deep Sleep modes by reducing the time that the RX window needs to be open.

To keep the on-chip 32.768 kHz LFRC oscillator within  $\pm 500$  ppm (which is needed to run the BLE stack) accuracy, RC oscillator needs to be calibrated (which takes 33 mS) regularly. The default calibration interval is eight seconds which is enough to keep within  $\pm 500$  ppm. The calibration interval ranges from 0.25 seconds to 31.75 seconds (in multiples of 0.25 seconds) and configurable via firmware

### 5.3.2 Timers

When using *smartBASIC*, the timer subsystem enables applications to be written which allow future events to be generated based on timeouts.

- **Regular Timer** – There are eight built-in timers (regular timers) derived from a single RTC clock which are controlled solely by smart BASIC functions. The resolution of the regular timer is 976 microseconds.
- **Tick Timer** – A 31-bit free running counter that increments every (1) millisecond. The resolution of this counter is 488 microseconds.

Refer to the *smartBASIC User Guide* available from the Laird Connectivity BL653 product page. For timer utilization when using the Nordic SDK, refer to <http://infocenter.nordicsemi.com/index.jsp>.

## 5.4 Radio Frequency (RF)

- 2402–2480 MHz Bluetooth Low Energy radio BT5.1 – 1 Mbps, 2 Mbps, and long-range (125 kbps and 500 kbps) over-the-air data rate.
- Tx output power of +8 dBm programmable down to 7 dBm, 6 dBm, 5 dBm, 4 dBm, 2 dBm, 0 dBm and further down to -20 dBm in steps of 4 dB and final TX power level of -40 dBm.
- Receiver (with integrated channel filters) to achieve maximum sensitivity -96 dBm @ 1 Mbps BLE, -92 dBm @ 2 Mbps, -103 dBm @ 125 kbps long-range and -99 dBm @ 500 kbps long-range).
- RF conducted interface available in the following two ways:
  - 453-00039: RF connected to on-board PCB trace antenna
  - 453-00041: RF connected to RF pad on BL653
- Antenna options:
  - Integrated PCB trace antenna on the 453-00039
  - External dipole antenna connected to IPEX MH4 RF connector on host PCB. If using the BL653 module RF pad variant (453-00041), customer **MUST** copy the 50-Ohms GCPW RF track design, **MUST** add series 2nH RF inductor (Murata LQG15HN2N0B02# or Murata LQG15HS2N0B02) and RF connector IPEX MHF4 Receptacle (MPN: 20449-001E) Detailed in the following section: **50-Ohms RF Trace and RF Match Series 2nH RF Inductor on Host PCB for BL653 RF Pad Variant (453-00041)**.
- Received Signal Strength Indicator (RSSI)
  - RSSI accuracy (valid range -90 to -20 dBm) is  $\pm 2$  dB typical
  - RSSI resolution 1 dB typical

## 5.5 NFC

NFC support:

- Based on the NFC forum specification
  - 13.56 MHz
  - Data rate 106 kbps
  - NFC Type2 and Type4 tag emulation
- Modes of operation:
  - Disable
  - Sense
  - Activated

### 5.5.1 Use Cases

- Touch-to Pair with NFC
- Launch a smartphone app (on Android)
- NFC enabled Out-of-Band Pairing
- System Wake-On-Field function
  - Proximity Detection

Table 15: NFC interface

Signal Name	Pin No	I/O	Comments
NFC1/SIO_09	59	I/O	The NFC pins are by default NFC pins and an alternate function on each pin is GPIO. Refer to the <i>smartBASIC</i> . User manual.
NFC2/SIO_10	57	I/O	

### 5.5.2 NFC Antenna Coil Tuning Capacitors

From Nordic's *nRF52833 Objective Product Specification v1.0*: [http://infocenter.nordicsemi.com/pdf/nRF52833\\_PS\\_v1.0.pdf](http://infocenter.nordicsemi.com/pdf/nRF52833_PS_v1.0.pdf)

The NFC antenna coil must be connected differential between the NFC1 and NFC2 pins of the BL653. Two external capacitors should be used to tune the resonance of the antenna circuit to 13.56 MHz (Figure 5).

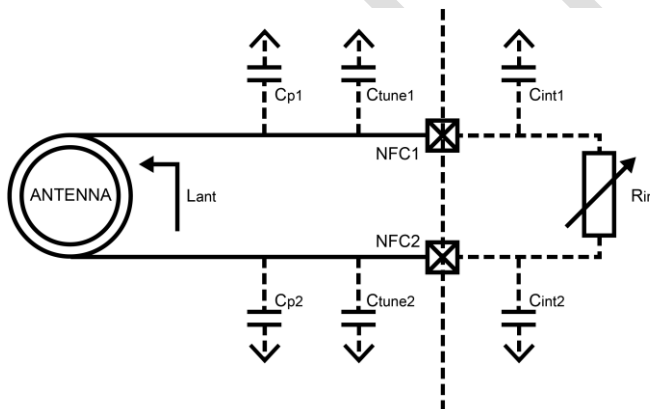

Figure 5: NFC antenna coil tuning capacitors

The required external tuning capacitor value is given by the following equations:

$$C_{tune} = \frac{2}{(2\pi \cdot 13.56 \text{ MHz})^2 \cdot L_{ant}} - C_{tune} - C_{int}$$

An antenna inductance of  $L_{ant} = 0.72 \mu\text{H}$  provides tuning capacitors in the range of 300 pF on each pin. The total capacitance on NFC1 and NFC2 must be matched.  $C_{int}$  and  $C_p$  are small usually ( $C_{int}$  is 4pF), so can omit from calculation.

**Battery Protection Note:** If the NFC coil antenna is exposed to a strong NFC field, the supply current may flow in the opposite direction due to parasitic diodes and ESD structures.

If the used battery does not tolerate a return current, a series diode must be placed between the battery and the BL653 to protect the battery.

## 5.6 UART Interface

**Note:** The BL653 has two UARTs.

The Universal Asynchronous Receiver/Transmitter (UART) offers fast, full-duplex, asynchronous serial communication with built-in flow control support (UART\_CTS, UART\_RTS) in HW up to one Mbps baud. Parity checking and generation for the ninth data bit are supported.

UART\_TX, UART\_RX, UART\_RTS, and UART\_CTS form a conventional asynchronous serial data port with handshaking. The interface is designed to operate correctly when connected to other UART devices such as the 16550A. The signaling levels are nominal 0 V and 3.3 V (tracks VDD) and are inverted with respect to the signaling on an RS232 cable.

Two-way hardware flow control is implemented by UART\_RTS and UART\_CTS. UART\_RTS is an output and UART\_CTS is an input. Both are active low.

These signals operate according to normal industry convention. UART\_RX, UART\_TX, UART\_CTS, UART\_RTS are all 3.3 V level logic (tracks VDD). For example, when RX and TX are idle they sit at 3.3 V. Conversely for handshaking pins CTS, RTS at 0 V is treated as an assertion.

The module communicates with the customer application using the following signals:

- Port/TxD of the application sends data to the module's UART\_RX signal line
- Port/RxD of the application receives data from the module's UART\_TX signal line

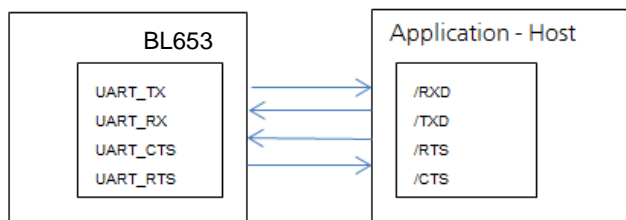

**Figure 6: UART signals**

**Note:** The BL653 serial module output is at 3.3V CMOS logic levels (tracks VDD). Level conversion must be added to interface with an RS-232 level compliant interface.

Some serial implementations link CTS and RTS to remove the need for handshaking. We do not recommend linking CTS and RTS other than for testing and prototyping. If these pins are linked and the host sends data at the point that the BL653 deasserts its RTS signal, there is significant risk that internal receive buffers will overflow, which could lead to an internal processor crash. This will drop the connection and may require a power cycle to reset the module. We recommend that the correct CTS/RTS handshaking protocol be adhered to for proper operation.

**Table 16: UART interface**

Signal Name	Pin No.	I/O	Comments
SIO_06 / UART_Tx	35	O	SIO_06 (alternative function UART_Tx) is an output, set high (in firmware).
SIO_08 / UART_Rx	29	I	SIO_08 (alternative function UART_Rx) is an input, set with internal pull-up (in firmware).
SIO_05 / UART_RTS	39	O	SIO_05 (alternative function UART_RTS) is an output, set low (in firmware).

Signal Name	Pin No.	I/O	Comments
SIO_07 / UART_CTS	37	I	SIO_07 (alternative function UART_CTS) is an input, set with internal pull-down (in firmware).

The UART interface is also used to load customer developed *smartBASIC* application script.

## 5.7 USB Interface

BL653 has USB 2.0 FS (Full Speed, 12 Mbps) hardware capability. There is a CDC driver/Virtual UART as well as other USB drivers available via Nordic SDK – such as: `usb_audio`, `usb_hid`, `usb_generic`, `usb_msc` (mass storage device).

**Table 17: USB interface**

Signal Name	Pin No	I/O	Comments
D-	17	I/O	
D+	15	I/O	
VBUS	24		When using the BL653 VBUS pin (which is mandatory when USB interface is used), Customer MUST connect externally a 4.7uF capacitor to ground. <b>Note:</b> You MUST power the rest of BL653 module circuitry through the VDD pin (OPTION1) or VDD_HV pin (OPTION2).

## 5.8 SPI Bus

The SPI interface is an alternate function on SIO pins.

The module is a master device that uses terminals SPI\_MOSI, SPI\_MISO, and SPI\_CLK. SPI\_CS is implemented using any spare SIO digital output pins to allow for multi-dropping.

The SPI interface enables full duplex synchronous communication between devices. It supports a three-wire (SPI\_MOSI, SPI\_MISO, SPI\_SCK,) bidirectional bus with fast data transfers to and from multiple slaves. Individual chip select signals are necessary for each of the slave devices attached to a bus, but control of these is left to the application through use of SIO signals. I/O data is double buffered.

The SPI peripheral supports SPI mode 0, 1, 2, and 3.

**Table 18: SPI interfaces**

Signal Name	Pin No	I/O	Comments
SIO_40/SPI_MOSI	32	O	This interface is an alternate function configurable by <i>smartBASIC</i> . Default in the FW pin 56 and 53 are SIO inputs. SPIOPEN() in <i>smartBASIC</i> selects SPI function and changes pin 56 and 53 to outputs (when in SPI master mode).
SIO_04/AIN2/SPI_MISO	34	I	
SIO_41/SPI_CLK	30	O	
Any_SIO/SPI_CS	54	I	SPI_CS is implemented using any spare SIO digital output pins to allow for multi-dropping. On Laird Connectivity devboard SIO_44 (pin54) used as SPI_CS.

## 5.9 I2C Interface

The I2C interface is an alternate function on SIO pins.

The two-wire interface can interface a bi-directional wired-OR bus with two lines (SCL, SDA) and has master /slave topology. The interface is capable of clock stretching. Data rates of 100 kbps and 400 kbps are supported.

An I2C interface allows multiple masters and slaves to communicate over a shared wired-OR type bus consisting of two lines which normally sit at VDD. The SCL is the clock line which is always sourced by the master and SDA is a bi-directional data line which can be driven by any device on the bus.

**IMPORTANT:** It is essential to remember that pull-up resistors on both SCL and SDA lines are not provided in the module and MUST be provided external to the module.

**Table 19: I2C interface**

Signal Name	Pin No	I/O	Comments
SIO_26/I2C_SDA	36	I/O	This interface is an alternate function on each pin, configurable by <i>smartBASIC</i> . I2COPEN() in <i>smartBASIC</i> selects I2C function.
SIO_27/I2C_SCL	38	I/O	

## 5.10 General Purpose I/O, ADC, PWM, and FREQ

### 5.10.1 GPIO

The 42 SIO pins are configurable by *smartBASIC* application script or Nordic SDK. They can be accessed individually. Each has the following user configured features:

- Input/output direction
- Output drive strength (standard drive 0.5 mA or high drive 5mA)
- Internal pull-up and pull-down resistors (13 K Ohms typical) or no pull-up/down or input buffer disconnect
- Wake-up from high or low-level triggers on all pins including NFC pins

### 5.10.2 ADC

The ADC is an alternate function on SIO pins, configurable by *smartBASIC* or Nordic SDK.

The BL653 provides access to 8-channel 8/10/12-bit successive approximation ADC in one-shot mode. This enables sampling up to 8 external signals through a front-end MUX. The ADC has configurable input and reference pre-scaling and sample resolution (8, 10, and 12 bit).

#### 5.10.2.1 Analog Interface (ADC)

**Table 20: Analog interface**

Signal Name	Pin No	I/O	Comments
SIO_05/UART_RTS/AIN3 – Analog Input	39	I	This interface is an alternate function on each pin, configurable by <i>smartBASIC</i> . AIN configuration selected using GpioSetFunc() function.
SIO_04/AIN2/SPI_MISO – Analog Input	34	I	
SIO_03/AIN1 – Analog Input	49	I	Configurable 8, 10, 12-bit resolution.
SIO_02/AIN0 – Analog Input	50	I	
SIO_31/AIN7 – Analog Input	44	I	Configurable voltage scaling 4, 2, 1/1, 1/3, 1/3, 1/4, 1/5, 1/6(default).
SIO_30/AIN6 – Analog Input	45	I	
SIO_29/AIN5 – Analog Input	48	I	Configurable acquisition time 3uS, 5uS, 10uS(default), 15uS, 20uS, 40uS.
SIO_28/AIN4 – Analog Input	46	I	

### 5.10.3 PWM Signal Output on Up to 16 SIO Pins

The PWM output is an alternate function on ALL (GPIO) SIO pins, configurable by *smartBASIC* or the Nordic SDK.

The **PWM output** signal has a frequency and duty cycle property. Frequency is adjustable (up to 1 MHz) and the duty cycle can be set over a range from 0% to 100%.

PWM output signal has a frequency and duty cycle property. PWM output is generated using dedicated hardware in the chipset. There is a trade-off between PWM output frequency and resolution.

For example:

- PWM output frequency of 500 kHz (2 uS) results in resolution of 1:2
- PWM output frequency of 100 kHz (10 uS) results in resolution of 1:10
- PWM output frequency of 10 kHz (100 uS) results in resolution of 1:100
- PWM output frequency of 1 kHz (1000 uS) results in resolution of 1:1000

### 5.10.4 FREQ Signal Output on Up to 16 SIO Pins

The FREQ output is an alternate function on 16 (GPIO) SIO pins, configurable by *smartBASIC* or Nordic SDK.

**Note:** The frequency driving each of the 16 SIO pins is the same but the duty cycle can be independently set for each pin.

**FREQ output** signal frequency can be set over a range of 0Hz to 4 MHz (with 50% mark-space ratio).

## 5.11 nRESET Pin

Table 21: nRESET pin

Signal Name	Pin No	I/O	Comments
nRESET	19	I	BL653 HW reset (active low). Pull the nRESET pin low for minimum 100 mS for the BL653 to reset.

## 5.12 Two-Wire Interface SWD (JTAG)

The BL653 Firmware hex file consists of four elements:

- *smartBASIC* runtime engine
- Nordic Softdevice
- Master Bootloader

Laird Connectivity BL653 *smartBASIC* firmware (FW) image part numbers are referenced as w.x.y.z (ex. V30.x.y.z). The BL653 *smartBASIC* runtime engine and Softdevice combined image can be upgraded by the customer over the UART interface.

You also have the option to use the two-wire SWD (JTAG) interface, during production, to clone the file system of a Golden preconfigured BL653 to others using the Flash Cloning process. This is described in the following application note *Flash Cloning for the BL653*. In this case the file system is also part of the .hex file.

Signal Name	Pin No	I/O	Comments
SWDIO	1	I/O	Internal pull-up resistor
SWDCLK	3	I	Internal pull-down resistor

The Laird Connectivity development board incorporates an on-board SWD (JTAG) J-link programmer for this purpose. There is also the following SWD (JTAG) connector which allows on-board SWD (JTAG) J-link programmer signals to be routed off the development board. The only requirement is that you should use the following SWD (JTAG) connector on the host PCB.

The SWD (JTAG) connector MPN is as follows:



Reference	Part	Description and MPN (Manufacturers Part Number)
JP1	FTSH-105	Header, 1.27mm, SMD, 10-way, FTSH-105-01-L-DV Samtech

**Note:** Reference on the BL653 development board schematic (Figure 7) shows the DVK development schematic wiring only for the SWD (JTAG) connector and the BL653 module JTAG pins.

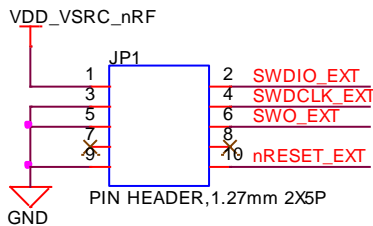

Figure 7: BL653 development board schematic

**Note:** The BL653 development board allows Laird Connectivity on-board SWD (JTAG) J-link programmer signals to be routed off the development board by from connector JP1

SWD (JTAG) is required because Nordic SDK applications can only be loaded using the SWED (JTAG) (*smartBASIC* firmware can be loaded using SWD (JTAG) as well as over the UART). We recommend that you use SWD (JTAG) (2-wire SWD interface) to handle future BL653 module firmware upgrades. You **must** wire out the JTAG (2-wire SWD interface) on your host design (see Figure 7, where the following four lines should be wired out – SWDIO, SWDCLK, GND, and VCC). *smartBASIC* firmware upgrades can still be performed over the BL653 UART interface, but this is slower than using the BL653 JTAG (2-wire SWD interface) – (60 seconds using UART vs. 10 seconds when using JTAG).

## 5.13 BL653 Wakeup

### 5.13.1 Waking Up BL653 From Host

Wake the BL653 from the host using wake-up pins (any SIO pin). You may configure the BL653's wakeup pins via *smartBASIC* to do any of the following:

- Wake up when signal is low
- Wake up when signal is high
- Wake up when signal changes

Refer to the *smartBASIC* user guide for details. You can access this guide from the Laird Connectivity BL653 product page.

For BL653 wake-up using the Nordic SDK, refer to Nordic [infocenter.nordicsemi.com](http://infocenter.nordicsemi.com).

## 5.14 Low Power Modes

The BL653 has three power modes: Run, Standby Doze, and Deep Sleep.

The module is placed automatically in Standby Doze if there are no pending events (when WAITEVENT statement is encountered within a customer's *smartBASIC* script). The module wakes from Standby Doze via any interrupt (such as a received character on the UART Rx line). If the module receives a UART character from either the external UART or the radio, it wakes up.

Deep sleep is the lowest power mode. Once awakened, the system goes through a system reset.

For different Nordic power modes using the Nordic SDK, refer to Nordic [infocenter.nordicsemi.com](http://infocenter.nordicsemi.com).



## 5.15 Temperature Sensor

The on-silicon temperature sensor has a temperature range greater than or equal to the operating temperature of the device. Resolution is 0.25°C degrees. The on-silicon temperature sensor accuracy is  $\pm 5^\circ\text{C}$ .

To read temperature from on-silicon temperature sensor (in tenth of centigrade, so 23.4°C is output as 234) using *smartBASIC*:

- In command mode, use **ATI2024**  
OR
- From running a *smartBASIC* application script, use **SYSINFO(2024)**

## 5.16 Security/Privacy

### 5.16.1 Random Number Generator

Exposed via an API in *smartBASIC* (see *smartBASIC* documentation available from the BL653 product page). The **rand()** function from a running *smartBASIC* application returns a value.

For Nordic related functionality, visit Nordic [infocenter.nordicsemi.com](http://infocenter.nordicsemi.com)

### 5.16.2 AES Encryption/Decryption

Exposed via an API in *smartBASIC* (see *smartBASIC* documentation available from the BL653 product page). Function called **aesencrypt** and **aesdecrypt**.

For Nordic related functionality, visit Nordic [infocenter.nordicsemi.com](http://infocenter.nordicsemi.com)

### 5.16.3 Readback Protection

The BL653 supports readback protection capability that disallows the reading of the memory on the nRF52833 using a JTAG interface. Available via *smartBASIC* or the Nordic SDK.

### 5.16.4 Elliptic Curve Cryptography

The BL653 offers a range of functions for generating public/private keypair, calculating a shared secret, as well as generating an authenticated hash. Available via *smartBASIC* or the Nordic SDK.

## 5.17 Optional External 32.768 kHz Crystal

This is not required for normal BL653 module operation.

The BL653 uses the on-chip 32.76 kHz RC oscillator (LFCLK) by default (which has an accuracy of  $\pm 500$  ppm) which requires regulator calibration (every eight seconds) to within  $\pm 500$  ppm.

You can connect an optional external high accuracy ( $\pm 20$  ppm) 32.768 kHz crystal (and associated load capacitors) to the BL653SIO\_01/XL2 (pin 41) and SIO\_00/XL1 (pin 42) to provide improved protocol timing and to help with radio power consumption in the system standby doze/deep sleep modes by reducing the time that the RX window needs to be open.

[Table 22](#) compares the current consumption difference between RC and crystal oscillator.

**Table 22: Comparing current consumption difference between BL653 on-chip RC 32.76 kHz oscillator and optional external crystal (32.768kHz) based oscillator**

	BL653 On-chip 32.768 kHz RC Oscillator ( $\pm 500$ ppm) LFRC	Optional External Higher Accuracy ( $\pm 20$ ppm) 32.768 kHz Crystal-based Oscillator LFXO
<b>Current Consumption of 32.768 kHz Block</b>	0.7 uA	0.23 uA
<b>Standby Doze Current (SYSTEM ON IDLE +full RAM retention +RTC)</b>	2.5 uA	2.03 uA

	BL653 On-chip 32.768 kHz RC Oscillator (±500 ppm) LFRC	Optional External Higher Accuracy (±20 ppm) 32.768 kHz Crystal-based Oscillator LFXO
<b>run current (0uA) + LFRC or LFXO)</b>		
<b>Calibration</b>	<p>Calibration required regularly (default eight seconds interval).</p> <p>Calibration takes 32 ms; with DCDC used, the total charge of a calibration event is 15.1 uC (or 18.8uC with DCDC disabled).</p> <p>The average current consumed by the calibration depends on the calibration interval and can be calculated using the following formula:</p> <p><b>CAL_charge/CAL_interval</b> – The lowest calibration interval (0.25 seconds) provides an average current of (DCDC enabled):</p> <p><b>15.1uC/0.25s = 60.4uA</b></p> <p>To get the 250-ppm accuracy, the BLE stack specification states that a calibration interval of 8 seconds is enough. This gives an average current of:</p> <p><b>15.1uC/8s = 1.89 uA</b></p> <p>Added to the LFRC run current and Standby Doze (IDLE) base current shown above results in a total average current of:</p> <p><b>LFRC + CAL = 2.5 + 1.89 = 4.39 uA</b></p>	Not applicable
<b>Total</b>	4.39 uA	2.03 uA
<b>Summary</b>	<ul style="list-style-type: none"> <li>▪ Low current consumption</li> <li>▪ Accuracy 250 ppm</li> </ul>	<ul style="list-style-type: none"> <li>▪ Lowest current consumption</li> <li>▪ Needs external crystal</li> <li>▪ High accuracy (depends on the crystal, usually 20 ppm)</li> </ul>

Table 23: Optional external 32.768 kHz crystal specification

Optional external 32.768kHz crystal	Min	Typ	Max
Crystal Frequency	-	32.768 kHz	-
Frequency tolerance requirement of BLE stack	-	-	±500 ppm
Load Capacitance	-	-	12.5 pF
Shunt Capacitance	-	-	2 pF
Equivalent series resistance	-	-	100 kOhm
Drive level	-	-	1 uW
Input capacitance on XL1 and XL2 pads	-	4 pF	-
Run current for 32.768 kHz crystal based oscillator	-	0.23 uA	-
Start-up time for 32.768 kHz crystal based oscillator	-	0.25 seconds	-
Peak to peak amplitude for external low swing clock input signal must not be outside supply rails	200 mV	-	1000 mV

Be sure to tune the load capacitors on the board design to optimize frequency accuracy (at room temperature) so it matches that of the same crystal standalone, Drive Level (so crystal operated within safe limits) and oscillation margin ( $R_{neg}$  is at least 3 to 5 times ESR) over the operating temperature range.

## 5.18 453-00039 On-board PCB Antenna Characteristics

The 453-00039 on-board PCB trace monopole antenna radiated performance depends on the host PCB layout.

The BL653 development board was used for BL653 development and the 453-00039 PCB antenna performance evaluation. To obtain similar performance, follow guidelines in section *PCB Layout on Host PCB for the 453-00039* to allow the on-board PCB antenna to radiate and reduce proximity effects due to nearby host PCB GND copper or metal covers.

Unit in dBi @2440MHz	XY-plane		XZ-plane		YZ-plane	
	Peak	Avg	Peak	Avg	Peak	Avg
453-00039 PCB trace antenna	-0.94	-4.92	-3.41	-6.7	-3.14	-8.64

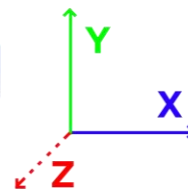
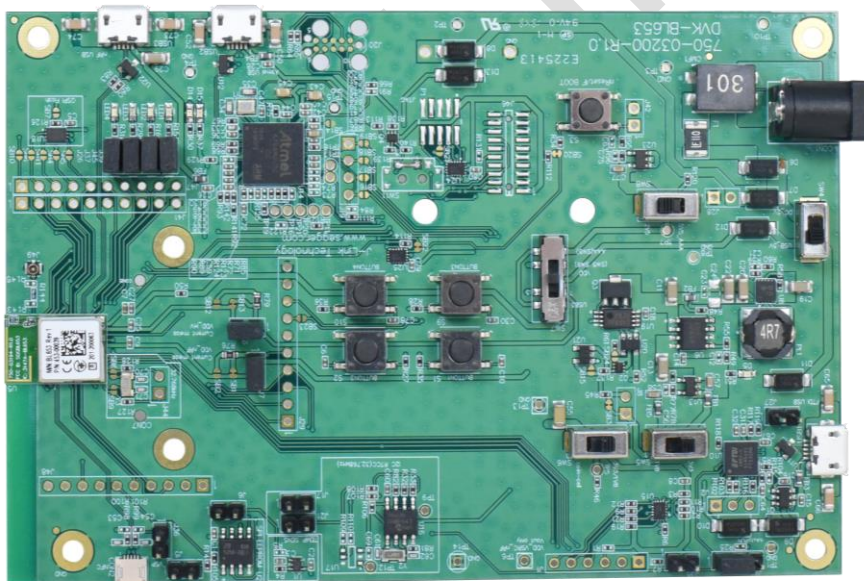
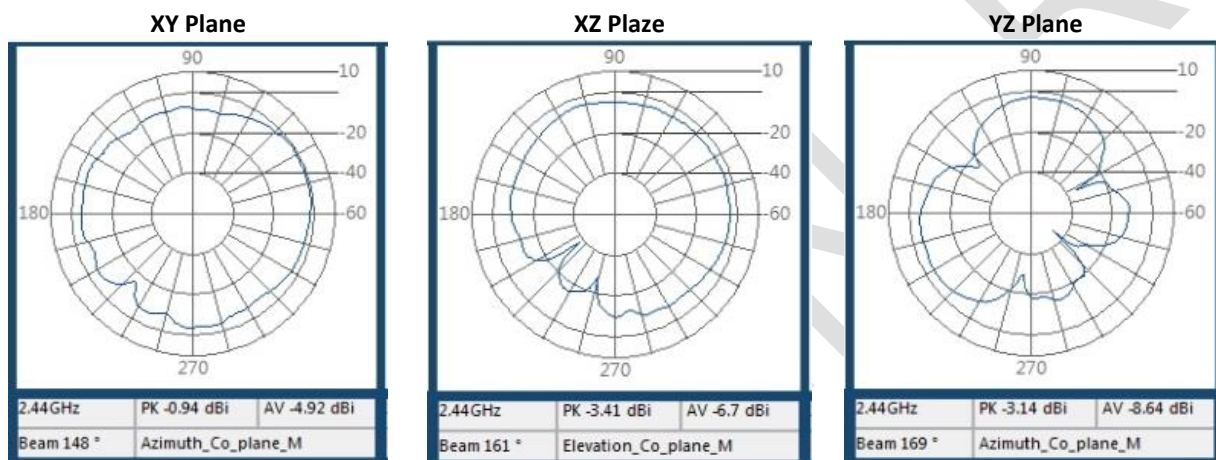

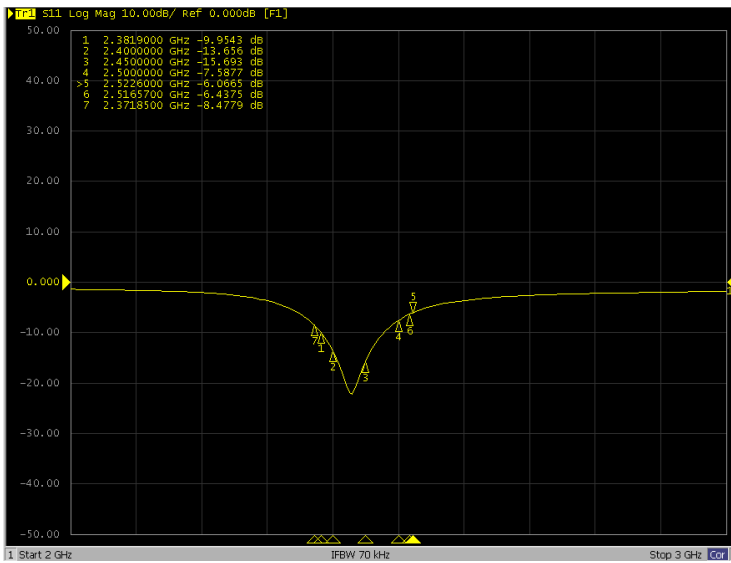

Figure 8: 453-00039 on-board PCB antenna performance (Antenna Gain and S11 – whilst 453-00039 module sitting on Devboard 453-00039-K1)

## 6 HARDWARE INTEGRATION SUGGESTIONS

### 6.1 Circuit

The BL653 is easy to integrate, requiring no external components on your board apart from those which you require for development and in your end application.

The following are suggestions for your design for the best performance and functionality.

Checklist (for Schematic):

- **BL653 power supply options:**

**Option 1** – Normal voltage power supply mode entered when the external supply voltage is connected to both the VDD and VDDH pins (so that VDD equals VDD\_HV). Connect external supply within range 1.7V to 3.6V range to BL653 VDD and VDD\_HV pins.

OR

**Option 2** – High voltage mode power supply mode (using BL653 VDD\_HV pin) entered when the external supply voltage in ONLY connected to the VDDH pin and the VDD pin is not connected to any external voltage supply. Connect external supply within range 2.5V to 5.5V range to BL653 VDD\_HV pin. BL653 VDD pin left unconnected.

In High Voltage mode (VDD\_HV), No external current draw (from VDD pin) is allowed (limitation of nRF52833 chipset).

For either option, if you use USB interface then the BL653 VBUS pin must be connected to external supply within the range 4.35V to 5.5V. When using the BL653 VBUS pin, you MUST externally fit a 4.7uF to ground.

**Note:** To avoid surpassing the maximum die temperature (110 °C), it is important to minimize current consumption when operating in the extended operating temperature conditions (+85 °C to +105°C). It is therefore recommended to use the module device on Normal Voltage mode with DCDC (REG1) enabled.

External power source should be within the operating range, rise time and noise/ripple specification of the BL653. Add decoupling capacitors for filtering the external source. Power-on reset circuitry within BL653 series module incorporates brown-out detector, thus simplifying your power supply design. Upon application of power, the internal power-on reset ensures that the module starts correctly.

- **VDD and coin-cell operation**

With a built-in DCDC (operating range 1.7V to 3.6V), that reduces the peak current required from a coin-cell, making it easier to use with a coin-cell.

▪ **AIN (ADC) and SIO pin IO voltage levels**

BL653 SIO voltage levels are at VDD. Ensure input voltage levels into SIO pins are at VDD also (if VDD source is a battery whose voltage will drop). Ensure ADC pin maximum input voltage for damage is not violated.

▪ **AIN (ADC) impedance and external voltage divider setup**

If you need to measure with ADC a voltage higher than 3.6V, you can connect a high impedance voltage divider to lower the voltage to the ADC input pin.

▪ **JTAG (SWD)**

This is REQUIRED as Nordic SDK applications can only be loaded using the SWD (JTAG) (*smartBASIC* firmware can be loaded using the JTAG as well as the UART).

We recommend that you use JTAG (2-wire interface) to handle future BL653 module firmware upgrades. You MUST wire out the JTAG (2-wire interface) on your host design (see Figure 7, where four lines should be wired out, namely SWDIO, SWDCLK, GND and VCC). Firmware upgrades can still be performed over the BL653 UART interface, but this is slower (60 seconds using UART vs. 10 seconds when using JTAG) than using the BL653 JTAG (2-wire interface). JTAG may be used if you intend to use Flash Cloning during production to load *smartBASIC* scripts.

▪ **UART**

Required for loading your *smartBASIC* application script during development (or for subsequent firmware upgrades (except JTAG for FW upgrades and/or Flash Cloning of the *smartBASIC* application script). Add connector to allow interfacing with UART via PC (UART-RS232 or UART-USB).

▪ **UART\_RX and UART\_CTS**

SIO\_08 (alternative function UART\_RX) is an input, set with internal weak pull-up (in firmware). The pull-up prevents the module from going into deep sleep when UART\_RX line is idling.

SIO\_07 (alternative function UART\_CTS) is an input, set with internal weak pull-down (in firmware). This pull-down ensures the default state of the UART\_CTS will be asserted which means can send data out of the UART\_TX line. Laird Connectivity recommends that UART\_CTS be connected.

▪ **nAutoRUN pin and operating mode selection**

nAutoRUN pin needs to be externally held high or low to select between the two BL653 operating modes at power-up:

- Self-contained Run mode (nAutoRUN pin held at 0V).
- Interactive / development mode (nAutoRUN pin held at VDD).

Make provision to allow operation in the required mode. Add jumper to allow nAutoRUN pin to be held high or low (BL653 has internal 13K pull-down by default) OR driven by host GPIO.

▪ **I2C**

It is essential to remember that pull-up resistors on both I2C\_SCL and I2C\_SDA lines are not provided in the BL653 module and MUST be provided external to the module as per I2C standard.

▪ **SPI**

Implement SPI chip select using any unused SIO pin within your *smartBASIC* application script or Nordic application then SPI\_CS is controlled from the software application allowing multi-dropping.

▪ **SIO pin direction**

BL653 modules shipped from production with *smartBASIC* FW, all SIO pins (with default function of DIO) are mostly digital inputs (see Pin Definitions Table2). Remember to change the direction SIO pin (in your *smartBASIC* application script) if that particular pin is wired to a device that expects to be driven by the BL653 SIO pin configured as an output. Also, these SIO pins have the internal pull-up or pull-down resistor-enabled by default in firmware (see Pin Definitions Table 2). This was done to avoid floating inputs, which can cause current consumption in low power modes (e.g. StandbyDoze) to drift with time. You can disable the PULL-UP or Pull-down through their *smartBASIC* application.

---

**Note:** Internal pull-up, pull down takes current from VDD.

---

▪ **SIO\_02 pin and OTA *smartBASIC* application download feature**

SIO\_02 is an input, set with internal pull-down (in FW). Refer to latest firmware release documentation on how SIO\_02 is used for Over the Air *smartBASIC* application download feature. The SIO\_02 pin must be pulled high externally to enable



the feature. Decide if this feature is required in production. When SIO\_02 is high, ensure nAutoRun is NOT high at same time; otherwise you cannot load the *smartBASIC* application script.

#### ▪ **NFC antenna connector**

To make use of the Laird Connectivity flexi-PCB NFC antenna, fit connector:

- Description – FFC/FPC Connector, Right Angle, SMD/90d, Dual Contact, 1.2 mm Mated Height
- Manufacturer – Molex
- Manufacturers Part number – 512810594

Add tuning capacitors of 300 pF on NFC1 pin to GND and 300 pF on NFC2 pins to GND if the PCB track length is similar as development board.

#### ▪ **nRESET pin (active low)**

Hardware reset. Wire out to push button or drive by host.  
By default module is out of reset when power applied to VCC pins.

#### ▪ **Optional External 32.768kHz crystal**

If the optional external 32.768kHz crystal is needed then use a crystal that meets specification and add load capacitors whose values should be tuned to meet all specification for frequency and oscillation margin.

#### ▪ **SIO\_38 special function pin**

This is for future use by Laird Connectivity. It is currently a Do Not Connect pin if using the *smartBASIC* FW.

#### ▪ **BL653 module RF pad variant 453-00041**

If using the BL653 module RF pad variant (453-00041), **MUST** copy the 50-Ohms GCPW RF track design, **MUST** add series 2nH RF inductor (Murata LQG15HN2N0B02# or Murata LQG15HS2N0B02) and RF connector IPEX MHF4 Receptacle (MPN: 20449-001E) Detailed in the following section: **50-Ohms RF Trace and RF Match Series 2nH RF Inductor on Host PCB for BL653 RF Pad Variant (453-00041)**.

## 6.2 PCB Layout on Host PCB - General

### Checklist (for PCB):

- **MUST** locate BL653 module close to the edge of PCB (mandatory for the 453-00039 for on-board PCB trace antenna to radiate properly).
- Use solid GND plane on inner layer (for best EMC and RF performance).
- All module GND pins **MUST** be connected to host PCB GND.
- Place GND vias close to module GND pads as possible.
- Unused PCB area on surface layer can be flooded with copper but place GND vias regularly to connect the copper flood to the inner GND plane. If GND flood copper is on the bottom of the module, then connect it with GND vias to the inner GND plane.
- Route traces to avoid noise being picked up on VDD, VDDH, VBUS supply and AIN (analogue) and SIO (digital) traces.
- Ensure no exposed copper is on the underside of the module (refer to land pattern of BL653 development board).

## 6.3 PCB Layout on Host PCB for the 453-00039

### 6.3.1 Antenna Keep-Out on Host PCB

The 453-00039 has an integrated PCB trace antenna and its performance is sensitive to host PCB. It is critical to locate the 453-00039 on the edge of the host PCB (or corner) to allow the antenna to radiate properly. Refer to guidelines in section **PCB land pattern and antenna keep-out area for the 453-00039**. Some of those guidelines repeated below.

- Ensure there is no copper in the antenna keep-out area on any layers of the host PCB. Keep all mounting hardware and metal clear of the area to allow proper antenna radiation.
- For best antenna performance, place the 453-00039 module on the edge of the host PCB, preferably in the edge center.
- The BL653 development board has the 453-00039 module on the edge of the board (not in the corner). The antenna keep-out area is defined by the BL653 development board which was used for module development and antenna performance evaluation is shown in [Figure 9](#), where the antenna keep-out area is ~5 mm wide, ~39.95 mm long; with PCB dielectric (no copper) height ~1 mm sitting under the 453-00039 PCB trace antenna.

- The 453-00039 module on-board PCB trace antenna is tuned when the 453-00039 is sitting on development board (host PCB) with size of 125 mm x 85 mm x 1mm.
- A different host PCB thickness dielectric will have small effect on antenna.
- The antenna-keep-out defined in the [Host PCB Land Pattern and Antenna Keep-out for the 453-00039](#) section.
- Host PCB land pattern and antenna keep-out for the BL653 applies when the 453-00039 is placed in the edge of the host PCB preferably in the edge center. [Figure 9](#) shows an example.

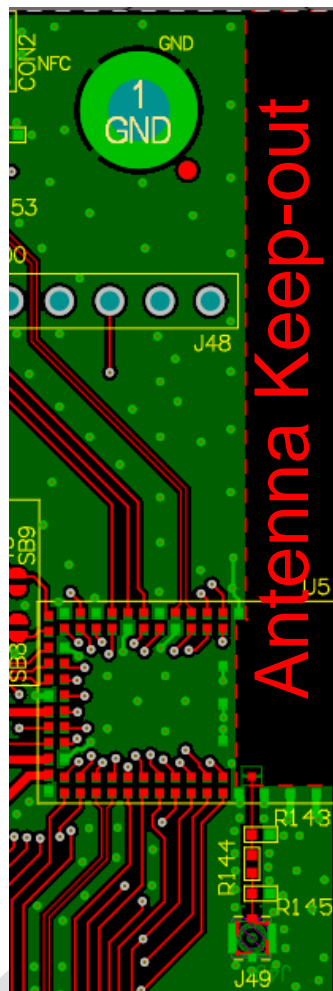

Figure 9: PCB trace Antenna keep-out area (shown in red), corner of the BL653 development board for the 453-00039 module.

#### Antenna Keep-out Notes:

**Note 1** | The BL653 module is placed on the edge, preferably edge centre of the host PCB.

**Note 2** | Copper cut-away on all layers in the *Antenna Keep-out* area under the 453-00039 on host PCB.

### 6.3.2 Antenna Keep-Out and Proximity to Metal or Plastic

#### Checklist (for metal /plastic enclosure):

- Minimum safe distance for metals without seriously compromising the antenna (tuning) is 40 mm top/bottom and 30 mm left or right.
- Metal close to the 453-00039 PCB trace monopole antenna (bottom, top, left, right, any direction) will have degradation on the antenna performance. The amount of that degradation is entirely system dependent, meaning you will need to perform some testing with your host application.
- Any metal closer than 20 mm will begin to significantly degrade performance (S11, gain, radiation efficiency).
- It is best that you test the range with a mock-up (or actual prototype) of the product to assess effects of enclosure height (and materials, whether metal or plastic).

## 6.4 50-Ohms RF Trace and RF Match Series 2nH RF Inductor on Host PCB for BL653 RF Pad Variant (453-00041)

To use an external antenna requires BL653 module variant with RF pad (453-00041) and 50-Ohm RF trace (GCPW, that is Grounded Coplanar Waveguide) from RF\_pad (pin72) of the module (BL653 453-00041) to RF antenna connector (IPEX MHF4) on host PCB. On this RF path, MUST use 2nH series RF inductor. BL653 module GND pin0 and GND pin66 used to support GCPW 50-Ohm RF trace.

#### Checklist for SCH

- MUST fit 2 nH RF inductor (R144) in series. RF inductor part number is Murata LQG15HN2N0B02# or Murata LQG15HS2N0B02# with 0402 body size.  
<https://www.murata.com/en-eu/products/productdetail.aspx?partno=LQG15HN2N0B02%23>  
<https://www.murata.com/en-eu/products/productdetail.aspx?partno=LQG15HS2N0B02%23>
- MUST fit RF connector IPEX MHF4 Receptacle (MPN: 20449-001E), <https://www.i-pex.com/product/mhf-4-smt#!>

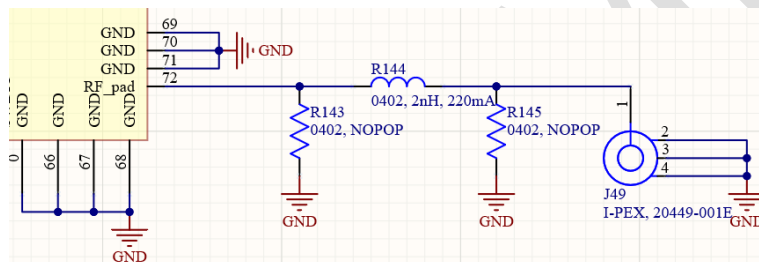
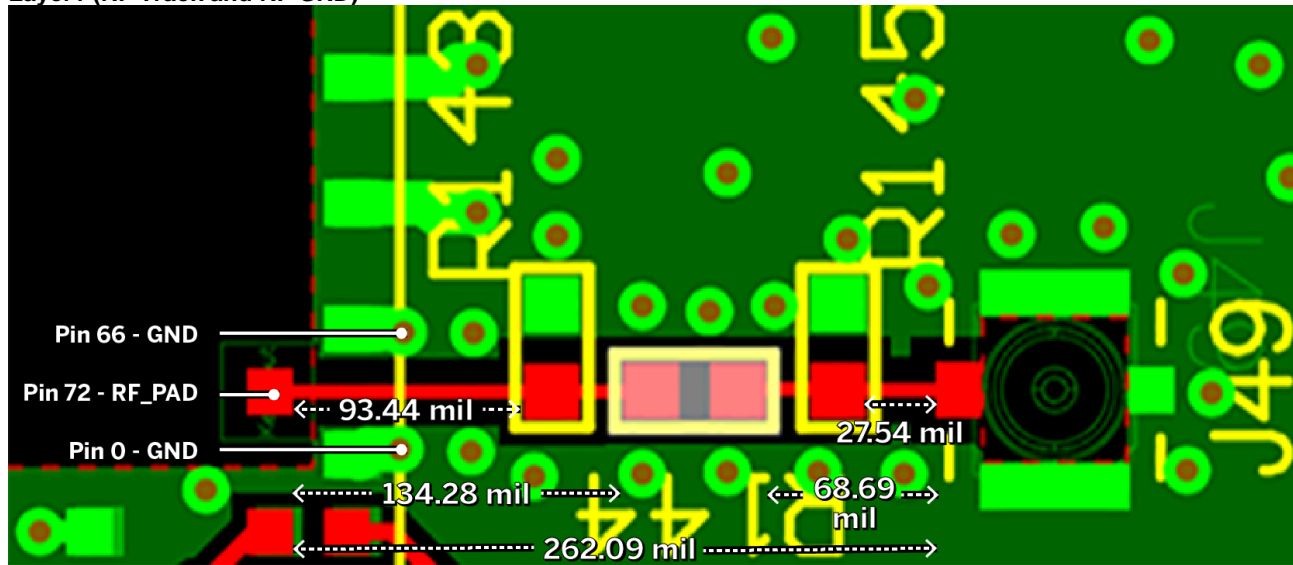

Figure 10: BL653 RF pad variant (453-00041) Host PCB 50-Ohm RF trace schematic with series 2nH inductor, RF connector



Layer1 (RF Track and RF GND)



Layer2 (RF GND) and Layer2 copper cut-out under RF connector

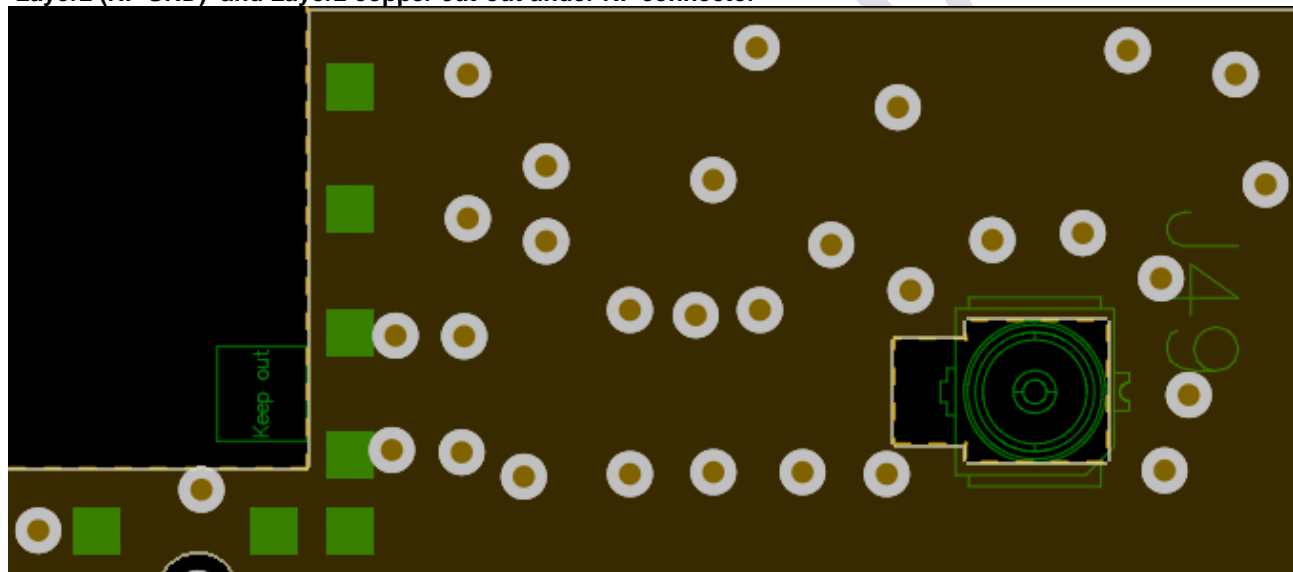
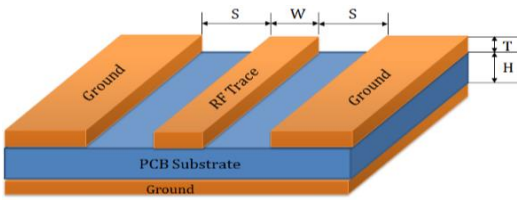

Figure 11: 50-Ohm RF trace design (Layer1 and Layer2) on BL653 development board (or host PCB) for use with BL653 (453-00041) module

Checklist for PCB:

- MUST use a 50-Ohm RF trace (GCPW, that is Grounded Coplanar Waveguide) from RF\_pad (pin72) of the module (BL653 453-00041) to RF antenna connector (IPEX MHF4) on host PCB.

To ensure regulatory compliance, MUST follow exactly the following considerations for 50-Ohms RF trace design and test verification:



	Thickness mil	
Solder Mask	0.4	Stack up for 50Ohms GCPW RF track.
Layer1 Copper 0.5oz (Note1)	0.7	
Prepreg	4	
Layer2 Copper 1oz	1.4	
Core 0.6mm	24	
Layer3 Copper 1oz	1.4	
Prepreg	4	
Layer4 Copper 0.5oz (Note1)	0.7	
Solder Mask	0.4	

**Note 1:** The plating (ENIG) above base 0.5z copper is not listed, but plating expected to be ENIG.

**Figure 12: BL653 development board PCB stack-up and L1 to L2 50-Ohms Grounded CPW RF trace design**

- The 50-Ohms RF trace design MUST be Grounded Coplanar Waveguide (GCPW) with
  - Layer1 RF track width (W) of 6.5mil and
  - Layer1 gap (G) to GND of 10mil and where the
  - Layer1 to Layer 2 dielectric thickness (H) MUST be 4mil.
  - Further the Layer1 base copper must be 0.5-ounce base copper (that is 0.7mil) plus the plating and
  - Layer1 MUST be covered by solder mask.
- The 50-Ohms RF trace design MUST follow the PCB stack-up shown in Figure 12. (Layer1 to Layer2 thickness MUST be identical to the BL653 development board).
- The 50-Ohms RF trace should be a controlled-impedance trace e.g. ±10%.
- The 50-Ohms RF trace length MUST be identical (as seen in Figure 12) (TBD 6.7 mm) to that on the BL653 development board from BL653 module RF pad (pin72) to the RF connector IPEX MHF4 Receptable (MPN: 20449-001E).
- Place GND vias regularly spaced either side of 50-Ohms RF trace to form GCPW (Grounded coplanar waveguide) transmission line as shown in Figure12 and use BL653 module GND pin0 and GND pin66.
- Cut away copper on Layer2 GND layer under the RF connector IPEX MHF4 Receptable, as seen in Figure 12. This is to reduce RF detuning the 50Ohms of the RF connector (J49) when it sits on the PCB.
- Cut away copper on Layer2 GND layer under the BL653 module RF pad (pin72), identical to the BL653 development board as seen in Figure 12.
- Use spectrum analyzer to confirm the radiated (and conducted) signal is within the certification limit.

## 6.5 External Antenna Integration with 453-00041

Please refer to the regulatory sections for [FCC](#), [IC](#), [CE](#), RCM, KC, and [Japan](#) for details of use of BL653-with external antennas in each regulatory region.

The BL653 family has been designed to operate with the below external antennas (with a maximum gain of 2.0 dBi). The required antenna impedance is 50 ohms. See [Table 24](#). External antennas improve radiation efficiency.

**Table 24: External antennas for the BL653**

Manufacturer	Model	Laird Connectivity Part Number	Type	Connector	Peak Gain	
					2400-2500 MHz	2400-2480 MHz
Laird Connectivity	NanoBlue	EBL2400A1-10MH4L	PCB Dipole	IPEX MHF4	2 dBi	-
Laird Connectivity	FlexPIFA	001-0022	Patch	IPEX MHF4	-	2 dBi
Mag.Layers	EDA-8709-2G4C1-B27-CY	0600-00057	Dipole	IPEX MHF4	2 dBi	-
Laird Connectivity	mFlexPIFA	EFA2400A3S-10MH4L	PIFA	IPEX MHF4	-	2 dBi
Laird Connectivity	Laird Connectivity NFC	0600-00061	NFC	N/A	-	-
Laird Connectivity	BL653 PCB printed antenna	NA	Printed PCB	N/A	0 dBi	-

PRELIMINARY

## 7 MECHANICAL DETAILS

### 7.1 BL653 Mechanical Details

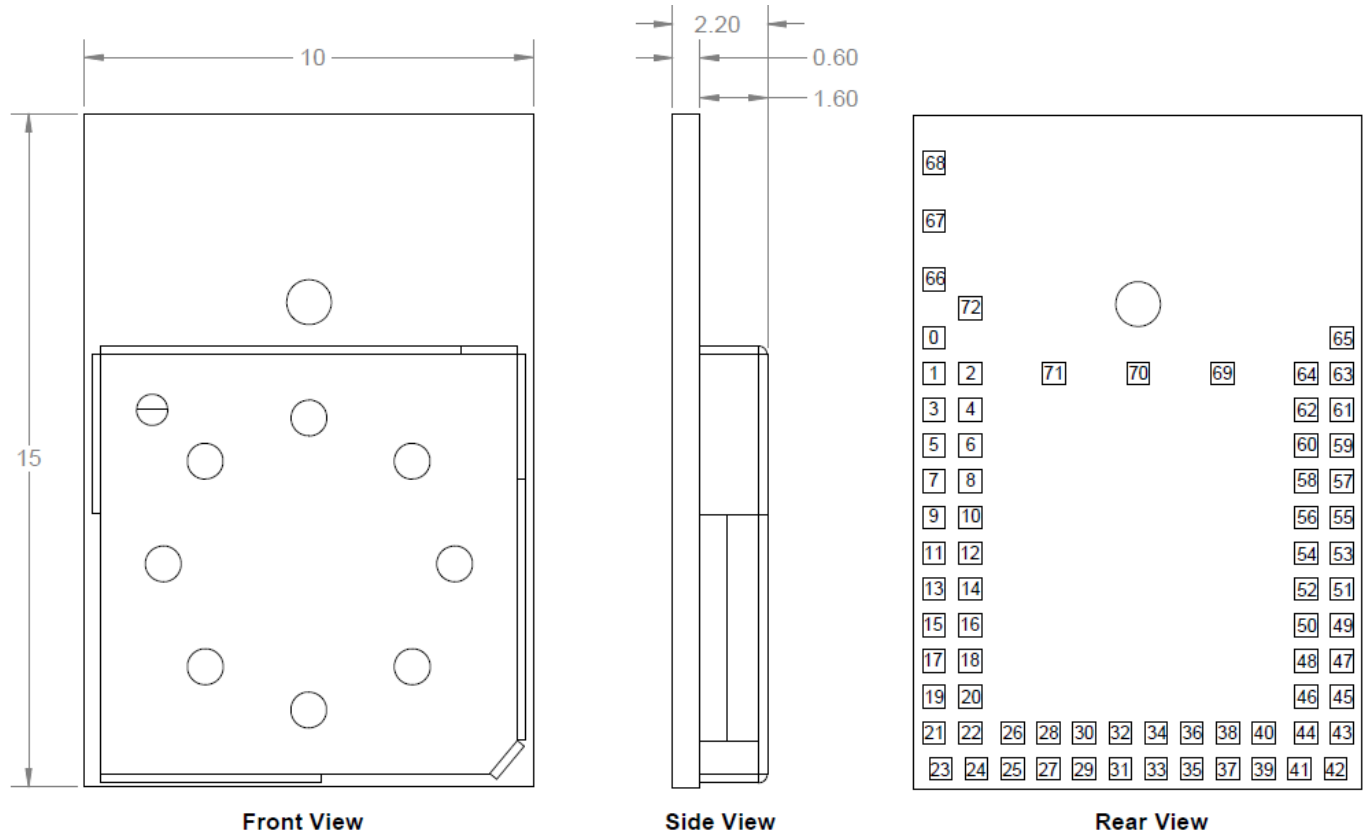

#### Tolerances

**Board Outline:  $\pm 0.13\text{mm}$**   
**Board Height:  $\pm 0.15\text{mm}$**

Figure 13: BL653 mechanical drawings

Development Kit Schematics can be found in the software downloads tab of the [BL653 product page](#).

## 7.2 Host PCB Land Pattern and Antenna Keep-out for the 453-00039

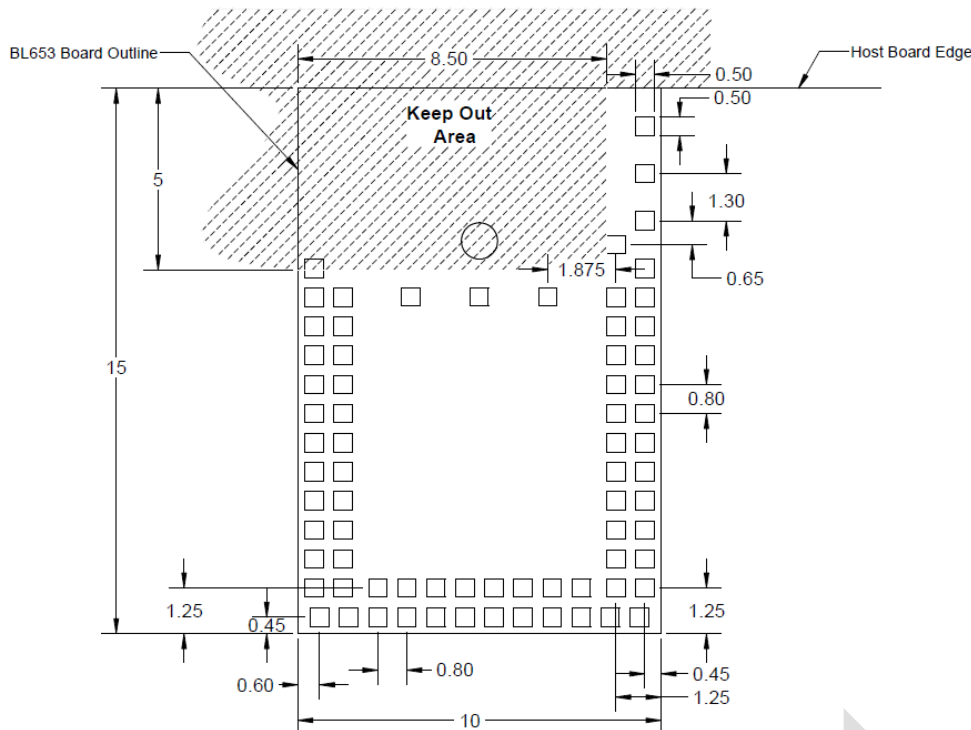

**Figure 14: Land pattern and Keep-out for the 453-00039**

All dimensions are in millimeters.

### Host PCB Land Pattern and Antenna Keep-out for the 453-00039 Notes:

- |               |  |
|---------------|--|
| <b>Note 1</b> | Ensure there is no copper in the antenna 'keep out area' on any layers of the host PCB. Also keep all mounting hardware or any metal clear of the area (Refer to 6.3.2) to reduce effects of proximity detuning the antenna and to help antenna radiate properly.  |
| <b>Note 2</b> | For the best on-board antenna performance, the module 453-00039 MUST be placed on the edge of the host PCB and preferably in the edge centre and host PCB, the antenna "Keep Out Area" is extended (see Note 4).   |
| <b>Note 3</b> | BL653 development board has the 453-00039 placed on the edge of the PCB board (and not in corner) for that the Antenna keep out area is extended down to the corner of the development board, see section <a href="#">PCB Layout on Host PCB for the 453-00039</a> , Figure 14. This was used for module development and antenna performance evaluation. |
| <b>Note 4</b> | Ensure that there is no exposed copper under the module on the host PCB.   |
| <b>Note 5</b> | You may modify the PCB land pattern dimensions based on their experience and/or process capability.  |

## 8 APPLICATION NOTE FOR SURFACE MOUNT MODULES

### 8.1 Introduction

Laird Connectivity's surface mount modules are designed to conform to all major manufacturing guidelines. This application note is intended to provide additional guidance beyond the information that is presented in the User Manual. This Application Note is considered a living document and will be updated as new information is presented.

The modules are designed to meet the needs of several commercial and industrial applications. They are easy to manufacture and conform to current automated manufacturing processes.

### 8.2 Shipping

#### 8.2.1 Tape and Reel Package Information

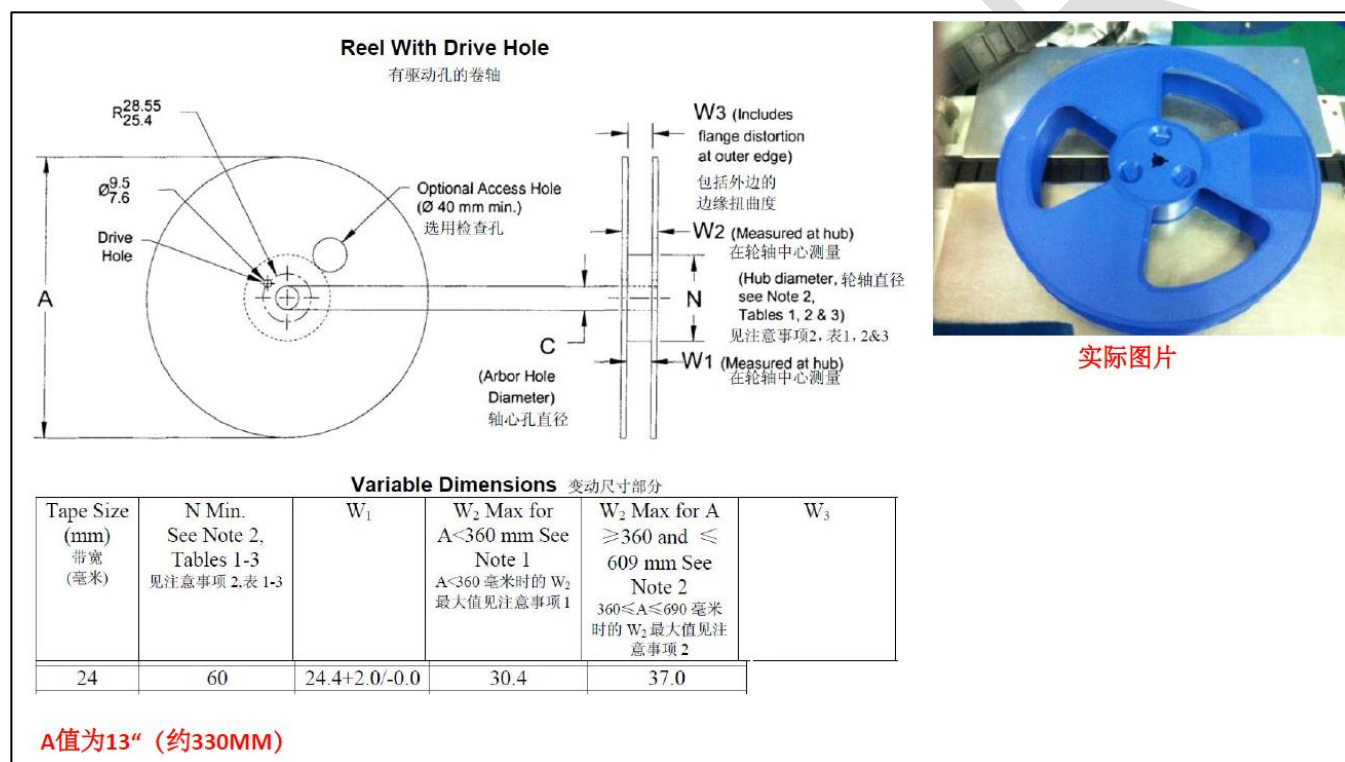
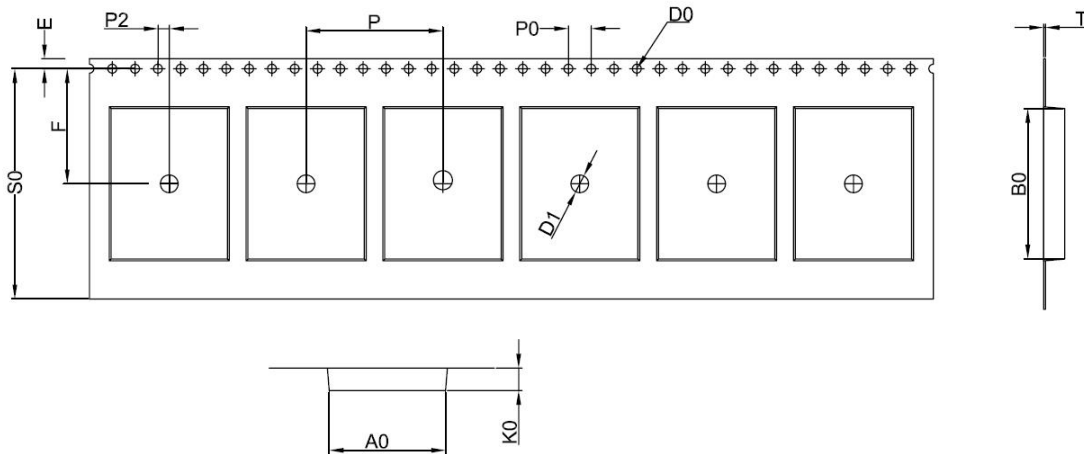

Figure 15: Reel specifications

ITRM	W	A0	B0	K0	K1	P	F	E	S0	D0	D1	P0	P2	T	13" 环保卷轮	
DIM	24.00	10.30	14.30	2.40	--	16.00	11.50	1.75	22.25	1.50	1.50	4.00	2.00	0.35	长度/盘	元件/盘
TOL	+0.30 -0.30	+0.30 -0.0	+0.30 -0.0	+0.20 -0.00	+0.10 -0.10	+0.10 -0.10	+0.10 -0.10	+0.10 -0.10	+0.10 -0.10	+0.10 -0.00	+0.10 -0.00	+0.10 -0.10	+0.10 -0.10	+0.05 -0.05	25M	1000pcs



- 备注：  
 (1) 任意10个精轮孔的累计误差不超过 $\pm 0.20\text{mm}$ 。  
 (2) 载带长度方向100mm 距离的非平行度不可超过1mm。 超过250mm 不计算累计误差。  
 (3) 非指明公差范围为： $\pm 0.20\text{mm}$ 。  
 (4) A0, B0 为型腔内底部尺寸, K0 为内腔尺寸。  
 (5) 材料厚度T 以在载带边缘测量为角, 须打中孔  
 (6) 材质黑色防静电。

Title <b>BL652 Shipping Tape</b>		
P/N: 45V728-00100	Rev 1	
Drawn by <b>wzr</b>	Date 7-Jul-2016	Sheet <b>1/1</b>

Figure 16: Tape specifications

There are 1,000 x BL653 modules taped in a reel (and packaged in a pizza box) and five boxes per carton (5000 modules per carton). Reel, boxes, and carton are labeled with the appropriate labels. See [Carton Contents](#) for more information.

## 8.2.2 Carton Contents

The following are the contents of the carton shipped for the BL653 modules.

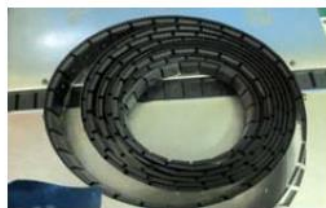

PCBA: 5000 pcs/ctn



Tape: 1000 pcs PCBA/roll, 5 rolls/ctn



Reel: 5 pcs/ctn

Bag: 5 pcs/ctn



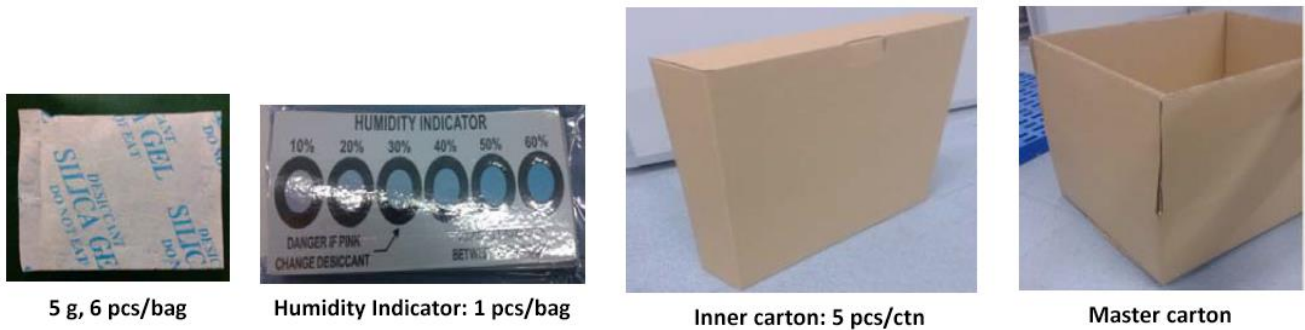

Figure 17: Carton contents for the BL653

### 8.2.3 Packaging Process

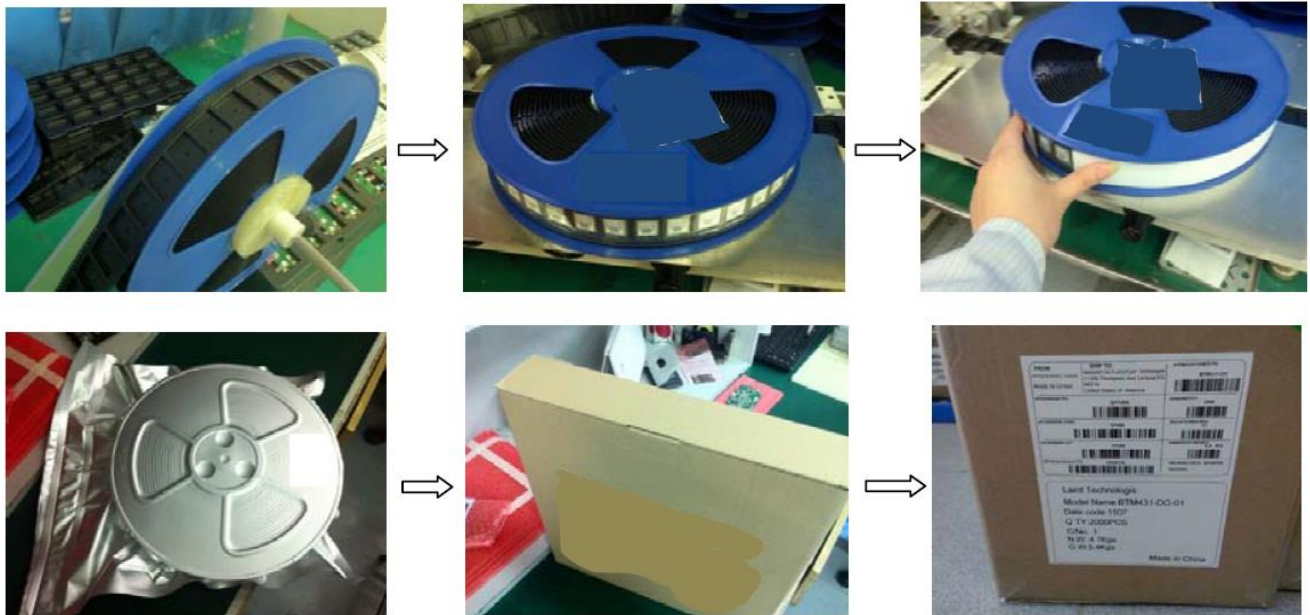

Figure 18: BL653 packaging process

### 8.2.4 Labeling

The following labels are located on the antistatic bag:



Figure 19: Antistatic bag labels

The following package label is located on both sides of the master carton:

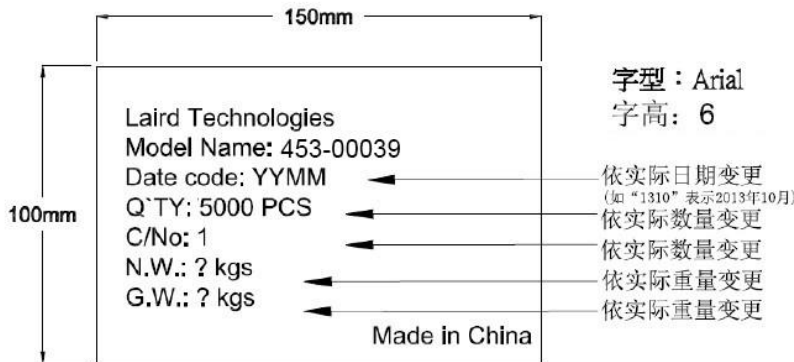

Figure 20: Master carton package label

The following is the packing slip label:

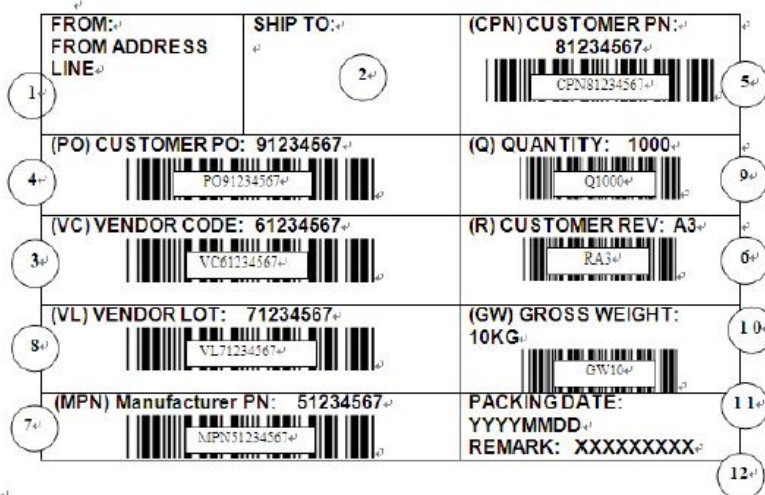

Figure 21: Packing slip label

### 8.3 Reflow Parameters

Prior to any reflow, it is important to ensure the modules were packaged to prevent moisture absorption. New packages contain desiccant (to absorb moisture) and a humidity indicator card to display the level maintained during storage and shipment. If directed to *bake units* on the card, see Table 25 and follow instructions specified by IPC/JEDEC J-STD-033. A copy of this standard is available from the JEDEC website: <http://www.jedec.org/sites/default/files/docs/jstd033b01.pdf>

Any modules not manufactured before exceeding their floor life should be re-packaged with fresh desiccant and a new humidity indicator card. Floor life for MSL (Moisture Sensitivity Level) 4 devices is 72 hours in ambient environment  $\leq 30^{\circ}\text{C}/60\%\text{RH}$ .

Table 25: Recommended baking times and temperatures

MSL	125°C		90°C/≤5%RH		40°C/≤5%RH	
	Baking Temp.		Baking Temp.		Baking Temp.	
	Saturated @ 30°C/85%	Floor Life Limit + 72 hours @ 30°C/60%	Saturated @ 30°C/85%	Floor Life Limit + 72 hours @ 30°C/60%	Saturated @ 30°C/85%	Floor Life Limit + 72 hours @ 30°C/60%
4	11 hours	7 hours	37 hours	23 hours	15 days	9 days

Laird Connectivity surface mount modules are designed to be easily manufactured, including reflow soldering to a PCB. Ultimately it is the responsibility of the customer to choose the appropriate solder paste and to ensure oven temperatures during reflow meet the requirements of the solder paste. Laird Connectivity surface mount modules conform to J-STD-020D1 standards for reflow temperatures.

**Important:** During reflow, modules should not be above 260° and not for more than 30 seconds. In addition, we recommend that the BL653 module **does not** go through the reflow process more than one time; otherwise the BL653 internal component soldering may be impacted.

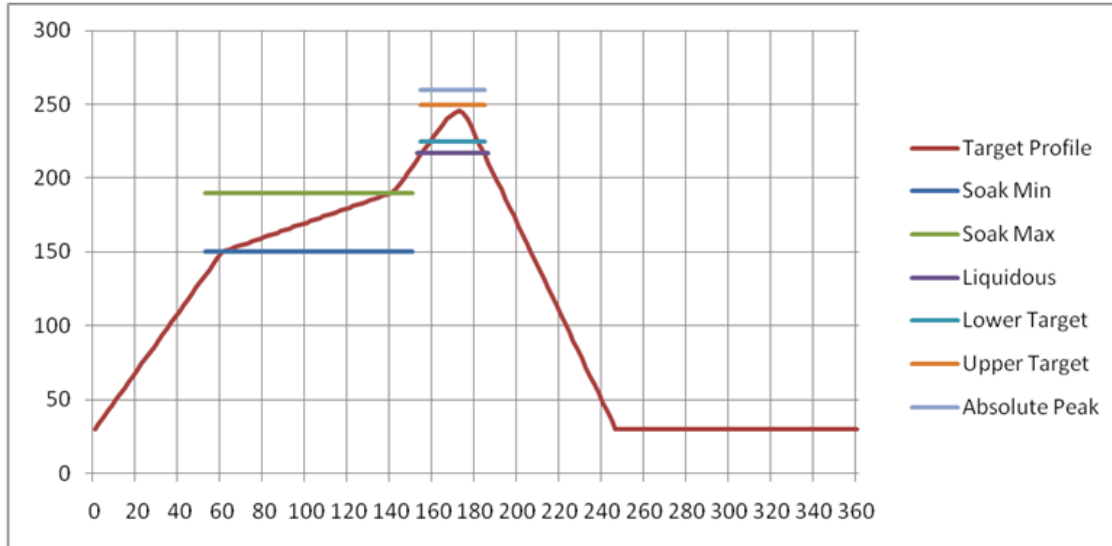

Figure 22: Recommended reflow temperature

Temperatures should not exceed the minimums or maximums presented in Table 26.

Table 26: Recommended maximum and minimum temperatures

Specification	Value	Unit
Temperature Inc./Dec. Rate (max)	1~3	°C / Sec
Temperature Decrease rate (goal)	2-4	°C / Sec
Soak Temp Increase rate (goal)	.5 - 1	°C / Sec
Flux Soak Period (Min)	70	Sec
Flux Soak Period (Max)	120	Sec
Flux Soak Temp (Min)	150	°C
Flux Soak Temp (max)	190	°C
Time Above Liquidous (max)	70	Sec
Time Above Liquidous (min)	50	Sec
Time In Target Reflow Range (goal)	30	Sec
Time At Absolute Peak (max)	5	Sec
Liquidous Temperature (SAC305)	218	°C
Lower Target Reflow Temperature	240	°C
Upper Target Reflow Temperature	250	°C
Absolute Peak Temperature	260	°C

## 9 FCC AND IC REGULATORY STATEMENTS

Model	US/FCC	Canada/IC
453-00039	SQGBL653	3147A-BL653
453-00041	SQGBL653	3147A-BL653

The 453-00039 and the 453-00041 hold full modular approvals. The OEM must follow the regulatory guidelines and warnings listed below to inherit the modular approval.

Part #	Form Factor	Tx Outputs	Antenna
453-00039	Surface Mount	8 dBm	PCB Trace
453-00041	Surface Mount	8 dBm	IPEX MHF4

### 9.1 Antenna Information

The BL653 family has been designed to operate with the antennas listed below with a maximum gain of 2 dBi. The required antenna impedance is 50 ohms.

Manufacturer	Model	Laird Connectivity Part Number	Type	Connector	Peak Gain	
					2400-2500 MHz	2400-2480 MHz
Laird Connectivity	NanoBlue	EBL2400A1-10MH4L	PCB Dipole	IPEX MHF4	2 dBi	-
Laird Connectivity	FlexPIFA	001-0022	PCB Dipole	IPEX MHF4	-	2 dBi
Mag.Layers	EDA-8709-2G4C1-B27-CY	0600-00057	Dipole	IPEX MHF4	2 dBi	-
Laird Connectivity	mFlexPIFA	EFA2400A3S-10MH4L	PIFA	IPEX MHF4	-	2 dBi
Laird Connectivity	Laird Connectivity NFC	0600-00061	NFC	N/A	-	-
Laird Connectivity	BL653 PCB printed antenna	NA	Printed PCB	N/A	0 dBi	-

**Note:** The OEM is free to choose another vendor's antenna of like type and equal or lesser gain as an antenna appearing in the table and still maintain compliance. Reference FCC Part 15.204(c)(4) for further information on this topic.

To reduce potential radio interference to other users, the antenna type and gain should be chosen so that the equivalent isotropic radiated power (EIRP) is not more than that permitted for successful communication.

### 9.2 Power Exposure Information

Federal Communication Commission (FCC) Radiation Exposure Statement:

This EUT complies with SAR for general population/uncontrolled exposure limits in FCC Part 1.1307, Part. 1310 and FCC KDB 447498 – RF Exposure Procedures and Equipment Authorization Policies for Mobile and Portable Devices.

This transceiver must not be co-located or operating in conjunction with any other antenna, transmitter, or external amplifiers. Further testing/evaluation of the end product will be required if the OEM's device violates any of these requirements.

The BL653 is fully approved for mobile and portable applications.

## 9.3 OEM Responsibilities

**WARNING:** The OEM must ensure that FCC labelling requirements are met. This includes a clearly visible label on the outside of the OEM enclosure specifying the appropriate Laird Connectivity FCC identifier for this product.

**Contains FCC ID: SQGBL653**

If the size of the end product is larger than 8x10cm, then the following FCC part 15.19 statement must also be available on visible on outside of device:

*The enclosed device complies with Part 15 of the FCC Rules. Operation is subject to the following two conditions: (1) This device may not cause harmful interference, and (2) This device must accept any interference received, including interference that may cause undesired operation.*

Label and text information should be in a size of type large enough to be readily legible, consistent with the dimensions of the equipment and the label. However, the type size for the text is not required to be larger than eight points.

**CAUTION:** The OEM should have their device which incorporates the BL653 tested by a qualified test house to verify compliance with FCC Part 15 Subpart B limits for unintentional radiators.

**CAUTION:** Any changes or modifications not expressly approved by Laird Connectivity could void the user's authority to operate the equipment.

## 9.4 Federal Communication Commission Interference Statement

This equipment was tested and found compliant with the limits for a Class B digital device, pursuant to Part 15 of the FCC Rules. These limits are designed to provide reasonable protection against harmful interference in a residential installation. This equipment generates, uses and can radiate radio frequency energy and, if not installed and used in accordance with the instructions, may cause harmful interference to radio communications. However, there is no guarantee that interference will not occur in a particular installation. If this equipment does cause harmful interference to radio or television reception, which can be determined by turning the equipment off and on, the user is encouraged to try to correct the interference by one of the following measures:

- Reorient or relocate the receiving antenna.
- Increase the separation between the equipment and receiver.
- Connect the equipment into an outlet on a circuit different from that to which the receiver is connected.
- Consult the dealer or an experienced radio/TV technician for help.

**FCC Caution:** Any changes or modifications not expressly approved by the party responsible for compliance could void the user's authority to operate this equipment.

This device complies with Part 15 of the FCC Rules. Operation is subject to the following two conditions: (1) This device may not cause harmful interference, and (2) this device must accept any interference received, including interference that may cause undesired operation.

**IMPORTANT NOTE:**

**FCC Radiation Exposure Statement:**

This product complies with the US portable RF exposure limit set forth for an uncontrolled environment and is safe for intended operation as described in this manual. The further RF exposure reduction can be achieved if the product can be kept as far as possible from the user body or set the device to lower output power if such function is available.

Country Code selection feature to be disabled for products marketed to the US/CANADA.

This equipment complies with FCC radiation exposure limits set forth for an uncontrolled environment. This equipment should be installed and operated with a minimum distance of 20 centimeters between the radiator and your body.

This transmitter must not be co-located or operating in conjunction with any other antenna or transmitter.

**Integration Instructions for Host Product Manufacturers**

**Applicable FCC rules for this module:** FCC Part 15.247



### Summarization of Specific Operational Use Conditions

This device is intended only for OEM integrators under the following condition:

- The transmitter module may not be co-located with any other transmitter or antenna

As long as the condition above is met, further transmitter test is not required. However, the OEM integrator is still responsible for testing their end-product for any additional compliance requirements required with this module installed.

**IMPORTANT NOTE:** In the event that these conditions cannot be met (for example certain laptop configurations or co-location with another transmitter), then the FCC authorization is no longer considered valid and the FCC ID cannot be used on the final product. In these circumstances, the OEM integrator is responsible for re-evaluating the end product (including the transmitter) and obtaining a separate FCC authorization. The OEM integrator must be aware not to provide information to the end user regarding how to install or remove this RF module in the user's manual of the end product which integrates this module.

The end user manual shall include all required regulatory information/warning as shown in this manual.

### Limited Module Procedures

Not applicable

### Trace Antenna Designs

Not applicable

### RF Exposure Considerations

Co-located issue shall be met as mentioned in the **Summarization of Specific Operational Use Conditions** section.

Product manufacturer shall provide the following text in the end-product manual:

#### **FCC Radiation Exposure Statement**

This product complies with the US portable RF exposure limit set forth for an uncontrolled environment and is safe for intended operation as described in this manual. The further RF exposure reduction can be achieved if the product can be kept as far as possible from the user body or set the device to lower output power if such function is available.

A 20-centimeter separation distance and co-located issues shall be met as mentioned in the in **Summarization of Specific Operational Use Conditions** section.

The manufacturer shall provide the following text in the end-product manual:

*This equipment complies with FCC radiation exposure limits set forth for an uncontrolled environment. This equipment should be installed and operated with minimum distance of 20 centimeters between the radiator and your body.*

### Antennas

Manufacturer	Model	Laird Part Number	Type	Connector	2400-2500 MHz	2400-2480 MHz
Laird	NanoBlue	EBL2400A1-10MH4L	PCB Dipole	IPEX MHF4	2 dBi	
Laird	FlexPIFA	001-0022	PCB Dipole	IPEX MHF4		2 dBi
Mag. Layers	EDA-8709-2G4C1-B27-CY	0600-00057	Dipole	IPEX MHF4	2 dBi	
Laird	mFlexPIFA	EFA2400A3S-10MH4L	PIFA	IPEX MHF4		2 dBi
Laird	Laird NFC	0600-00061	NFC	N/A		
Laird	BL653-SA PCB printed antenna	N/A	Printed PCB	N/A	1.28 dBi	

### Label and Compliance Information

Product manufacturers must provide a physical or e-label with the finished product that state the following:

**Contains FCC ID: SQGBL653**

## Information on Test Modes and Additional Testing Requirements

Test tool: BleDtmRfTool shall be used to set the module to transmit continuously.

### Additional Testing, Part 15 Subpart B Disclaimer

The module is only FCC authorized for the specific rule parts listed on the grant, and that the host product manufacturer is responsible for compliance to any other FCC rules that apply to the host not covered by the modular transmitter grant of certification. The final host product still requires Part 15 Subpart B compliance testing with the modular transmitter installed.

## 9.5 Industry Canada Statement

This device contains licence-exempt transmitter(s)/receiver(s) that comply with Innovation, Science and Economic Development Canada's licence-exempt RSS(s). Operation is subject to the following two conditions:

- (1) This device may not cause interference
- (2) This device must accept any interference, including interference that may cause undesired operation of the device

*L'émetteur/récepteur exempt de licence contenu dans le présent appareil est conforme aux CNR d'Innovation, Sciences et Développement économique Canada applicables aux appareils radio exempts de licence. L'exploitation est autorisée aux deux conditions suivantes :*

- (1) *L'appareil ne doit pas produire de brouillage;*
- (2) *L'appareil doit accepter tout brouillage radioélectrique subi, même si le brouillage est susceptible d'en compromettre le fonctionnement.*

This radio transmitter (IC: 3147A-BL653) has been approved by Innovation, Science and Economic Development Canada to operate with the antenna types listed below, with the maximum permissible gain indicated. Antenna types not included in this list that have a gain greater than the maximum gain indicated for any type listed are strictly prohibited for use with this device.

Le présent émetteur radio (IC: 3147A-BL653) a été approuvé par Innovation, Sciences et Développement économique Canada pour fonctionner avec les types d'antenne énumérés ci-dessous et ayant un gain admissible maximal. Les types d'antenne non inclus dans cette liste, et dont le gain est supérieur au gain maximal indiqué pour tout type figurant sur la liste, sont strictement interdits pour l'exploitation de l'émetteur.

Manufacturer	Model	Laird Part Number	Type	Connector	2400-2500 MHz	2400-2480 MHz
Laird	NanoBlue	EBL2400A1-10MH4L	PCB Dipole	IPEX MHF4	2 dBi	
Laird	FlexPIFA	001-0022	PCB Dipole	IPEX MHF4		2 dBi
Mag. Layers	EDA-8709-2G4C1-B27-CY	0600-00057	Dipole	IPEX MHF4	2 dBi	
Laird	mFlexPIFA	EFA2400A3S-10MH4L	PIFA	IPEX MHF4		2 dBi
Laird	Laird NFC	0600-00061	NFC	N/A		
Laird	BL653-SA PCB printed antenna	N/A	Printed PCB	N/A	1.28 dBi	

### Radiation Exposure Statement:

This equipment complies with Canada radiation exposure limits set forth for an uncontrolled environment. This equipment should be installed and operated with minimum distance 20cm between the radiator & your body.

### Déclaration d'exposition aux radiations:

Cet équipement est conforme Canada limites d'exposition aux radiations dans un environnement non contrôlé. Cet équipement doit être installé et utilisé à distance minimum de 20cm entre le radiateur et votre corps.

This device is intended only for OEM integrators under the following condition:

- 1) The transmitter module may not be co-located with any other transmitter or antenna.

As long as the condition above is met, further transmitter test will not be required. However, the OEM integrator is still responsible for testing their end-product for any additional compliance requirements required with this module installed.

Cet appareil est conçu uniquement pour les intégrateurs OEM dans les conditions suivantes:



1) Le module émetteur peut ne pas être coïmplanté avec un autre émetteur ou antenne.

Tant que les 1 condition ci-dessus sont remplies, des essais supplémentaires sur l'émetteur ne seront pas nécessaires. Toutefois, l'intégrateur OEM est toujours responsable des essais sur son produit final pour toutes exigences de conformité supplémentaires requis pour ce module installé.

---

**IMPORTANT NOTE:** In the event that these conditions cannot be met (for example certain laptop configurations or co-location with another transmitter), then the Canada authorization is no longer considered valid and the IC ID cannot be used on the final product. In these circumstances, the OEM integrator will be responsible for re-evaluating the end product (including the transmitter) and obtaining a separate Canada authorization.

---

---

**NOTE IMPORTANTE:** Dans le cas où ces conditions ne peuvent être satisfaites (par exemple pour certaines configurations d'ordinateur portable ou de certaines co-localisation avec un autre émetteur), l'autorisation du Canada n'est plus considéré comme valide et l'ID IC ne peut pas être utilisé sur le produit final. Dans ces circonstances, l'intégrateur OEM sera chargé de réévaluer le produit final (y compris l'émetteur) et l'obtention d'une autorisation distincte au Canada.

---

#### End Product Labeling

The final end product must be labeled in a visible area with the following: "Contains IC:3147A-BL653.

#### Plaque signalétique du produit final

Le produit final doit être étiqueté dans un endroit visible avec l'inscription suivante: "Contient des IC:3147A-BL653.

#### Manual Information to the End User

The OEM integrator has to be aware not to provide information to the end user regarding how to install or remove this RF module in the user's manual of the end product which integrates this module.

The end user manual shall include all required regulatory information/warning as show in this manual.

#### Manuel d'information à l'utilisateur final

L'intégrateur OEM doit être conscient de ne pas fournir des informations à l'utilisateur final quant à la façon d'installer ou de supprimer ce module RF dans le manuel de l'utilisateur du produit final qui intègre ce module.

Le manuel de l'utilisateur final doit inclure toutes les informations réglementaires requises et avertissements comme indiqué dans ce manuel.

## 10 JAPAN (MIC) REGULATORY

The BL653 is approved for use in the Japanese market. The part numbers listed below hold WW type certification. Refer to **ARIB-STD-T66** for further guidance on OEM's responsibilities.

Model	Certificate Number	Antenna
453-00039	201-180112	PCB Trace
453-00041	201-180112	IPEX MHF4

### 10.1 Antenna Information

The BL653 was tested with antennas listed below. The OEM can choose a different manufacturer's antenna but must make sure it is of same type and that the gain is lesser than or equal to the antenna that is approved for use.

Manufacturer	Model	Laird Connectivity Part Number	Type	Connector	Peak Gain	
					2400-2500 MHz	2400-2480 MHz
Laird Connectivity	NanoBlue	EBL2400A1-10MH4L	PCB Dipole	IPEX MHF4	2 dBi	-
Laird Connectivity	FlexPIFA	001-0022	PCB Dipole	IPEX MHF4	-	2 dBi
Mag.Layers	EDA-8709-2G4C1-B27-CY	0600-00057	Dipole	IPEX MHF4	2 dBi	-
Laird Connectivity	mFlexPIFA	EFA2400A3S-10MH4L	PIFA	IPEX MHF4	-	2 dBi
Laird Connectivity	Laird Connectivity NFC	0600-00061	NFC	N/A	-	-
Laird Connectivity	BL653 PCB printed antenna	NA	Printed PCB	N/A	0 dBi	-

## 11 CE REGULATORY

The 453-00039/453-00041 have been tested for compliance with relevant standards for the EU market. The 453-00041 module was tested with a 2 dBi antenna. The OEM can operate the 453-00041 module with any other type of antenna but must ensure that the gain does not exceed 2 dBi to maintain the Laird approval.

The OEM should consult with a qualified test house before entering their device into an EU member country to make sure all regulatory requirements have been met for their complete device.

Reference the Declaration of Conformities listed below for a full list of the standards that the modules were tested to. Test reports are available upon request.

### 11.1 Antenna Information

The antennas listed below were tested for use with the BL653. For CE mark countries, the OEM is free to use any manufacturer's antenna and type of antenna if the gain is less than or equal to the highest gain approved for use (2dBi) Contact a Laird Connectivity representative for more information regarding adding antennas.

Manufacturer	Model	Laird Connectivity Part Number	Type	Connector	Peak Gain	
					2400-2500 MHz	2400-2480 MHz
Laird Connectivity	NanoBlue	EBL2400A1-10MH4L	PCB Dipole	IPEX MHF4	2 dBi	-
Laird Connectivity	FlexPIFA	001-0022	PCB Dipole	IPEX MHF4	-	2 dBi
Mag.Layers	EDA-8709-2G4C1-B27-CY	0600-00057	Dipole	IPEX MHF4	2 dBi	-

Manufacturer	Model	Laird Connectivity Part Number	Type	Connector	Peak Gain	
					2400-2500 MHz	2400-2480 MHz
Laird Connectivity	mFlexPIFA	EFA2400A3S-10MH4L	PIFA	IPEX MHF4	-	2 dBI
Laird Connectivity	Laird Connectivity NFC	0600-00061	NFC	N/A	-	-
Laird Connectivity	BL653 PCB printed antenna	NA	Printed PCB	N/A	0 dBi	-

**Note:** The BL653 module internal BLE chipset IC pins are rated 2 kV (ESD HBM). ESD can find its way through the external JTAG connector (if used on the customer's design), if discharge is applied directly. Customer should ensure adequate protection against ESD on their end product design (using the BL653 module) to meet relevant ESD standard (for CE, this is EN301-489).

## 11.2 EU Declarations of Conformity

<b>Manufacturer</b>	Laird Connectivity
<b>Products</b>	453-00039, 453-00041
<b>Product Description</b>	Bluetooth v5.1 + 802.15.4 + NFC
<b>EU Directives</b>	2014/53/EU – Radio Equipment Directive (RED)

Reference standards used for presumption of conformity:

Article Number	Requirement	Reference standard(s)
3.1a	Low voltage equipment safety RF Exposure	EN 60950-1:2006 +A11:2009 +A1:2010 +A12:2011 +A2:2013
		EN 62311:2008
		EN 50385:2017
3.1b	Protection requirements – Electromagnetic compatibility	EN 301 489-1 v2.2.0 (2017-03) (Draft)
		EN 301 489-3 v2.1.1 (Draft)
		EN 301 489-17 v3.2.0 (2017-03) (Draft)
3.2	Means of the efficient use of the radio frequency spectrum (ERM)	EN 300 328 v2.1.1 (2016-11)      Wide-band transmission systems
		EN 300 330 v2.1.1 (2017-02)      Short Range Devices (SRD)

### Declaration:

We, Laird Connectivity, declare under our sole responsibility that the essential radio test suites have been carried out and that the above product to which this declaration relates is in conformity with all the applicable essential requirements of Article 3 of the EU Radio Equipment Directive 2014/53/EU, when used for its intended purpose.

The minimum distance between the user and/or any bystander and the radiating structure of the transmitter is 20 cm.

Place of Issue:	Laird Connectivity W66N220 Commerce Court, Cedarburg, WI 53012 USA tel: +1-262-375-4400      fax: +1-262-364-2649
Date of Issue:	
Name of Authorized Person:	
Signature of Authorized Person:	

## 12 ORDERING INFORMATION

Part Number	Product Description
453-00039R	BLE module (Nordic nRF52833) – Integrated antenna (Tape/Reel)
453-00041R	BLE module (Nordic nRF52833) – Trace pin (Tape/Reel)
453-00039C	BLE module (Nordic nRF52833) – Integrated antenna (Cut Tape)
453-00041C	BLE module (Nordic nRF52833) – Trace pin (Cut Tape)
453-00039-K1	Development Kit for Bluetooth +802.15.4 + NFC module – Integrated antenna
453-00041-K1	Development Kit for Bluetooth +802.15.4 + NFC module – Trace pin (External antenna)

## 13 BLUETOOTH SIG QUALIFICATION

### 13.1 Overview

The BL653 module is listed on the Bluetooth SIG website as a qualified End Product.

Design Name	Owner	Declaration ID	QD ID	Link to listing on the SIG website
BL653	Laird Connectivity	D049591	147394	<a href="https://launchstudio.bluetooth.com/ListingDetails/104900">https://launchstudio.bluetooth.com/ListingDetails/104900</a>

It is a mandatory requirement of the Bluetooth Special Interest Group (SIG) that every product implementing Bluetooth technology has a Declaration ID. Every Bluetooth design is required to go through the qualification process, even when referencing a Bluetooth Design that already has its own Declaration ID. The Qualification Process requires each company to register as a member of the Bluetooth SIG – [www.bluetooth.org](http://www.bluetooth.org)

The following link provides a link to the Bluetooth Registration page: <https://www.bluetooth.org/login/register/>

For each Bluetooth Design, it is necessary to purchase a Declaration ID. This can be done before starting the new qualification, either through invoicing or credit card payment. The fees for the Declaration ID will depend on your membership status, please refer to the following webpage:

<https://www.bluetooth.org/en-us/test-qualification/qualification-overview/fees>

For a detailed procedure of how to obtain a new Declaration ID for your design, please refer to the following SIG document:

[https://www.bluetooth.org/DocMan/handlers/DownloadDoc.ashx?doc\\_id=283698&vId=317486](https://www.bluetooth.org/DocMan/handlers/DownloadDoc.ashx?doc_id=283698&vId=317486)

### 13.2 Qualification Steps When Referencing a Laird Connectivity End Product Design

To start a listing, go to: [https://www.bluetooth.org/tpg/QLI\\_SDoc.cfm](https://www.bluetooth.org/tpg/QLI_SDoc.cfm)

In step 1, select the option, **Reference a Qualified Design** and enter D049591 in the End Product table entry. You can then select your pre-paid Declaration ID from the drop-down menu or go to the Purchase Declaration ID page, (please note that unless the Declaration ID is pre-paid or purchased with a credit card, it will not be possible to proceed until the SIG invoice is paid.

Once all the relevant sections of step 1 are finished, complete steps 2, 3, and 4 as described in the help document. Your new Design will be listed on the SIG website and you can print your Certificate and Declaration of Conformity.

For further information, please refer to the following training material:

<https://www.bluetooth.org/en-us/test-qualification/qualification-overview/listing-process-updates>

**Note:** If using the BL653 with Laird Connectivity Firmware and *smartBASIC* script, you can skip “Controller Subsystem”, “Host Subsystem”, and “Profile Subsystem”.

## 13.3 Qualification Steps When Deviating from a Laird Connectivity End Product Design

If you wish to deviate from the standard End Product design listed under D0xxxxx, the qualification process follows the Traditional Project route, creating a new design. When creating a new design, it is necessary to complete the full qualification listing process and also maintain a compliance folder for the new design.

The BL653 design under D049591 incorporates the following components:

Listing reference	Design Name	Core Spec Version
<b>D043345</b>	S140 Link Layer v7.0.1	5.1
<b>D043346</b>	S140 Host Layer v7.0.1	5.1

In the future, Nordic may list updated versions of these components and it is possible to use them in your new design. Please check with Nordic to make sure these software components are compatible with the nRF52833 hardware.

If your design is based on un-modified BL653 hardware it is possible use the following process;

1. Reference the existing RF-PHY test report from the BL653 listing.
2. Combine the relevant Nordic Link Layer (LL) – check QDID with Nordic.
3. Combine in a Host Component (covering L2CAP, GAP, ATT, GATT, SM) - check QDID with Nordic.
4. Test any standard SIG profiles that are supported in the design (customs profiles are exempt).

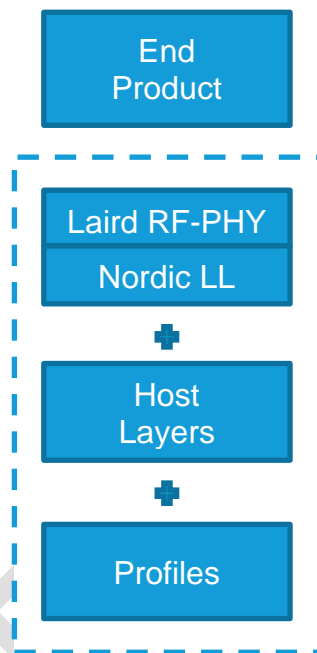

**Figure 23: Scope of the qualification for an End Product Design**

The first step is to generate a project on the TPG (Test Plan Generator) system. This determines which test cases apply to demonstrate compliance with the Bluetooth Test Specifications. If you are combining pre-tested and qualified components in your design and they are within their three-year listing period, you are not required to re-test those layers covered by these components.

If the design incorporates any standard SIG LE profiles (such as Heart Rate Profile), it is necessary to test these profiles using PTS or other tools where permitted; the results are added to the compliance folder.

You are required to upload your test declaration and test reports (where applicable) and then complete the final listing steps on the SIG website. Remember to purchase your Declaration ID before you start the qualification process, as it's impossible to complete the listing without it.

## 14 ADDITIONAL ASSISTANCE

Please contact your local sales representative or our support team for further assistance:

Laird Connectivity

Support Centre: <https://www.lairdconnect.com/resources/support>

Email: [wireless.support@lairdconnectivity.com](mailto:wireless.support@lairdconnectivity.com)

Phone: Americas: +1-800-492-2320

Europe: +44-1628-858-940

Hong Kong: +852 2923 0610

Web: <https://www.lairdconnect.com/products>

---

**Note:** Information contained in this document is subject to change.

---

© Copyright 2020 Laird Connectivity. All Rights Reserved. Patent pending. Any information furnished by Laird and its agents is believed to be accurate and reliable. All specifications are subject to change without notice. Responsibility for the use and application of Laird materials or products rests with the end user since Laird and its agents cannot be aware of all potential uses. Laird makes no warranties as to non-infringement nor as to the fitness, merchantability, or sustainability of any Laird materials or products for any specific or general uses. Laird Connectivity or any of its affiliates or agents shall not be liable for incidental or consequential damages of any kind. All Laird products are sold pursuant to the Laird Terms and Conditions of Sale in effect from time to time, a copy of which will be furnished upon request. Nothing herein provides a license under any Laird or any third-party intellectual property right.

## X-ON Electronics

Largest Supplier of Electrical and Electronic Components

*Click to view similar products for [Bluetooth Modules - 802.15.1 category](#):*

*Click to view products by [Laird Connectivity manufacturer](#):*

Other Similar products are found below :

[A2541R24A10GM](#) [CYBLE-212023-10](#) [BM78SPP05MC2-0002AA](#) [CYW20732S](#) [968EMB0019](#) [E73-2G4M08S1CX](#) [TB-03F](#) [TB-03F-AT\\_Mesh](#) [TB-04](#) [TB-04--AT\\_Mesh](#) [BT3L\(jibu\)](#) [BT5S\(xoft\)](#) [BT5S\(4k43\)](#) [BT5S\(jcyv\)](#) [ENW89857A1KF](#) [ENW49D01A1KF](#) [SPB228-D-188980124](#) [DG100 IOT EDGE GATEWAY](#) [1327](#) [RN42HID-I/RM](#) [ENW-89829C3KF](#) [BLE113-A-V1](#) [BM70BLE01FC2-0B03AA](#) [ACN52832](#) [A2541E24A10GM](#) [RN42-I/RM630](#) [450-0168R](#) [MOTG-BLUETOOTH](#) [ABBTM-2.4GHz-52-T](#) [ABBTM-2.4GHz-T](#) [ABBTM-2.4GHz-T2](#) [ACN52840](#) [4076](#) [4077](#) [AFERO-BL24-01](#) [BLED112](#) [BM62SPKS1MC2-0001AA](#) [BM78SPPS5MC2-0002AA](#) [PX0880/1](#) [DAT12](#) [BT680F](#) [PBA31309V1.00 S LK64](#) [ATSAMB11-MR510CA](#) [BM20SPKA1NBC-0001AA](#) [BM20SPKS1NBC-0001AA](#) [BM23SPKS1NB9-0B02AA](#) [BM70BLE01FC2-0B04AA](#) [BM77SPP03MC2-0007AA](#) [BM77SPP03MC2-0008AA](#)