



Smart Technology. Delivered.

EMI FILTERING & RF INDUCTORS



About Laird

Laird is a global technology business focused on enabling wireless communication and smart systems, and providing components and systems that protect electronics. Laird operates through two divisions, Wireless Systems and Performance Materials. Wireless Systems solutions include antenna systems, embedded wireless modules, telematics products and wireless automation and control solutions. Performance Materials solutions include electromagnetic interference shielding, thermal management and signal integrity products. As a leader in the design, supply and support of innovative technology, our products allow people, organisations, machines and applications to connect effectively, helping to build a world where smart technology transforms the way of life. Custom products are supplied to major sectors of the electronics industry including the handset, telecommunications, IT, automotive, public safety, consumer, medical, rail, mining and industrial markets. Providing value and differentiation to our customers through innovation, reliable fulfilment and speed, Laird PLC is listed and headquartered in London, and employs over 9,000 people in more than 58 facilities located in 18 countries.



Smart Technology. Delivered.

Table of Contents

Part Number Nomenclature Explanation	2
Ferrite EMI Chip Beads	3
Ferrite EMI SMT Bead Assemblies	26
Common Mode And Differential Mode Explanation	29
Common Mode Choke Family	30
Common Mode Chokes	31
Low Frequency Common Mode Chokes	37
Common Mode Arrays	38
CAN-BUS Common Mode Choke Series	43
Passes and Turns	45
Wire-Wound SMT Power Common Mode Chokes	46
Wire-Wound DIP Power Common Mode Chokes	48
Common Mode Choke Series	51
Differential Mode EMI Filters	53
EMI Filter Arrays	56
Differential Mode Filter Equivalent Circuits	59
Ferrite Chip Inductors	60
Multilayer Power Chip Inductors	64



All parts listed in this catalog are lead free and RoHS compliant.

NOTICE

Laird products or subcomponents are not specifically designed or tested by Laird for use in any medical application, medical device manufacturing, or any similar procedure or process requiring approval, testing, or certification and drug administration or other similar Governmental entity. Applications with unusual environmental medical, life-support or Life-sustaining equipment are specifically not recommended without additional

PART NUMBER

Nomenclature Explanation

PART NUMBERING SYSTEM

HZ PRODUCT SERIES CODE	0402 EIA SIZE CODE	A RATED CURRENT CODE	601 IMPEDANCE (Z) OR INDUCTANCE (L)	R PACKING CODE	-10 ADDITIONAL DESCRIPTION
HI = High Current Chip Beads (≥3,000 mA)	0402 2545 0504 2722	A < 100 mA B = 200 mA C = 300 mA D = 400 mA E = 500 mA F = 600 mA G = 700 mA H = 800 mA I = 900 mA J = 1,000 mA K = 1,500 mA L = 2,000 mA M = 2,500 mA N = 3,000 mA O = 3,500 mA P = 4,000 mA Q = 4,500 mA R = 5,000 mA S = 5,500 mA T = 6,000 mA U = 7,000 mA V = 8,000 mA W = 9,000 mA X = 10,000 mA Y = 15,000 mA Z ≥ 20,000 mA	First two numbers are Significant Digits The last number indicates how many zeros are added to the significant digits. Impedance Examples: 100 = 10 OHMS 101 = 100 OHMS 102 = 1,000 OHMS 202 = 2,000 OHMS 060 = 6 OHMS Examples: (For IC Series) 470 = 47 nH 471 = 470 nH 472 = 4,700 nH 473 = 47,000 nH Examples: (For CCI series) 0N3 = 0.3 nH 1N2 = 1.2 nH 12N = 12 nH R12 = 120 nH R22 = 220 nH Examples: (For CPI series) R47 = 0.47 uH 1R0 = 1.0 uH 4R7 = 4.7 uH Examples: (For CMX series) 680 = 68 uH 181 = 180 uH 132 = 1300 uH	B: Bulk Standard Thru- Hole Packaging R: Tape&Reel Standard SMT Package	-10 = Lead Free Standard Catalog Part -11 to -99 = Non-Standard or Custom Part -1□ = Tolerance Code
MI = Mid Current Chip Beads (≥1,000 mA to <3,000 mA)	0603 3032 0805 3312 0806 3322				
LI = Low Current Chip Beads (<1,000 mA, <400 Ω Z)	1008 3421 1206 3822				
HZ = High Impedance Chip Beads (<1,000 mA, >400 Ω Z)	1210 4440 1211 4545 1616 4732				
HF = High Frequency Chip Beads	1612 5022				
LF = Low Frequency Chip Beads	1806 5441				
HR = High Bias Retention Chip Beads (>3,000 mA)	1812 6032 1922 2021				
CC = CAN-Bus Common Mode Chokes	2220 2520				
CM = Common Mode Chokes					
CMX = Wire-Wound Power Common Mode Chokes					
CF = Small Size (0805, 0504) Monolithic Common Mode Chokes					
DA = Multilines Array Chip Arrays					
IC = Ferrite Chip Inductors					
CCI = Ceramic Chip Inductors					
CPI = Multilayer Power Chip Inductors					

PART NUMBERING SYSTEM

29 MATERIAL TYPE	F PRODUCT TYPE CODE	0818 PART SIZE CODE	-1 MINOR DIMENSION CODE	S BOARD MOUNTING STYLE	R PACKAGING CODE	-10 ADDITIONAL DESCRIPTION
28 & 29 = Broad Band Material 35 = Low Freq. Material	C = Choke L = Axial Leaded Bead F = Assembled Part	Unique Part Identifier or Significant Dimension	Height or Length Variation	S = Surface Mount T = Thru-Hole	O = Bulk Standard R = Tape & Reel Standard SMT Package	-10 = Lead Free Standard Catalog Part -11 to -99 = Non Standard or Custom Part

TEST CONDITIONS

Operation temperature: -40°C ~ +125°C (If no parts are specifically defined)

Visit www.lairdtech.com for additional and the most up-to-date information and for other board level part families not included in this catalog. All data charts are available by contacting your local Laird office.

A revolutionary new SPICE model for EMI ferrite chip beads is now available from Laird. This new design aid includes the de-rating effects of DC bias currents providing much greater accuracy for better designs the first time. This chip bead SPICE model is available by contacting your local Laird office.

Note: Most current ratings (I MAX) are based upon a 40°C temperature rise during continuous operation. Parts have no polarity.

FERRITE EMI
CHIP BEADS



FEATURES



- Up to 10 Amps (I MAX) continuous operating capability
- Monolithic construction with small footprint and high reliability
- Excellent retention under bias
- Economical
- Broad range of sizes (from EIA 0201 up to 3312)
- For power line, low frequency and high frequency signal lines

PART NUMBERING SYSTEM

HZ	0402	A	601	R	-10
Product Series Code	EIA Size Code	Rated Current Code	Impedance Value Code	Packing Code	Additional Description

FOR SIGNAL LINE

EIA Pkg. Size	Metric Pkg. Size	Part Number	Typical Impedance (Ω)				Typical Peak Impedance (Ω)	Peak Impedance Frequency (MHz)	DCR MAX (Ω)	RATED I MAX (continuous) mA
			Z 25 MHz	Z @ 100 MHz	Z @ 500 MHz	Z @ 1 GHz				
0402	1005	LI0402E190R-10	6	19	43	56	59	1,519	0.10	500
0402	1005	LI0402C220R-10	9	22	30	31	31	830	0.20	300
0402	1005	LI0402E300R-10	9	30	50	57	58	1,195	0.30	500
0402	1005	LI0402C470R-10	15	47	76	90	92	1,402	0.15	300
0402	1005	LI0402E600R-10	29	60	90	57	97	801	0.30	500
0402	1005	LI0402B800R-10	32	80	220	224	243	769	0.80	200
0402	1005	LI0402E800R-10	34	80	126	132	132	867	0.17	500
0402	1005	LI0402D121R-10	40	120	205	195	213	682	0.40	400
0402	1005	LI0402C221R-10	72	220	443	243	453	440	0.35	300
0402	1005	LI0402B301R-10	96	300	454	351	549	374	0.80	200
0402	1005	HZ0402A601R-10	182	600	600	300	965	241	1.00	100
0402	1005	HZ0402B102R-10	225	1,000	489	222	1,116	182	1.00	200
0402	1005	HZ0402A152R-10	400	1,500	441	200	1,500	143	2.00	50
0402	1005	HZ0402A182R-10	251	1,800	520	265	2,702	143	1.40	100
0603	1608	LI0603E470R-10	17	47	83	91	91	1,000	0.10	500
0603	1608	LI0603G800R-10	32	80	100	91	100	500	0.20	700
0603	1608	LI0603G121R-10	52	120	156	113	177	389	0.20	700
0603	1608	LI0603E151R-10	61	150	197	131	209	331	0.25	500
0603	1608	LI0603B201R-10	70	200	340	210	362	420	0.40	200
0603	1608	LI0603G221R-10	98	220	279	168	283	251	0.30	700
0603	1608	LI0603D301R-10	144	300	286	165	389	261	0.35	400
0603	1608	HZ0603B471R-10	94	470	560	253	1,060	240	0.85	200
0603	1608	HZ0603C601R-10	232	600	360	171	775	168	0.45	300
0603	1608	HZ0603C651R-10	296	650	954	652	960	400	0.60	300
0603	1608	HZ0603B751R-10	302	750	437	198	863	137	0.60	200

FERRITE EMI
CHIP BEADS

FOR SIGNAL LINE

EIA PKG. SIZE	METRIC PKG. SIZE	PART NUMBER	TYPICAL IMPEDANCE (Ω)				TYPICAL PEAK IMPEDANCE (Ω)	PEAK IMPEDANCE FREQUENCY (MHz)	DCR MAX (Ω)	RATED I MAX (CONTINUOUS) mA
			Z @ 25 MHz	Z @ 100 MHz	Z @ 500 MHz	Z @ 1 GHz				
0603	1608	HZ0603A102R-10	288	1,000	1975	1,450	2,000	480	1.00	100
0603	1608	HZ0603B102R-10	453	1,000	380	200	1,000	100	0.60	200
0603	1608	HZ0603D102R-10	453	1,000	380	193	970	140	0.35	400
0603	1608	HZ0603B112R-10	515	1,100	1,300	850	1,539	288	0.80	200
0603	1608	HZ0603A152R-10	552	1,500	1,062	503	2,306	190	0.90	100
0603	1608	HZ0603C152R-10	319	1,500	462	190	1,493	135	0.60	300
0603	1608	HZ0603A182R-10	610	1,800	1,070	500	2,420	180	1.50	50
0603	1608	HZ0603A222R-10	195	2,200	375	175	3,051	122	1.50	100
0603	1608	HZ0603A252R-10	791	2,500	1,014	501	3,065	149	1.50	50
0805	2012	LI0805G201R-10	100	200	221	128	272	250	0.30	700
0805	2012	LI0805G301R-10	124	300	248	146	350	205	0.20	700
0805	2012	HZ0805G471R-10	221	470	286	150	572	149	0.20	700
0805	2012	HZ0805E601R-10	277	600	304	151	696	155	0.30	500
0805	2012	HZ0805D102R-10	280	1,000	328	168	1,268	113	0.30	400
0805	2012	MI0805J102R-10	195	1,000	226	108	1,112	120	0.15	1,000
0805	2012	HZ0805D152R-10	289	1,500	333	166	1,525	110	0.40	400
0805	2012	HZ0805C202R-10	350	2,000	300	150	2,000	100	0.50	300
0805	2012	HZ0805B222R-10	648	2,200	419	213	2,200	100	0.80	200
0805	2012	HZ0805B252R-10	400	2,500	400	180	2,900	90	0.75	200
0805	2012	HZ0805B272R-10	400	2,700	400	150	2,900	88	0.80	200
1206	3216	HZ1206E601R-10	296	600	202	103	674	75	0.30	500
1206	3216	HZ1206C202R-10	1,673	915	180	100	2,505	41	0.50	300
1206	3216	HZ1206E152R-10	823	950	188	57	1,564	57	0.30	500
1206	3216	HZ1206D102R-10	201	1,250	250	100	1,000	100	0.40	400

FOR POWER LINE

EIA PKG. SIZE	METRIC PKG. SIZE	PART NUMBER	TYPICAL IMPEDANCE (Ω)				TYPICAL PEAK IMPEDANCE (Ω)	PEAK IMPEDANCE FREQUENCY (MHz)	DCR MAX (Ω)	RATED I MAX (CONTINUOUS) mA
			Z @ 25 MHz	Z @ 100 MHz	Z @ 500 MHz	Z @ 1 GHz				
0402	1005	MI0402L100R-10	3.6	10	14	13.2	15	510	0.10	2,000
0402	1005	LI0402E190R-10	6	19	43	56	59	1,519	0.10	500
0402	1005	LI0402C220R-10	9	22	30	31	31	830	0.20	300
0402	1005	LI0402E300R-10	9	30	50	57	58	1,195	0.30	500
0402	1005	LI0402C470R-10	15	47	76	90	92	1,402	0.15	300
0402	1005	LI0402E600R-10	29	60	90	57	97	801	0.30	500
0402	1005	LI0402E750R-10	30	75	92	92	93	710	0.10	500
0402	1005	LI0402B800R-10	32	80	220	224	243	769	0.80	200
0402	1005	LI0402E800R-10	34	80	126	132	243	867	0.17	500
0402	1005	LI0402D121R-10	40	120	205	195	213	682	0.40	400
0402	1005	MI0402K121R-10	52	120	160	132	160	500	0.13	1,500
0402	1005	LI0402C221R-10	72	220	443	243	453	440	0.35	300
0402	1005	LI0402B301R-10	96	300	454	351	549	374	0.80	200
0402	1005	HZ0402B102R-10	225	1,000	489	222	1,116	182	1.00	200
0603	1608	MI0603K300R-10	12	30	43	45	45	1,000	0.09	1,500
0603	1608	HI0603N300R-10	13	30	44	48	54	1,000	0.04	3,000
0603	1608	HI0603R300R-10	13	30	44	45	47	950	0.01	5,000
0603	1608	HI0603N330R-10	13	33	44	54	54	1,000	0.025	3,000
0603	1608	LI0603E470R-10	17	47	83	91	91	1,000	0.10	500
0603	1608	MI0603J600R-10	25	60	91	92	95	700	0.10	1,000
0603	1608	HI0603P600R-10	25	60	85	83	95	738	0.03	4,000
0603	1608	MI0603J680R-10	35	68	106	99	110	650	0.10	1,000
0603	1608	HI0603O700R-10	32	70	91	94	98	600	0.02	3,500
0603	1608	LI0603G800R-10	32	80	100	91	100	500	0.20	700

FERRITE EMI
CHIP BEADS

FOR POWER LINE

EIA PKG. SIZE	METRIC PKG. SIZE	PART NUMBER	TYPICAL IMPEDANCE (Ω)				TYPICAL PEAK IMPEDANCE (Ω)	PEAK IMPEDANCE FREQUENCY (MHZ)	DCR MAX (Ω)	RATED I MAX (CONTINUOUS) MA
			Z @ 25 MHZ	Z @ 100 MHZ	Z @ 500 MHZ	Z @ 1 GHZ				
0603	1608	LI0603G121R-10	52	120	156	113	177	389	0.20	700
0603	1608	MI0603M121R-10	55	120	169	138	170	420	0.05	2,500
0603	1608	LI0603E151R-10	61	150	197	131	209	331	0.25	500
0603	1608	MI0603K181R-10	95	180	238	190	245	380	0.09	1,500
0603	1608	LI0603B201R-10	70	200	340	210	362	420	0.40	200
0603	1608	LI0603G221R-10	98	220	279	168	283	251	0.30	700
0603	1608	MI0603L221R-10	107	220	219	121	240	280	0.05	2,000
0603	1608	LI0603D301R-10	144	300	286	165	389	261	0.35	400
0603	1608	MI0603L301R-10	50	300	225	120	410	200	0.10	2,000
0603	1608	HZ0603B471R-10	94	470	560	253	1,060	240	0.85	200
0603	1608	MI0603J471R-10	203	470	398	181	580	210	0.20	1,000
0603	1608	MI0603K471R-10	237	470	350	193	562	197	0.15	1,500
0603	1608	HZ0603C601R-10	232	600	360	171	775	168	0.45	300
0603	1608	MI0603J601R-10	225	600	400	200	620	150	0.20	1,000
0603	1608	HZ0603C651R-10	296	650	954	652	960	400	0.60	300
0603	1608	HZ0603B751R-10	302	750	437	198	863	137	0.60	200
0603	1608	HZ0603B102R-10	453	1,000	380	200	1,000	100	0.60	200
0603	1608	MI0603J102R-10	432	1,000	400	196	1,000	120	0.20	1,000
0603	1608	HZ0603B112R-10	515	1,100	1,300	850	1,539	288	0.80	200
0603	1608	HZ0603C152R-10	319	1,500	462	190	1,590	135	0.60	300
0805	2012	MI0805K110R-10	5	11	18	19	20	1,000	0.06	1,500
0805	2012	HI0805Q310R-10	12	31	42	44	45	800	0.025	4,500
0805	2012	HI0805N310R-10	17	31	41	39	42	510	0.03	3,000
0805	2012	HI0805P390R-10	17	39	59	65	65	1,050	0.008	4,000
0805	2012	LI0805H400R-10	18	40	70	76	76	1,000	0.15	800
0805	2012	MI0805K400R-10	19	40	60	63	69	903	0.05	1,500
0805	2012	HI0805T500R-10	25	50	64	59	65	490	0.01	6,000
0805	2012	HI0805N600R-10	34	60	80	75	81	500	0.04	3,000
0805	2012	LI0805H750R-10	31	75	128	130	132	769	0.15	800
0805	2012	HI0805R800R-10	38	80	70	38	100	200	0.01	5,000
0805	2012	LI0805H121R-10	53	120	170	114	170	340	0.15	800
0805	2012	HI0805O121R-10	61	120	140	80	167	270	0.02	3,500
0805	2012	HI0805R121R-10	47	120	98	58	149	205	0.03	5,000
0805	2012	HI0805P121R-10	45	120	102	64	125	240	0.02	4,000
0805	2012	LI0805H151R-10	73	150	207	150	210	400	0.15	800
0805	2012	LI0805G201R-10	100	200	221	128	272	250	0.30	700
0805	2012	MI0805M221R-10	100	220	274	115	287	260	0.05	2,500
0805	2012	HI0805N221R-10	81	220	113	115	283	220	0.04	3,000
0805	2012	LI0805G301R-10	124	300	248	146	350	205	0.20	700
0805	2012	MI0805L301R-10	135	300	271	147	350	200	0.06	2,000
0805	2012	MI0805L331R-10	148	330	264	143	197	393	0.06	2,000
0805	2012	HZ0805G471R-10	221	470	286	150	572	149	0.20	700
0805	2012	HZ0805E601R-10	277	600	304	151	696	155	0.30	500
0805	2012	MI0805K601R-10	280	600	240	120	723	130	0.10	1,500
0805	2012	MI0805L601R-10	264	600	316	172	663	155	0.10	2,000
0805	2012	HZ0805D102R-10	280	1,000	328	168	1,268	113	0.30	400
0805	2012	MI0805J102R-10	195	1,000	226	108	1,112	120	0.15	1,000
0805	2012	HZ0805D152R-10	289	1,500	333	166	1,525	110	0.40	400
0805	2012	HZ0805C202R-10	350	2,000	300	150	2,000	100	0.50	300
1206	3216	MI1206K260R-10	12	26	44	46	46	1,000	0.06	1,500
1206	3216	MI1206K310R-10	12	31	37	41	41	1,000	0.045	1,500
1206	3216	HI1206T500R-10	19	50	66	70	70	1,000	0.01	6,000
1206	3216	HI1206N680R-10	29	68	93	102	102	1,000	0.012	3,000
1206	3216	HI1206N800R-10	38	80	120	129	130	800	0.035	3,000
1206	3216	MI1206K900R-10	44	90	142	150	154	867	0.08	1,500
1206	3216	HI1206N101R-10	41	100	144	145	150	600	0.035	3,000
1206	3216	LI1206H121R-10	53	120	144	135	145	422	0.15	800
1206	3216	HI1206P121R-10	56	120	130	105	142	300	0.03	4,000
1206	3216	LI1206H151R-10	73	150	173	123	182	241	0.15	800
1206	3216	HI1206T161R-10	71	160	220	127	229	251	0.018	6,000
1206	3216	MI1206L391R-10	100	390	160	90	460	130	0.05	2,000

FERRITE EMI CHIP BEADS

FOR POWER LINE

EIA PKG. SIZE	METRIC PKG. SIZE	PART NUMBER	TYPICAL IMPEDANCE (Ω)				TYPICAL PEAK IMPEDANCE (Ω)	PEAK IMPEDANCE FREQUENCY (MHZ)	DCR MAX (Ω)	RATED I MAX (CONTINUOUS) MA
			Z @ 25 MHz	Z @ 100 MHz	Z @ 500 MHz	Z @ 1 GHz				
1206	3216	MI1206L501R-10	210	500	150	82	500	100	0.06	2,000
1206	3216	HZ1206E601R-10	296	600	202	103	674	75	0.30	500
1206	3216	MI1206K601R-10	300	600	250	130	650	80	0.08	1,500
1206	3216	MI1206L601R-10	296	600	116	59	660	79	0.08	2,000
1206	3216	HZ1206E152R-10	823	950	188	57	1,564	57	0.30	500
1206	3216	HZ1206C202R-10	1,673	915	180	100	2,505	41	0.50	300
1206	3216	HZ1206D102R-10	201	1,000	185	100	1,000	100	0.40	400
1210	3225	MI1210K600R-10	30	60	90	95	105	900	0.035	1,500
1612	4131	HI1612X560R-10	23	56	75	79	79	1,000	0.004	10,000
1806	4516	HI1806T600R-10	28	60	87	92	92	1,000	0.01	6,000
1806	4516	LI1806E800R-10	28	80	117	117	117	1,000	0.30	500
1806	4516	MI1806J800R-10	34	78	114	118	119	903	0.03	1,000
1806	4516	HI1806N910R-10	42	91	140	150	150	1,000	0.03	3,000
1806	4516	LI1806E101R-10	45	100	157	164	166	966	0.30	500
1806	4516	LI1806C151R-10	60	150	219	222	223	871	0.50	300
1806	4516	HZ1806K102R-10	60	1,000	160	80	1,390	135	0.15	1,500
1812	4532	HI1812T800R-10	30	80	97	107	107	1,000	0.01	6,000
1812	4532	HI1812V101R-10	45	100	136	134	139	800	0.01	8,000
1812	4532	LI1812D121R-10	55	120	182	184	186	738	0.40	400
1812	4532	MI1812K121R-10	45	120	162	170	175	900	0.055	1,500
2220	5620	HI2220T101R-10	50	100	148	152	160	600	0.006	6,000
2220	5620	HI2220R151R-10	60	150	230	196	230	500	0.015	5,000
2220	5620	HI2220P171R-10	78	170	256	237	256	500	0.03	4,000
2220	5620	HI2220R181R-10	80	180	263	234	270	400	0.02	5,000
2220	5620	HI2220P251R-10	100	250	172	91	390	200	0.015	4,000
2220	5620	HI2220P271R-10	110	270	360	250	390	300	0.035	4,000
2220	5620	HI2220R301R-10	100	300	190	100	380	200	0.02	5,000
2220	5620	HI2220Q401R-10	100	400	159	99	450	150	0.03	4,500
2220	5620	HI2220P51R-10	180	550	670	343	850	300	0.035	4,000
2220	5620	HI2220P601R-10	220	600	184	106	600	100	0.025	4,000
2220	5620	HR2220P601R-10	200	600	150	75	600	100	0.025	4,000
2220	5620	HI2220P701R-10	200	700	140	90	700	100	0.025	4,000
2220	5620	HR2220V701R-10	198	700	120	62	760	91	0.01	8,000
2220	5620	HR2220V801R-10	150	800	125	75	910	90	0.01	8,000
3312	8531	HI3312X101R-10	39	100	160	172	172	1,000	0.004	10,000

4 LINES CHIP BEAD ARRAY

EIA PKG. SIZE	METRIC PKG. SIZE	PART NUMBER	TYPICAL IMPEDANCE (Ω)				TYPICAL PEAK IMPEDANCE (Ω)	PEAK IMPEDANCE FREQUENCY (MHZ)	DCR MAX (Ω)	RATED I MAX (CONTINUOUS) MA
			Z @ 25 MHz	Z @ 100 MHz	Z @ 500 MHz	Z @ 1 GHz				
1206	3216	DA1206E300R-10	10	30	55	56	56	1,000	0.30	500
1206	3216	DA1206D600R-10	15	60	115	132	133	1,103	0.20	400
1206	3216	DA1206C121R-10	39	120	181	151	211	559	0.20	300
1206	3216	DA1206D301R-10	94	300	437	245	437	500	0.40	400
1206	3216	DA1206B601R-10	180	600	475	230	761	214	0.35	200
1206	3216	DA1206B102R-10	275	1,000	520	240	1,129	175	0.80	200

LOW FREQUENCY EMI CHIP BEADS

EIA PKG. SIZE	METRIC PKG. SIZE	PART NUMBER	TYPICAL IMPEDANCE (Ω)			TYPICAL PEAK IMPEDANCE (Ω)	PEAK IMPEDANCE FREQUENCY (MHZ)	DCR MAX (Ω)	RATED I MAX (CONTINUOUS) mA
			Z	Z @ 100 MHz	Z @ 500 MHz				
1206	3216	LF1206A302R-10	3,000 @ 10 MHz	760	166	5,650	19	1.05	100
1206	3216	LF1206C202R-10	2,000 @ 30 MHz	915	180	2,505	41	0.50	300
1206	3216	LF1206E152R-10	1,500 @ 50 MHz	946	169	1,564	57	0.30	500
0805	2012	LF0805A252R-10	2,500 @ 10 MHz	1,248	306	5,138	25	1.25	100

0402 Chip Bead Impedance Under DC Bias

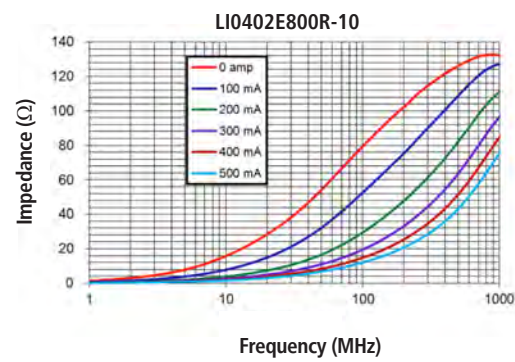
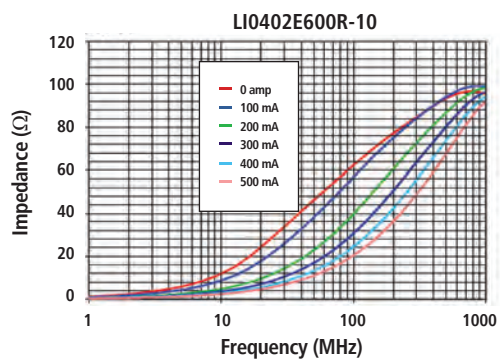
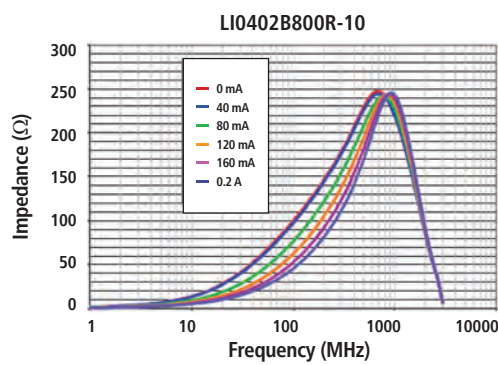
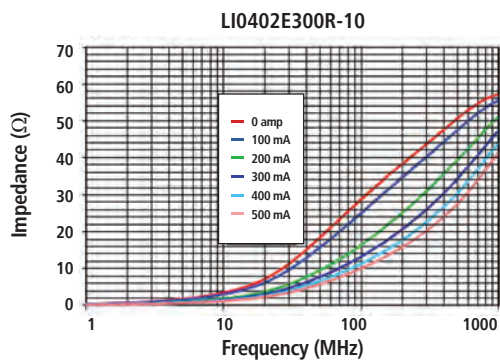
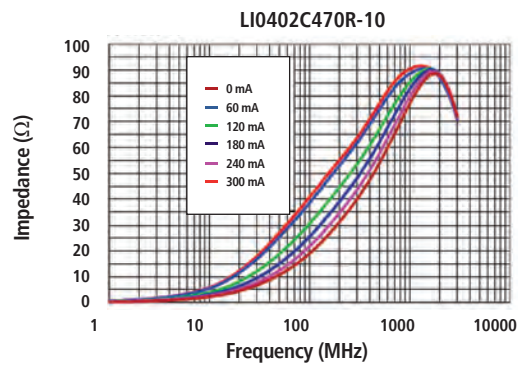
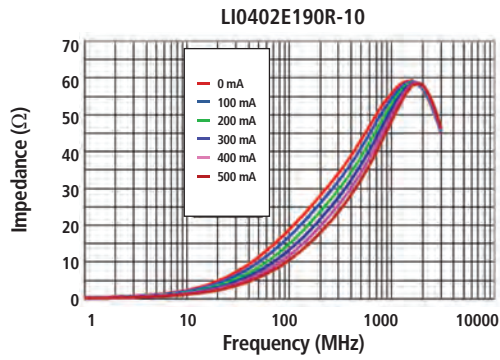
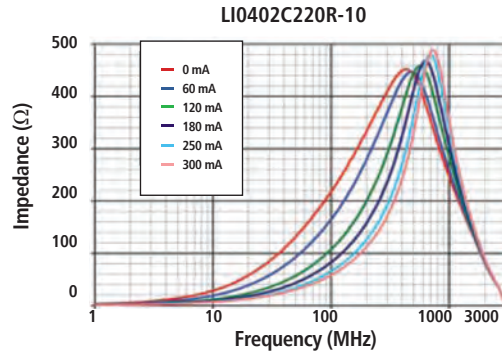
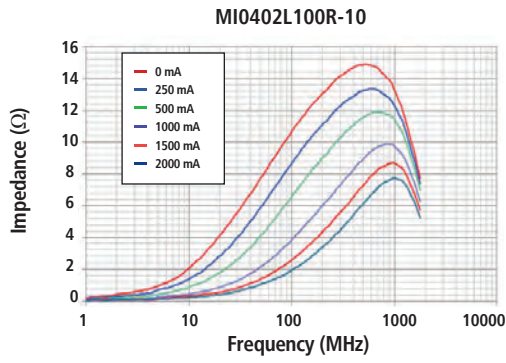

0402 Chip Bead Impedance Under DC Bias

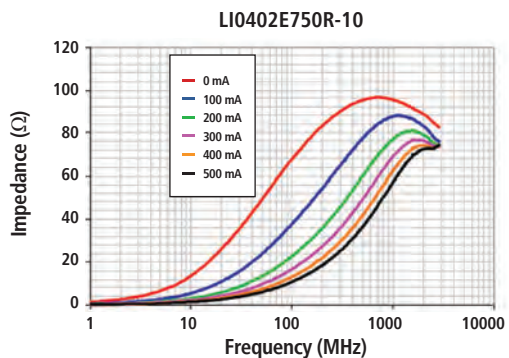
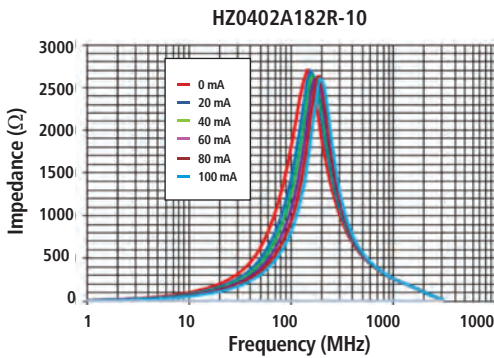
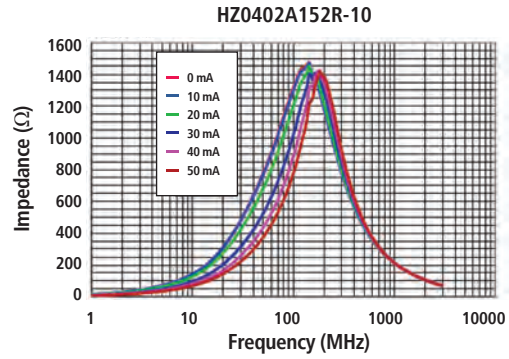
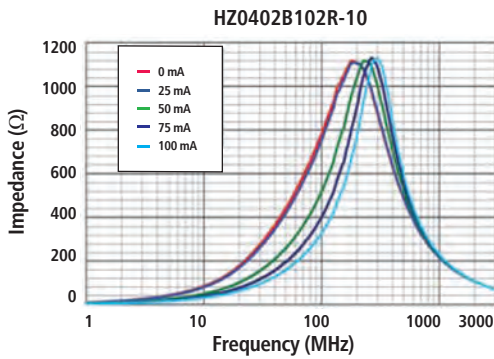
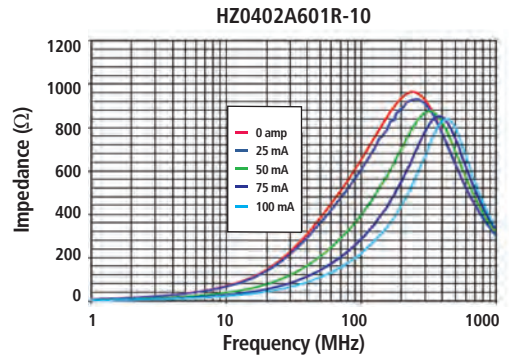
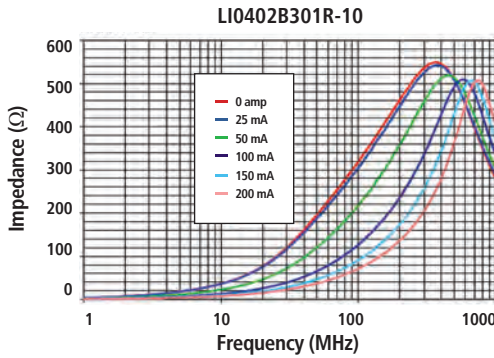
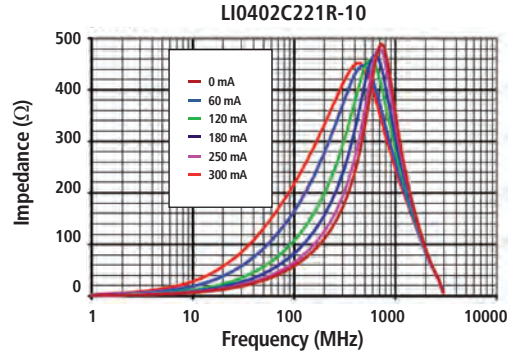
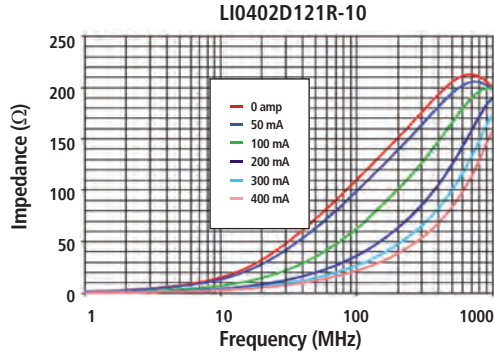

0402/0603 Chip Bead Impedance Under DC Bias

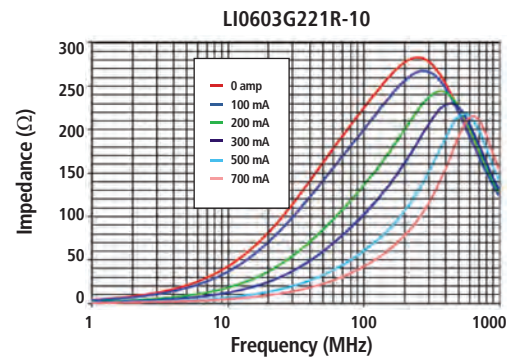
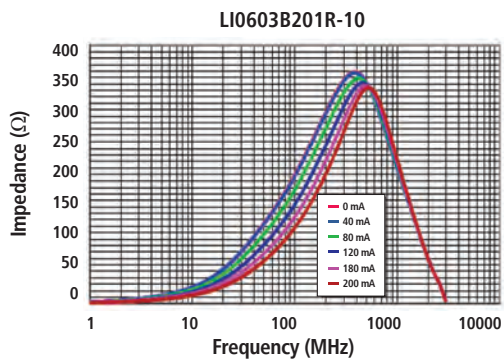
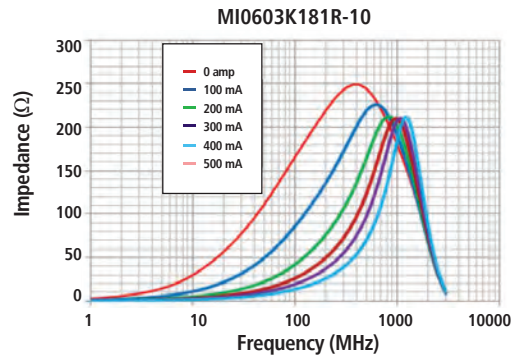
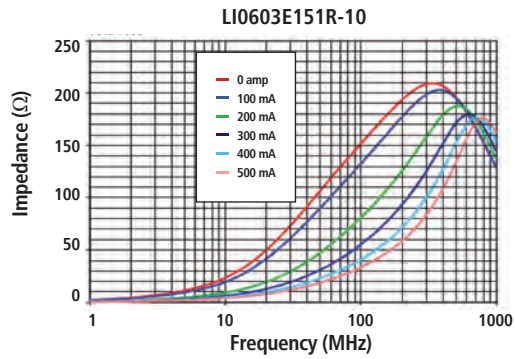
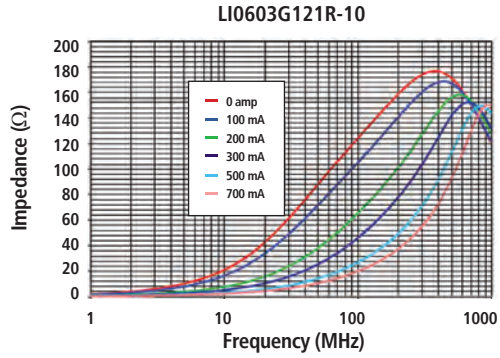
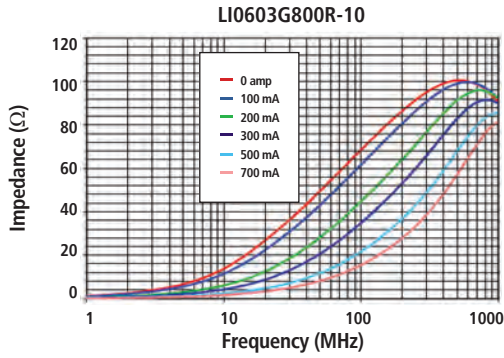
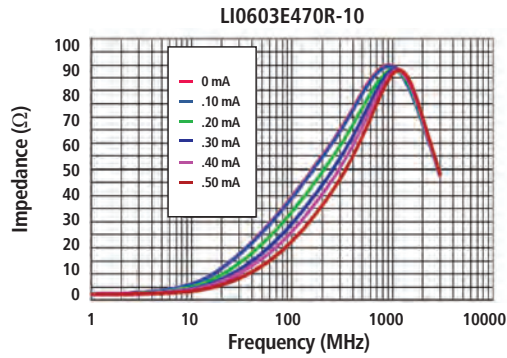
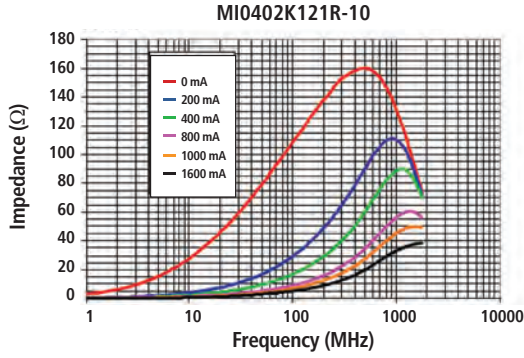

0603 Chip Bead Impedance Under DC Bias

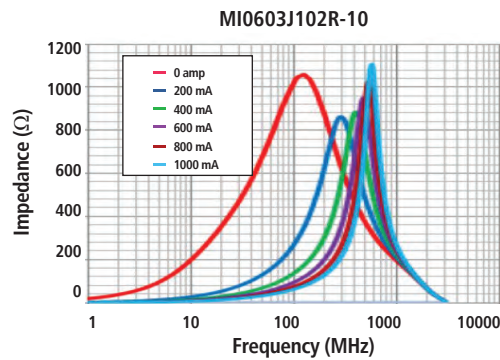
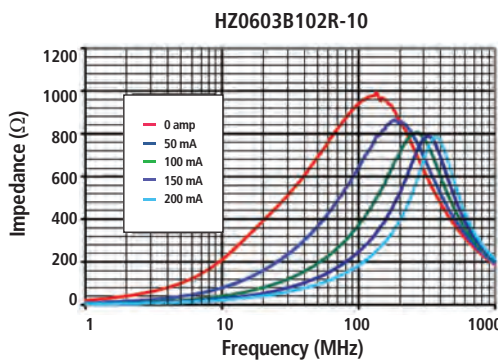
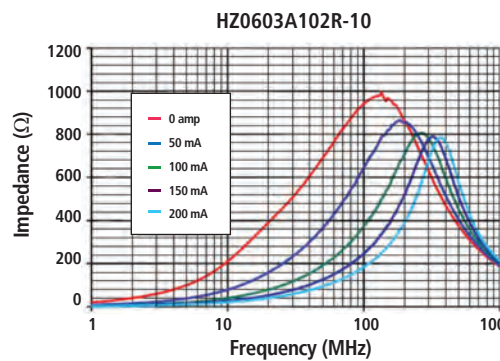
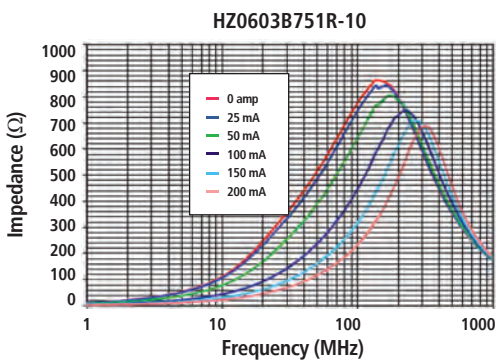
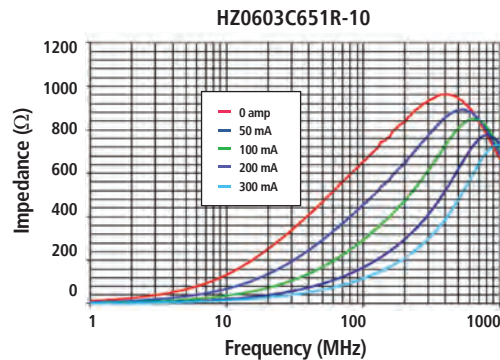
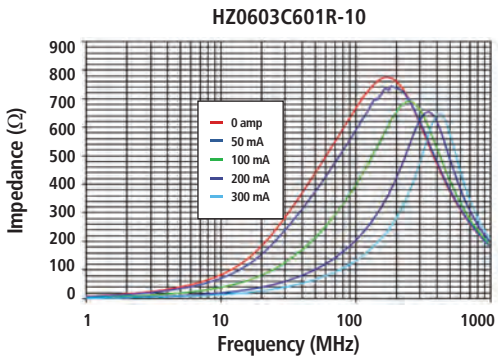
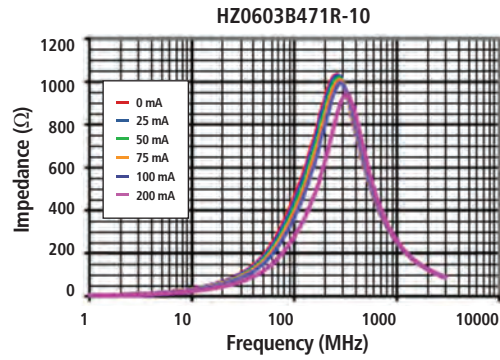
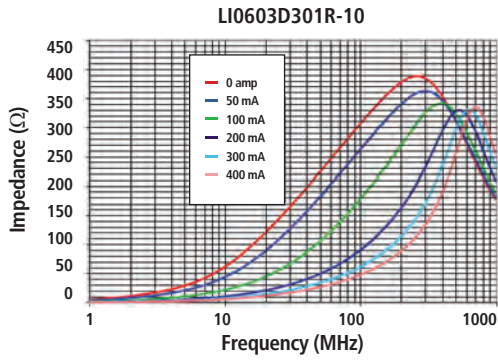

0603 Chip Bead Impedance Under DC Bias

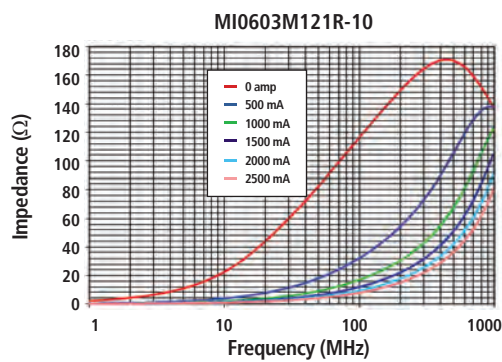
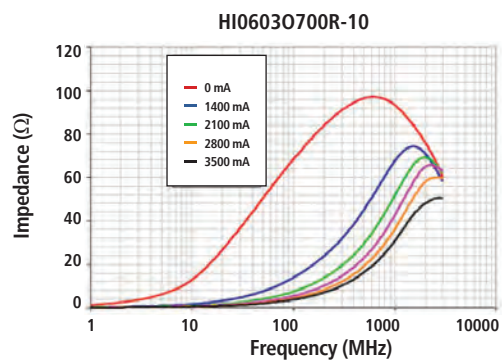
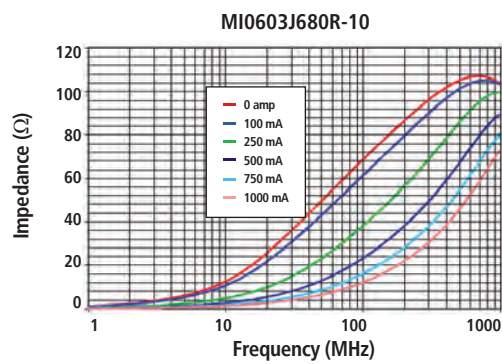
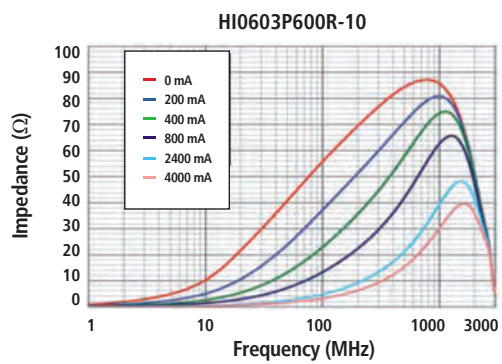
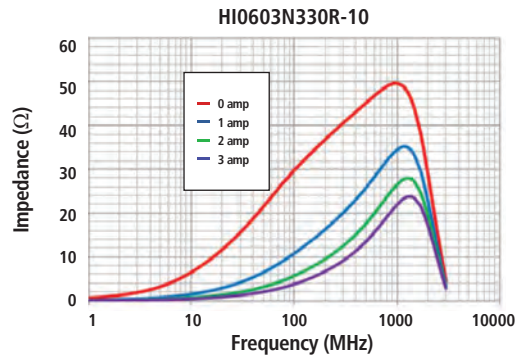
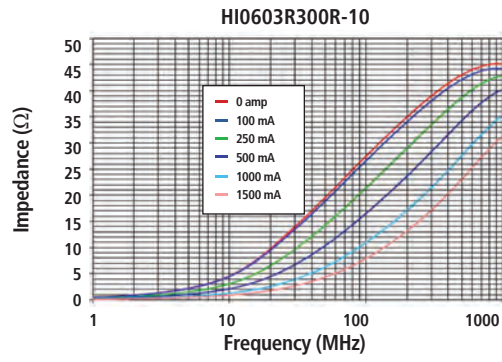
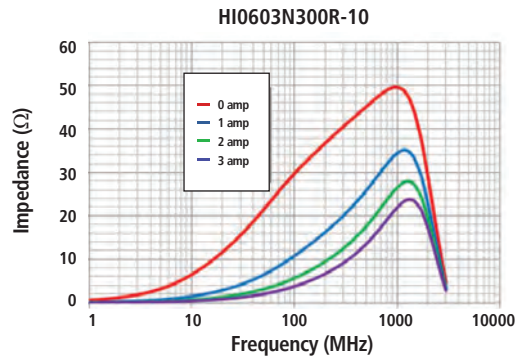
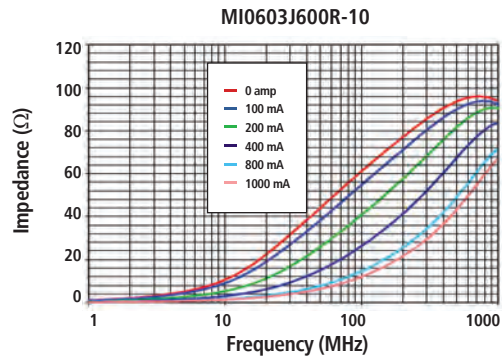

0603 Chip Bead Impedance Under DC Bias

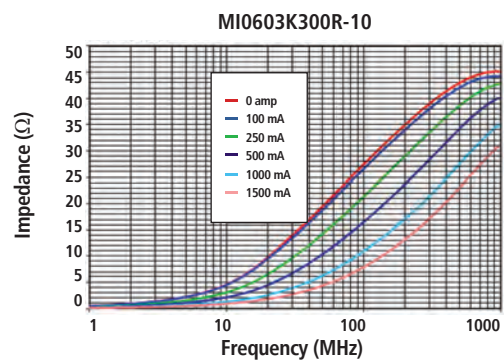
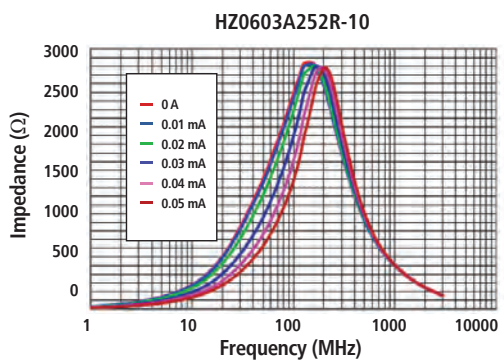
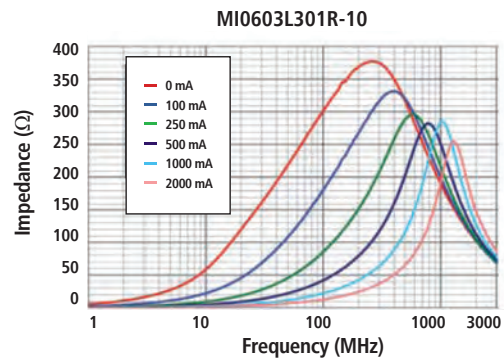
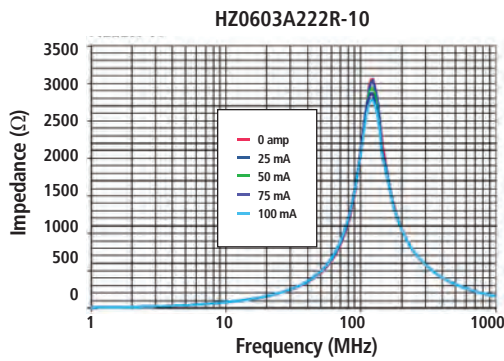
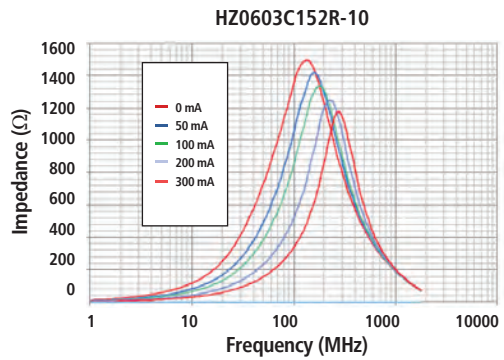
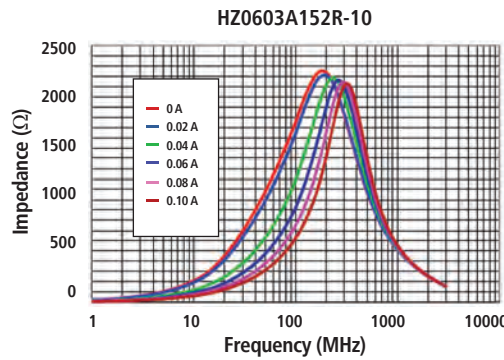
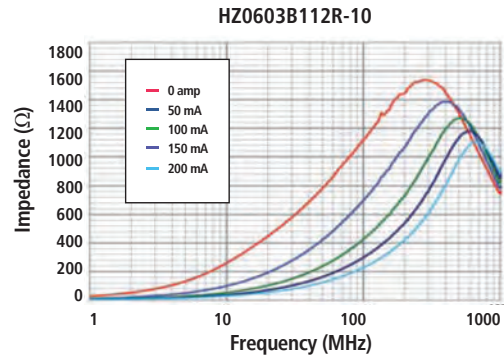
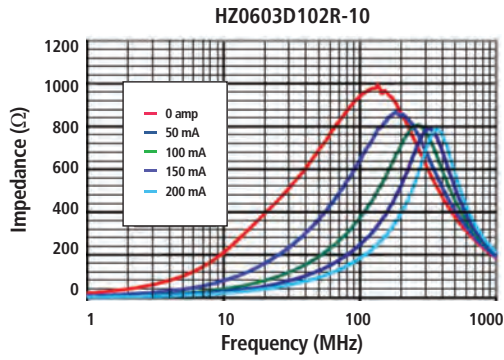

0603/0805 Chip Bead Impedance Under DC Bias

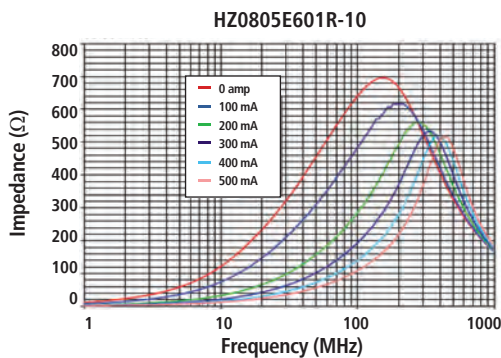
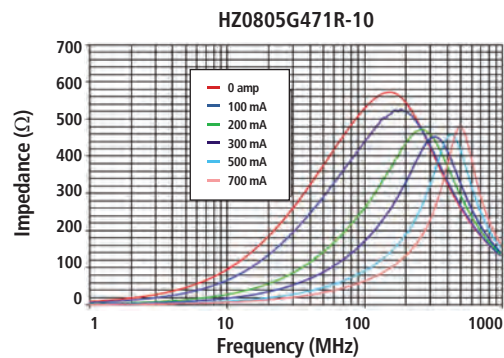
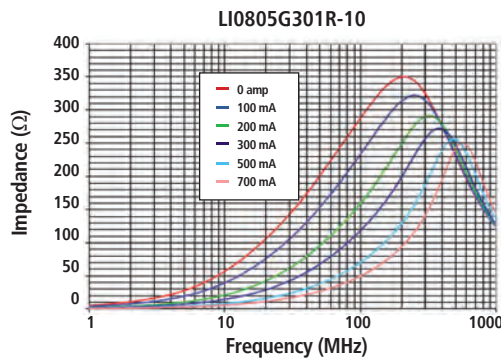
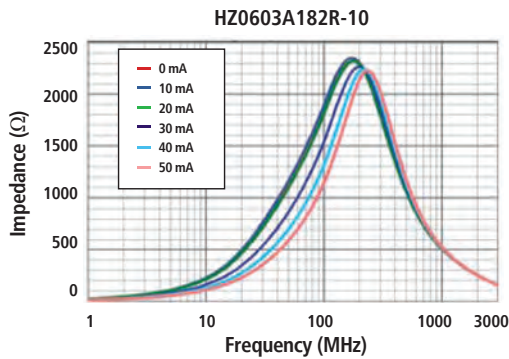
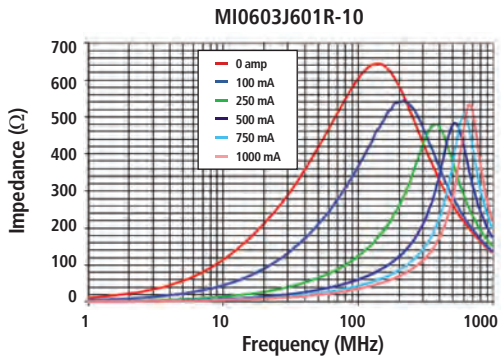
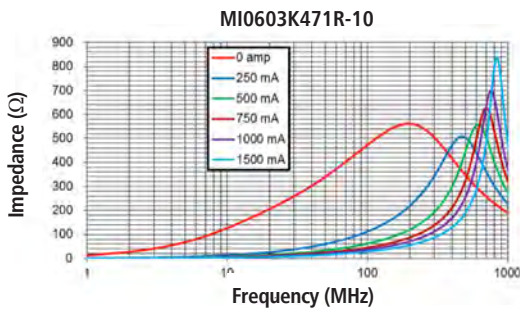
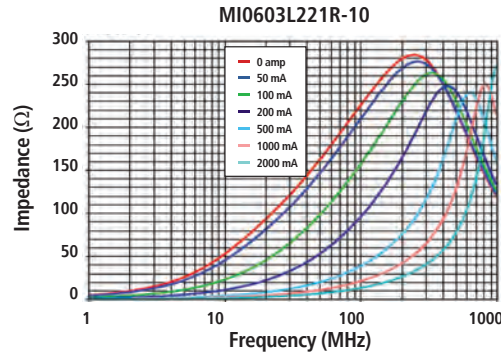
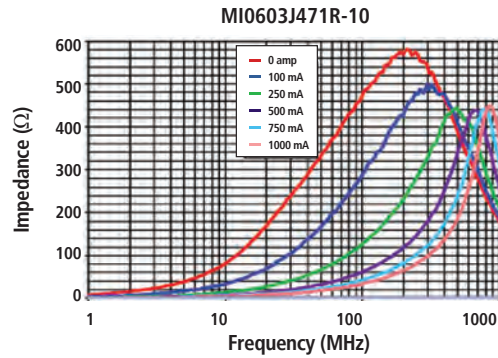

0805 Chip Bead Impedance Under DC Bias

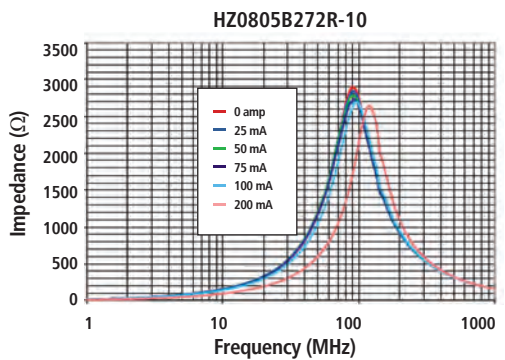
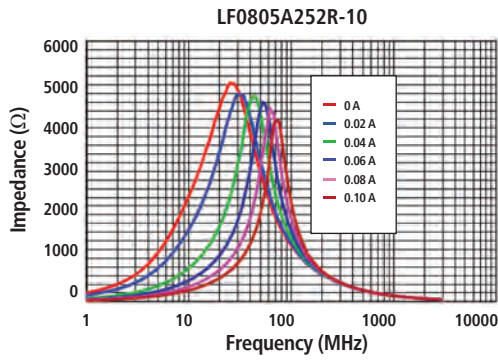
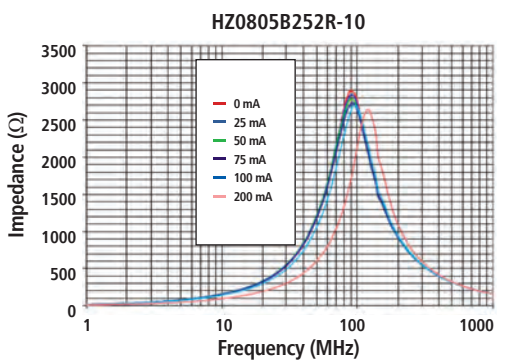
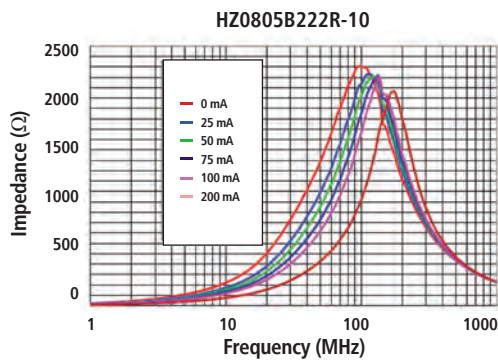
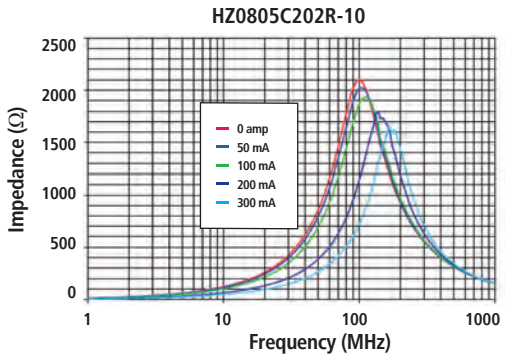
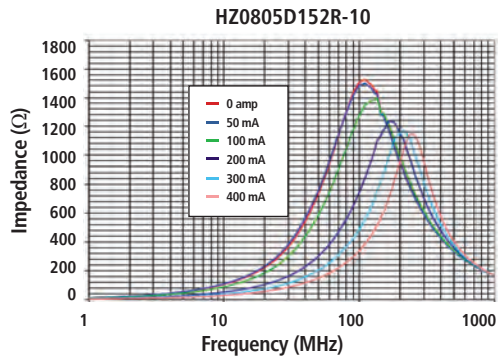
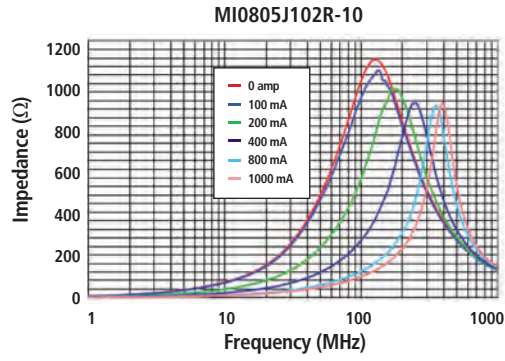
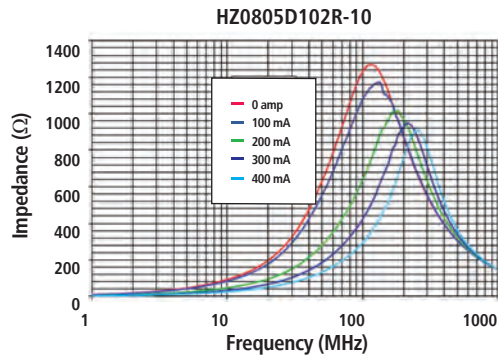

0805 Chip Bead Impedance Under DC Bias

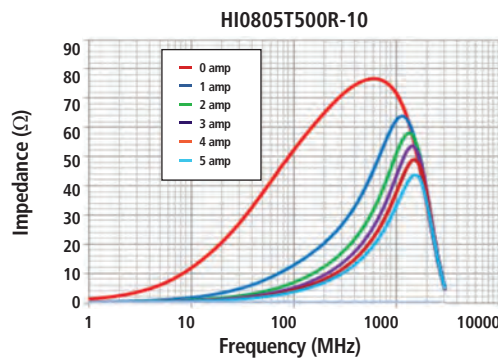
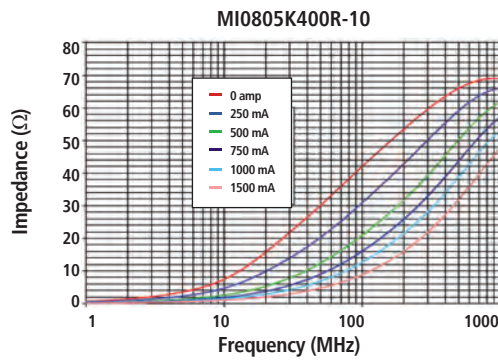
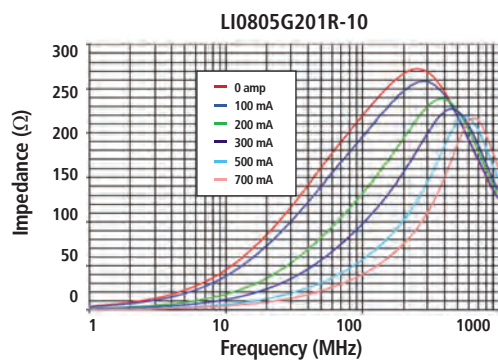
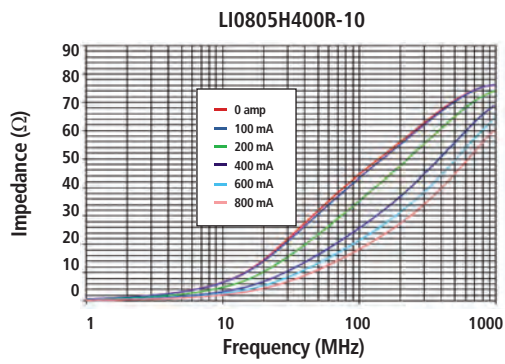
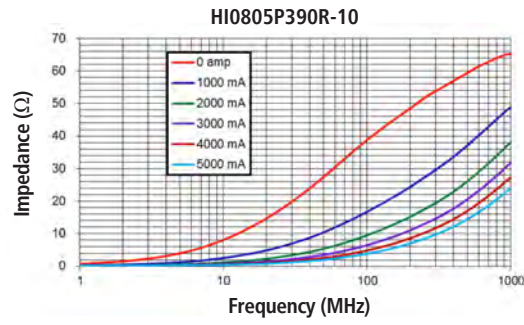
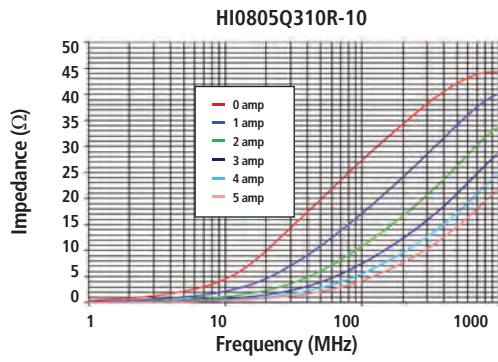
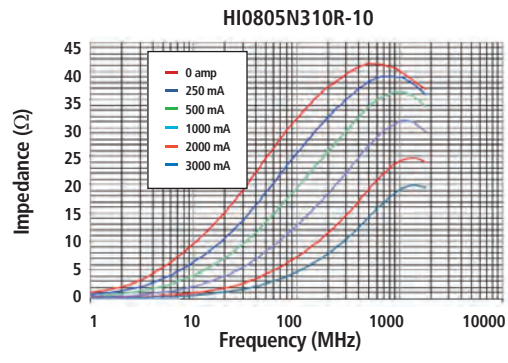
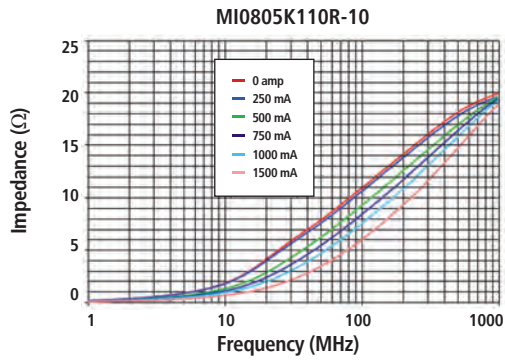

0805 Chip Bead Impedance Under DC Bias

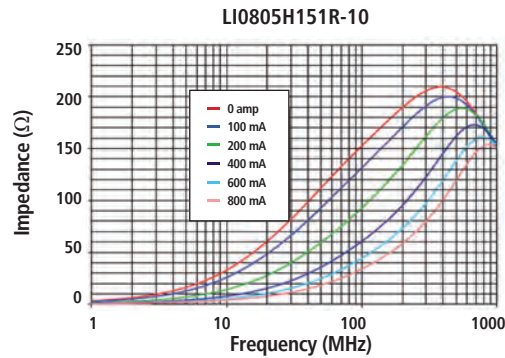
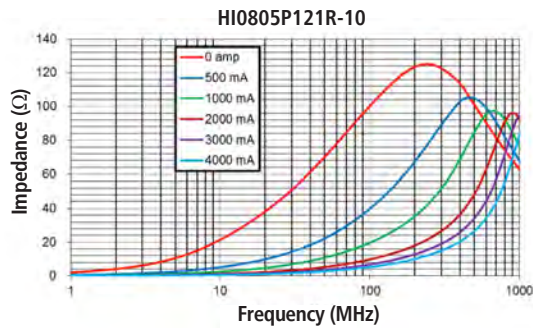
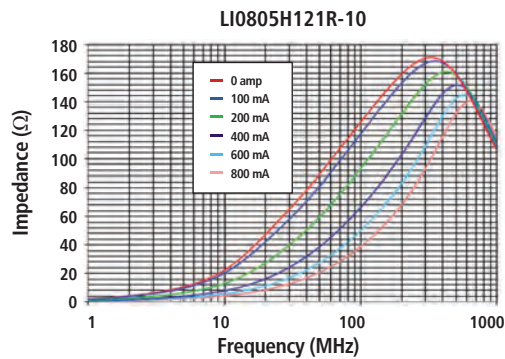
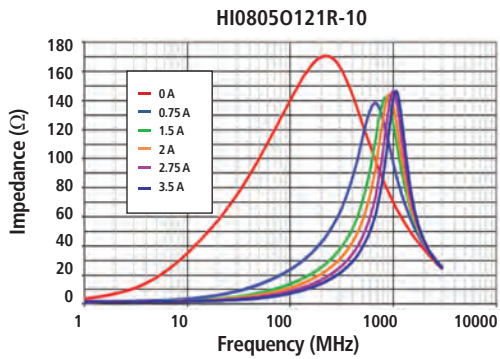
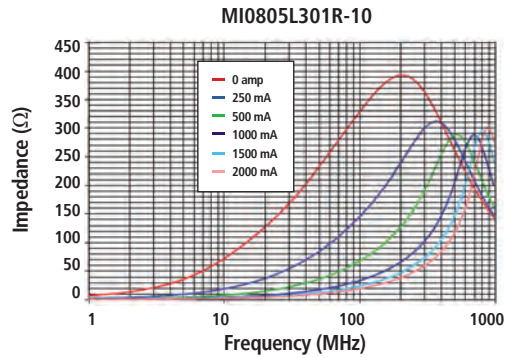
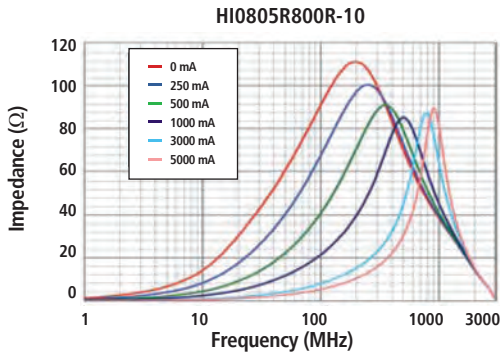
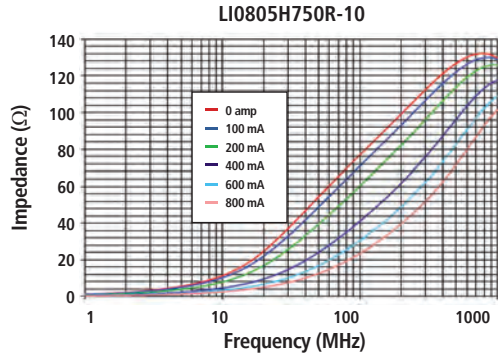
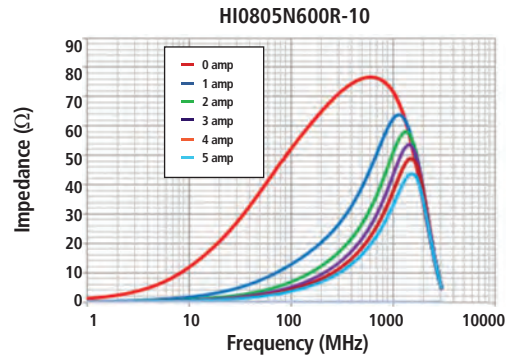

0805/1206 Chip Bead Impedance Under DC Bias

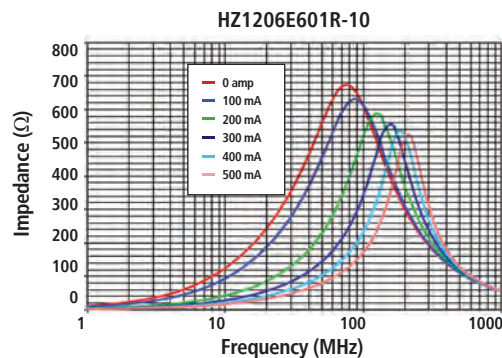
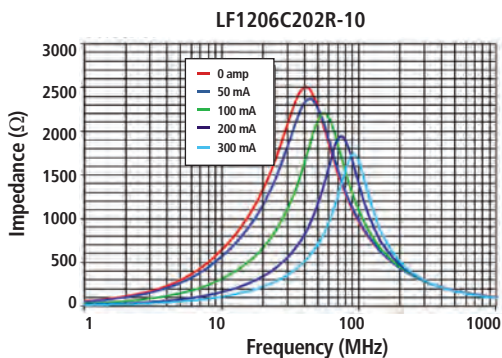
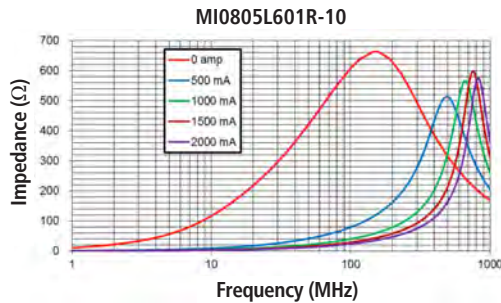
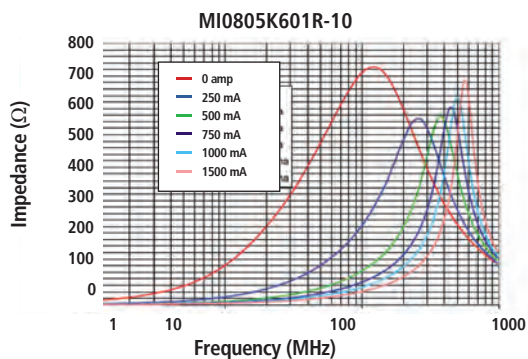
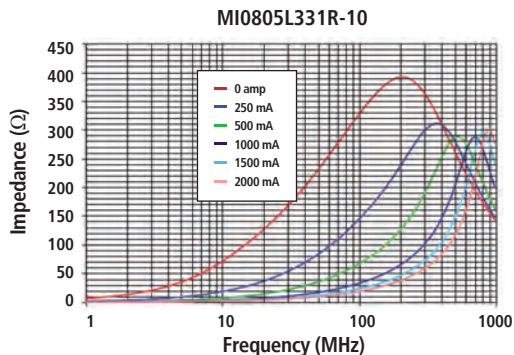
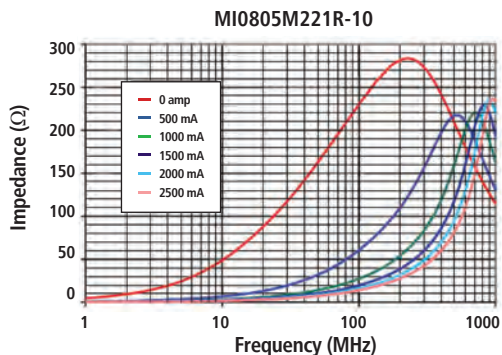
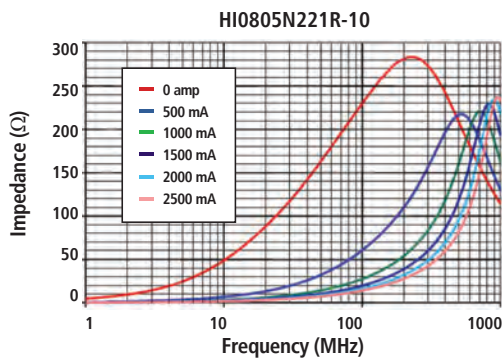
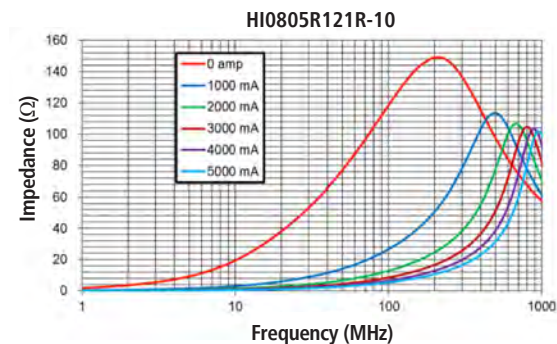

1206 Chip Bead Impedance Under DC Bias

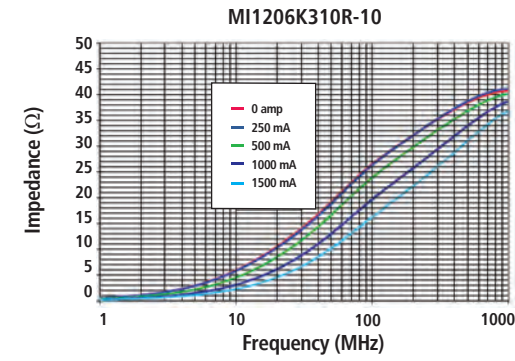
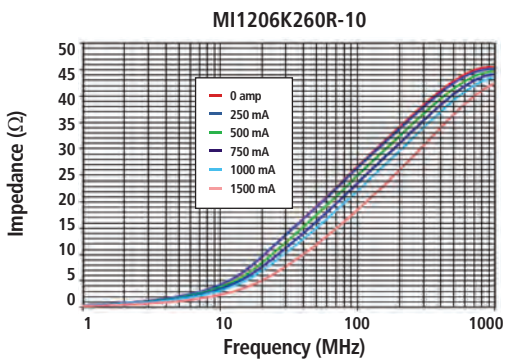
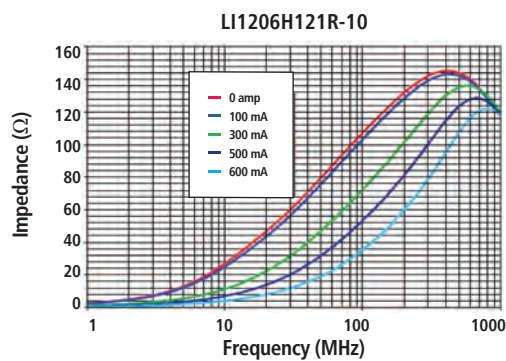
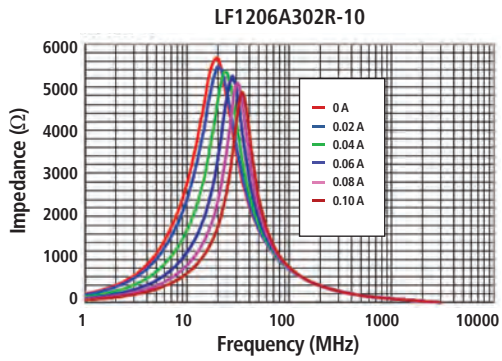
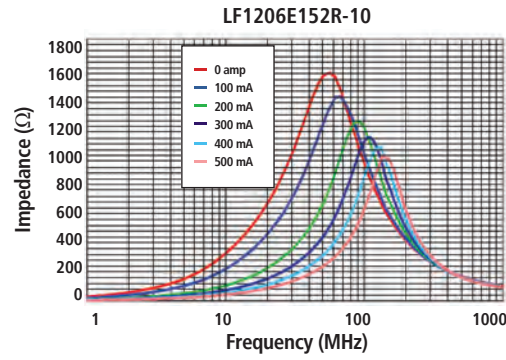
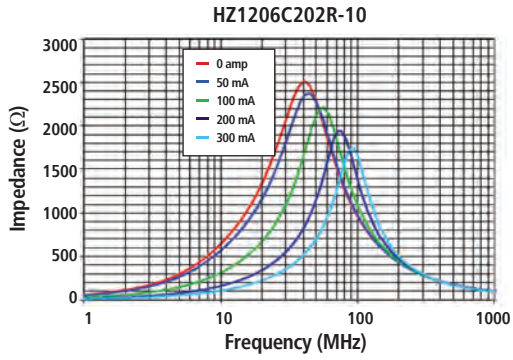
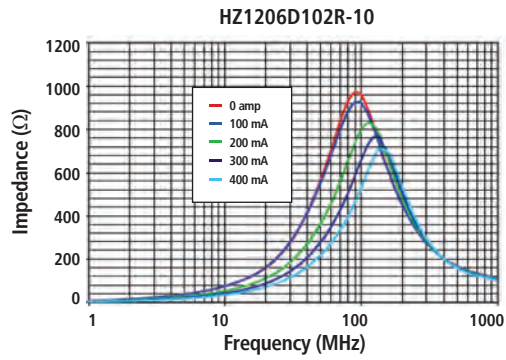
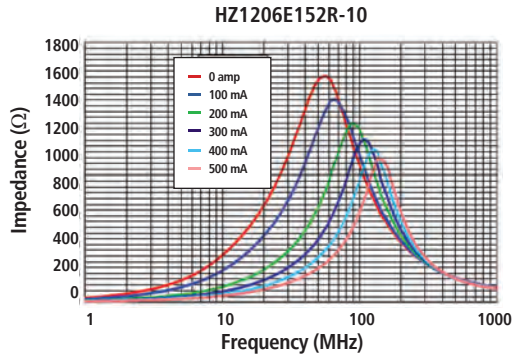

1206 Chip Bead Impedance Under DC Bias

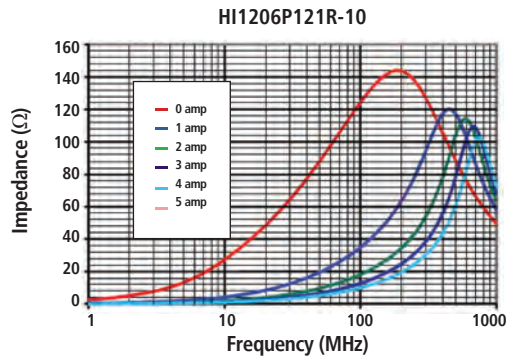
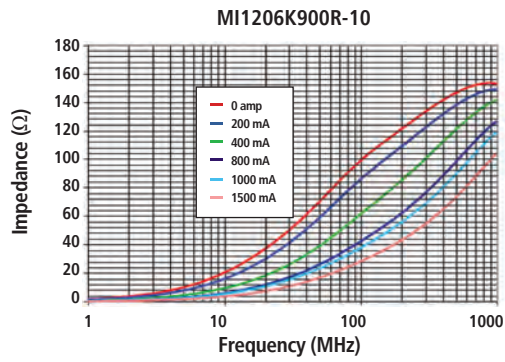
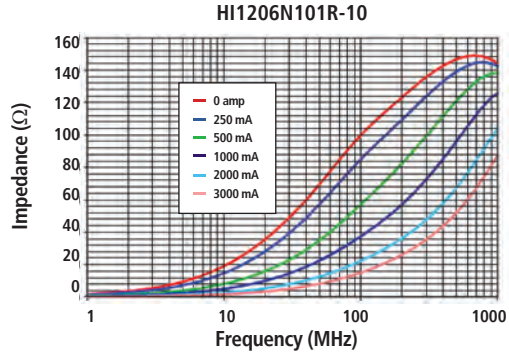
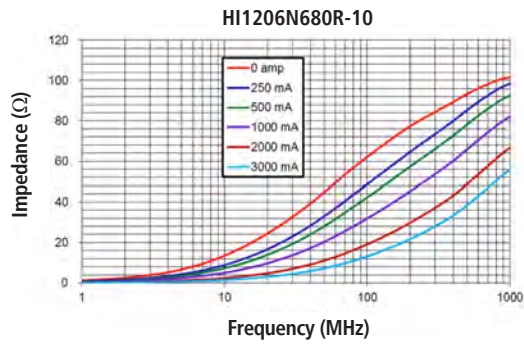
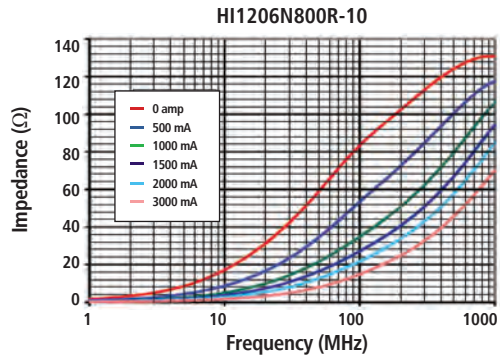
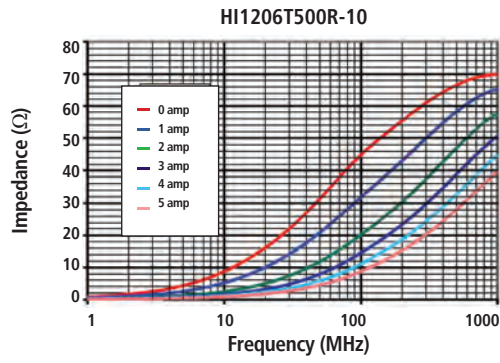

1206/1210/1612 Chip Bead Impedance Under DC Bias

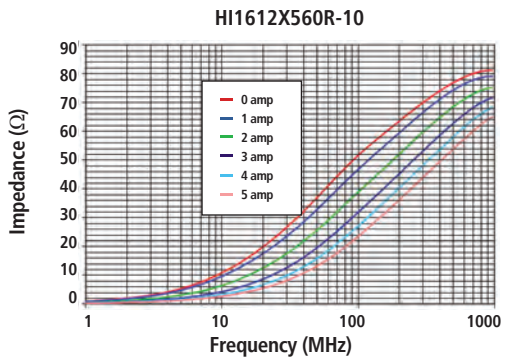
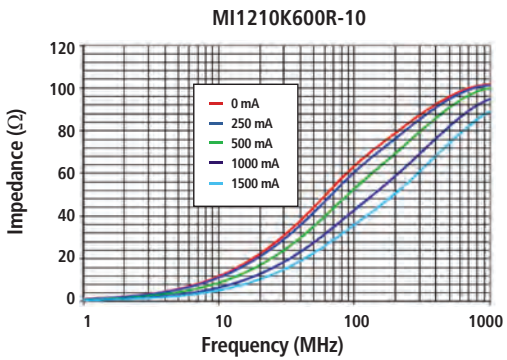
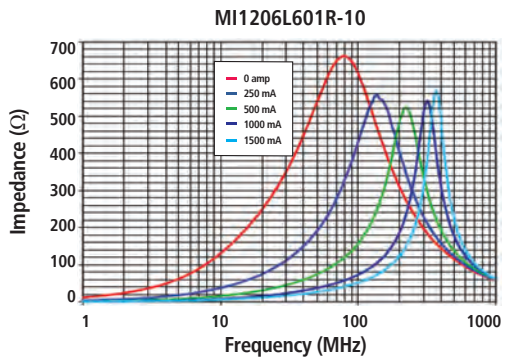
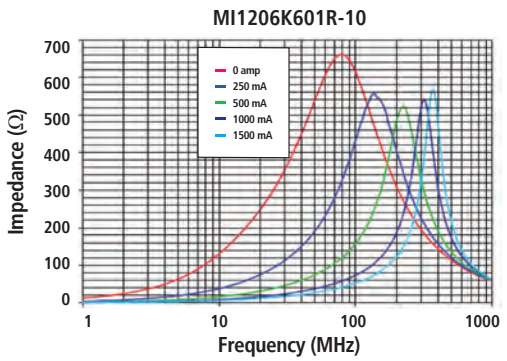
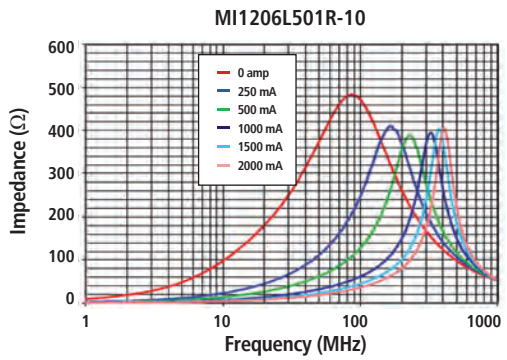
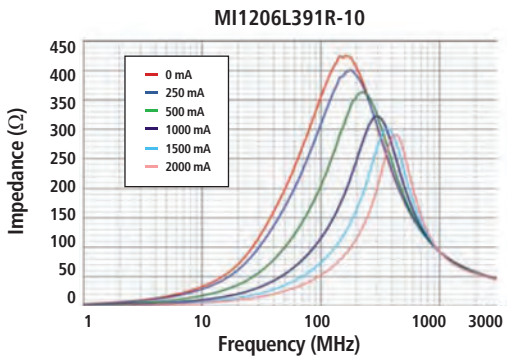
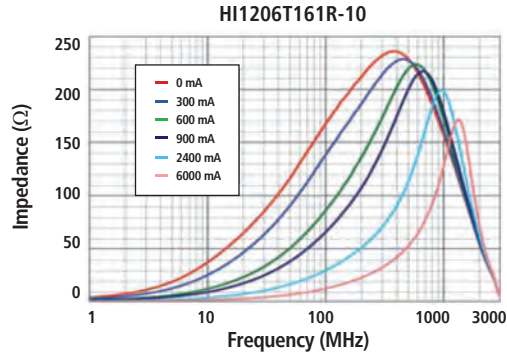
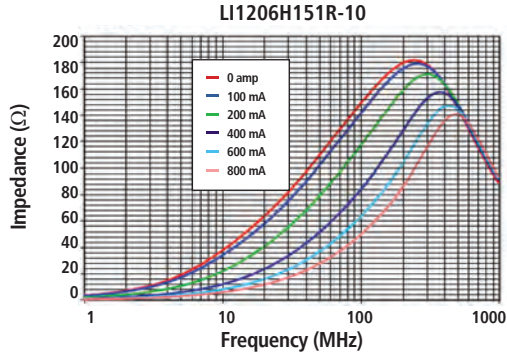

1806/1812 Chip Bead Impedance Under DC Bias

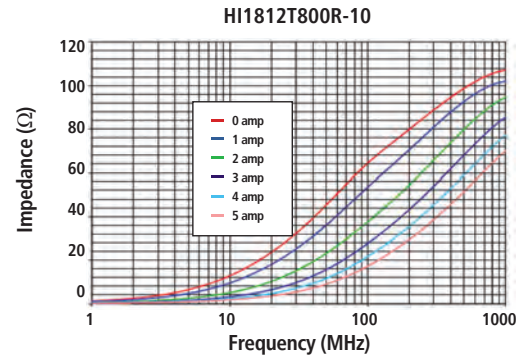
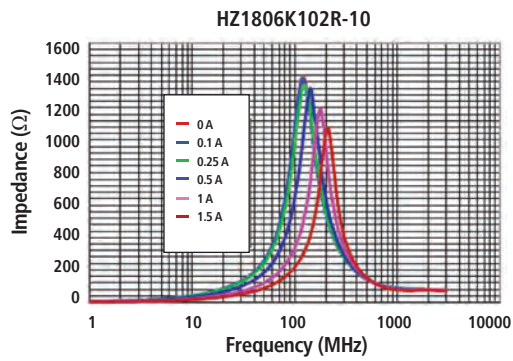
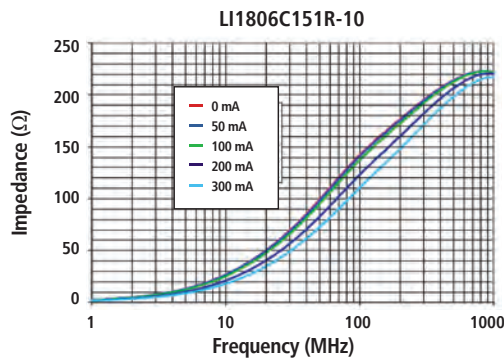
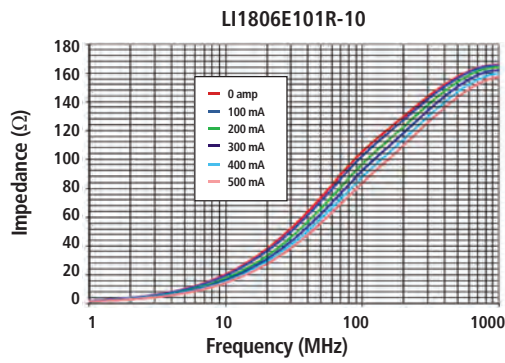
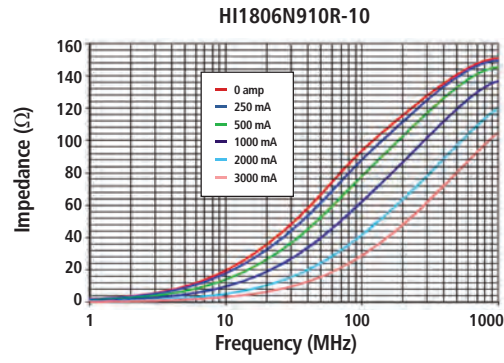
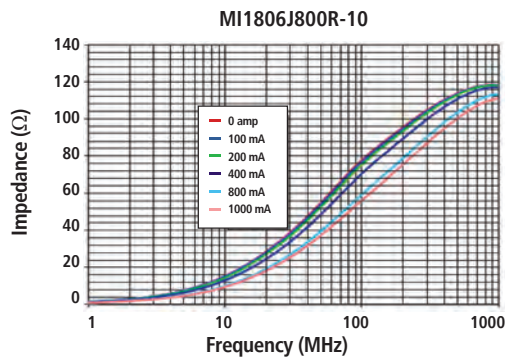
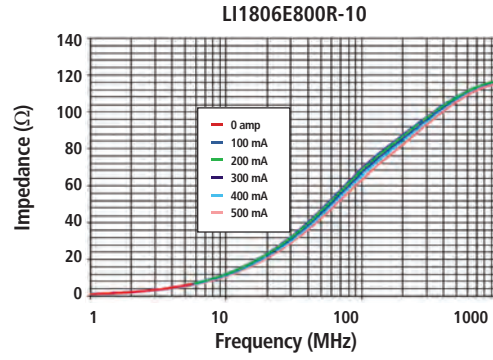
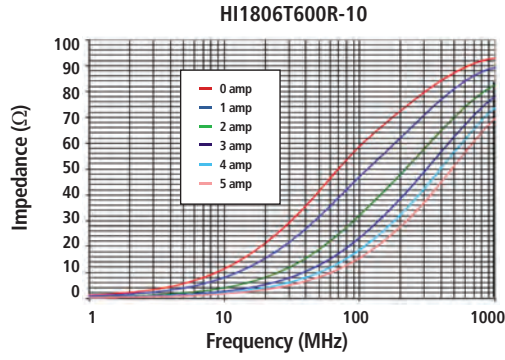

1812/2220 Chip Bead Impedance Under DC Bias

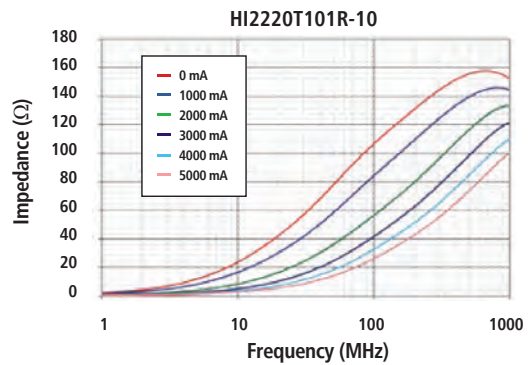
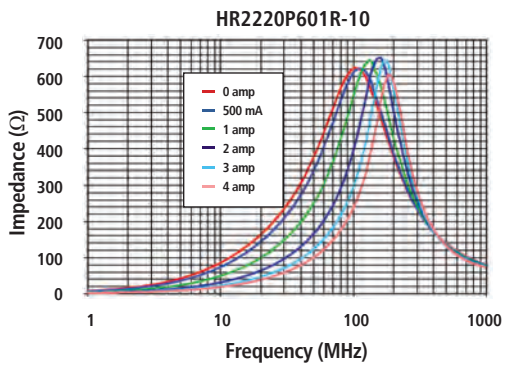
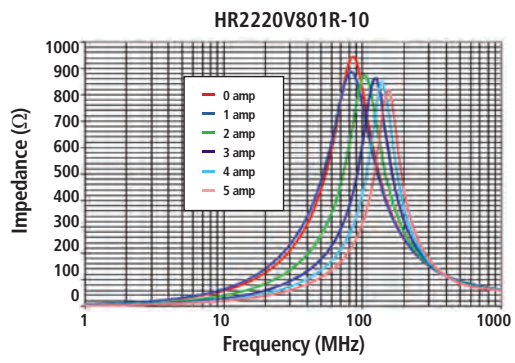
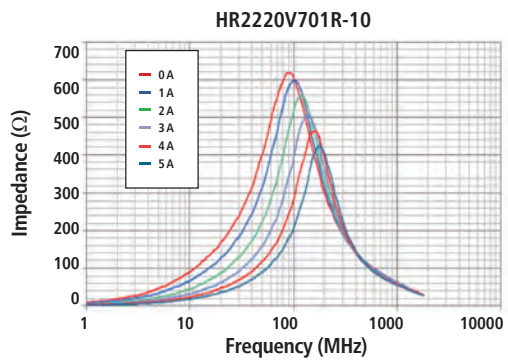
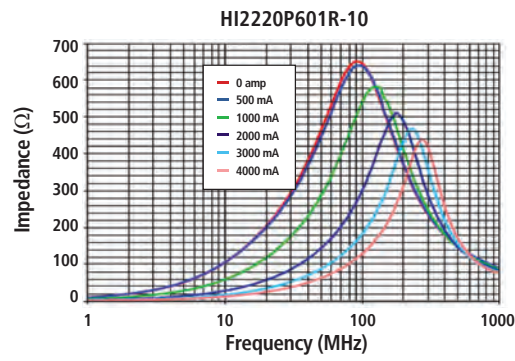
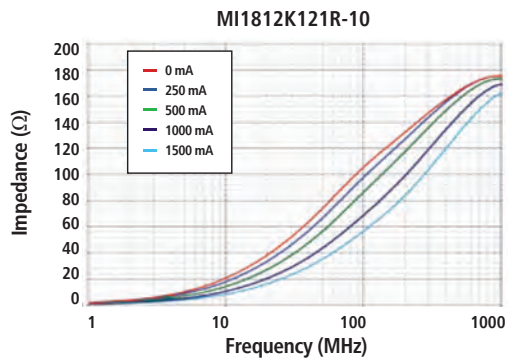
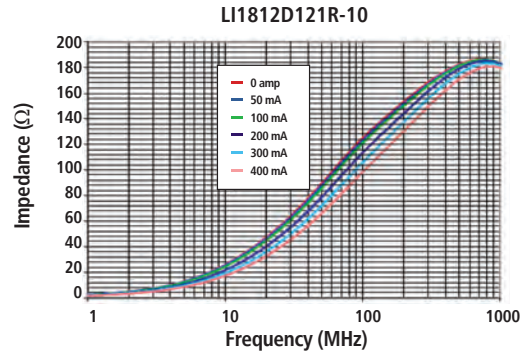
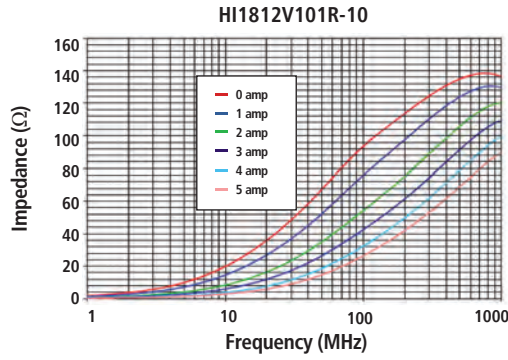

2220 Chip Bead Impedance Under DC Bias

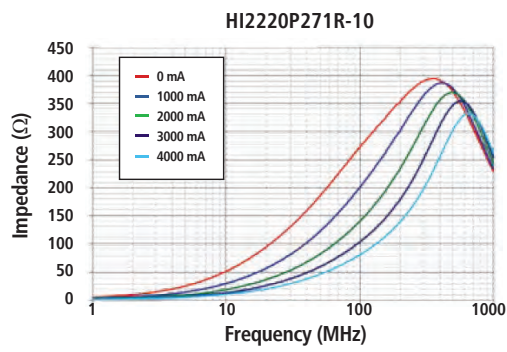
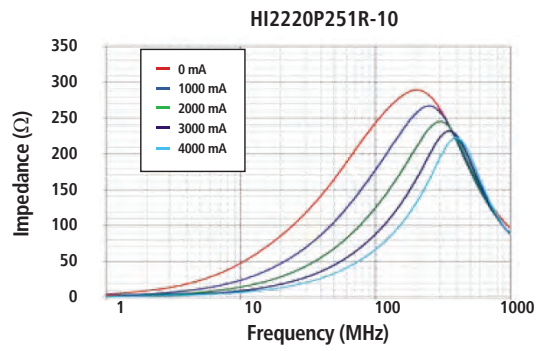
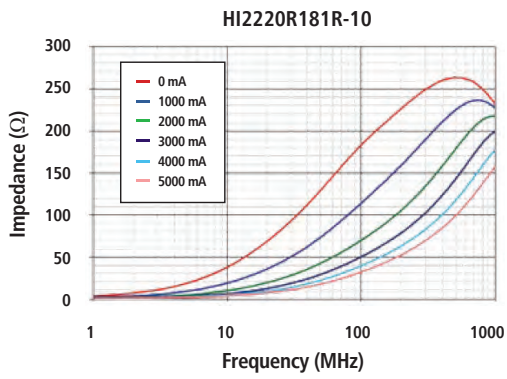
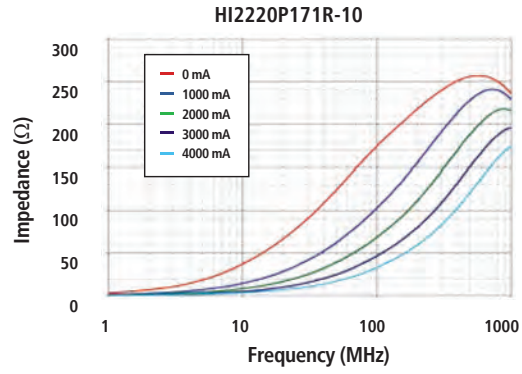
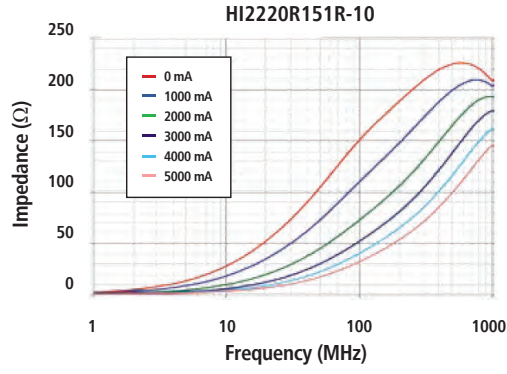

2220/3312 Chip Bead Impedance Under DC Bias

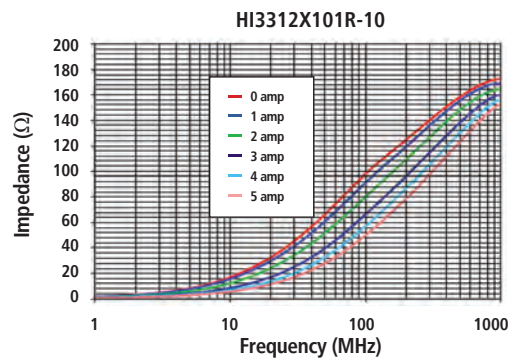
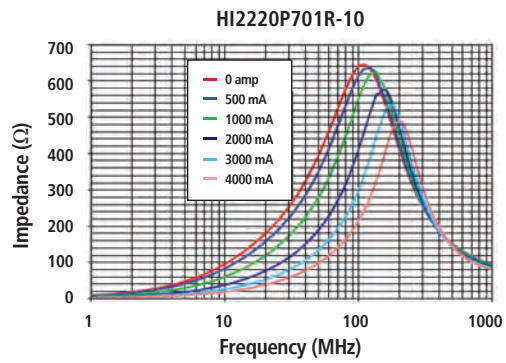
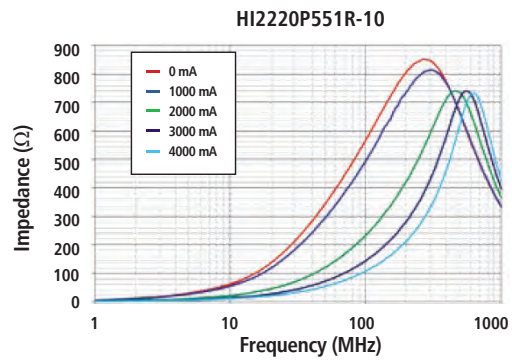
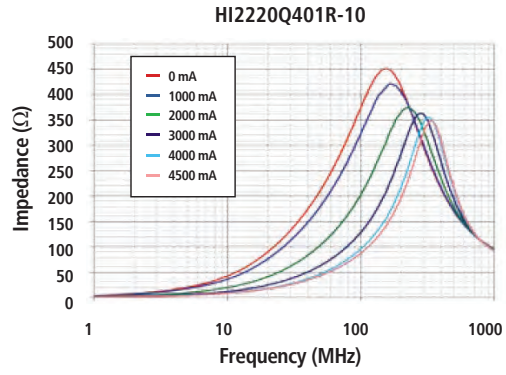
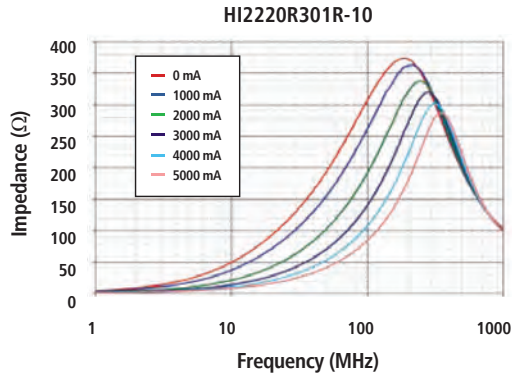

4 Line Array Impedance Under DC Bias

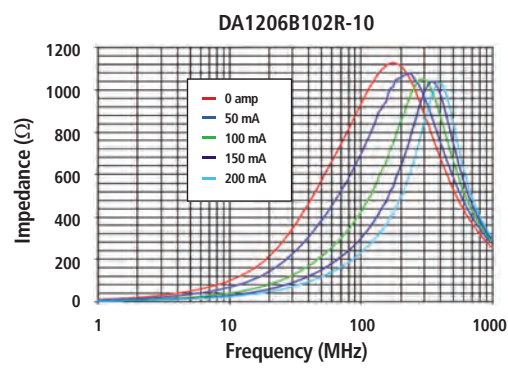
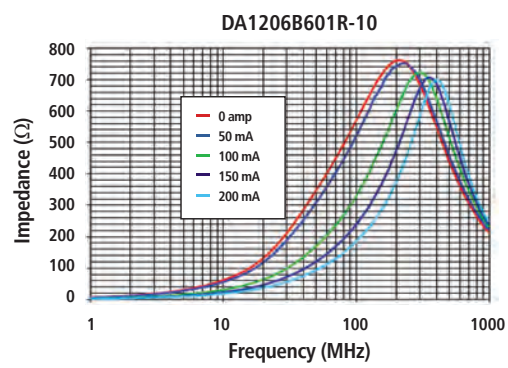
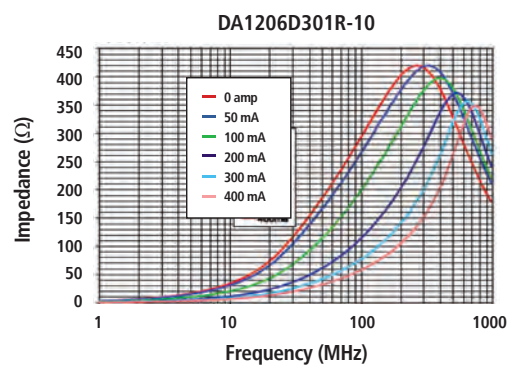
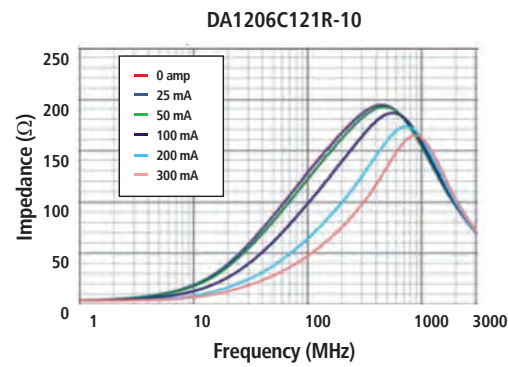
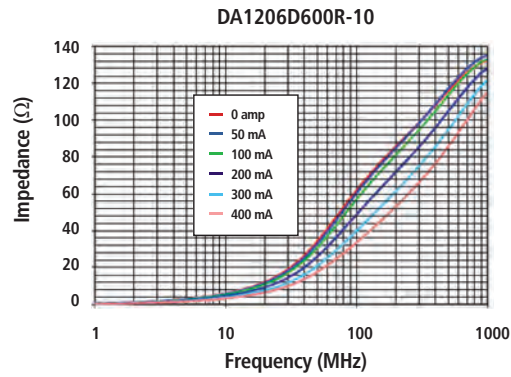
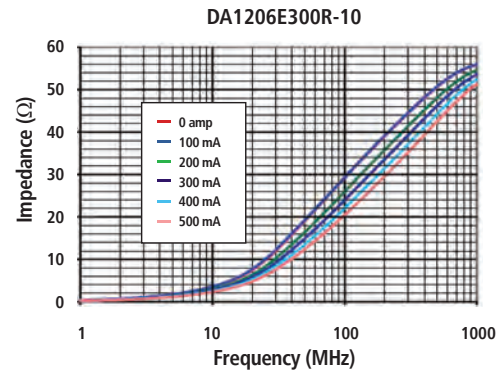

FERRITE EMI SMT
BEAD ASSEMBLIES



FEATURES  

- 10 Amps continuous operating current capability
- Very low RDC
- Broadband (28F) and (35F) parts available
- Lead free and RoHS compliant

PART NUMBERING SYSTEM

28	F	0121	-0	S	R	-10
Material Code	Product Code (EIA)	EIA Size Code	Selected Dimension Code	Additional Description	Packing Code	Additional Description

SMT BEAD ASSEMBLIES - POWER LINE

EIA PKG. SIZE	Metric Pkg. Size	Part Number	Typical Impedance (Ω)				Typical Peak Impedance (Ω)	Peak Impedance Frequency (MHz)	DCR MAX (Ω)	RATED I MAX (continuous) mA
			Z @ MHz	Z @ 100 MHz	Z @ 500 MHz	Z @ 1 GHz				
1612	4131	28F0121-0SR-10	30	48	53	53	54	800	0.00075	10,000
3312	8531	28F0121-1SR-10	60	96	115	114	117	833	0.001	10,000
3318	8545	28F0181-1SR-10	72	115	123	123	125	900	0.001	10,000

LOW FREQUENCY BEAD ASSEMBLIES - POWER LINE

EIA PKG. SIZE	Metric Pkg. Size	Part Number	Typical Impedance (Ω)				Typical Peak Impedance (Ω)	Peak Impedance Frequency (MHz)	DCR MAX (Ω)	RATED I MAX (continuous) mA
			Z @ MHz	Z @ 100 MHz	Z @ 500 MHz	Z @ 1 GHz				
1612	4131	35F0121-0SR-10	17	41	48	47	49	13	0.00075	10,000
3312	8531	35F0121-1SR-10	35	82	102	90	104	17	0.001	10,000

SMT Bead Assemblies Impedance Under DC Bias

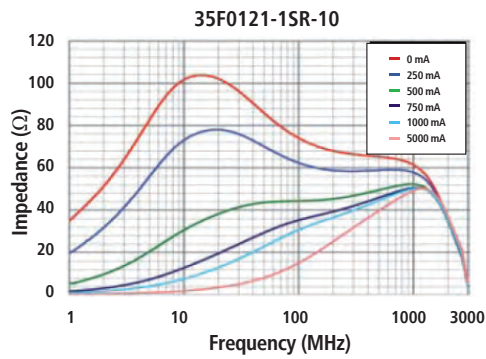
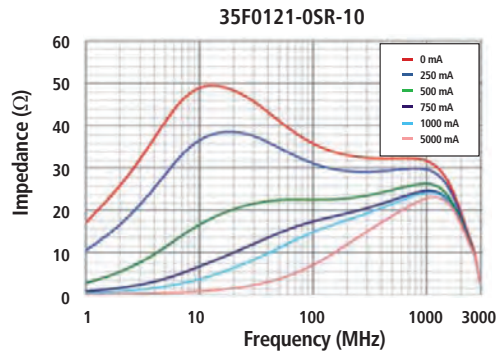
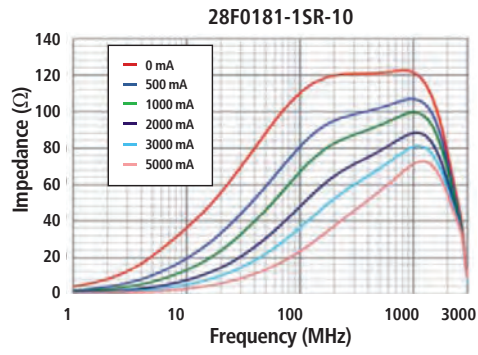
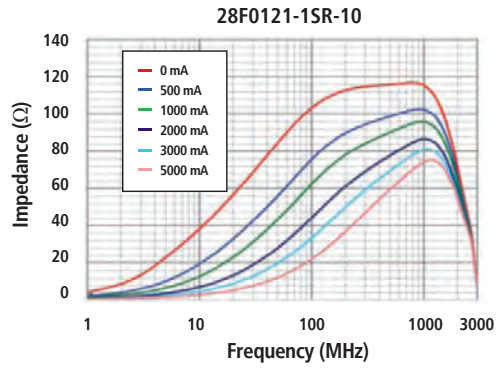
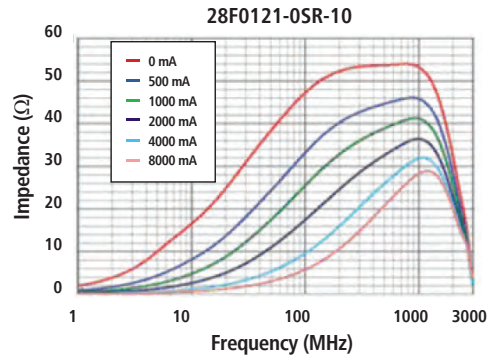

FERRITE EMI SMT
BEAD ASSEMBLIES

DIMENSION

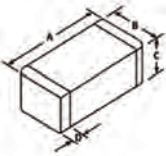
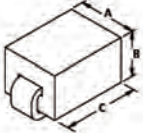
METRIC (EIA) PKG. SIZE	A mm (INCHES)	B mm (INCHES)	C* mm (INCHES)	D mm (INCHES)	MONOLITHIC CHIP BEAD
0603 (0201)	0.60 (0.023)	0.30 (0.011)	0.30 (0.011)	0.15 (0.006)	
1005 (0402)	1.01 (0.040)	0.50 (0.020)	0.50 (0.020)	0.30 (0.012)	
1608 (0603)	1.60 (0.063)	0.80 (0.031)	0.80 (0.031)	0.36 (0.014)	
2010 (0804)	2.00 (0.079)	1.00 (0.039)	0.50 (0.020)	0.025 (0.010)	
2012 (0805)	2.00 (0.079)	1.25 (0.049)	0.90 (0.035)	0.51 (0.020)	
3216 (1206)	3.20 (0.126)	1.60 (0.063)	1.10 (0.043)	0.51 (0.020)	
3225 (1210)	3.20 (0.126)	2.50 (0.098)	1.40 (0.055)	0.46 (0.018)	
4030 (1612)	4.06 (0.160)	3.05 (0.120)	2.28 (0.090)	0.46 (0.018)	
4516 (1806)	4.50 (0.177)	1.60 (0.063)	1.60 (0.063)	0.51 (0.020)	
4532 (1812)	4.50 (0.177)	3.20 (0.126)	1.40 (0.055)	0.46 (0.018)	
5650 (2220)	5.59 (0.220)	5.08 (0.200)	3.45 (0.136)	0.76 (0.030)	
8530 (3312)	8.50 (0.335)	3.05 (0.120)	2.28 (0.090)	0.51 (0.020)	
PART NUMBER	A mm (INCHES)	B mm (INCHES)	C* mm (INCHES)	D mm (INCHES)	FERRITE SMT BEAD ASSEMBLIES
-- F0121-0SR	3.05 (0.120)	2.54 (0.100)	4.06 (0.160)	--	
-- F0121-1SR	3.05 (0.120)	2.54 (0.100)	8.51 (0.335)	--	
-- F0181-0SR	4.57 (0.180)	2.54 (0.100)	8.51 (0.335)	--	

*C Dimension (height) may vary with current and impedance rating requirements.
Refer to part print for specific dimensions. Parts have no polarity.

COMMON MODE AND DIFFERENTIAL MODE EXPLANATION

Laird common mode chokes are the ideal components for EMI filtering of power and signal lines. These components withstand high DC currents without degradation of filtering performance that can occur with differential mode filters like small chip beads. Stable common mode chokes allow most signals to pass unaffected, yet filter the noise (EMI) from these circuits.

Switch mode power supplies are required for most advanced electronics because harmonics of the switch mode power supply can escape the power supply as EMI. The power delivery circuit often creates opportunities for unintended common mode current loops to form in the end product, even when using a "certified" or "regulation compliant" power supply. Installation of a common mode choke to the supply output can significantly reduce this common mode energy flow and help insure product performance and EMI regulatory compliance.

Small ferrite chip beads or inductors are degraded by the power supply output. However, common mode chokes continue their high performance regardless of the high power currents that might flow or spike in the circuit.

Modern systems are frequently an interconnection of functional blocks and connections made by cables or wiring harnesses. These interconnections often present the opportunity for common mode current loops between devices that can lead to EMI regulatory failure. The addition of a common mode choke before the connector filters these common mode currents while allowing the desired signals to pass unaffected. The result is effective communication between devices, reliable product and system operation and product EMI regulatory compliance.

Most well-designed power and signal circuits present no EMI caused from intended currents. As an example, at 30 MHz a pair of traces or wires 1 m long, separated by 1.3 mm, require over 20 mA differential current imbalance to exceed 100 $\mu\text{V}/\text{m}$ radiation 3 meters away. However, unintended, unforeseen common mode currents can exceed 100 $\mu\text{V}/\text{m}$ radiation with only 8 μA common mode current flow! Suppression of these tiny common mode currents is often crucial to assuring EMI regulatory compliance and reliable product performance. Ferrite common mode chokes operate by acting on the magnetic fields surrounding a pair of conductors.

Black arrows represent differential (normal) mode. Red arrows represent common mode.

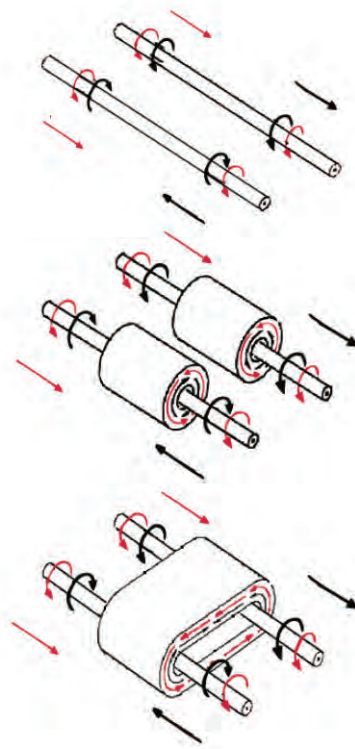

Two conductors used in a standard "differential" transmission circuit create magnetic fields surrounding the conductors. These magnetic fields flow around the conductors in the directions depicted by the black arrows.

Likewise, common mode currents generate magnetic fields surrounding the conductors. The red arrows depict the common mode current path and the associated flux paths around the wires.

The same two wires shown above have been fitted above with two separate ferrite EMI cores in a differential-mode configuration with one core per line. In this application, each core must contain the total magnetic flux resulting from both the differential mode (intended) current and the common mode (unintended) by the intended current. Differential mode filters (like small chip beads) are not stable under significant load.

The same two wires have now been fitted with a ferrite EMI core in a common mode configuration; a single core with both lines through a common opening in the core. The differential mode (black) fields in the core are now equal and opposite, which yields a net flux seen by the core of approximately zero. Saturation is no longer an issue, and a much smaller ferrite core/choke can be used. The field from the common mode noise (red arrows) is additive and is the only remaining flux to be deflected by the core. The common mode choke configuration applies to both cable cores and board level components. Common mode chokes are stable under load.

COMMON MODE CHOKE FAMILY

PART SERIES	SPECIAL FEATURES	EIA PACKAGE SIZE	IMPEDANCE (Z) Ω @ 100 MHz	RATED I MAX (CONTINUOUS) mA	PEAK IMPEDANCE (Z) FREQUENCY	# OF SINGLE LINE PAIRS OR CHOKES
CM 05	USB 2.0, Low Normal Mode Z	0805	90-370	100-400	1 GHz - 1.4 GHz	1
CH 05	HDMI High Speed Signal	0805	90	400	2000	1
CF Beads	Normal Signal, Small Package	0504-0805	67-220	300-400	180-583	1
CM 21	High Current, Low Profile	2021-3421	33-60	15,000	1GHz	1
CM 22 Array	Firewire, Gigabit Ethernet	2722-5022	45-200	5,000	200 MHz - 3 GHz	2,3,4
CM 32 Array	High Current, High Frequency	3032- 6032	120-300	8,000	150 MHz - 2 GHz	2,3,4
CM 40 Array	High Current, Low to High Frequency	3440-5740	170	20,000	1 GHz	1,2
CM 41	Ultra High Current, Low to High Frequency	5441	90-160	75,000	600 MHz - 700 MHz	1
CM 44	3 Line Power	4440	110	20,000	500 MHz	3
CM 45	2 & 4 Line Power	2545-4545	130-170	10,000	500 MHz - 1 GHz	1,2
LF CM	Low Frequency	1812-5740	100-3500	200-20,000	3 MHz - 80 MHz	1

IMPEDANCE TEST FOR COMMON MODE CHOKES

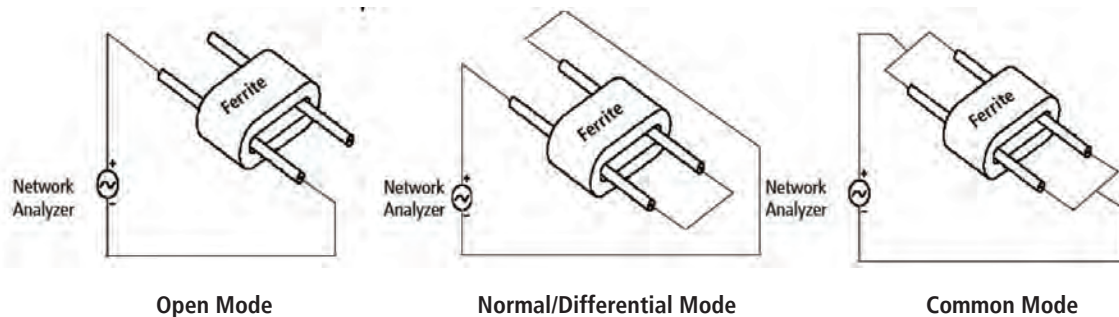

Open-Mode Impedance Measurement -

The open-mode impedance characterizes the impedance of only a single conductor in the ferrite common mode choke.

Normal (Differential) Mode Impedance Measurement

The normal mode impedance characterizes the impedance presented by the common mode choke to the normal (differential) signals present in the circuit. The test circuit represents the forward and return paths through the device.

Common Mode Impedance Measurement -

The common mode impedance characterizes the impedance presented by the choke to the unintended common mode currents that might flow in the circuit and cause EMI failures. Since this current flows in both conductors, it is necessary to short the conductors on each side of the choke so that test current flows equally through both conductors.

COMMON MODE CHOKES

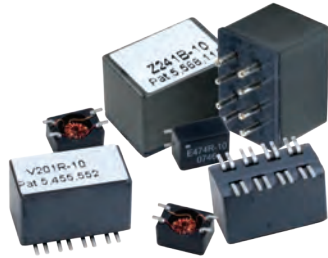

FEATURES

- Wire wound SMT and through hole structure rated current up to 75 Amps
- Low DCR with small package
- Stable performance under load bias
- Excellent impedance vs frequency feature
- Small size and high reliability
- For power, low frequency and high frequency signal lines
- For USB, HDMI, 1394, DVI, S-ATA, LVDS signal line applications
- Suitable for power saving especially for portable application

PART NUMBERING SYSTEM

CM	0805	D	900	R	-10
Product Series Code	EIA Size Code	Rated Current Code	Inductance Value Code	Packing Code	Additional Description

HIGH SPEED SERIAL INTERFACE COMMON MODE CHOKE

APPLICATION	TYPE	PART NUMBER	TYPICAL IMPEDANCE (Ω)				TYPICAL PEAK IMPEDANCE (Ω)	PEAK IMPEDANCE FREQUENCY (MHz)	DCR MAX (Ω)	RATED I MAX (CONTINUOUS) (mA)
			Z @ 25 MHz	Z @ 100 MHz	Z @ 500 MHz	Z @ 1 GHz				
USB2.0/LVDS	Wirewound (For 2 lines)	CM0805D900R-10	24	90	340	435	445	1405	0.3	400
		CM0805C161R-10	49	160	540	684	684	1000	0.35	300
		CM0805C221R-10	57	220	570	720	724	1147	0.4	300
		CM0805B361R-10	95	360	1080	1310	1343	913	0.4	280
		CM0805A371R-10	186	370	730	878	878	1000	0.5	100
		CM0805B501R-10	185	500	895	980	1015	833	0.5	250
		CM0805C601R-10	265	600	1080	1227	1264	782	0.375	250
HDMI/DVI/SATA	Wirewound (For 2 lines)	CH0805D900R-10	48	90	249	339	494	2000	0.3	400
		CM1206A601R-10	200	600	1450	980	1530	580	0.8	260
		CM1206C161R-10	81	160	358	555	718	2177	0.4	340
USB/Signal Line	Multilayer (For 2 lines)	CF0504C900R-10	28	90	210	148	217	583	0.6	300
		CF0504C121R-10	33	120	250	145	250	500	0.6	300
		CF0805D670R-10	24	67	196	98	166	510	0.4	400
		CF0805D900R-10	32	90	210	106	220	435	0.4	400
		CF0805D121R-10	36	120	240	103	260	397	0.4	400
		CF0805D181R-10	48	180	123	42	277	210	0.5	400
		CF0805C221R-10	50	220	109	33	296	180	0.5	300

COMMON MODE CHOKES

CM0805D900R-10

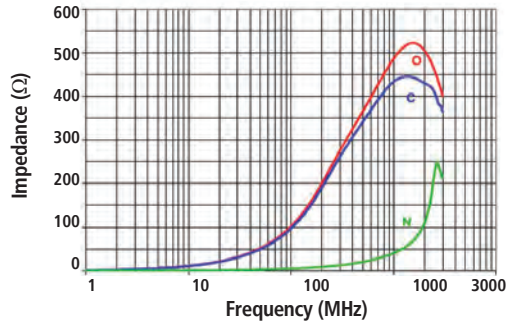

CM0805C161R-10

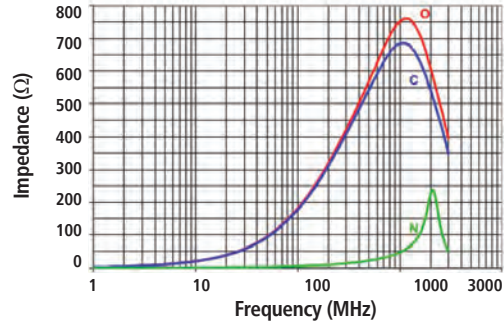

CM0805C221R-10

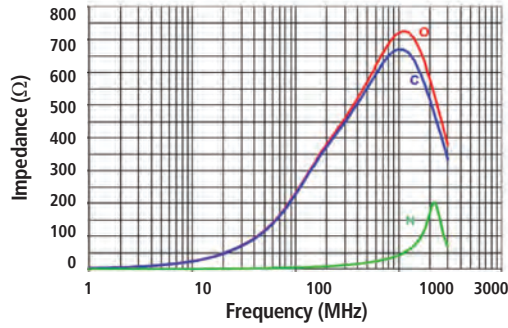

CM0805B361R-10

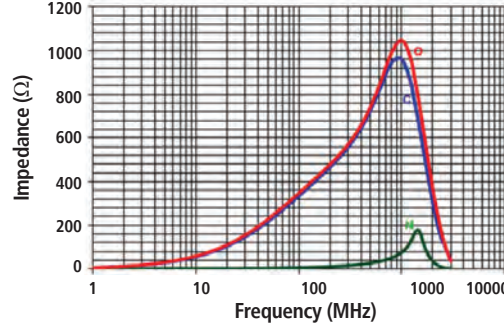

CM0805A371R-10

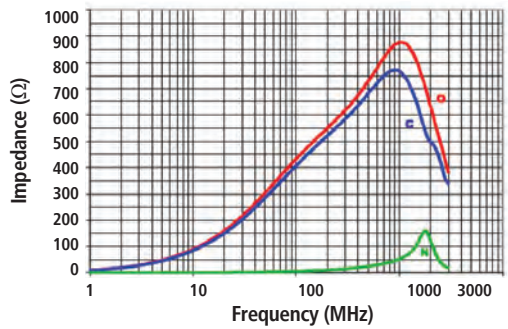

CM0805B501R-10

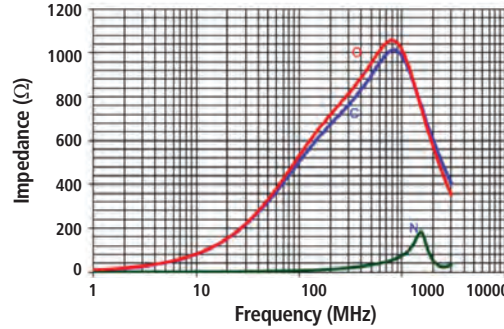

CM0805C601R-10

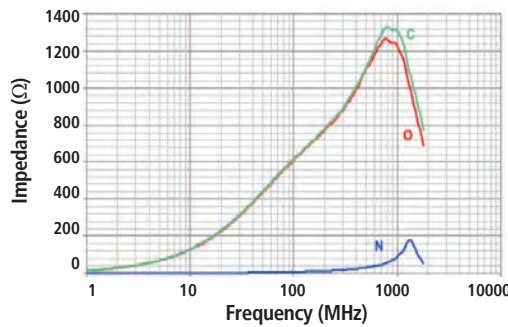

CH0805D900R-10

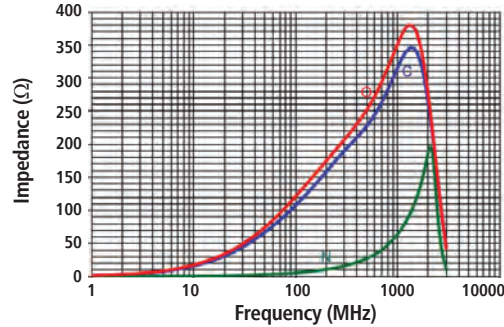

COMMON MODE CHOKES

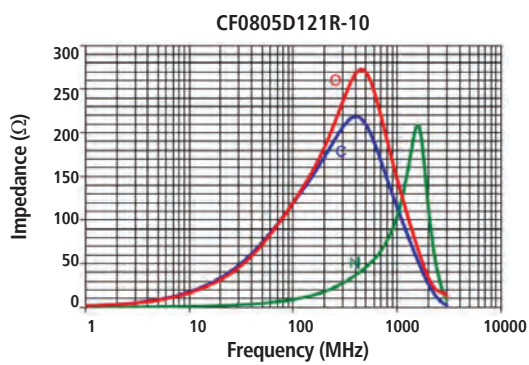
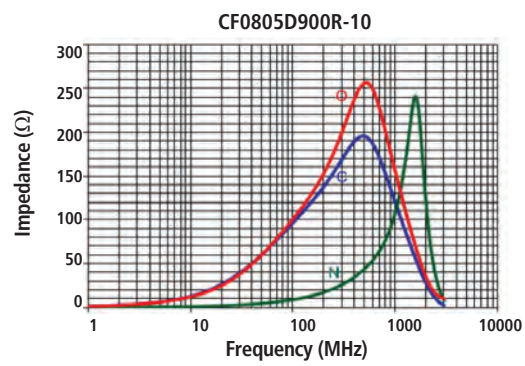
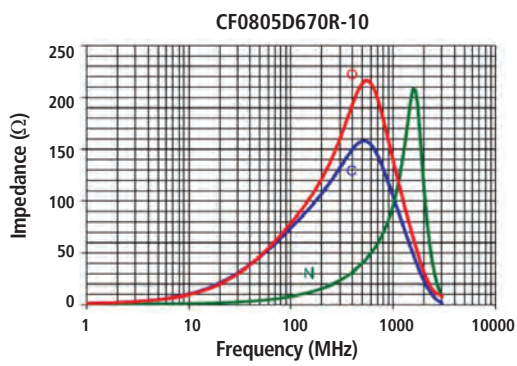
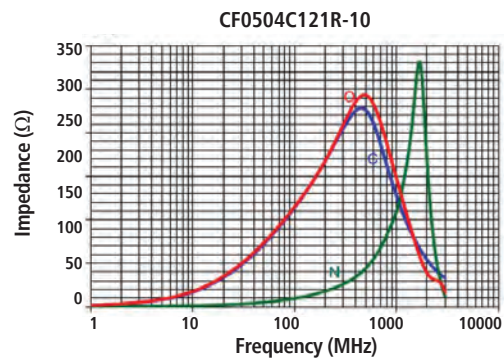
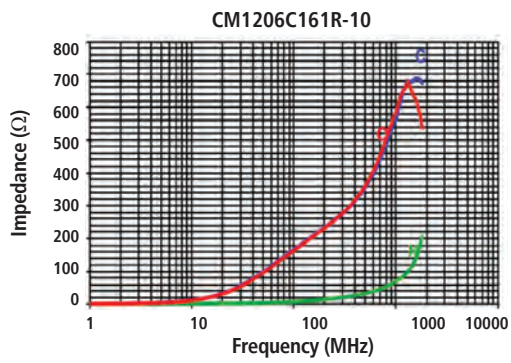
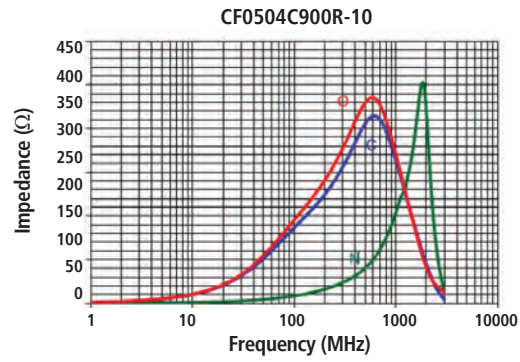
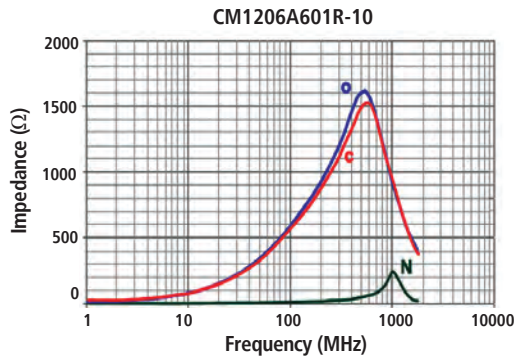

COMMON MODE CHOKES

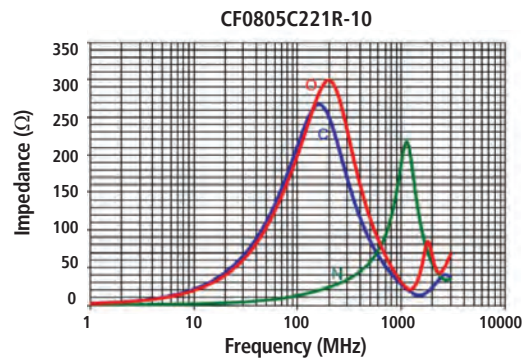
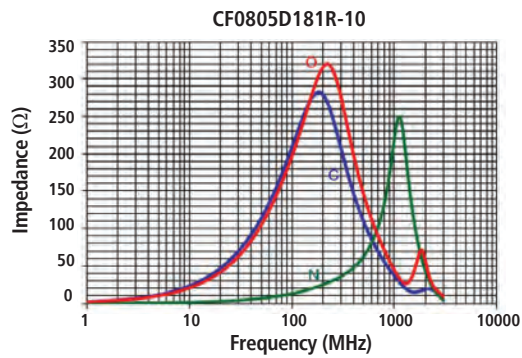

32

DIMENSION

PART NUMBER	EIA PKG SIZE	METRIC PKG SIZE	A mm (INCHES)	B mm (INCHES)	C mm (INCHES)	D mm (INCHES)	D1 mm (INCHES)	E mm (INCHES)	
CM0805 CH0805	0805	2012	2.00 (0.079)	1.20 (0.047)	1.20 (0.047)	-	-	-	
CF0504	0504	1210	1.25 (0.049)	1.00 (0.039)	0.82 (0.032)	0.30 (0.012)	0.20 (0.008)	0.50 (0.020)	
CF0805	0805	2012	2.00 (0.079)	1.25 (0.049)	1.00 (0.039)	0.30 (0.012)	-	0.40 (0.016)	

POWER LINES COMMON MODE CHOKE



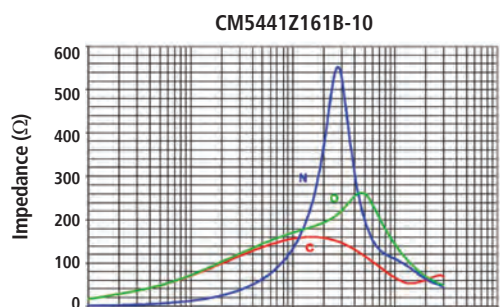
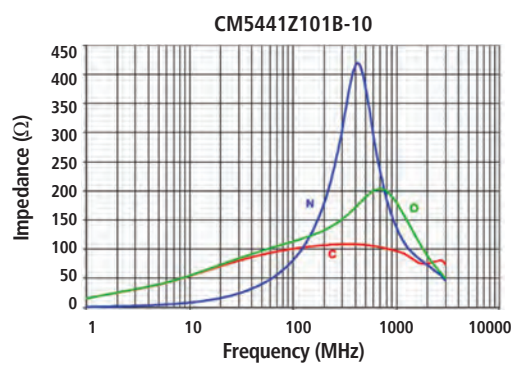
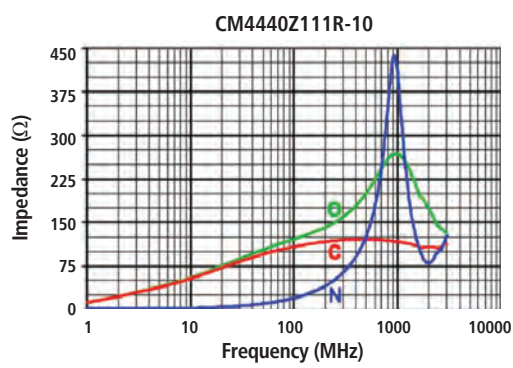
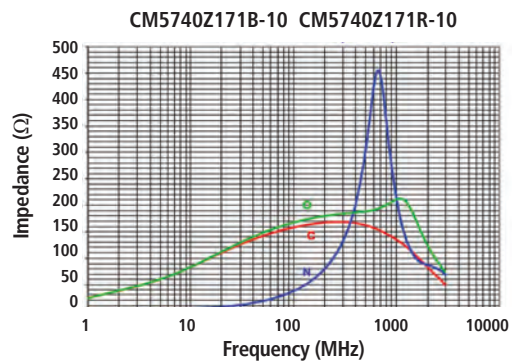
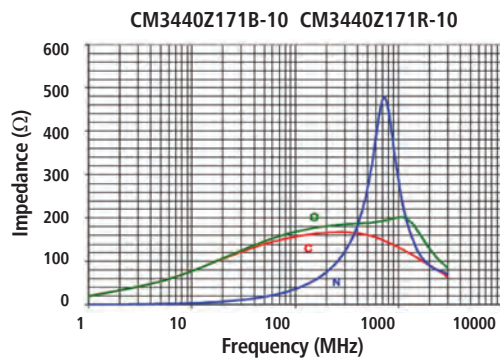
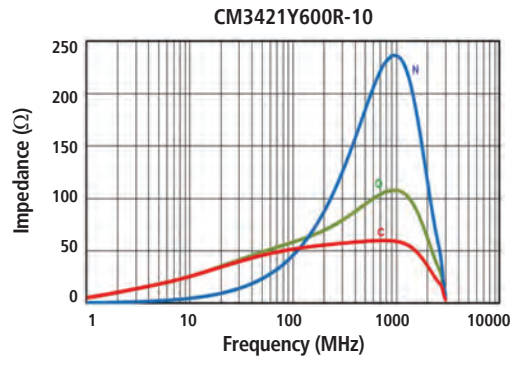
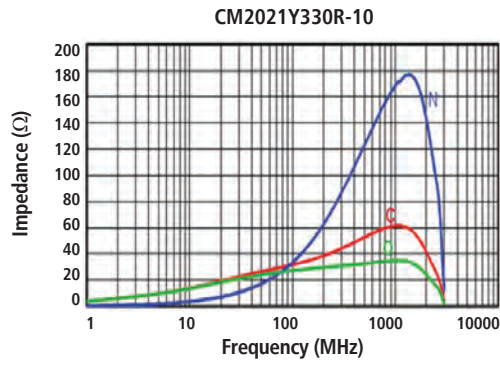

APPLICATION	TYPE	PART NUMBER	TYPICAL IMPEDANCE (Ω)				TYPICAL PEAK IMPEDANCE (Ω)	PEAK IMPEDANCE FREQUENCY (MHz)	DCR MAX (Ω)	RATED I MAX (CONTINUOUS) (mA)
			Z @ 25 MHz	Z @ 100 MHz	Z @ 500 MHz	Z @ 1 GHz				
Power Lines	Surface Mount (For 2 lines)	CM2021Y330R-10	18	33	52	61	62	1100	0.0008	15,000
		CM3421Y600R-10	39	60	96	110	110	1000	0.0008	15,000
	Thru-Hole (For 2 lines)	CM3440Z171B-10	116	170	189	202	202	1000	0.001	20,000
	Thru-Hole (For 4 lines)	CM5740Z171B-10	116	170	189	202	202	1000	0.001	20,000
	Surface Mount (For 2 lines)	CM3440Z171R-10	116	170	189	202	202	1000	0.001	20,000
	Surface Mount (For 4 lines)	CM5740Z171R-10	116	170	189	202	202	1000	0.001	20,000
	Surface Mount (For 3 lines)	CM4440Z111R-10	79	110	122	117	122	500	0.001	20,000
		CM4440Z121R-10	82	120	122	117	123	460	0.001	20,000
	Thru-Hole (For 2 lines)	CM5441Z101B-10	79	100	188	183	204	682	0.0003	30,000 mA @ 25°C Temp Rise 70,000 mA @ 30 °C Temp Rise
		CM5441Z161B-10	112	160	261	146	263	457	0.0003	
CM5441Z161R-10		110	160	260	140	265	460	0.0003		

COMMON MODE CHOKES

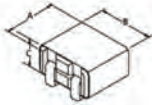
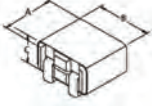
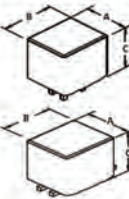

COMMON MODE CHOKES

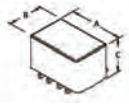
DIMENSION

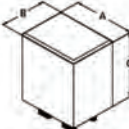
PART NUMBER	A mm (INCHES)	B mm (INCHES)	C mm (INCHES)	
CM2021Y330R-10	5.00 (0.197)	5.60 (0.220)	2.85 (0.112)	
CM3421Y600R-10	8.68 (0.342)	5.60 (0.220)	2.85 (0.112)	
CM3440Z171B-10	8.51 (0.335)	10.03 (0.395)	9.32 (0.367)	
CM3440Z171R-10	8.51 (0.335)	10.03 (0.395)	9.32 (0.367)	
CM5740Z171B-10	14.48 (0.570)	10.03 (0.395)	9.32 (0.367)	
CM5740Z171R-10	14.48 (0.570)	10.03 (0.395)	9.32 (0.367)	
CM4440Z111R-10	11.05 (0.435)	10.03 (0.395)	9.32 (0.367)	
CM5441Z101B-10	13.72 (0.540)	10.41 (0.410)	10.52 (0.414)	
CM5441Z161B-10	13.72 (0.540)	10.41 (0.410)	15.24 (0.600)	

LOW FREQUENCY
COMMON MODE CHOKES

APPLICATION	TYPE	PART NUMBER	TYPICAL IMPEDANCE (Ω)				TYPICAL PEAK IMPEDANCE (Ω)	PEAK IMPEDANCE FREQUENCY (MHz)	DCR MAX (Ω)	RATED I MAX (CONTINUOUS) (mA)
			Z @ 1 MHz	Z @ 4 MHz	Z @ 10 MHz	Z @ 100 MHz				
Signal/ Power Line	Surface Mount (For 2 lines)	CM1812C282R-10	370	1,100	1,900	2,800	3500	50	0.5	200
		CM2824B103R-10	10,000	8,900	3,980	400	13,200	2	1.3	400
		CM2824E182R-10	200	570	920	1,800	1,920	80	0.26	800
		CM2824E352R-10	350	1400	2,100	3,500	3,950	45	0.3	800
	Thru-Hole (For 4 lines)	CM2824E702R-10	3,000	7,000	5,800	800	7,200	6	0.26	700
		CM5740Z241B-10	170 (2 Turns)	240 (2 Turns)	173 (2 Turns)	100 (2 Turns)	276 (2 Turns)	3 (2 Turns)	0.0013	20,000

Impedance (Z) versus Frequency

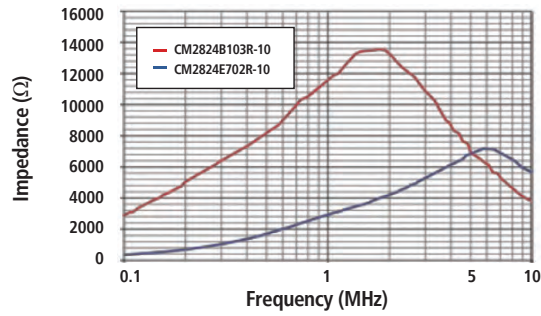
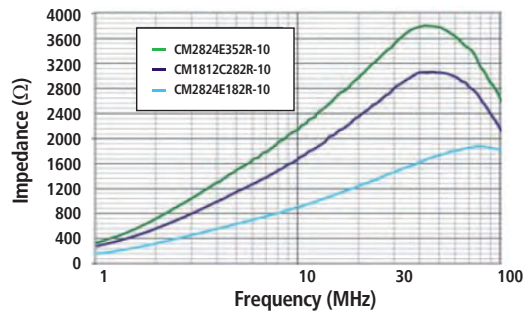

CM5740Z241B-10, 2 Turn Impedance (Z)

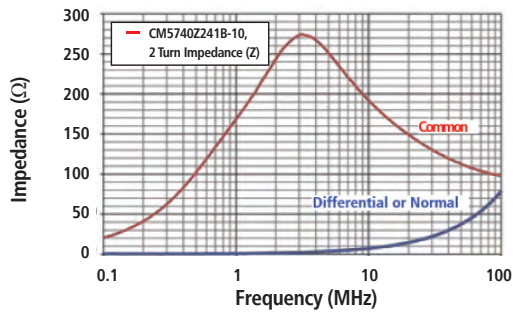

DIMENSION

PART NUMBER	A mm (INCHES)	B mm (INCHES)	C mm (INCHES)	
CM1812C282R-10	5.00 (0.197)	3.50 (0.138)	5.55 (0.140)	
CM2824B103R-10	7.50 (0.295)	5.50 (0.217)	3.80 (0.150)	
CM2824E182R-10	7.50 (0.295)	5.50 (0.217)	3.80 (0.150)	
CM2824E352R-10	7.50 (0.295)	5.50 (0.217)	3.80 (0.150)	
CM2824E702R-10	7.50 (0.295)	5.50 (0.217)	3.80 (0.150)	
CM5740Z241B-10	14.40 (0.570)	10.03 (0.395)	9.32 (0.387)	

COMMON MODE
ARRAYS

APPLICATION FOR POWER LINES

TYPE	PART NUMBER	TYPICAL IMPEDANCE (Ω)				TYPICAL PEAK IMPEDANCE (Ω)	PEAK IMPEDANCE FREQUENCY (MHz)	DCR MAX (Ω)	RATED I MAX (CONTINUOUS) (mA)
		Z @ 25 MHz	Z @ 100 MHz	Z @ 500 MHz	Z @ 1 GHz				
Surface Mount (For 4 lines)	CM2722R800R-10	60	80	92	98	140	3000	0.02	5,000
	CM2722R151R-10	113	150	165	165	168	1783	0.02	5,000
	CM2722R201R-10	141	200	202	187	206	272	0.02	5,000
Surface Mount (For 6 lines)	CM3822R800R-10	63	80	97	105	151	3000	0.02	5,000
	CM3822R151R-10	108	150	170	169	172	1646	0.02	5,000
	CM3822R201R-10	140	200	207	187	213	218	0.02	5,000
Surface Mount (For 8 lines)	CM5022R800R-10	61	80	95	102	150	3000	0.02	5,000
	CM5022R151R-10	112	150	165	167	177	2092	0.02	5,000
	CM5022R201R-10	144	200	206	188	210	306	0.02	5,000
Surface Mount (For 4 lines)	CM3032V121R-10	80	120	130	140	169	200	0.01	8,000
	CM3032V201R-10	143	200	210	199	214	319	0.01	8,000
	CM3032V301R-10	211	300	280	224	307	214	0.01	8,000
Surface Mount (For 6 lines)	CM4732V201R-10	152	200	218	187	229	241	0.01	8,000
	CM4732V301R-10	217	300	250	172	328	168	0.01	8,000
Surface Mount (For 8 lines)	CM6032V201R-10	140	200	219	213	219	500	0.01	8,000
	CM6032V301R-10	240	300	258	170	346	149	0.01	8,000
Thru-Hole (For 2 lines)	CM2545X171B-10	108	170	210	180	210	500	0.01	10,000
Surface Mount (For 2 lines)	CM2545X171R-10	108	170	210	180	210	500	0.01	10,000
Thru-Hole (For 4 lines)	CM4545Z131B-10	65	130	267	256	288	682	0.01	10,000
Surface Mount (For 4 lines)	CM4545Z131R-10	65	130	267	256	288	682	0.01	10,000

PART NUMBER	# OF CHOKES	TYPICAL IMPEDANCE (Ω) FOR MULTIPLE PASS BOARD LAYOUT OPTIONS											
		ONE PASS			TWO PASS			THREE PASS			FOUR PASS		
		100 MHz	500 MHz	1 GHz	100 MHz	500 MHz	1 GHz	100 MHz	500 MHz	1 GHz	100 MHz	500 MHz	1 GHz
CM2722R800R-10	2	80	92	98	174	190	173	-	-	-	-	-	-
CM2722R151R-10	2	150	165	165	292	311	222	-	-	-	-	-	-
CM2722R201R-10	2	200	202	187	433	362	187	-	-	-	-	-	-
CM3822R800R-10	3	80	97	105	174	190	173	304	334	257	-	-	-
CM3822R151R-10	3	150	170	169	292	311	222	490	448	226	-	-	-
CM3822R201R-10	3	200	207	187	433	362	187	670	470	208	-	-	-
CM5022R800R-10	4	80	95	102	174	190	173	304	334	257	389	446	283
CM5022R151R-10	4	150	165	167	292	311	222	490	448	226	674	535	229
CM5022R201R-10	4	200	206	188	433	362	187	670	470	208	945	499	212
CM3032V121R-10	2	120	130	140	266	284	241	-	-	-	-	-	-
CM3032V201R-10	2	200	210	199	432	300	175	-	-	-	-	-	-
CM3032V301R-10	2	300	280	224	631	251	156	-	-	-	-	-	-
CM4732V201R-10	3	200	218	187	491	317	182	771	331	194	-	-	-
CM4732V301R-10	3	300	250	172	684	258	156	967	278	172	-	-	-
CM6032V201R-10	4	200	219	213	472	313	179	737	315	193	995	358	250
CM6032V301R-10	4	300	258	170	681	266	161	926	273	167	1075	317	300

COMMON MODE
ARRAYS

Part Impedance

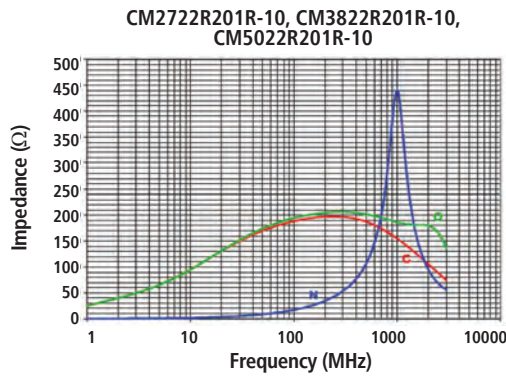
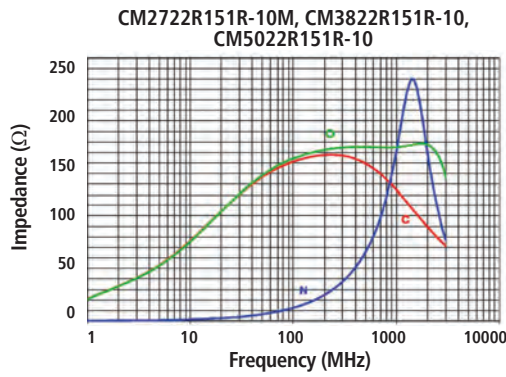
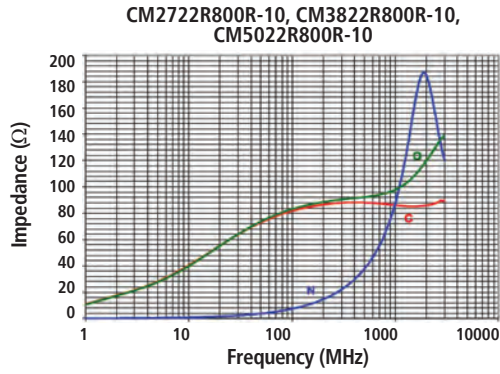

Multi-Pass Impedance
(for multiple pass board layout options)

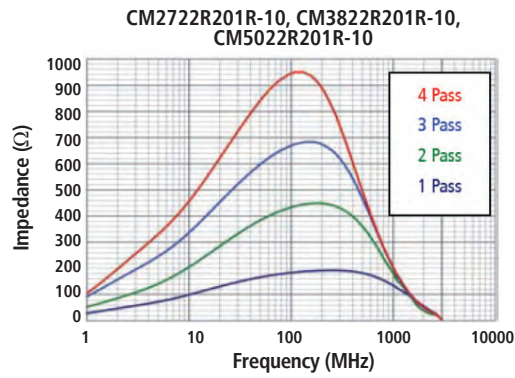
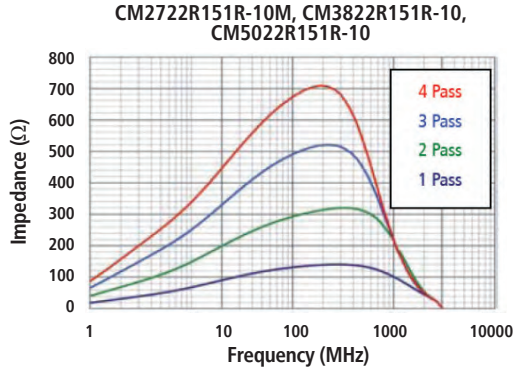
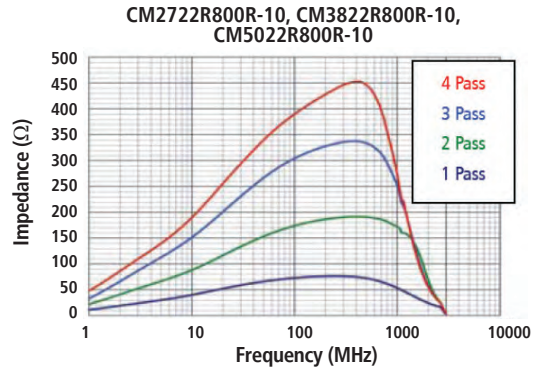

COMMON MODE
ARRAYS

Part Impedance

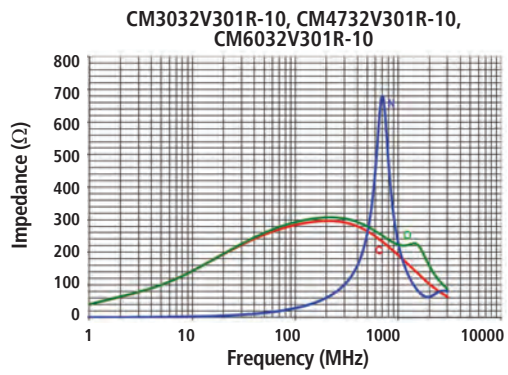
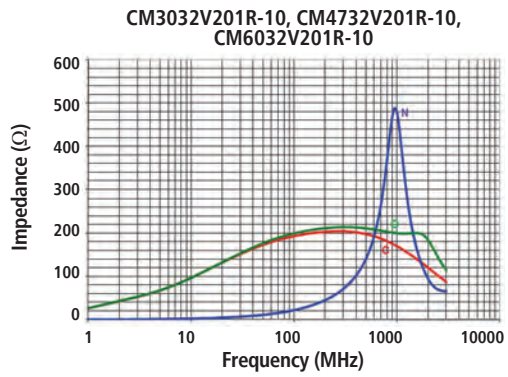
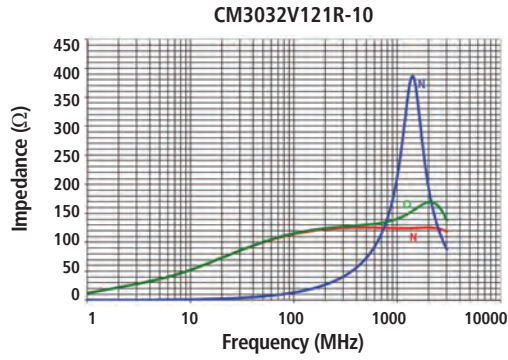

Multi-Pass Impedance
(for multiple pass board layout options)

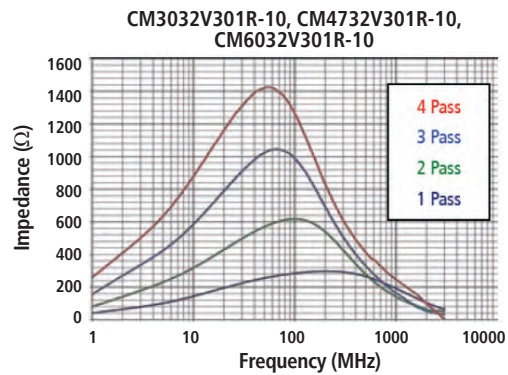
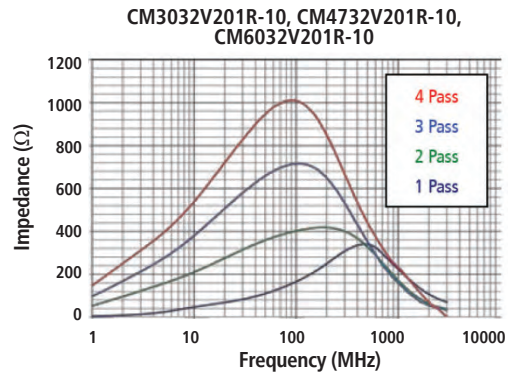
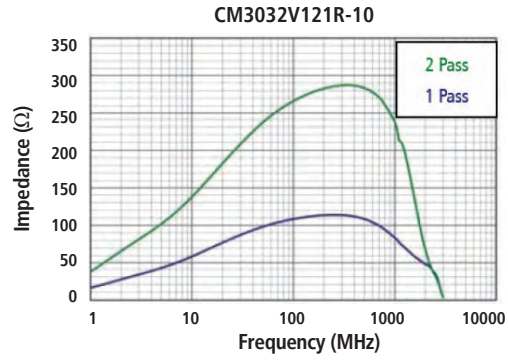

COMMON MODE
ARRAYS

CM2545X171B-10, CM2545X171R-10

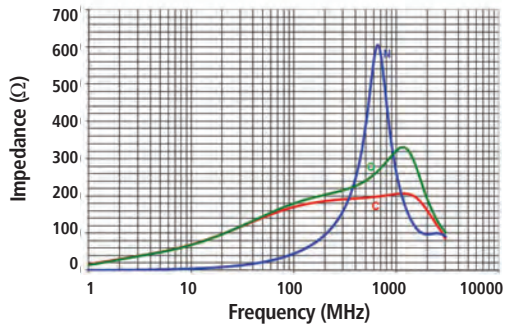

CM4545X131B-10, CM4545X131R-10

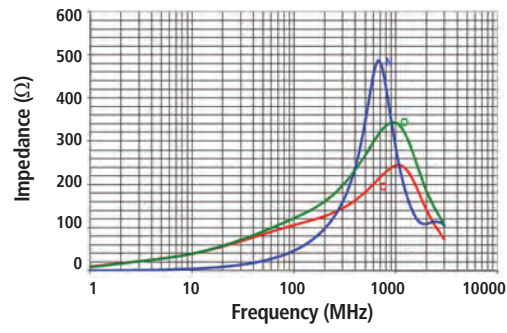



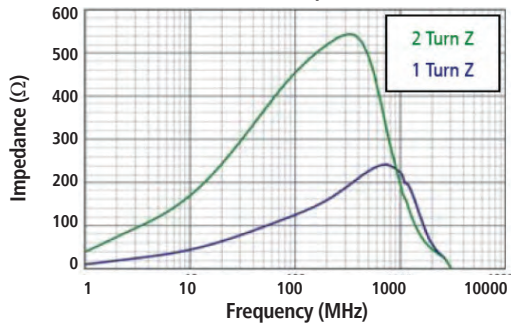



CM4545X131B-10, CM4545X131R-10,
Multi-Turn Impedance

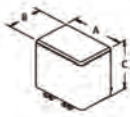
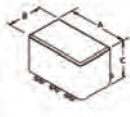
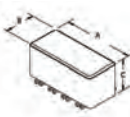

COMMON MODE
ARRAYS

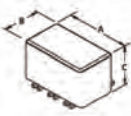
DIMENSION

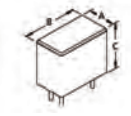
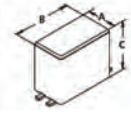
PART NUMBER	A mm (INCHES)	B mm (INCHES)	C mm (INCHES)	
CM2722R800R-10	6.99 (0.275)	5.72 (0.225)	4.32 (0.170)	
CM2722R151R-10	6.99 (0.275)	5.72 (0.225)	7.62 (0.300)	
CM2722R201R-10	6.99 (0.275)	5.72 (0.225)	9.53 (0.375)	
CM3822R800R-10	9.78 (0.385)	5.72 (0.225)	4.32 (0.170)	
CM3822R151R-10	9.78 (0.385)	5.72 (0.225)	7.62 (0.300)	
CM3822R201R-10	9.78 (0.385)	5.72 (0.225)	9.53 (0.375)	
CM5022R800R-10	12.57 (0.495)	5.72 (0.225)	4.32 (0.170)	
CM5022R151R-10	12.57 (0.495)	5.72 (0.225)	7.62 (0.300)	
CM5022R201R-10	12.57 (0.495)	5.72 (0.225)	9.53 (0.375)	
CM3032V121R-10	7.62 (0.300)	8.13 (0.320)	5.72 (0.225)	

PART NUMBER	A mm (INCHES)	B mm (INCHES)	C mm (INCHES)	
CM3032V201R-10	7.62 (0.300)	8.13 (0.320)	9.45 (0.372)	
CM3032V301R-10	7.62 (0.300)	8.13 (0.320)	14.48 (0.570)	
CM4732V201R-10	11.94 (0.470)	8.13 (0.320)	9.45 (0.372)	
CM4732V301R-10	11.94 (0.470)	8.13 (0.320)	14.48 (0.570)	
CM6032V201R-10	15.24 (0.600)	8.13 (0.320)	9.45 (0.372)	
CM6032V301R-10	15.24 (0.600)	8.13 (0.320)	14.48 (0.570)	
CM2545X171B-10	6.3 (0.248)	11.38 (0.448)	9.32 (0.367)	
CM2545X171R-10	6.3 (0.248)	11.38 (0.448)	9.32 (0.367)	
CM4545Z131B-10	11.38 (0.448)	11.38 (0.448)	9.32 (0.367)	
CM4545Z131R-11	11.38 (0.448)	11.38 (0.448)	9.32 (0.367)	

CAN-BUS COMMON MODE CHOKE
SERIES



FEATURES

- Accurate current matching capability over a broad range of inductance values
- Sector wound coils at 25 & 51 μ H to filter differential mode noise from the data signal.
- Low distortion
- Custom designs possible
- Open bottom case construction
- Small (1812) size parts are so available
- Surface Mount

HIGH SPEED SERIAL INTERFACE COMMON MODE CHOKE

TYPE	PART NUMBER	Lp IMPEDANCE (μ H)			PEAK IMPEDANCE (Ω)	L LEAKAGE (μ H)	HI-POT (VAC) 0.5 mA 2 SEC	DCR TYPICAL (Ω)	I _{dc} (mA)	
		TEST CONDITION	MIN	NOM						MAX
Surface Mount (For 2 lines)	CC1812C513R-10*	100 KHz / 50mV	35.7	51	66.3	3500 @40 MHz	2.6	250	0.5	200
	CC2824J502R-10	100 KHz / 50 mV	3.5	5	6.5	400 @ 500 MHz	0.05	250	0.1	1200
	CC2824E113R-10	100 KHz / 50mV	7.7	11	14.3	800 @ 200 MHz	0.05	250	0.12	800
	CC2824E253R-10	100 KHz / 50mV	17.5	25	32.5	2000 @ 100 MHz	1.5	250	0.13	800
	CC2824E513R-10*	100 KHz / 50mV	35	51	66.3	3800 @ 50 MHz	2	250	0.16	800
	CC2824E474R-10	100 KHz / 50mV	329	470	611	8600 @ 5 MHz	0.2	750	0.2	700
	CC2824E105R-10	100 KHz / 50mV	700	1000	1500	4250 @ 7 MHz	0.2	750	0.2	700
	CC2824D225R-10	10 KHz / 50mV	1540	2200	3300	5300 @ 5 MHz	0.25	750	0.4	500
	CC2824B475R-10	10 KHz / 50mV	3290	4700	7050	12300 @ 2 MHz	0.3	750	0.55	400

* Sector Wound

DIMENSION

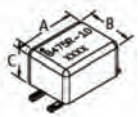
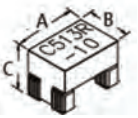
PART NUMBER	A mm (INCHES)	B mm (INCHES)	C mm (INCHES)	
CC2824	7.50 MAX (0.295 MAX)	5.50 MAX (0.217 MAX)	3.80 MAX (0.150 MAX)	
CC1812	5.00 MAX (0.197 MAX)	3.50 MAX (0.138 MAX)	5.55 MAX (0.140 MAX)	

CAN-BUS COMMON MODE CHOKE
SERIES

Typical Insertion Loss @ 50 Ω

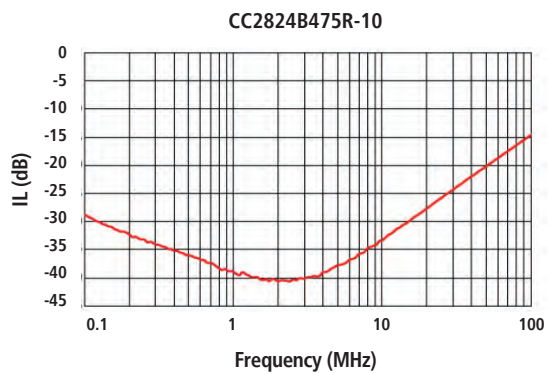
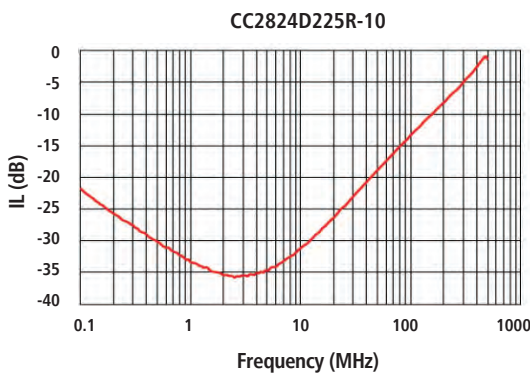
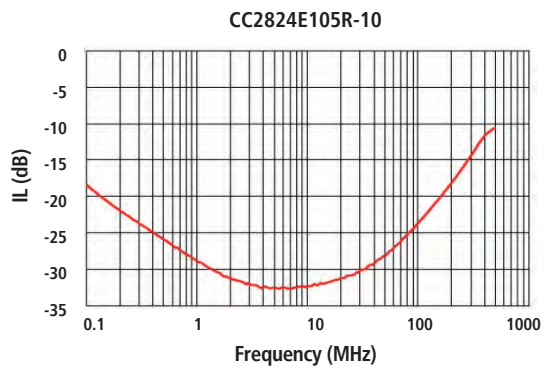
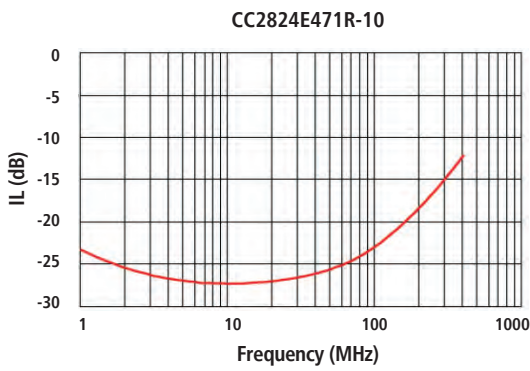
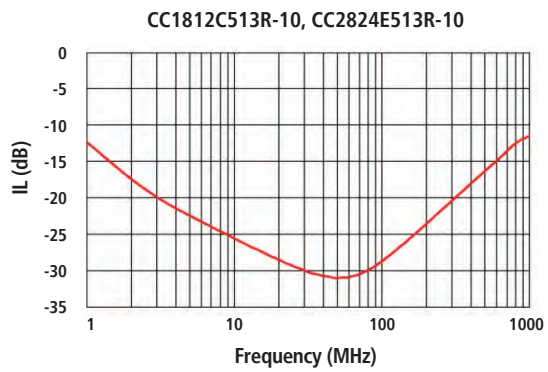
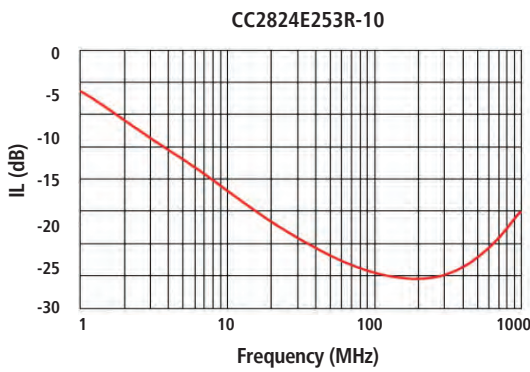
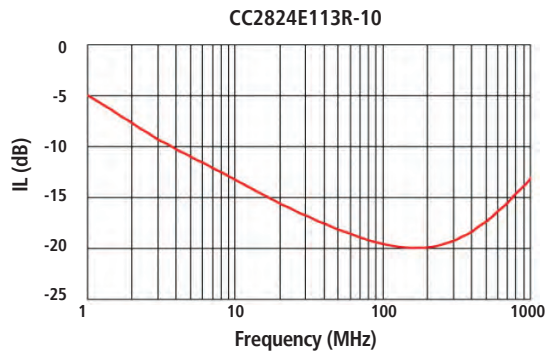
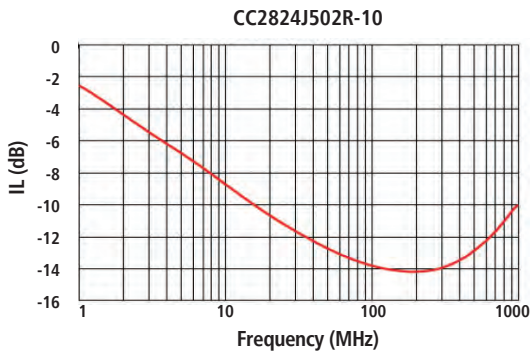

PASSES AND TURNS

EMI Chip Beads, Chip Inductors



CM Beads, CM 05 / 21 / 40 / 41
/ 45, LF CM, Can Bus

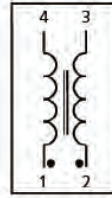

CM5740Z241B-10, CM 45 Array

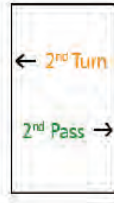
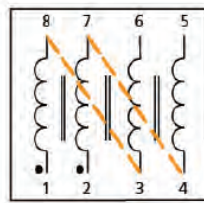
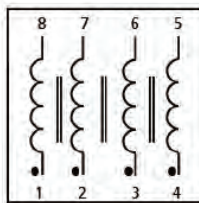

CM22 Array, CM 32 Array, CM 40 Array

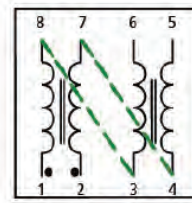
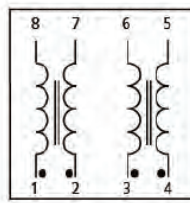

CM22 Array, CM 32 Array

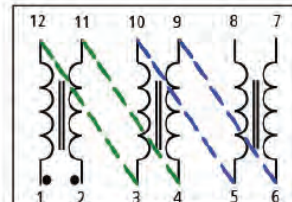
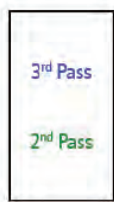
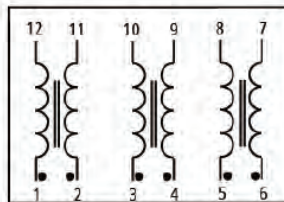

CM22 Array, CM 32 Array

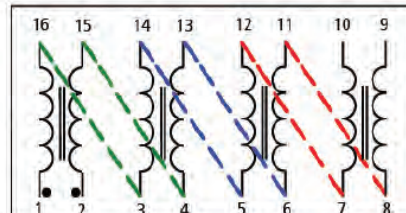
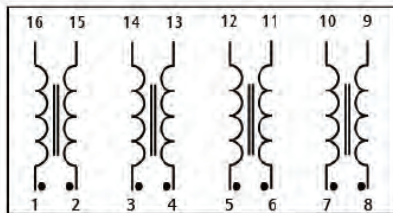

EXPLANATION OF PASSES & TURNS

Laird multi-choke arrays can be electrically connected in the PC board to increase effective impedance. When the PCB circuits are configured, as shown above, such that individual side-by-side chokes within one array part are connected in series, the impedance is increased by a factor of the number of passes through the part. Since internal construction of Laird ferrite common mode chokes varies, Laird refers to this special installation configuration using the different terms of "pass" (additive) or "turn" (multiplicative).

When the term "pass" is used to describe series connections through a choke, each additional pass increases the impedance (Z) in proportion to the number of series PCB connections applied. Each additional "pass" adds a choke in series. If needed, it's an optional effective method of increasing impedance with an array.

When the term "turn" is used to describe series connection through a choke, each additional turn increases the impedance in proportion to the square of the number of series PCB connections applied. Each turn multiplies impedance.

Parts have no polarity.

WIRE-WOUND SMT POWER COMMON-MODE
CHOKES



CMX 1211 Series

FEATURES



- Small size with high current
- Stable performance under load bias and high reliability
- High suppression of asymmetric interferences at both low and high frequency
- SMT Type with less height
- Operation temperature: -40°C to 125°C (Including self-heating)
- Custom designs on request

APPLICATIONS

- Interferences suppression of common mode noise
- Power line filter
- Switch-mode power supplies

ELECTRICAL SPECIFICATIONS

PART NO.	INDUCTANCE @ 100 KHZ / 100 mV (uH)			DCR MAX (mΩ)	CURRENT RATING MAX (A)	RATING VOLTAGE MAX (Vrms)	HIPOT COIL – COIL (VAC)
	NOM	MIN	MAX				
CMX1211Z680B-10	68	40.8	91.8	0.56	50	250	1500
CMX1211Z181B-10	180	108	243	1.35	32	250	1500
CMX1211Z321B-10	320	192	432	2.5	28	250	1500
CMX1211Z601B-10	620	372	837	3.5	20	250	1500
CMX1211Y801B-10	800	480	1080	5.3	16	250	1500
CMX1211X132B-10	1300	780	1755	10	11	250	1500
CMX1211W182B-10	1800	1080	2430	14	9	250	1500

DIMENSIONS CMX1211

Unit: mm



A Max	B Max	C Max
31.50	19.00	28.80

ORDERING INFORMATION

CMX1211 SERIES PART NUMBER EXAMPLE C M X 1 2 1 1 Z 6 8 0 B - 1 0

Product series code EIA size code (L x W) Rated Current Code Inductance value code (L) Packing Code Additional Description

X = 10,000 mA Y = 15,000 mA Z = 20,000 mA 401 = 396 uH 171 = 176 uH 222 = 2156 uH B = Bulk Packaging

TYPICAL CHARACTERISTICS – ZRX VS FREQUENCY

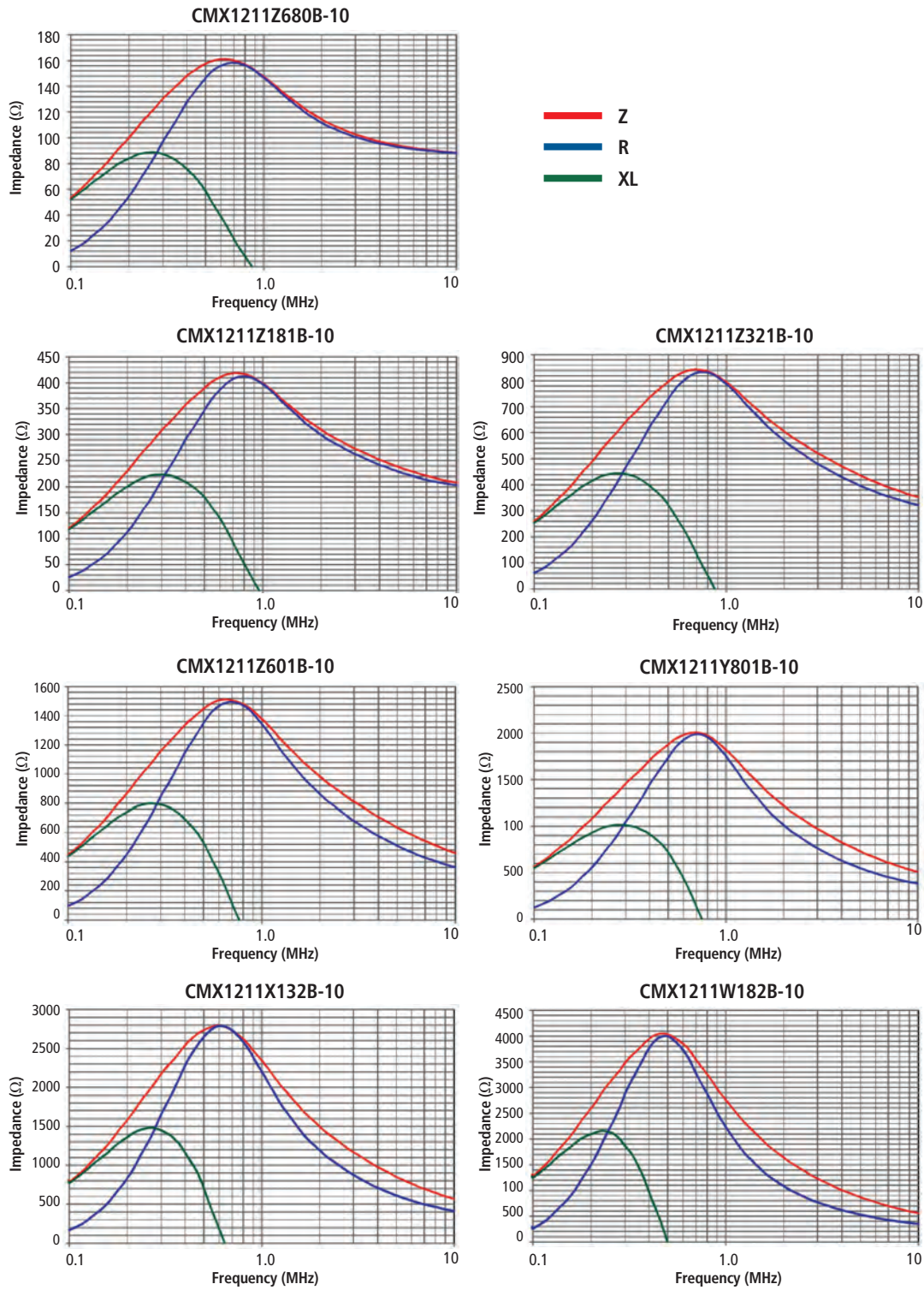

WIRE-WOUND DIP POWER COMMON-MODE
CHOKES



CMX 1616 Series

FEATURES



- Current rating up to 62 Amp
- Stable performance and high reliability
- High suppression of asymmetric interferences at both low and high frequency
- Operation temperature: -40°C to 125°C (Including self-heating)
- Custom designs on request

APPLICATIONS

- Interferences suppression of common mode noise
- Power line filter
- Switch-mode power supplies

ELECTRICAL SPECIFICATIONS

PART NO.	INDUCTANCE @ 100 KHZ / 100 mV (uH)			DCR MAX (mΩ)	CURRENT RATING MAX (A)	RATING VOLTAGE MAX (Vrms)	HIPOT COIL – COIL (VAC)
	NOM	MIN	MAX				
CMX1616X282B-10	2816	1689	3802	11.0	14	250	1500
CMX1616Y222B-10	2156	1293	2911	6.0	19	250	1500
CMX1616Z112B-10	1000	600	1350	2.8	30	250	1500
CMX1616Z162B-10	1584	950	2138	4.1	24	250	1500
CMX1616Z171B-10	176	105	238	0.65	62	250	1500
CMX1616Z401B-10	396	237	535	1.15	46	250	1500
CMX1616Z701B-10	704	422	951	2.3	33	250	1500

ORDERING INFORMATION

CMX1616 SERIES PART NUMBER EXAMPLE

C M X	1 6 1 6	Z	1 1 2	B	- 1 0
Product series code	EIA size code (L x W)	Rated Current Code X = 10,000 mA Y = 15,000 mA Z ≥ 20,000 mA	Inductance value code (L) 401 = 396 uH 171 = 176 uH 222 = 2156 uH	Packing Code B = Bulk Packaging	Additional Description

CMX1616 SERIES

WIRE-WOUND DIP POWER COMMON-MODE CHOKES

DIMENSIONS Unit: mm

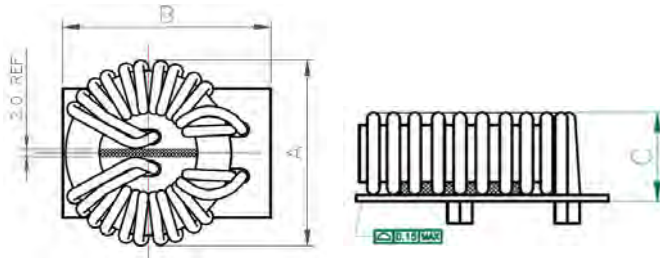

Part Number	A Max	B Max	C Max	LAND PATTERN
CMX1616X282B-10	42.00	40.00	15.50	
CMX1616Y222B-10	42.00	40.00	15.50	
CMX1616Z112B-10	40.00	40.00	16.50	
CMX1616Z162B-10	42.00	41.00	16.50	
CMX1616Z171B-10	41.00	41.00	16.50	
CMX1616Z401B-10	41.00	41.00	16.50	
CMX1616Z701B-10	40.00	40.00	16.50	

TYPICAL CHARACTERISTICS – ZRX VS FREQUENCY

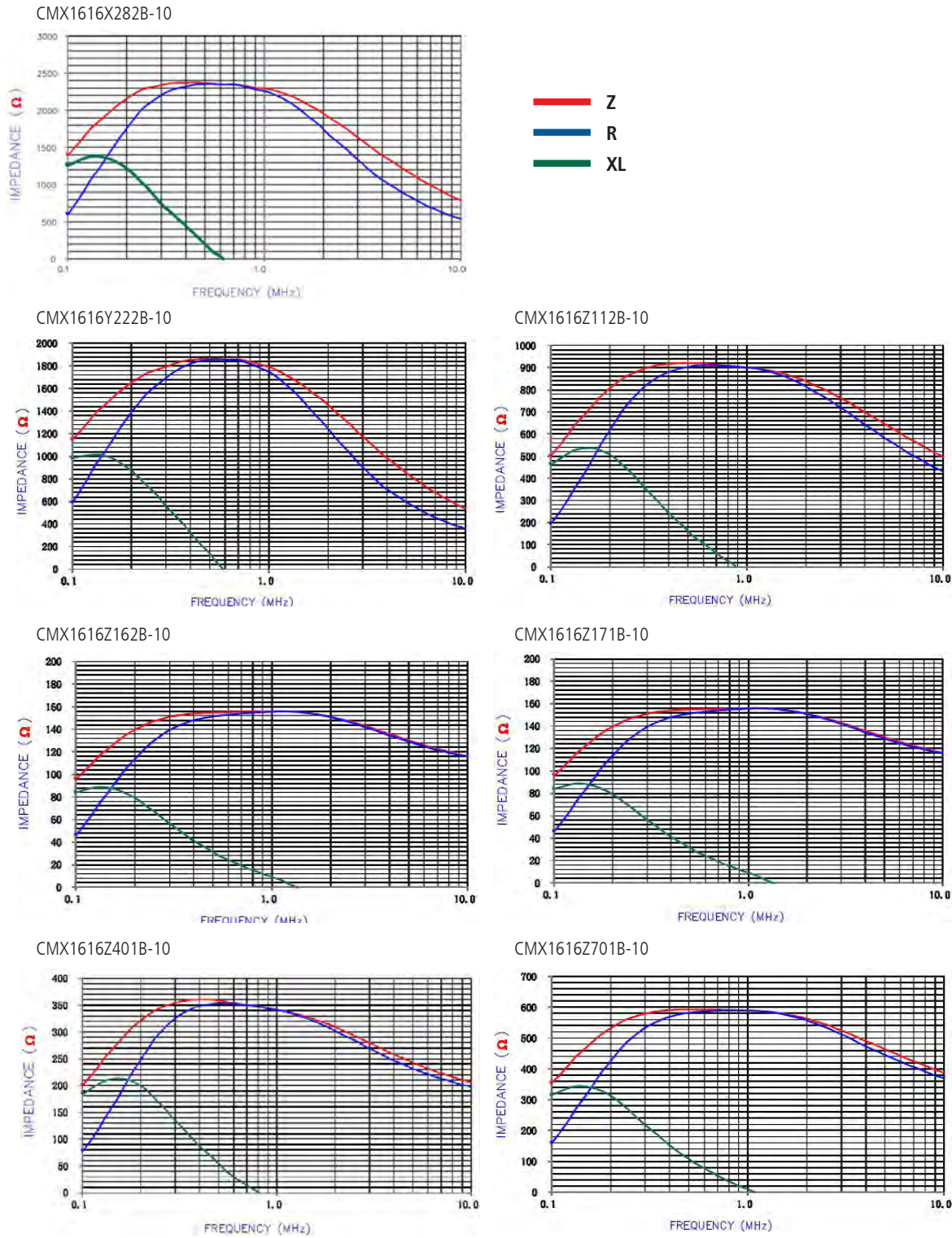

COMMON MODE CHOKE
SERIES

SORTED BY IMPEDANCE @ 100 MHz OR 4 MHz

PART NUMBER	TYPICAL Z Ω @ 25 MHz	NOMINAL Z Ω @ 100 MHz	TYPICAL Z Ω @ 500 MHz	TYPICAL Z Ω @ 1 GHz	TYPICAL PEAK IMPEDANCE (Ω)	TYPICAL PEAK IMPEDANCE FREQ. (MHz)	DCR MAX (Ω)	RATED CONTINUOUS CURRENT (mA)	A (mm) LENGTH	B (mm) WIDTH	C (mm) HEIGHT
CM2021Y330R-10	18	33	52	61	62	1100	0.001	15,000	5.60	2.85	5.00
CM3421Y600R-10	39	60	96	110	110	1000	0.001	15,000	5.60	2.85	8.68
CF0805D670R-10	24	67	196	98	166	510	0.4	400	2.00	1.25	1.00
CM2722R800R-10	60	80	92	98	140	3000	0.02	5,000	6.99	5.72	4.32
CM3822R800R-10	64	80	97	105	151	3000	0.02	5,000	9.78	5.72	4.32
CM5022R800R-10	61	80	95	102	150	3000	0.02	5,000	12.57	5.72	4.32
CF0504C900R-10	28	90	210	148	217	583	0.6	300	1.25	1.00	0.82
CF0805D900R-10	32	90	210	106	220	435	0.4	400	2.00	1.25	1.00
CM0805D900R-10	24	90	340	435	445	1405	0.3	400	2.00	1.20	1.20
CH0805D900R-10	48	90	249	339	494	2000	0.3	400	2.00	1.20	1.20
CM5441Z101B-10	79	100	188	183	204	682	0.0008	75,000	13.72	10.41	10.52
CM4440Z111R-10	79	110	122	177	122	500	0.001	20,000	11.05	10.03	9.32
CM4440Z121R-10	82	120	122	117	123	460	0.001	20,000	11.05	10.03	9.32
CF0504C121R-10	33	120	250	145	250	500	0.6	300	1.25	1.00	0.82
CF0805D121R-10	36	120	240	103	260	397	0.4	400	2.00	1.25	1.00
CM3032V121R-10	80	120	130	140	169	2010	0.01	8,000	7.62	8.13	5.72
CM4545Z131B-10	65	130	267	256	288	682	0.01	10,000	11.38	11.38	9.32
CM4545Z131R-10	65	130	267	256	288	682	0.01	10,000	11.38	11.38	9.32
CM5022R151R-10	113	150	165	167	177	2092	0.02	5,000	12.57	5.72	7.62
CM2722R151R-10	113	150	165	165	168	1783	0.02	5,000	6.99	5.72	7.62
CM3822R151R-10	107	150	170	169	172	1646	0.02	5,000	9.78	5.72	7.62
CM0805C161R-10	49	160	540	684	684	1000	0.35	300	2.00	1.20	1.20
CM1206C161R-10	81	160	358	555	718	2177	0.4	340	3.20	1.60	1.80
CM5441Z161B-10	112	160	261	146	263	457	0.0008	75,000	13.72	10.41	15.24
CM5441Z161R-10	110	160	260	140	265	457	0.0003	75,000	13.72	10.41	15.24
CM3440Z171B-10	116	170	189	202	202	1000	0.001	20,000	8.51	10.03	9.32
CM3440Z171R-10	116	170	189	202	202	1000	0.001	20,000	8.51	10.03	9.32
CM5740Z171B-10	114	170	189	202	202	1000	0.001	20,000	14.48	10.03	9.32
CM5740Z171R-10	114	170	189	202	202	1000	0.001	20,000	14.48	10.03	9.32
CM2545X171B-10	108	170	210	180	210	500	0.01	10,000	6.30	11.38	9.32
CM2545X171R-10	108	170	210	180	210	500	0.01	10,000	6.30	11.38	9.32
CF0805D181R-10	48	180	123	42	277	210	0.5	400	2.00	1.25	1.00
CM6032V201R-10	140	200	219	213	219	500	0.01	8,000	15.24	8.13	9.45
CM3032V201R-10	143	200	210	199	214	319	0.01	8,000	7.62	8.13	9.45
CM5022R201R-10	142	200	206	188	210	306	0.02	5,000	12.57	5.72	9.53
CM2722R201R-10	142	200	202	187	206	272	0.02	5,000	6.99	5.72	9.53
CM4732V201R-10	152	200	218	187	229	241	0.01	8,000	11.94	8.13	9.45
CM3822R201R-10	141	200	207	187	213	218	0.02	5,000	9.78	5.72	9.53
CF0805C221R-10	50	220	109	33	296	180	0.5	300	2.00	1.25	1.00
CM0805C221R-10	57	220	570	720	724	1147	0.4	300	2.00	1.20	1.20
CM3032V301R-10	211	300	280	224	307	214	0.01	8,000	7.62	8.13	14.48
CM4732V301R-10	217	300	250	172	328	168	0.01	8,000	11.94	8.13	14.48
CM6032V301R-10	240	300	258	170	346	149	0.01	8,000	15.24	8.13	14.48
CM0805A371R-10	186	370	730	878	878	1000	0.5	100	2.00	1.20	1.20
Low Frequency Parts	@ 1 MHz	@ 4 MHz	@ 10 MHz	@ 25 MHz	(Ohms)	(MHz)	(Ohms)	(mA)	(mm)	(mm)	(mm)
CM5740Z241B-10	170 (2 Turns)	240 (2 Turns)	173 (2 Turns)	140 (2 Turns)	276 (2 Turns)	3 (2 Turns)	0.001	20,000	14.48	10.03	9.32
CM2824E182R-10	200	570	920	1400	1920	80	0.26	800	7.50	5.50	3.80
CM1812C282R-10	370	1100	1900	2700	3500	50	0.5	200	5.00	3.50	5.55
CM2824E352R-10	350	1400	2100	3200	3950	45	0.3	800	7.50	5.50	3.80
CM2824E702R-10	3000	7000	5800	4800	7200	6	0.26	700	7.50	5.50	3.80
CM2824B103R-10	10000	8900	3980	1800	13200	2	1.3	400	7.50	5.50	3.80

COMMON MODE CHOKE
SERIES

SORTED BY RATED CURRENT (AT CONTINUOUS OPERATION)

PART NUMBER	TYPICAL Z Ω @ 25 MHz	NOMINAL Z Ω @ 100 MHz	TYPICAL Z Ω @ 500 MHz	TYPICAL Z Ω @ 1 GHz	TYPICAL PEAK IMPEDANCE (Ω)	TYPICAL PEAK IMPEDANCE FREQ. (MHz)	DCR MAX (Ω)	RATED CONTINUOUS CURRENT (mA)	A (mm) LENGTH	B (mm) WIDTH	C (mm) HEIGHT
CM0805A371R-10	186	370	730	878	878	1,000	0.5	100	2.00	1.20	1.20
CM0805C161R-10	49	160	540	684	684	1,000	0.35	300	2.00	1.20	1.20
CM0805C221R-10	57	220	570	720	724	1,147	0.4	300	2.00	1.20	1.20
CF0504C900R-10	28	90	210	148	217	583	0.6	300	1.25	1.00	0.82
CF0504C121R-10	33	120	250	145	250	500	0.6	300	1.25	1.00	0.82
CF0805C221R-10	50	220	109	33	296	180	0.5	300	2.00	1.25	1.00
CF0805D670R-10	24	67	196	98	166	510	0.4	400	2.00	1.25	1.00
CF0805D900R-10	32	90	210	106	220	435	0.4	400	2.00	1.25	1.00
CF0805D121R-10	36	120	240	103	260	397	0.4	400	2.00	1.25	1.00
CF0805D181R-10	48	180	123	42	277	210	0.5	400	2.00	1.25	1.00
CH0805D900R-10	48	90	249	339	494	2000	0.3	400	2.00	1.20	1.20
CM0805D900R-10	24	90	340	435	445	1,405	0.3	400	2.00	1.20	1.20
CM2722R151R-10	113	150	165	165	168	1,783	0.02	5,000	6.99	5.72	7.62
CM2722R201R-10	142	200	202	187	206	272	0.02	5,000	6.99	5.72	9.53
CM2722R800R-10	60	80	92	98	140	3,000	0.02	5,000	6.99	5.72	4.32
CM3822R151R-10	107	150	170	169	172	1,646	0.02	5,000	9.78	5.72	7.62
CM3822R201R-10	141	200	207	187	213	218	0.02	5,000	9.78	5.72	9.53
CM3822R800R-10	64	80	97	105	151	3,000	0.02	5,000	9.78	5.72	4.32
CM5022R151R-10	113	150	165	167	177	2,092	0.02	5,000	12.57	5.72	7.62
CM5022R201R-10	142	200	206	188	210	306	0.02	5,000	12.57	5.72	9.53
CM5022R800R-10	61	80	95	102	150	3,000	0.02	5,000	12.57	5.72	4.32
CM3032V121R-10	80	120	130	140	169	2,010	0.01	8,000	7.62	8.13	5.72
CM3032V201R-10	143	200	210	199	214	319	0.01	8,000	7.62	8.13	9.45
CM3032V301R-10	211	300	280	224	307	214	0.01	8,000	7.62	8.13	14.48
CM4732V201R-10	152	200	218	187	229	241	0.01	8,000	11.94	8.13	9.45
CM4732V301R-10	217	300	250	172	328	168	0.01	8,000	11.94	8.13	14.48
CM6032V201R-10	140	200	219	213	219	500	0.01	8,000	15.24	8.13	9.45
CM6032V301R-10	240	300	258	170	346	149	0.01	8,000	15.24	8.13	14.48
CM2545X171B-10	108	170	210	180	210	500	0.01	10,000	6.30	11.38	9.32
CM2545X171R-10	108	170	210	180	210	500	0.01	10,000	6.30	11.38	9.32
CM45452131B-10	65	130	267	256	288	682	0.01	10,000	11.38	11.38	9.32
CM45452131R-10	65	130	267	256	288	682	0.01	10,000	11.38	11.38	9.32
CM2021Y330R-10	18	33	52	61	62	1,100	0.001	15,000	5.60	2.85	5.00
CM3421Y600R-10	39	60	96	110	110	1,000	0.001	15,000	5.60	2.85	8.68
CM3440Z171B-10	116	170	189	202	202	1,000	0.001	20,000	8.51	10.03	9.32
CM3440Z171R-10	116	170	189	202	202	1,000	0.001	20,000	8.51	10.03	9.32
CM4440Z111R-10	79	110	122	117	122	500	0.001	20,000	11.05	10.03	9.32
CM5740Z171B-10	114	170	189	202	202	1,000	0.001	20,000	14.48	10.03	9.32
CM5740Z171R-10	114	170	189	202	202	1,000	0.001	20,000	14.48	10.03	9.32
CM5441Z101B-10	79	100	188	183	204	682	0.0008	75,000	13.72	10.41	10.52
CM5441Z101B-13	79	100	188	183	204	682	0.0008	75,000	13.72	10.41	10.52
CM5441Z161B-10	112	160	261	146	263	457	0.0008	75,000	13.72	10.41	15.24
CM5441Z161B-13	112	160	261	146	263	457	0.0008	75,000	13.72	10.41	15.24
Low Frequency Parts	@ 1 MHz	@ 4 MHz	@ 10 MHz	@ 25 MHz	(Ohms)	(MHz)	(Ohms)	(mA)	(mm)	(mm)	(mm)
CM1812C282R-10	370	1,100	1,900	2,700	3,500	50	0.5	200	5.00	3.50	5.55
CM2824B103R-10	10,000	8,900	3,980	1,800	13,200	2	1.3	400	7.50	5.50	3.80
CM2824E702R-10	3,000	7,000	5,800	4,800	7,200	6	0.26	700	7.50	5.50	3.80
CM2824E182R-10	200	570	920	1,400	1,920	80	0.26	800	7.50	5.50	3.80
CM2824E352R-10	350	1,400	2,100	3,200	3,950	45	0.3	800	7.50	5.50	3.80
CM5740Z241B-10	170 (2 Turns)	240 (2 Turns)	173 (2 Turns)	140 (2 Turns)	276 (2 Turns)	3 (2 Turns)	0.001	20,000	14.48	10.03	9.32

DIFFERENTIAL MODE EMI FILTERS



FEATURES

- Differential mode EMI filter, high current, thru-hole type
- Up to 5 Amps continuous operation current
- Low DCR
- For power lines application for LCD-TV, automotive, telecom, test equipment etc.

PART NUMBERING SYSTEM

28	L	0138	-1	0	R	-10
Material Code	Product Code	EIA Size Code	Stated Dimension Code	Additional Description	Packing Code	Additional Description

TYPE	PART NUMBER	TYPICAL IMPEDANCE (Ω)				TYPICAL PEAK IMPEDANCE (Ω)	PEAK IMPEDANCE FREQUENCY (MHZ)	DCR MAX (Ω)	RATED I MAX (CONTINUOUS) mA
		Z @ 25 MHz	Z @ 100 MHz	Z @ 500 MHz	Z @ 1 GHz				
Power Line Thru-Hole (Single Turn)	28L0138-10R-10	45	75	70	55	80	200	0.01	5,000
	28L0138-40R-10	99	135	180	80	138	200	0.01	5,000
	28L0138-50R-10	92	153	152	111	161	150	0.01	5,000
	28L0138-70R-10	123	220	180	110	220	100	0.01	5,000
	28L0138-80R-10	48	86	78	57	85	100	0.01	5,000
Power Line Thru-Hole (Multiple Turns)	28C0236-0BS-10	500	835	480	220	846	156	0.01	5,000
	28C0236-0BW-10	500	835	480	220	846	156	0.01	5,000
	28C0236-0DW-10	260	460	478	360	498	300	0.01	5,000
	28C0236-0EW-10	620	998	484	205	1010	140	0.01	5,000
	28C0236-0JW-10	620	998	484	205	1010	140	0.01	5,000

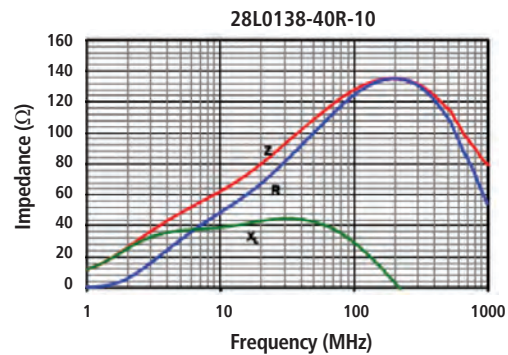
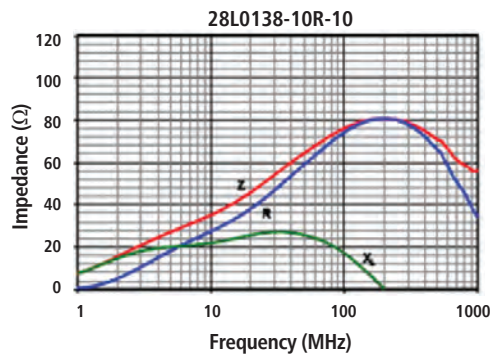

DIFFERENTIAL MODE EMI
FILTERS

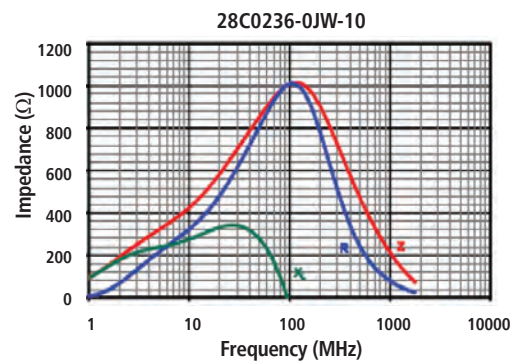
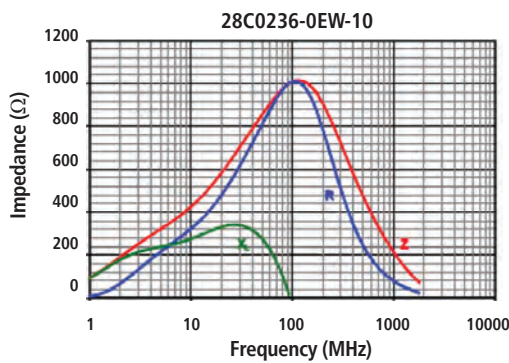
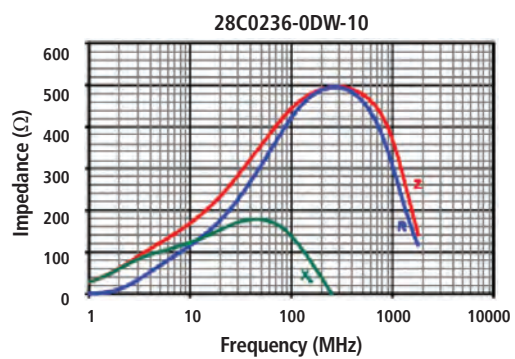
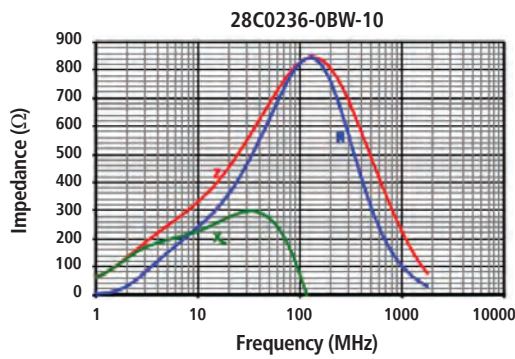
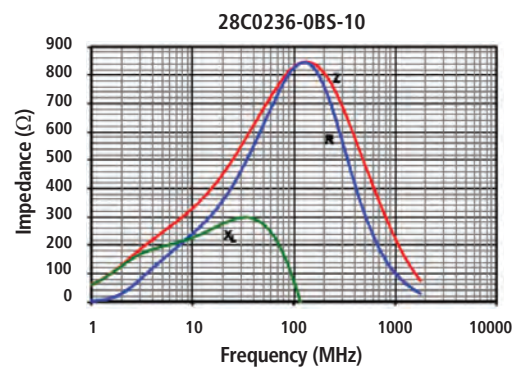
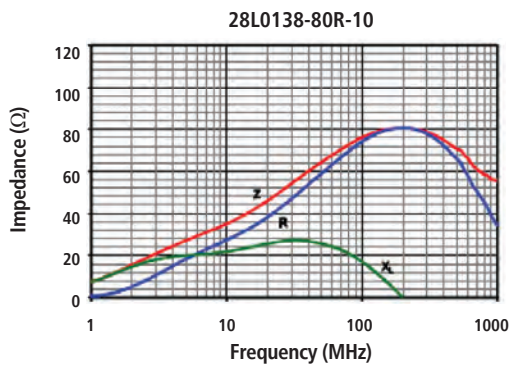
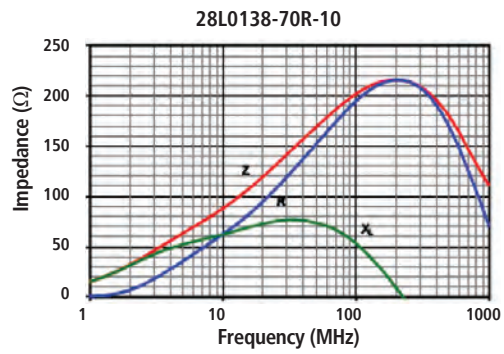
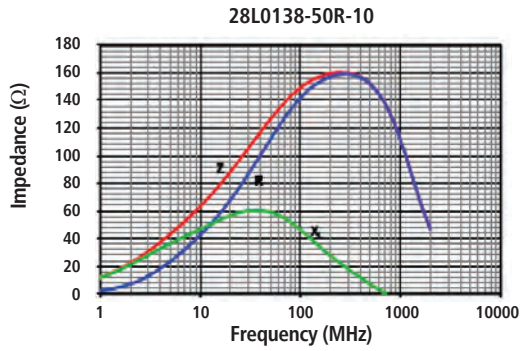

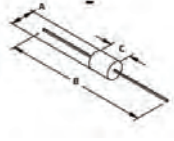

DIFFERENTIAL MODE EMI
FILTERS

DIMENSION

PART NUMBER	A mm (INCHES)	B mm (INCHES)	C mm (INCHES)	
28L0138-10R-10	3.51 (0.138)	59.00 (2.323)	4.45 (0.175)	
28L0138-40R-10	3.51 (0.138)	59.00 (2.323)	8.89 (0.350)	
28L0138-50R-10	3.51 (0.138)	59.00 (2.323)	9.53 (0.375)	
28L0138-70R-10	3.51 (0.138)	59.00 (2.323)	13.97 (0.550)	
28L0138-80R-10	3.51 (0.138)	59.00 (2.323)	5.23 (0.206)	

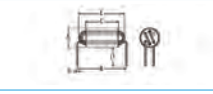
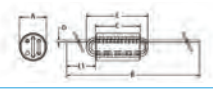
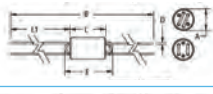
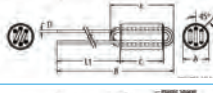
DIMENSION

PART NUMBER	A mm (INCHES)	B mm (INCHES)	C mm (INCHES)	D mm (INCHES)	E mm (INCHES)	F mm (INCHES)	L1 mm (INCHES)	
28C0236-0BS-10	6.00 (0.236)	14.99 (0.590)	10.00 (0.394)	0.51 (0.020)	14.61 (0.575)	-	5.99 (0.236)	
28C0236-0BW-10	6.00 (0.236)	86.46 (3.404)	10.00 (0.394)	0.51 (0.020)	14.61 (0.575)	-	38.10 (1.500)	
28C0236-0DW-10	6.00 (0.236)	86.46 (3.404)	10.00 (0.394)	0.51 (0.020)	14.61 (0.575)	-	38.23 (1.505)	
28C0236-0EW-10	6.00 (0.236)	50.53 (1.989)	10.00 (0.394)	0.51 (0.020)	14.61 (0.575)	-	38.10 (1.500)	
28C0236-0JW-10	6.00 (0.236)	20.96 (0.825)	10.00 (0.394)	0.51 (0.020)	15.90 (0.626)	5.08 (0.200)	5.08 (0.200)	

EMI FILTER ARRAYS

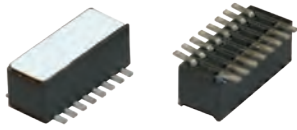

POWER LINE

TYPE	PART NUMBER	TYPICAL IMPEDANCE (Ω)				TYPICAL PEAK IMPEDANCE (Ω)	PEAK IMPEDANCE FREQUENCY (MHz)	DCR MAX (Ω)	RATED I MAX (CONTINUOUS) mA
		Z @ 25 MHz	Z @ 100 MHz	Z @ 500 MHz	Z @ 1 GHz				
Thru-Hole (3 lines)	29F0303-0T0-10	180	266	278	215	288	200	0.01	8,000
Surface Mount (3 lines)	29F0318-1SR-10	70	119	119	118	119	500	0.01	6,000
Thru-Hole (3 lines)	29F0328-0T0-10	232	342	418	360	420	350	0.01	10,000
Surface Mount (3 lines)	29F0330-2SR-10	125	200	201	160	210	300	0.01	9,000
Surface Mount (4 lines)	29F0418-0SR-10	48	80	80	70	83	300	0.01	6,000
Surface Mount (4 lines)	29F0418-1SR-10	70	119	119	118	119	500	0.01	6,000
Thru-Hole (4 lines)	29F0428-0T0-10	225	342	390	350	400	300	0.01	10,000
Thru-Hole (4 lines)	29F0429-0T0-10	180	245	270	211	280	200	0.01	8,000
Surface Mount (4 lines)	29F0430-2SR-10	120	200	230	225	235	800	0.01	8,000
Surface Mount (4 lines)	29F0430-4SR-10	175	290	268	209	300	200	0.01	9,000
Thru-Hole (5 lines)	29F0528-0T0-10	232	342	418	360	420	350	0.01	10,000
Surface Mount (8 lines)	29F0818-0SR-10	48	75	80	70	83	370	0.01	6,000
Surface Mount (8 lines)	29F0818-1SR-10	70	119	119	118	119	500	0.01	6,000

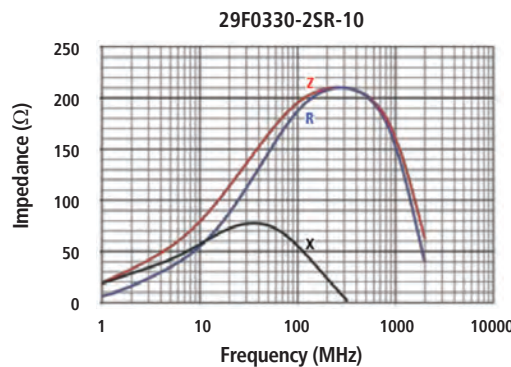
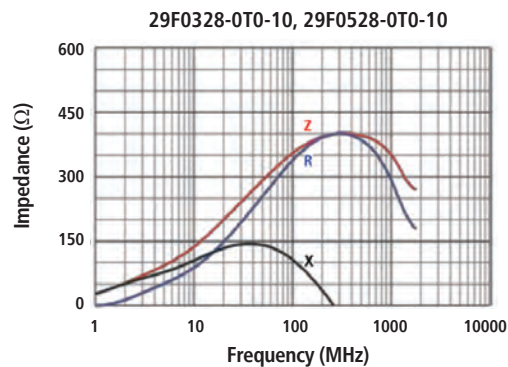
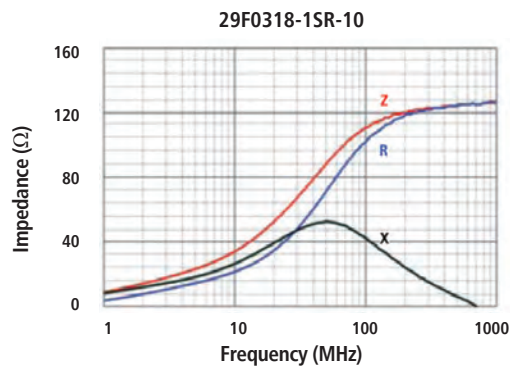
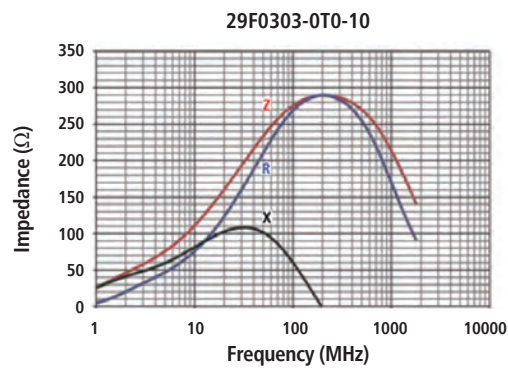

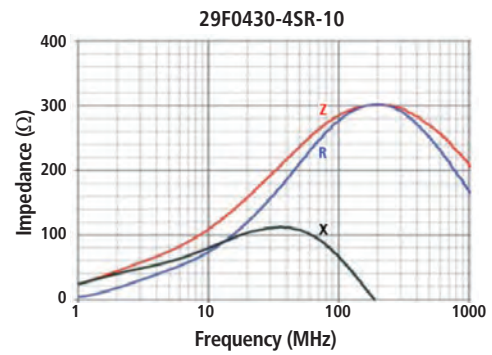
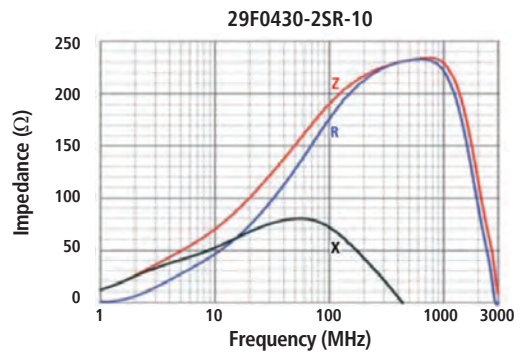
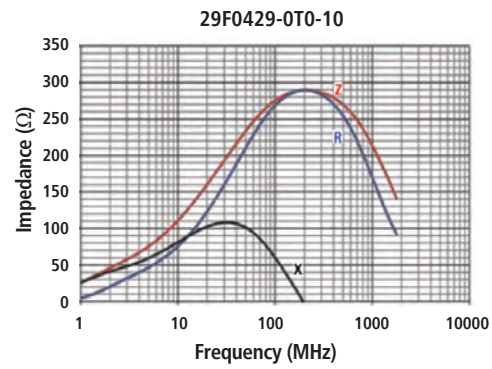
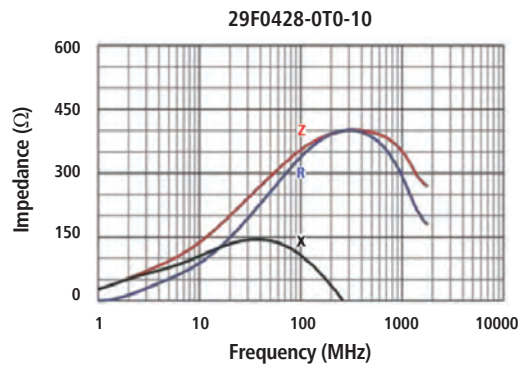
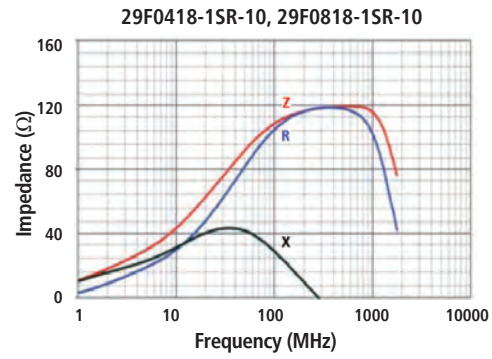
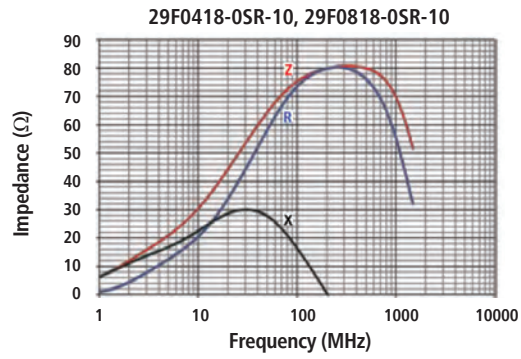

EMI FILTER
ARRAYS

DIMENSION

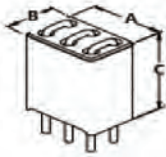
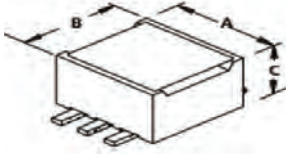
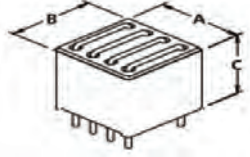
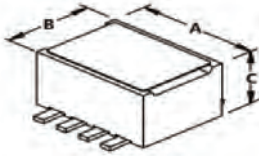
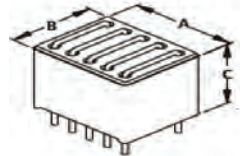
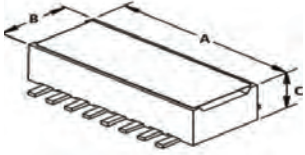
PART NUMBER		# OF LINES	A mm (INCHES)	B mm (INCHES)	C mm (INCHES)	
29F0303-0T0-10	Thru-hole	3	7.62 (0.300)	5.08 (0.200)	10.44 (0.411)	
29F0328-0T0-10		3	8.34 (0.328)	10.88 (0.428)	10.57 (0.416)	
29F0318-1SR-10	Surface-Mount	3	4.83 (0.190)	4.50 (0.177)	4.19 (0.165)	
29F0330-2SR-10		3	8.33 (0.328)	10.87 (0.428)	6.35 (0.250)	
29F0428-0T0-10	Thru-hole	4	10.88 (0.428)	10.88 (0.428)	10.57 (0.416)	
29F0429-0T0-10		4	10.88 (0.428)	5.49 (0.216)	10.44 (0.411)	
29F0418-0SR-10	Surface-Mount	4	6.10 (0.240)	4.50 (0.177)	2.92 (0.115)	
29F0418-1SR-10		4	6.10 (0.240)	4.50 (0.177)	4.19 (0.165)	
29F0430-2SR-10		4	10.87 (0.428)	10.87 (0.428)	6.35 (0.250)	
29F0430-4SR-10		4	10.87 (0.428)	10.87 (0.428)	8.89 (0.350)	
29F0528-0T0-10	Thru-hole	5	13.42 (0.528)	10.88 (0.428)	10.57 (0.416)	
29F0818-0SR-10	Surface-Mount	8	11.43 (0.450)	4.50 (0.177)	2.92 (0.115)	
29F0818-1SR-10		8	11.43 (0.450)	4.50 (0.177)	4.19 (0.165)	

DIFFERENTIAL MODE FILTER
EQUIVALENT CIRCUITS

Diagram #1



Diagram #2

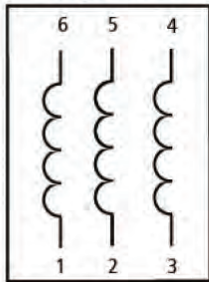

Diagram #3

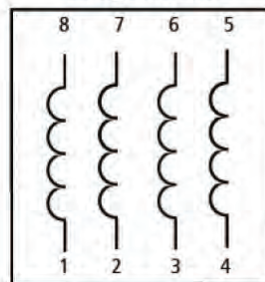

Diagram #4

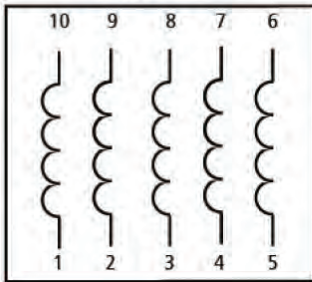
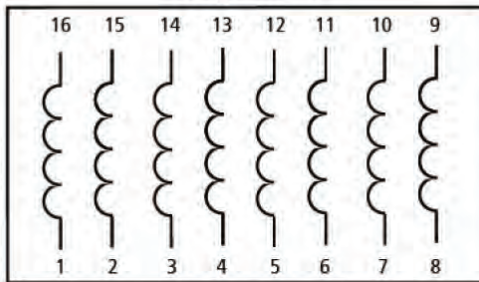

Diagram #5



FERRITE CHIP
INDUCTORS



FEATURES



- Monolithic construction, small size
- High reliability
- Economical
- Broadband and high frequency available
- For RF and wireless communication, computers, telecommunications, automotive electronics etc.

PART NUMBERING SYSTEM

IC	0603	A	102	R	-10
Product Series Code	EIA Size Code	Rated Current Code	Inductance Value Code	Packing Code	Additional Description

EIA PKG. SIZE	METRIC PKG. SIZE	PART NUMBER	L (nH) ± 10%	Q (MIN)	TEST FREQ. L,Q (MHZ)	SELF-RESONANT FREQ. (MHZ)	DCR MAX (Ω)	RATED I MAX (mA)
0603	1608	IC0603A102R-10	1,000	30	10	70	0.6	25
0603	1608	IC0603A103R-10	10,000	30	2	17	2.55	15
0603	1608	IC0603A152R-10	1500	35	10	60	0.70	40
0603	1608	IC0603A472R-10	4700	35	10	33	1.60	30
0603	1608	IC0603A182R-10	1,800	30	10	50	0.95	25
0603	1608	IC0603A681R-10	680	15	25	80	1.7	35
0603	1608	IC0603B181R-10	180	15	25	165	0.6	50
0603	1608	IC0603B470R-10	47	10	50	260	0.3	200
0603	1608	IC0603A821R-10	820	15	25	85	2.10	35
0603	1608	IC0603B820R-10	82	10	50	245	0.3	200
0805	2012	IC0805A103R-10	10,000	45	2	24	1.15	15
0805	2012	IC0805A153R-10	15,000	30	1	19	0.8	5
0805	2012	IC0805A183R-10	18,000	30	1	18	0.9	5
0805	2012	IC0805A223R-10	22,000	30	1	16	1.1	5
0805	2012	IC0805A272R-10	2,700	45	10	45	0.75	30
0805	2012	IC0805A333R-10	33,000	30	0.4	13	1.25	5
0805	2012	IC0805A472R-10	4,700	45	10	35	1	30
0805	2012	IC0805A681R-10	680	25	25	105	0.8	150
0805	2012	IC0805A821R-10	820	25	25	100	1.00	150
0805	2012	IC0805A822R-10	8,200	45	4	26	1.1	15
0805	2012	IC0805B101R-10	100	20	25	235	0.3	250
0805	2012	IC0805B102R-10	1,000	45	10	75	0.4	50
0805	2012	IC0805B122R-10	1200	45	10	65	0.50	250
0805	2012	IC0805B182R-10	1,800	45	10	55	0.6	50
0805	2012	IC0805B222R-10	2,200	45	10	50	0.65	30
0805	2012	IC0805B331R-10	330	20	25	145	0.55	250
0805	2012	IC0805B332R-10	3300	45	10	41	0.80	200
0805	2012	IC0805C470R-10	47	15	50	320	0.2	300
0805	2012	IC0805C680R-10	68	15	50	280	0.2	300
1206	3216	IC1206A103R-10	10,000	50	2	24	1	25
1206	3216	IC1206A332R-10	3,330	45	10	41	0.7	50
1206	3216	IC1206A333R-10	33,000	35	0.4	13	1.05	5
1206	3216	IC1206A472R-10	4,700	45	10	35	0.9	50
1206	3216	IC1206B153R-10	15,000	35	1	19	0.7	5
1206	3216	IC1206B183R-10	18,000	35	1	21	0.7	5
1206	3216	IC1206B331R-10	330	20	25	145	0.5	250
1206	3216	IC1206B821R-10	820	25	25	100	0.9	150

0603 Characteristics

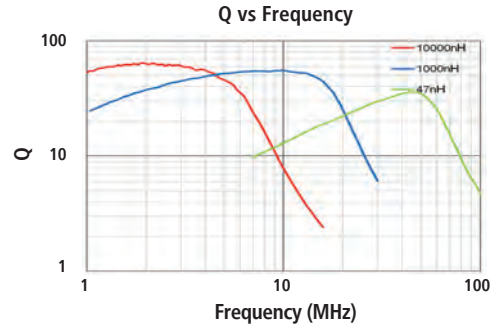
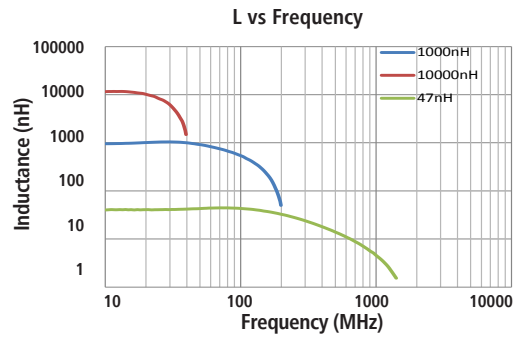

0805 Characteristics

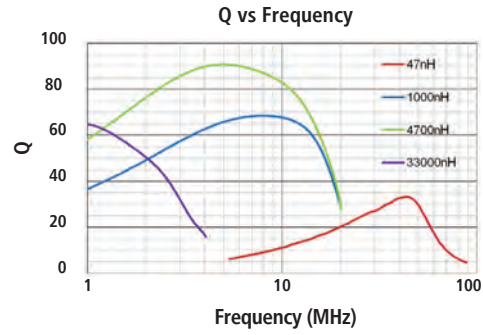
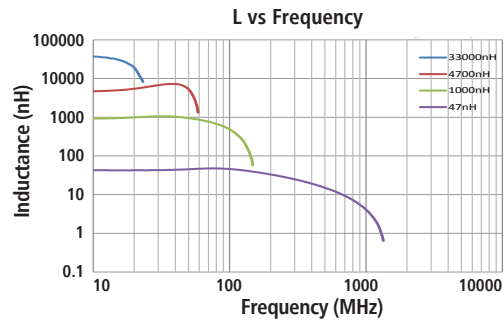

1206 Characteristics

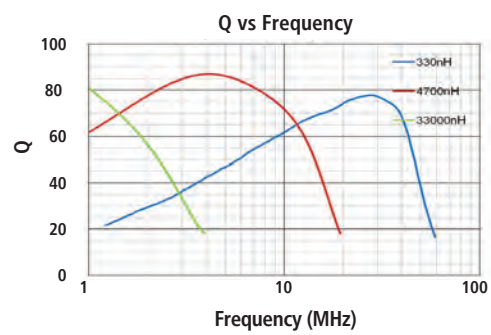
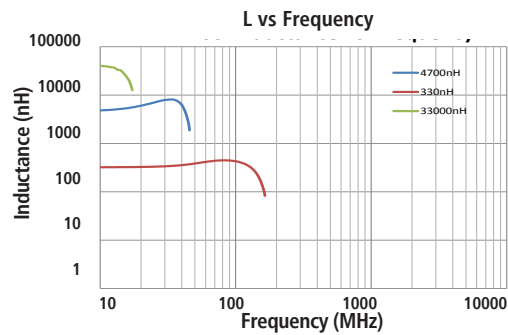

MULTILAYER POWER CHIP INDUCTORS



FEATURES



- Small size (L x W : EIA 0805, 0806 and 1008) with max 1.0 mm in thickness
- Lead-free product and support lead-free soldering
- Applications: mainly for DC-DC converters and power modules. Compact electrical instruments like DSCs, DVCs, PDA, DVD and HDDs, cellular phones
- Operation temperature: -55°C ~ +125°C
- Rated Current Definition: Temperature rise to 40°C max.

PART NUMBERING SYSTEM

CPI	0805	J	R47	R	-1□
Product Series Code	EIA Size Code	Rated Current Code	Inductance Value Code	Packing Code	Additional Description

RATED CURRENT CODE

E = 500 mA F = 600 mA
 G = 700 mA H = 800 mA
 I = 900 mA J = 1000 mA ≤ IDC < 1500 mA
 K = 1500 mA ≤ IDC < 2000 mA

INDUCTANCE VALUE CODE

R47 = 0.47 μH 1R0 = 1.0 μH
 4R7 = 4.7 μH

EIA PKG. SIZE	METRIC PKG. SIZE	PART NUMBER	INDUCTANCE (μH)	INDUCTANCE TOLERANCE	TEST FREQ. (MHz)	DCR (Ω)	RATED CURRENT MAX (mA)
0805	2012	CPI0805JR47R-10	0.47	20%	1	0.10±25%	1100
0805	2012	CPI0805JR68R-10	0.68	20%	1	0.12±25%	1000
0805	2012	CPI0805JR82R-10	0.82	20%	1	0.14±25%	900
0805	2012	CPI0805H1R0R-10	1.0	20%	1	0.16±25%	800
0805	2012	CPI0805H1R2R-10	1.2	20%	1	0.16±25%	800
0805	2012	CPI0805G1R5R-10	1.5	20%	1	0.22±25%	700
0805	2012	CPI0805G1R8R-10	1.8	20%	1	0.22±25%	700
0805	2012	CPI0805F2R2R-10	2.2	20%	1	0.25±25%	600
0805	2012	CPI0805E3R3R-10	3.3	20%	1	0.22±25%	500
0805	2012	CPI0805E4R7R-10	4.7	20%	1	0.30±25%	500
0806	2016	CPI0806KR47R-10	0.47	20%	1	0.14±30%	1500
0806	2016	CPI0806KR68R-10	0.68	20%	1	0.15±30%	1500
0806	2016	CPI0806KR82R-10	0.82	20%	1	0.16±30%	1500
0806	2016	CPI0806J1R0R-10	1.0	20%	1	0.16±30%	1400
0806	2016	CPI0806J1R2R-10	1.2	20%	1	0.16±30%	1400
0806	2016	CPI0806J1R5R-10	1.5	20%	1	0.20±30%	1200
0806	2016	CPI0806J1R8R-10	1.8	20%	1	0.20±30%	1200
0806	2016	CPI0806J2R2R-10	2.2	20%	1	0.22±30%	1200
0806	2016	CPI0806J3R3R-10	3.3	20%	1	0.24±30%	1100
0806	2016	CPI0806J4R7R-10	4.7	20%	1	0.30±30%	1100
1008	2520	CPI1008KR47R-10	0.47	20%	1	0.07±25%	1800
1008	2520	CPI1008KR68R-10	0.68	20%	1	0.09±25%	1700
1008	2520	CPI1008KR82R-10	0.82	20%	1	0.10±25%	1700
1008	2520	CPI1008K1R0R-10	1.0	20%	1	0.11±25%	1600
1008	2520	CPI1008K1R2R-10	1.2	20%	1	0.11±25%	1600
1008	2520	CPI1008K1R5R-10	1.5	20%	1	0.13±25%	1500
1008	2520	CPI1008K1R8R-10	1.8	20%	1	0.13±25%	1500
1008	2520	CPI1008J2R2R-10	2.2	20%	1	0.17±25%	1300
1008	2520	CPI1008J3R3R-10	3.3	20%	1	0.16±25%	1200
1008	2520	CPI1008J4R7R-10	4.7	20%	1	0.20±25%	1100

DIMENSION

METRIC (EIA) PKG. SIZE	A mm (INCHES)	B mm (INCHES)	C* mm (INCHES)	D mm (INCHES)	MONOLITHIC POWER CHIP INDUCTOR
2012 (0805)	2.00±0.20 (0.079±0.008)	1.25±0.20 (0.049±0.008)	0.9±0.10 (0.035±0.004)	0.5±0.20 (0.02±0.008)	
2016 (0806)	2.00±0.15 (0.079±0.006)	1.60±0.15 (0.063±0.006)	0.9±0.10 (0.035±0.004)	0.5±0.20 (0.02±0.008)	
2520 (1008)	2.50±0.20 (0.098±0.008)	2.00±0.20 (0.079±0.008)	0.9±0.10 (0.035±0.004)	0.6±0.20 (0.024±0.008)	

MULTILAYER POWER CHIP
INDUCTORS

0805 Characteristics

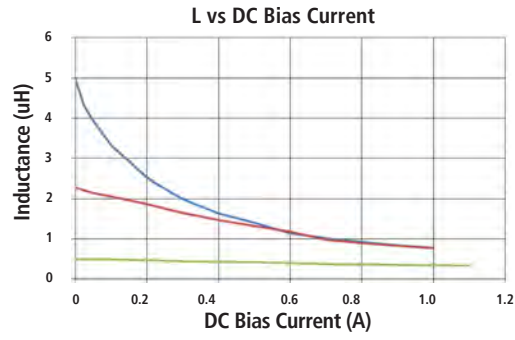
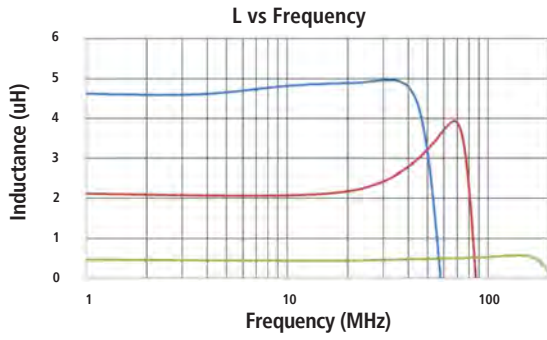

- CPI0805E4R7R-10
- CPI0805F2R2R-10
- CPI0805JR47R-10

0806 Characteristics

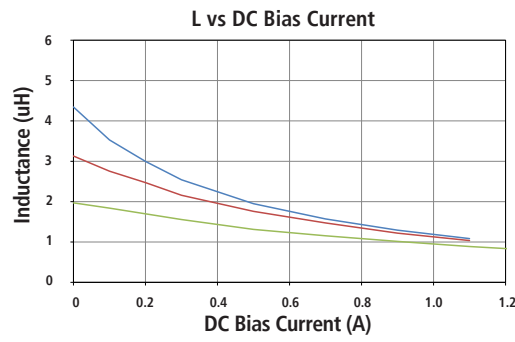
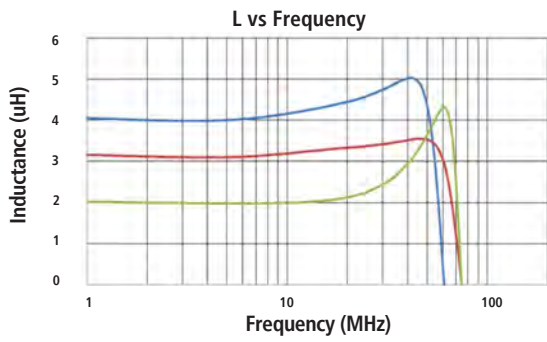

- CPI0806J4R7R-10
- CPI0806J3R3R-10
- CPI0806J2R2R-10

1008 Characteristics

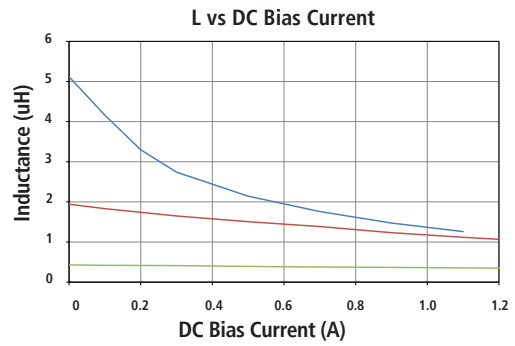
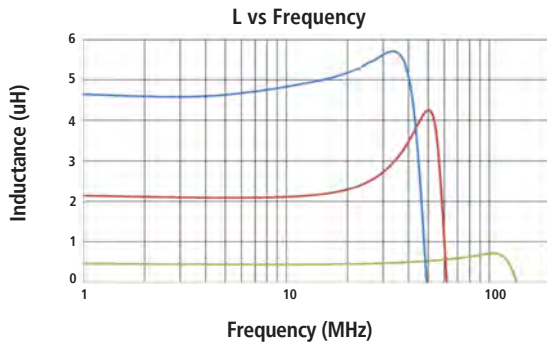

- CPI1008J4R7R-10
- CPI1008J2R2R-10
- CPI1008KR47R-10

ANTENNAS & RECEPTION | EMBEDDED WIRELESS | EMI | TELEMATICS | THERMAL | WIRELESS AUTOMATION & CONTROL



Smart Technology. Delivered.

Americas: +1 800 634.2673 Option 1

Europe: +420 488.575277

Asia: +86 757.2563.8860

www.lairdtech.com

MCP-CAT-EMI FILTERING RF \$+&\$%+

Any information furnished by Laird and its agents is believed to be accurate and reliable. All specifications are subject to change without notice. Responsibility for the use and application of Laird materials rests with the end user, since Laird and its agents cannot be aware of all potential uses. Laird makes no warranties as to the fitness, merchantability or suitability of any Laird materials or products for any specific or general uses. Laird, Laird Technologies, Inc or any of its affiliates or agents shall not be liable for incidental or consequential damages of any kind. All Laird products are sold pursuant to the Laird Technologies' Terms and Conditions of sale in effect from time to time, a copy of which will be furnished upon request. © Copyright 2017 Laird Technologies, Inc. All Rights Reserved. Laird, Laird Technologies, the Laird Logo, and other marks are trademarks or registered trademarks of Laird Technologies, Inc. or an affiliate company thereof. Other product or service names may be the property of third parties. Nothing herein provides a license under any Laird or any third party intellectual property rights.

X-ON Electronics

Largest Supplier of Electrical and Electronic Components

Click to view similar products for [Ferrite Beads](#) category:

Click to view products by [Laird Connectivity](#) manufacturer:

Other Similar products are found below :

[CZB1EGTTP700P](#) [CZB1JGTTD101P](#) [CZB1JGTTD151P](#) [CZB1JGTTD601P](#) [CZB2AFTTD800P](#) [CZB2AGTTD601P](#) [CZB2BFTTE600P](#)
[EMI0805R-11](#) [NCB0603R301TR050F](#) [NCB0805A320TR050F](#) [NCB-H1206B680TR300F](#) [SMB2.5-1TR](#) [SMB2.5R-2](#) [2943778301](#)
[CZB1EGTTP121P](#) [CZB1JGTTD102P](#) [CZB1JGTTD121P](#) [CZB1JGTTD221P](#) [CZB2AGTTD301P](#) [CZB2BFTTE601P](#) [4221R-1](#) [4221R-2](#)
[4221R-3](#) [432703041971](#) [EMI0805R-2000](#) [EMI0805R-600](#) [SBY100505T-100Y-N](#) [NCB-GH0402D121TR060F](#) [NCB-H1812D125TR150F](#)
[CZB2AGTTD102P](#) [NCB0402P301TR005F](#) [NCB0603R152TR030F](#) [NCB0805A121TR050F](#) [NCB3312K900TR500F](#) [NCB-](#)
[H0805A102TR150F](#) [NCB-H0805A221TR300F](#) [NCB-H1806E181TR300F](#) [NCB0402P300TR030F](#) [NCB0402P700TR050F](#)
[NCB0805A102TR040F](#) [NCB1806E151TR020F](#) [NCB-H0603R121TR300F](#) [NCB-H0805A220TR600F](#) [NCB-H0805A390TR400F](#)
[CIM21J252NE](#) [CZB2BFTTE121P](#) [EMI0805R-220](#) [74279250](#) [7427924](#) [CZB1JGTTD202P](#)