



Laird Technologies ,Co., Ltd.

SPECIFICATION FOR APPROVAL

Customer : All

Manufacturer : Laird Technologies Co.,Ltd.

Product : Molding Power Inductor

Laird P/N : **MGV1205 Series**

Customer P/N : N/A

Issued Date : 2018.2.8

Rev : **A**

Customer Response

Approved By:	Signature:	Date:

Laird Signature

Approved By	Checked By	Prepared By
<i>Chiang</i>	<i>Siemens Mi</i>	<i>Denny Chen</i>

Laird (Foshan) Magnetics Co., Ltd.

Fu'an Industrial Zone, Leliu Town, Shunde, Foshan City, Guangdong, China 528322

Tel: +86 (757) 25638860 Fax: +86 (757) 25638862

ISO 9001
ISO14001
OHSAS18001

Email: china@lairdtech.com Website: www.lairdtech.com



SPECIFICATION FOR APPROVAL

1.MECHANICAL & DIMENSIONS

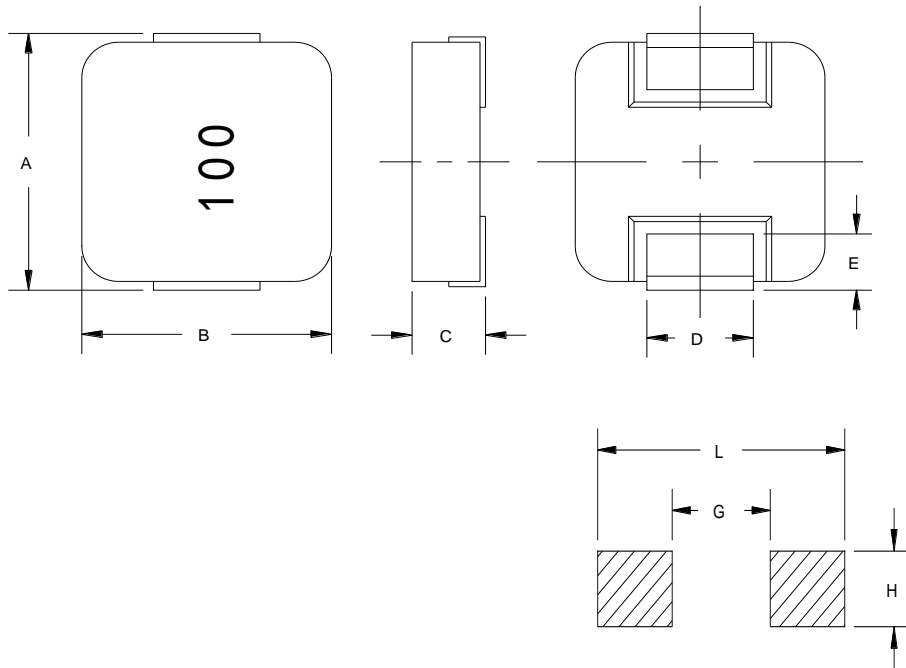

(UNIT: mm)	
A	13.50±0.50
B	12.60±0.40
C	5.00±0.40
D	4.70±0.30
E	2.30±0.30
L	14.20 ref
G	8.00 ref
H	5.00 ref
REMARK	

2.PART NUMBER NOMENCLATOR:

MGV 1205 100 M - 1X
A B C D E

A: Product Series.
 B: Series number, part size
 C: Inductance code

D: Inductance Tolerance. (M=±20% ,N=±30%)
 E: "X"=0:Standard catalog part number
 "X"=1-9:Controlled customized part **OR** different performance than std catalog part. And "5-9" is for automotive grade.

3.EQUIVALENT CIRCUIT:

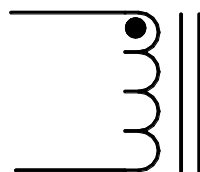

**SPECIFICATION FOR APPROVAL**

PART NUMBER	INDUCTANCE (uH)±20%	Irms(A) Typ	Isat(A) Typ.	DCR(mΩ) Typ	DCR(mΩ) Max	REMARK
MGV1205R22M-10	0.22	52.0	110	0.50	0.70	
MGV1205R33M-10	0.33	42.0	80.0	0.70	0.90	
MGV1205R47M-10	0.47	38.0	65.0	0.86	1.10	
MGV1205R56M-10	0.56	36.0	55.0	1.00	1.50	
MGV1205R68M-10	0.68	34.0	54.0	1.40	1.70	
MGV1205R82M-10	0.82	31.0	52.0	1.70	2.10	
MGV12051R0M-10	1.00	29.0	50.0	1.85	2.50	
MGV12051R5M-10	1.50	27.0	48.0	2.80	3.30	
MGV12051R8M-10	1.80	21.0	40.0	4.00	4.90	
MGV12052R2M-10	2.20	20.0	32.0	4.20	5.50	
MGV12053R3M-10	3.30	15.0	32.0	6.80	9.20	
MGV12054R7M-10	4.70	12.0	27.0	11.4	15.0	
MGV12055R6M-10	5.60	11.5	22.0	12.3	16.5	
MGV12056R8M-10	6.80	11.0	21.0	14.5	18.5	
MGV12058R2M-10	8.20	9.5	18.0	16.8	22.5	
MGV1205100M-10	10.00	9.0	16.0	21.4	25.5	
MGV1205150M-10	15.00	8.2	13.0	32.0	38.0	
MGV1205220M-10	22.00	6.5	10.0	50.0	58.0	
MGV1205330M-10	33.00	5.0	8.0	73.0	88.0	

GENERAL SPECIFICATION:

- 1, Test conditions(L): 100KHz, 1Vrms
- 2, Operating temperature: -55°C to +125°C(Including self-heating)
- 3, Storage temperature: -10°C to +40°C
- 4, Humidity range: 60% RH Max.
- 5, Heat Rated Current (Irms) will cause the coil temperature rise approximately Δt of 40°C
- 6, Saturation Current (Isat) will cause L0 to drop approximately 30%.
- 7, Part Temperature (Ambient+Temp. Rise) : Should not exceed 125°C under worst case operating condi
- 8, Storage condition (component in its packaging)

SPECIFICATION FOR APPROVAL

Characteristics Curve

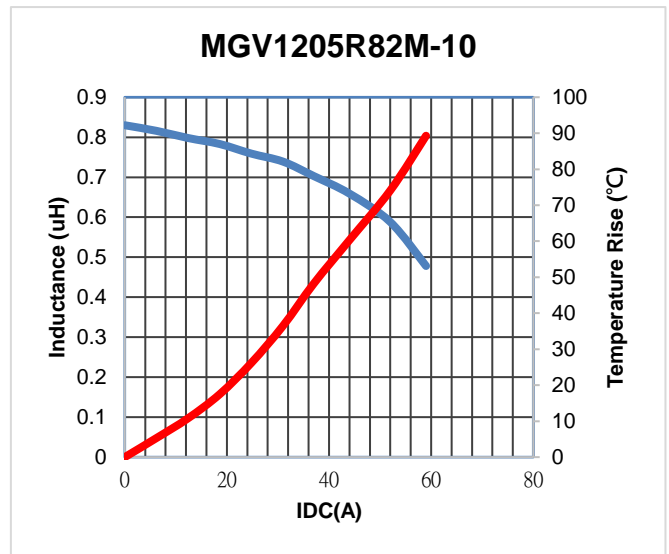
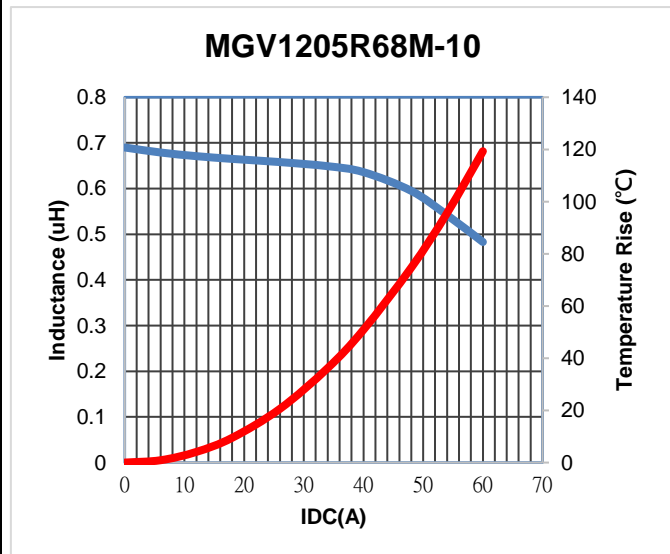
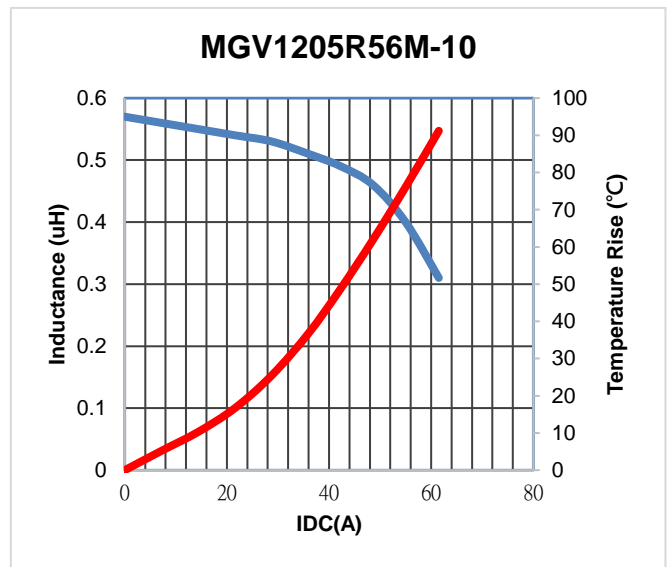
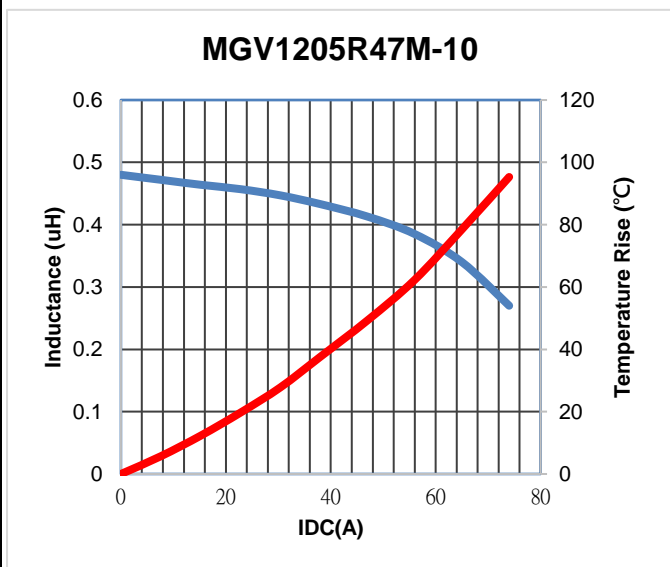
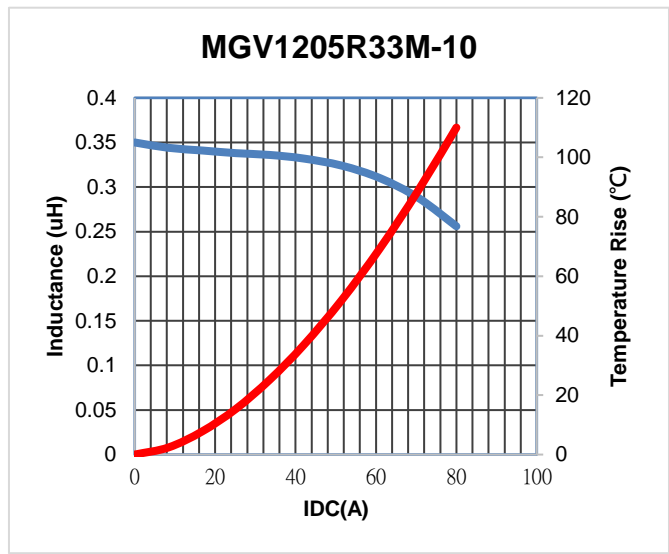
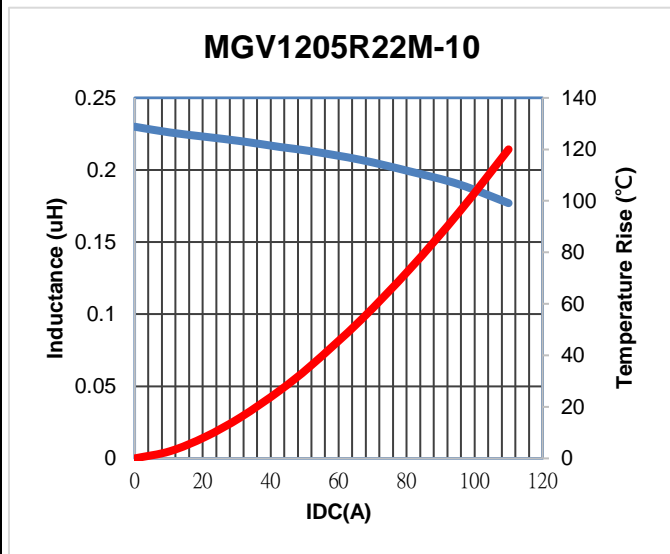

SPECIFICATION FOR APPROVAL

Characteristics Curve

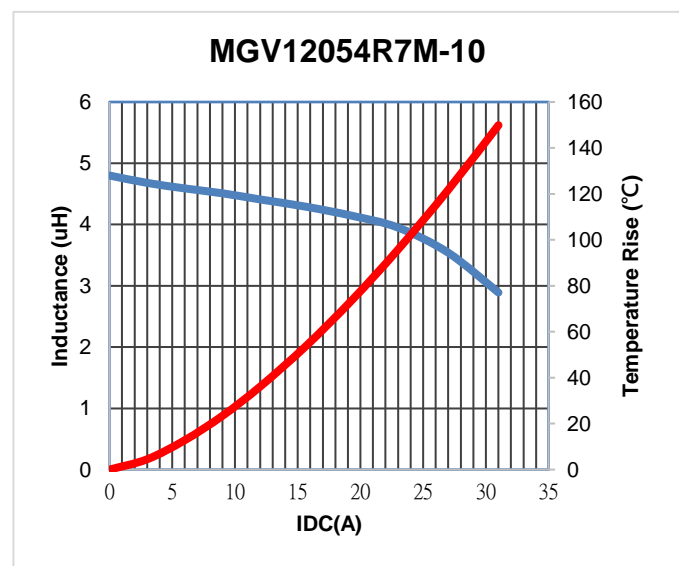
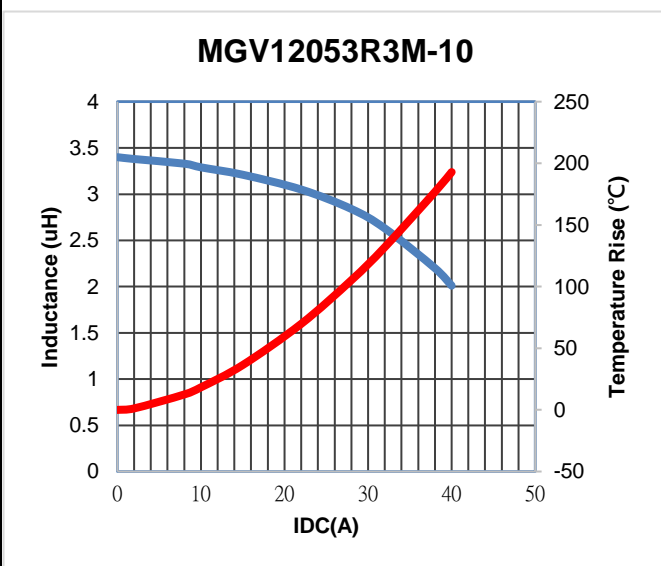
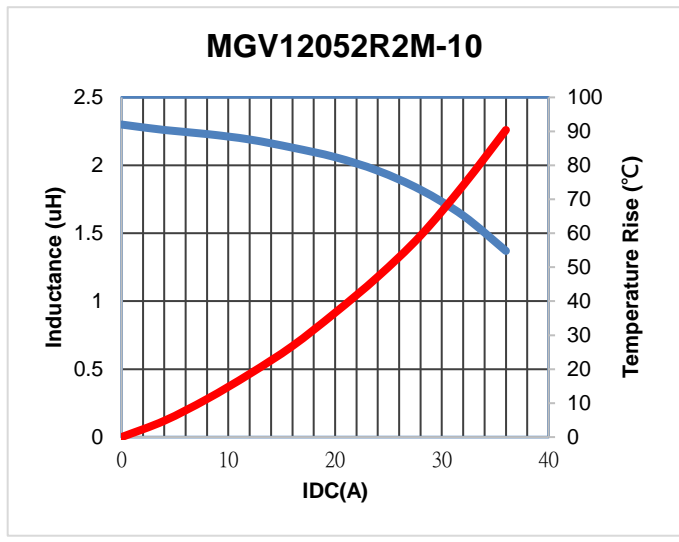
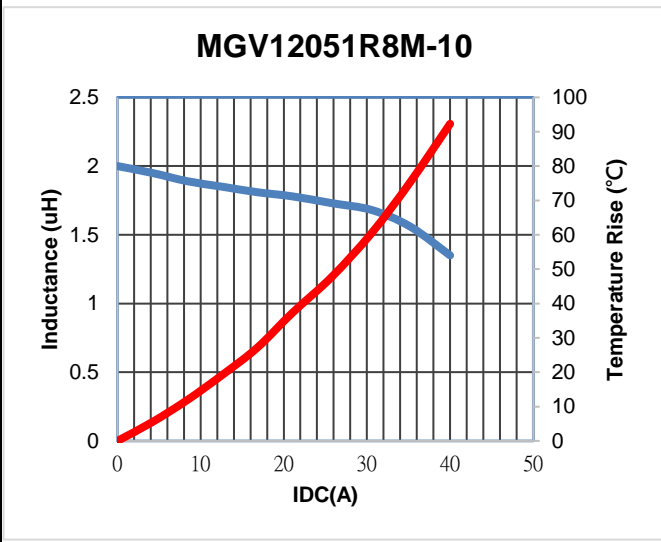
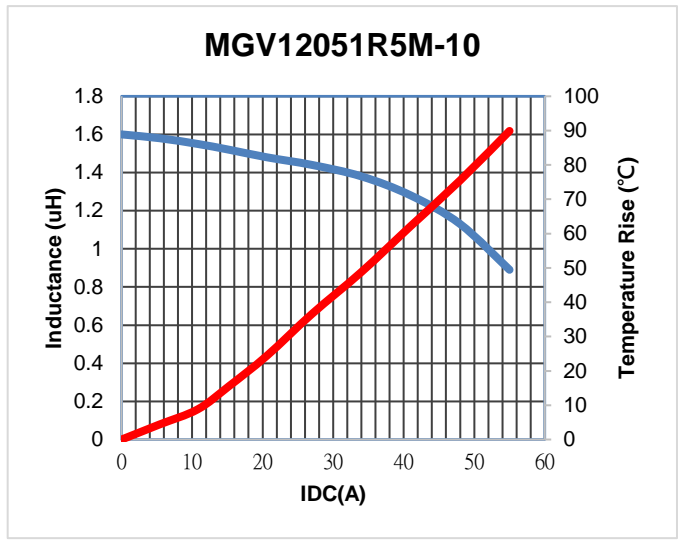
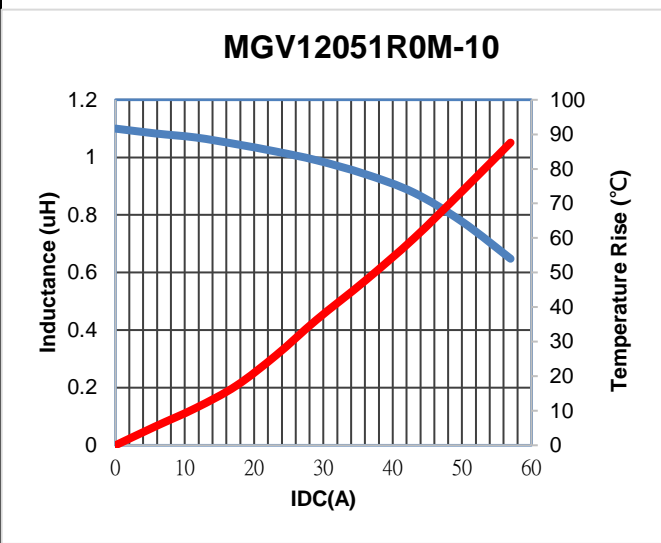

SPECIFICATION FOR APPROVAL

Characteristics Curve

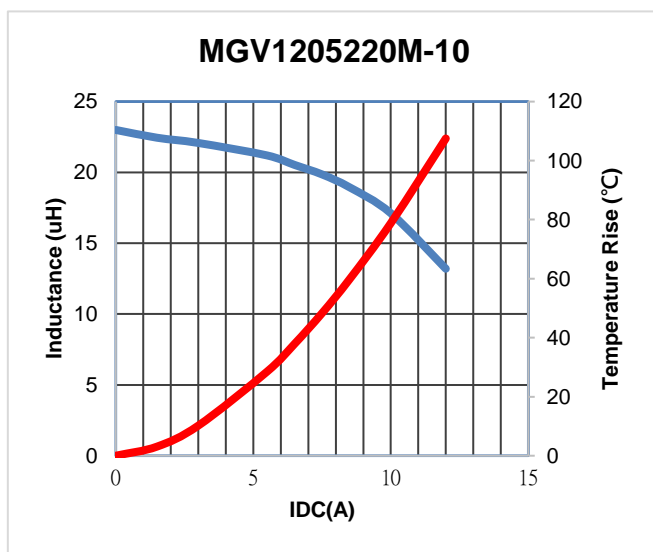
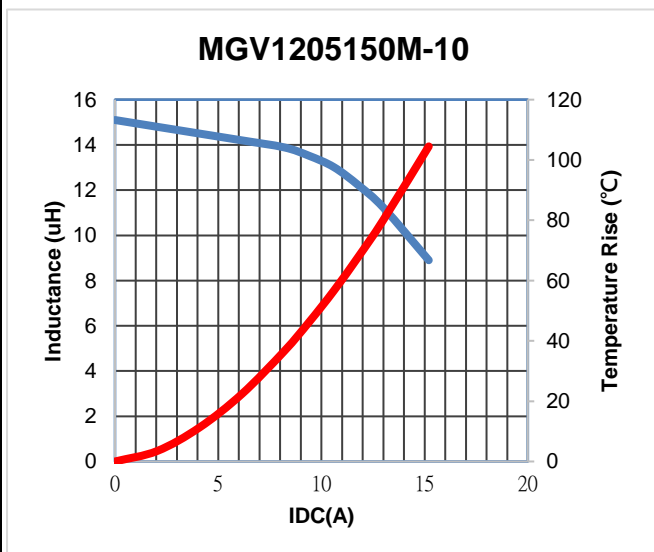
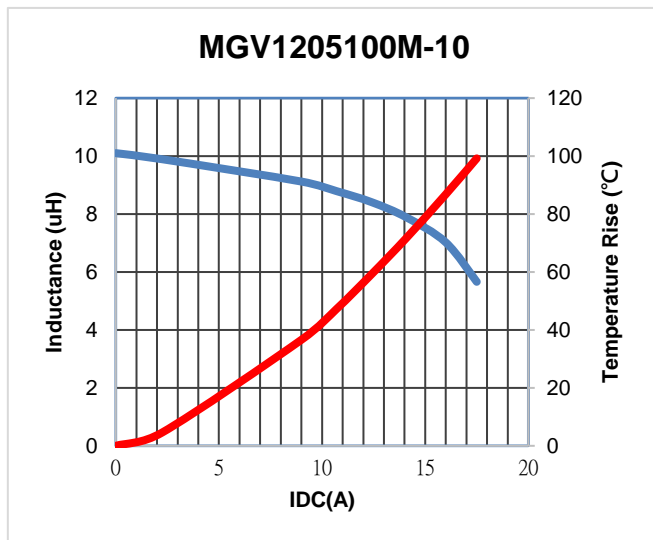
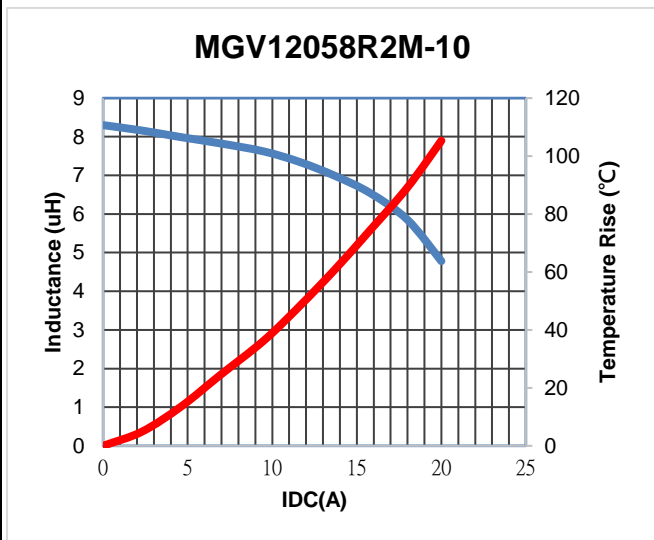
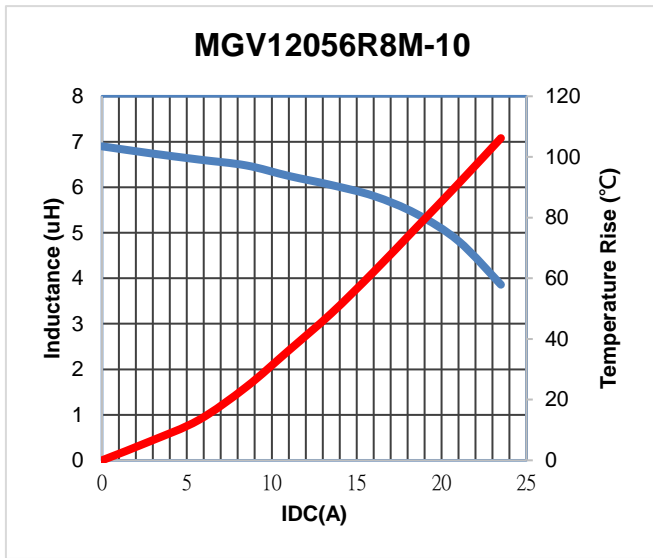
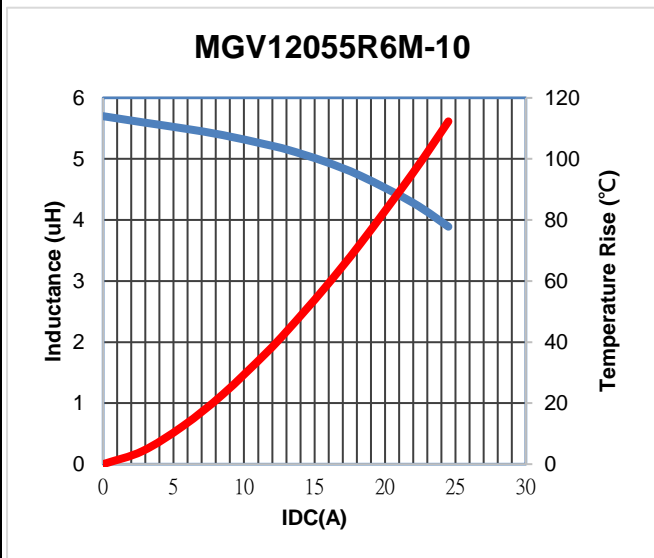

SPECIFICATION FOR APPROVAL

Characteristics Curve

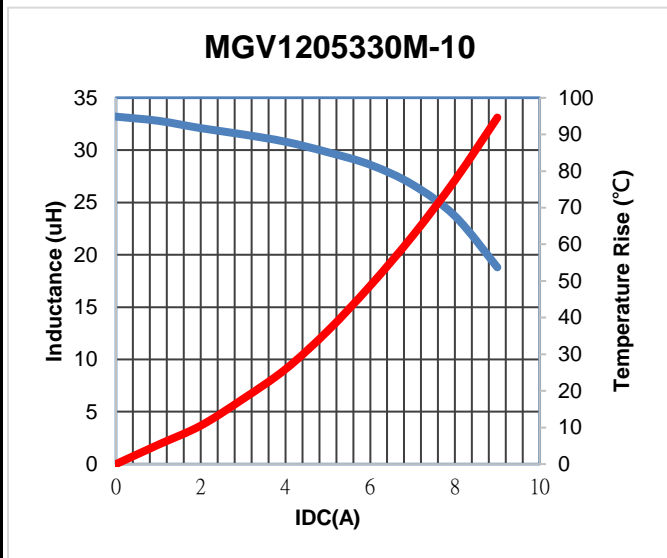



Recommended Soldering Conditions

For Lead-Free Application

Figure 1 . Re-flow Soldering

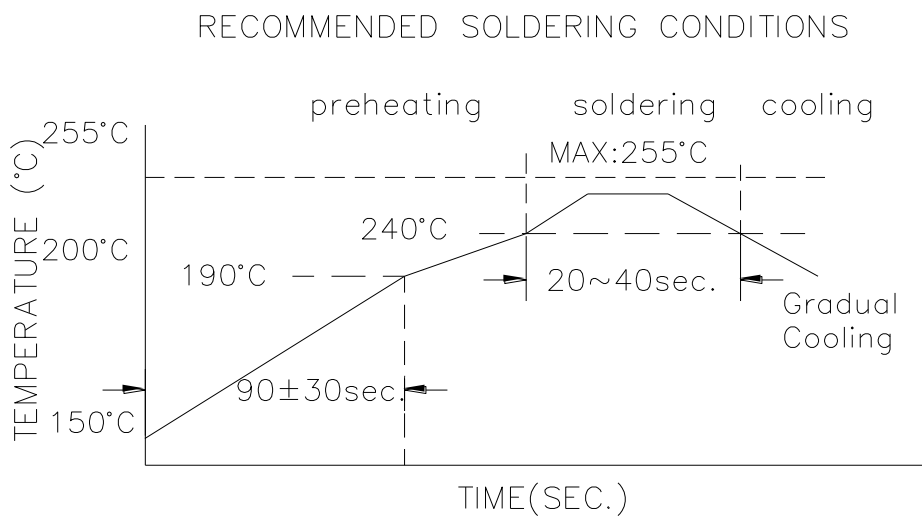

Reflow times: 3 times max

Figure 2 . Hand Soldering

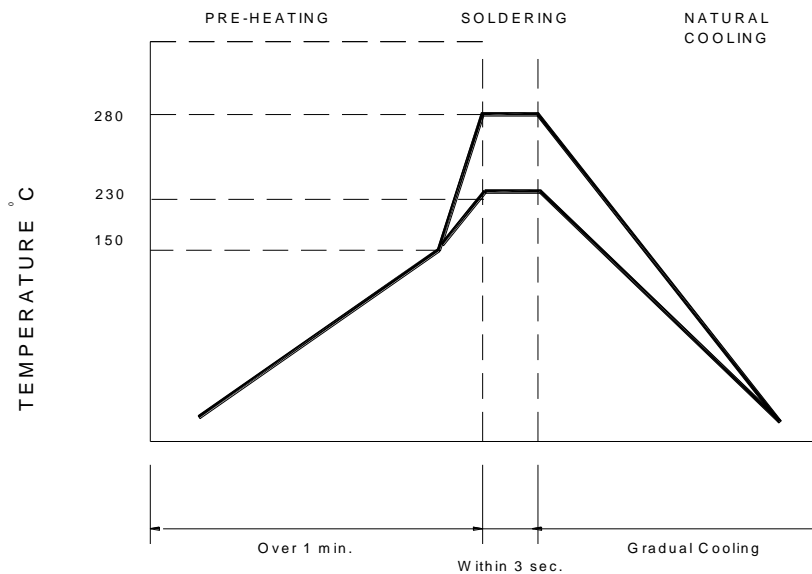

Hand solder times: 1 time max



Reliability and Testina Conditions / Pin Type Power Inductors

SMD series(Consumer)

Item	Reference	Additional Requirements
Operating temperature range	-55°C ~ +125°C (Including self-temperature rise)	
Storage temperature and humidity range	-10°C to +40°C , 60% RH Max	
High Temperature Exposure (Storage)	MIL-STD-202 Method 108	85±2°C, 168+24hours
Temperature Cycling	JESD22 Method JA-104	-40°C → +85, transforming interval:20s, 100cycles
Operational Life	MIL-PRF-2	85±°C, 168+24hours Apply maximum rated voltage and current according part drawing
External Visual	MIL-STD-883 Method 2009	Inspect device construction, marking and workmanship. Electrical Test not required.
Physical Dimension	JESD22 Method JB-100	Verify physical dimensions to the applicable device detail specification. Note: User(s) and Suppliers spec. Electrical Test not required
Vibration	MIL-STD-202 Method 204	10~55Hz,1.5mm, 2 hours in each 3mutually
Resistance to Soldering Heat	MIL-STD-202 Method 210	1. Max. 260±5°C,10±1s, 2 times 2.Solder Composition: Sn/3Ag/0.5Cu
Solderability	J-STD-002	245±5°C, 5±1sec, Solder: Sn/3.0Ag/0.5Cu
Electrical Characterization	Print Spec	Parametrically test per lot and sample size requirements, summary to show Min, Max, Mean and Standard deviation at room as well as Min and Max Operating temperatures
Board Flex	AEC-Q200-005	2mm,30±1s
Terminal Strength(SMD)	AEC-Q200-006	10N, 5S, X,Y direct

PACKAGING

Reel Dimension

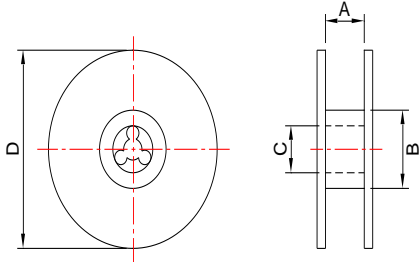

Type	A(mm)	B(mm)	C(mm)	D(mm)
13'x24	24.4+2/-0	100 ± 2	13+0.5/-0.2	330

Tape Dimension

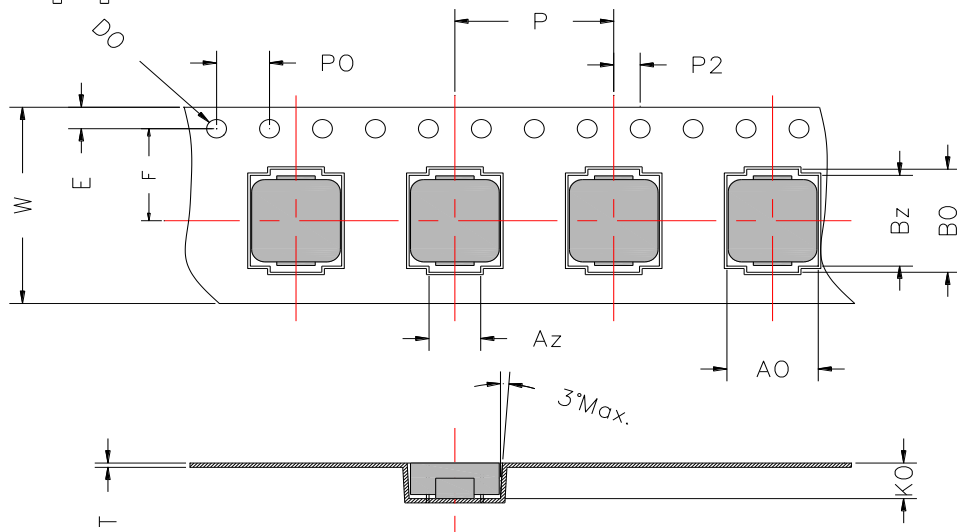

W	E	F	P	A0	B0	P2	P0	K0	t	D0	Az	Bz
24.0±0.3	1.75±0.1	11.50±0.1	16.00±0.1	12.9±0.1	14.10±0.1	2.0±0.1	4.0±0.1	7.0±0.1	0.35±0.05	1.5Ref.	7.0±0.1	13±0.1

Packaging Quantity

P/N	Chip/Reel
MGV1205 Series	500pcs
Size	

Peeling Off Force

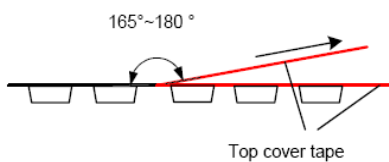

The force peeling off cover tape is 10 to 100 grams			
in the arrow direction under the following conditions			
Room Temp (°C)	Room Humidity	Room atrn (hPa)	Teaming Speed
5~35	45~85	860~1060	300

※Storage Conditions

1. Temperature and humidity conditions: -10-+40°C and 60% RH.
2. Recommended products should be used within 12 mont from the time of manufacturing.
3. The packaging material should be kept where no chlorin or sulfur exists in the air.
4. Allowable stacking condition of Packaging box: max height 1.5m or 5 boxes stacking



SPECIFICATION FOR APPROVAL

MATERIAL IDENTIFICATION

ITEM	DESCRIPTION	Spec	SGS No.	SUPPLIERS
1	Powder	Iron Powder	SCL03H001687001	Laird
2	Copper Wire	AIB	SCL01G06040701E	PACIFIC
3	Coating	Paint	RHS01G006468001	BERLIN
4	Clip	Clip	CAN1406178103	HUIGAO

X-ON Electronics

Largest Supplier of Electrical and Electronic Components

Click to view similar products for [Fixed Inductors](#) category:

Click to view products by [Laird Connectivity](#) manufacturer:

Other Similar products are found below :

[CR43NP-680KC](#) [CR54NP-820KC](#) [CR54NP-8R5MC](#) [CTX32CT-100](#) [70F224AI](#) [MGDQ4-00004-P](#) [MHL1ECTTP18NJ](#) [MHL1JCTTD12NJ](#)
[PE-51506NL](#) [PE-53601NL](#) [PE-53602NL](#) [PE-53630NL](#) [PE-53824SNLT](#) [PE-92100NL](#) [PG0434.801NLT](#) [PG0936.113NLT](#) [9310-16](#) [PM06-2N7](#) [PM06-39NJ](#) [A01TK](#) [1206CS-471XJ](#) [HC2-2R2TR](#) [HC2LP-R47-R](#) [HC3-2R2-R](#) [1206CS-151XG](#) [RCH664NP-140L](#) [RCH664NP-4R7M](#)
[RCH8011NP-221L](#) [RCP1317NP-332L](#) [RCP1317NP-391L](#) [RCR1010NP-470M](#) [RCR110DNP-331L](#) [DH2280-4R7M](#) [DS1608C-106](#) [ASPI-4020HI-R10M-T](#) [B10TJ](#) [B82477P4333M](#) [B82498B3101J000](#) [B82498B3680J000](#) [ELJ-RE27NJF2](#) [1812CS-153XJ](#) [1812CS-183XJ](#) [1812CS-223XJ](#) [1812LS-104XJ](#) [1812LS-105XJ](#) [1812LS-124XJ](#) [1812LS-154XJ](#) [1812LS-223XJ](#) [1812LS-224XJ](#) [1812LS-563XJ](#)