



The user experience requirements will become more demanding over the next couple of years. The resources of today's mobile broadband networks are becoming insufficient as operators offer broadband multimedia access anywhere to meet the increased demand. Long Term Evolution (LTE) promises to fulfill the requirements set on future networks by delivering ultra-fast broadband services with increased cell capacity.

This M2M LTE MIMO antenna features wide bandwidth as a solution to cover 617 MHz to 960 MHz and 1350 MHz to 2700 MHz. The MTRA61274CB2 antenna is the ideal choice when multiple bandwidths are required in various regional and global applications.

### FEATURES AND BENEFITS

- Covers 617-960 MHz and 1350-2700 MHz
- Operates simultaneously in more than eleven frequency bands supporting – LTE, cellular, Quadband GSM+UMTS / 3G, AWS, WI-FI, WLAN, WISP, and WIMAX
- Vertical polarization
- Omnidirectional gain patterns
- RoHS-compliant

### APPLICATIONS

- LTE
- GSM 850/900
- GSM 1800/1900
- UMTS/WCMDA (3G)
- 802.11 b/g/n WLAN applications
- Bluetooth® devices

### ELECTRICAL SPECIFICATIONS

Antenna Model	MTRA61274Cx2									
Number of Ports	2 (2 ports LTE)									
Operating Frequency (MHz)	617-698	698-824	824-894	880-960	1350-1550	1690-1880	1850-1990	1910-2180	2300-2500	2500-2700
Peak Gain – Average (dBi)**	2.4	3.1	2.8	2.7	2.7	3.6	3.9	3.5	3.6	2.9
Peak Gain – Max (dBi)**	3.2	4.0	4.0	3.4	4.7	4.1	4.1	4.2	4.0	3.4
VSWR – Max*	2.5									
VSWR – Average*										
Port 1	1.4	1.8	1.9	1.9	1.5	1.3	1.4	1.8	1.8	1.9
Port 2	1.4	1.8	1.9	1.9	1.5	1.3	1.4	1.8	1.8	1.8
Port-to-Port Isolation LET1-to-LTE2	-8	-10	-10	-10	-15	-17	-18	-18	-18	-25
Nominal Impedance (Ohms)	50									
Polarization	Linear vertical									
Azimuth Beamwidth (°)	360, Omnidirectional									
Max Power - Ambient 25°C (W)	50									

\*\* - Measured on a one-foot ground plane.

### MECHANICAL SPECIFICATIONS

Dimensions – L x W x H – mm (inches)	130 x 84 x 95 (5.12 x 3.31 x 3.74)
Weight – g (oz.)	343 (12.1)
Radome/Baseplate Material	PC, UL94 V0 Rating, UV Stable

### ENVIRONMENTAL SPECIFICATIONS

Operating Temperature – °C (°F)	-30 to +70°C (-22 to +158°F)
Storage Temperature – °C (°F)	-40 to +85°C (-40 to +185°F)
Material Substance Compliance	RoHS
Ingress Protection	IP67 (when installed on a hard, flat surface)

CONFIGURATION

PART NUMBER	CABLE TYPE	CABLE LENGTH	CONNECTOR	COLOR
MTRA61274CB2-001	LMR195M	610 mm (24 in.)	SMA- male	Black
MTRA61274CW2-001	LMR195M	610 mm (24 in.)	SMA- male	White

**Note:** Specifications vary with different types of cable, different lengths of cables and connectors. Contact Laird for detailed specifications.

PACKAGING INFORMATION

PACKAGED DIMENSIONS	MASTER CARTON	AIR PALLET	OCEAN PALLET
Number of Antennas	20	480	600
Height – cm (in.)	30.0 (11.8)	135 (53.2)	165 (65.0)
Length – cm (in.)	52.5 (20.7)	105 (41.3)	105 (41.3)
Width – cm (in.)	26.5 (10.4)	79.5 (31.3)	79.5 (31.3)
Shipping Weight – kg (lbs.)	7.36 (16.2)	190 (419)	230 (507)

MECHANICAL DRAWING

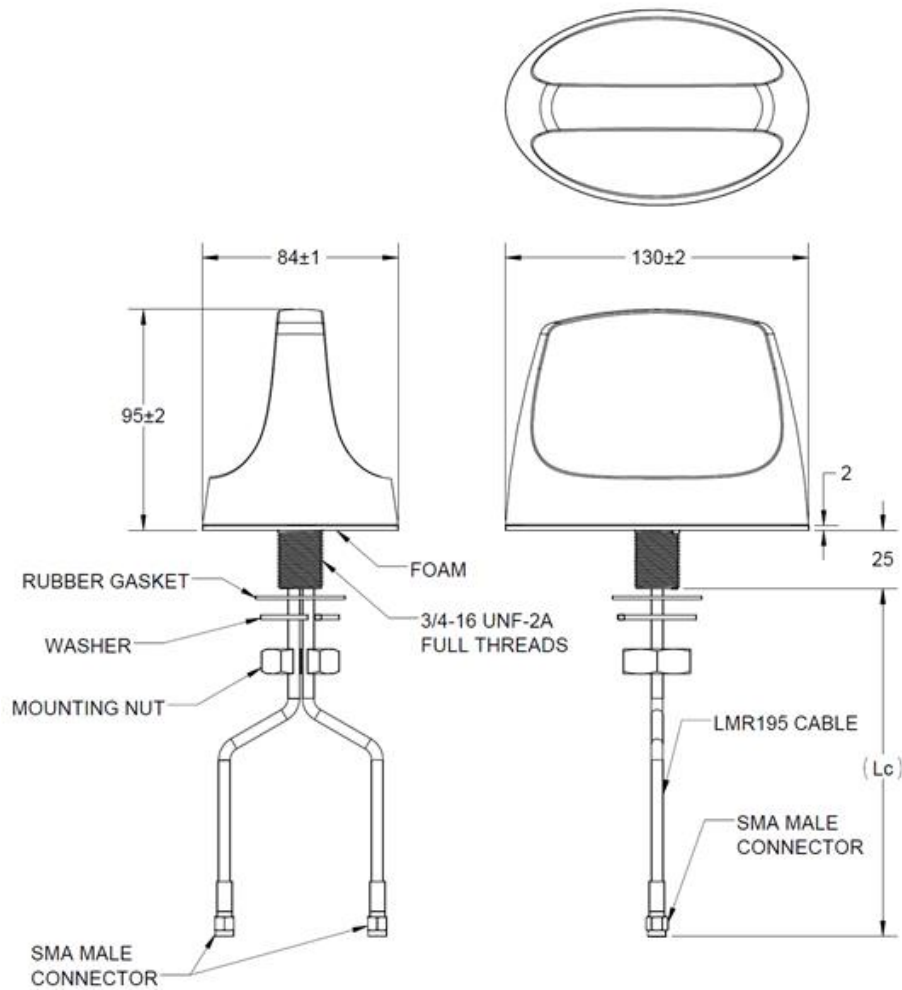

RADIATION PATTERNS

Azimuth Plane - Theta 90°

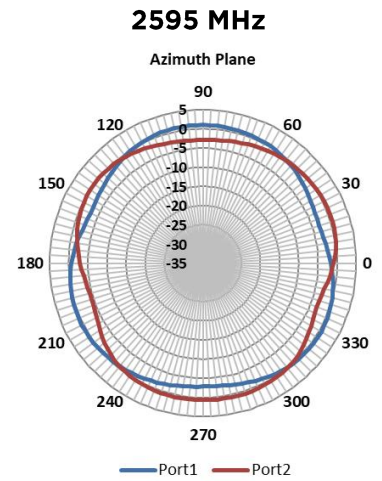
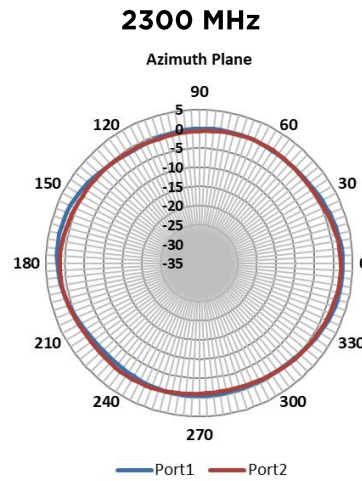
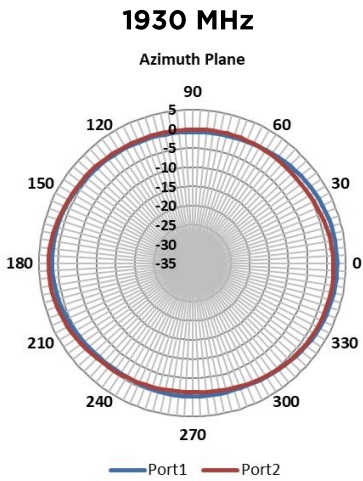
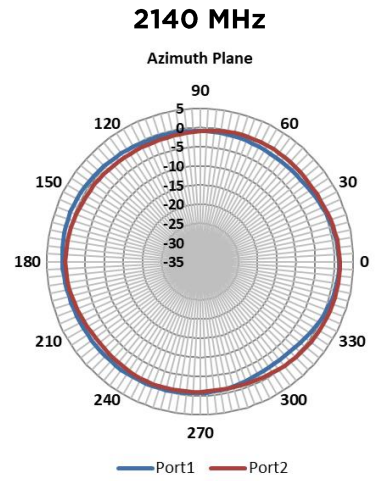
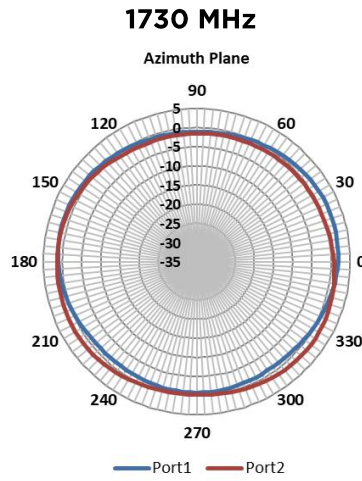
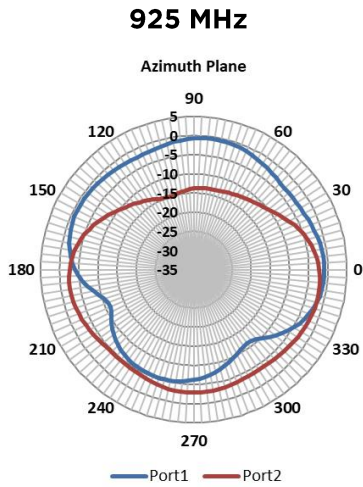
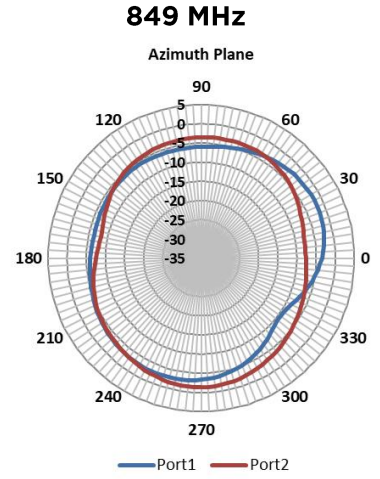
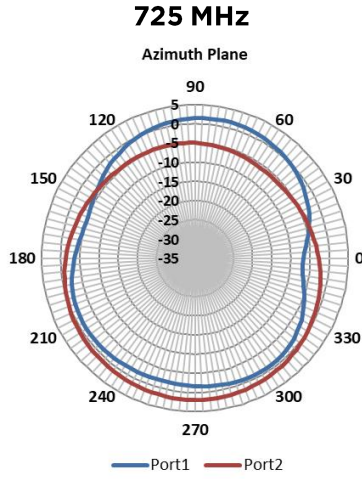
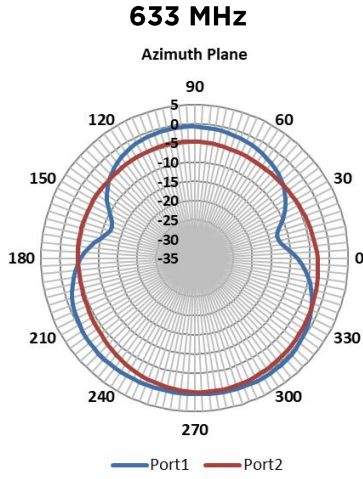



RADIATION PATTERNS

Elevation Plane 0° - Phi 0°

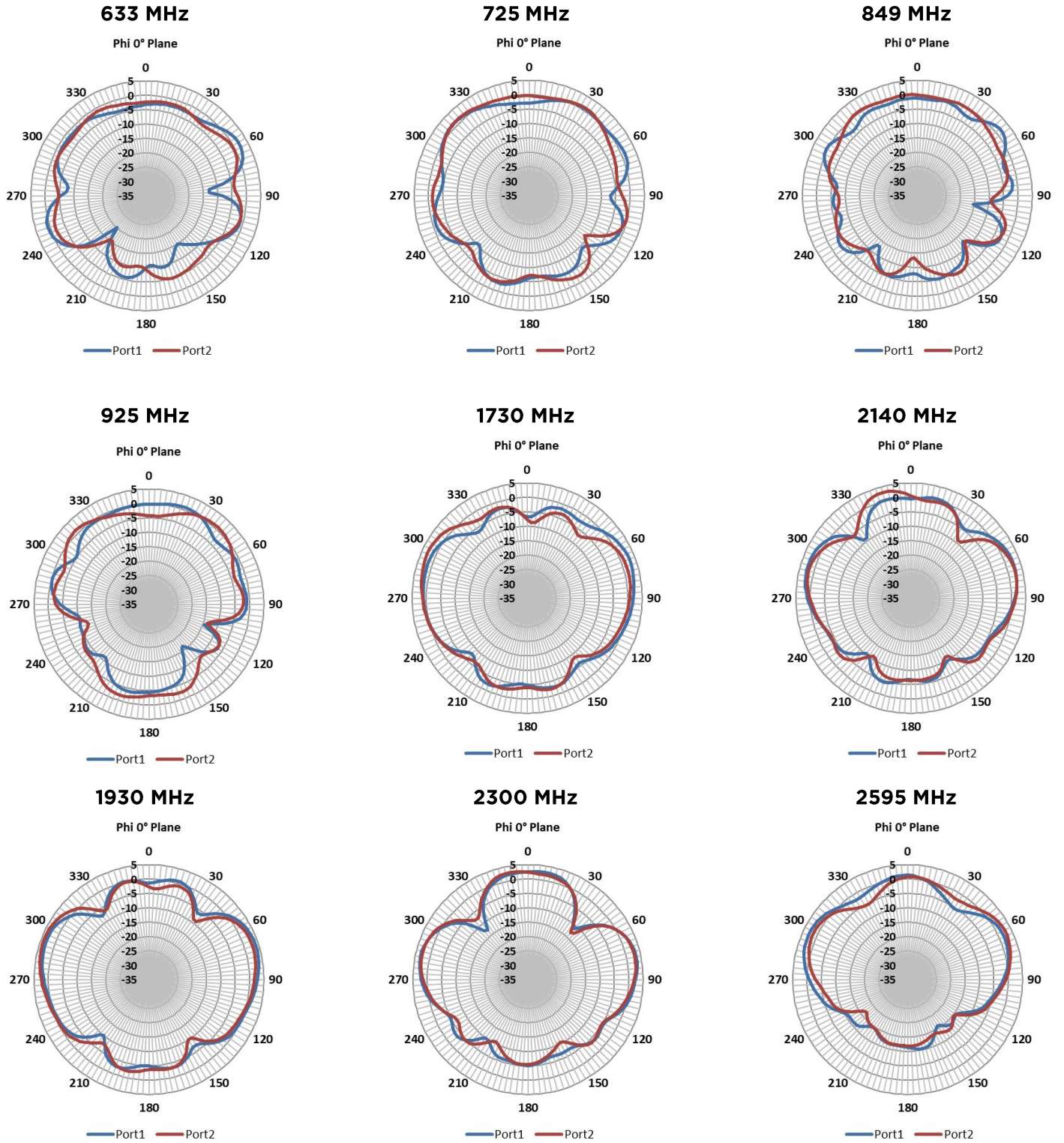

RADIATION PATTERNS

Elevation Plane 90° - Phi 90°

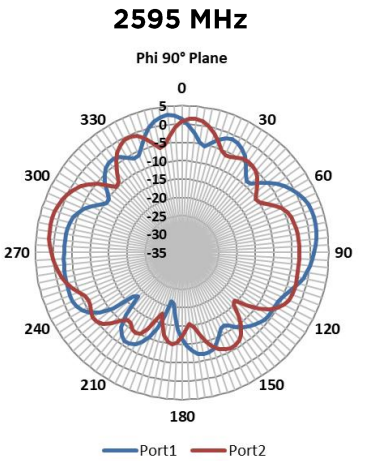
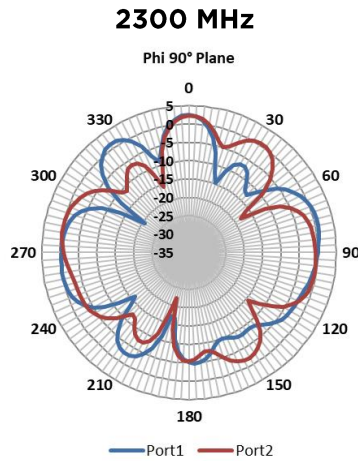
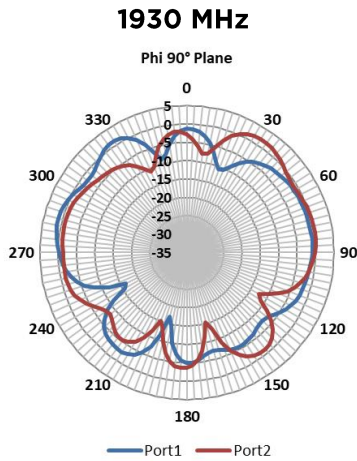
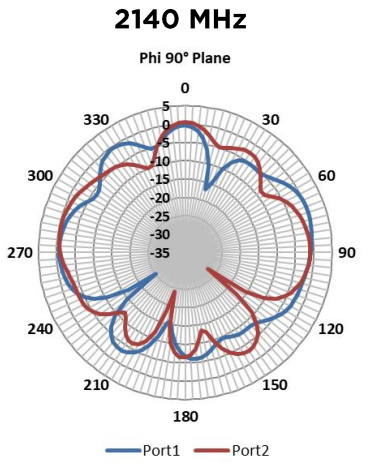
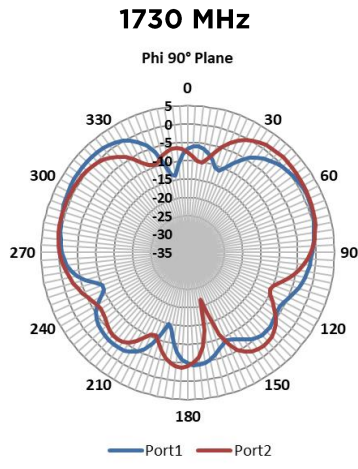
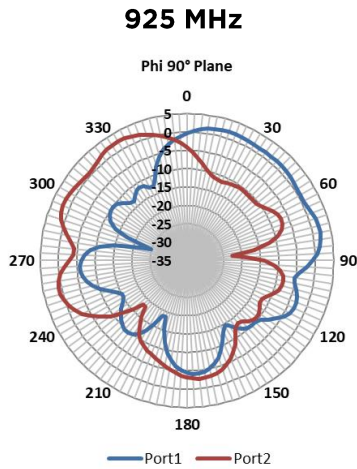
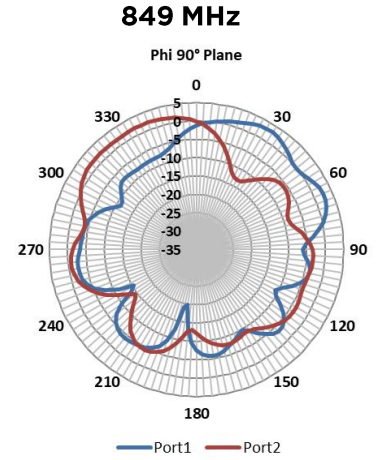
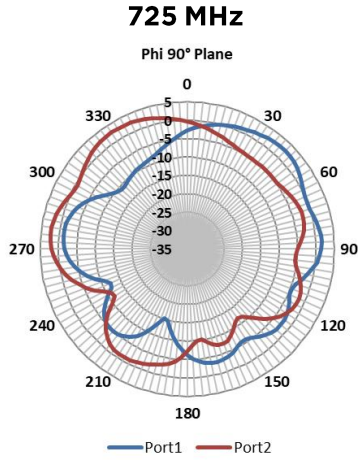
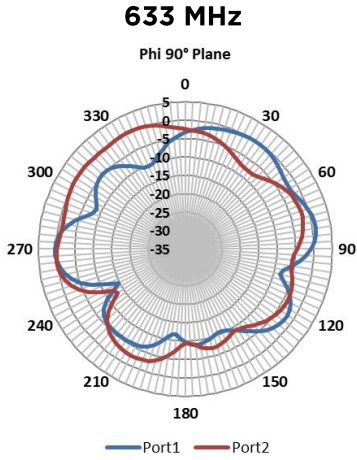

Laird warrants to the original end user customer of its products that its products are free from defects in material and workmanship. Subject to conditions and limitations Laird will, at its option, either repair or replace any part of its products that prove defective because of improper workmanship or materials. This limited warranty is in force for the useful lifetime of the original end product into which the Laird product is installed. Useful lifetime of the original end product may vary but is not to exceed five (5) years from the original date of the end product purchase.

Any information furnished by Laird Inc. and its agents is believed to be accurate and reliable. All specifications are subject to change without notice. Responsibility for the use and application of Laird materials rests with the end user, since Laird and its agents cannot be aware of all potential uses. Laird makes no warranties as to the fitness, merchantability or suitability of any Laird materials or products for any specific or general uses. Laird shall not be liable for incidental or consequential damages of any kind. All Laird products are sold pursuant to the Laird Terms and Conditions of sale in effect from time to time, a copy of which will be furnished upon request.

© Copyright 2019 Laird Inc. All Rights Reserved. Laird, Laird Technologies, the Laird Logo, and other marks are trademarks or registered trademarks of Laird Inc. or an affiliate company thereof. Other product or service names may be the property of third parties. Nothing herein provides a license under any Laird or any third party intellectual property rights.

sales@lairdconnect.com  
support@lairdconnect.com  
www.lairdconnect.com



## X-ON Electronics

Largest Supplier of Electrical and Electronic Components

*Click to view similar products for [Antennas](#) category:*

*Click to view products by [Laird Connectivity](#) manufacturer:*

Other Similar products are found below :

[GAN30084EU](#) [930-033-R](#) [GW17.07.0250E](#) [1513563-1](#) [EXE902SM](#) [APAMPG-117](#) [MAF94383](#) [W3908B0100](#) [W6102B0100](#) [YE572113-30RSMM](#) [108-00014-50](#) [66089-2406](#) [SPDA17RP918](#) [A09-F8NF-M](#) [A09-F5NF-M](#) [RGFRA1903041A1T](#) [W3593B0100](#) [W3921B0100](#) [SIMNA-868](#) [SIMNA-915](#) [SIMNA-433](#) [W1044](#) [W1049B090](#) [A75-001](#) [WTL2449CQ1-FRSMM](#) [CPL9C](#) [EXB148BN](#) [0600-00060](#) [TRA9020S3PBN-001](#) [Y4503](#) [GD5W-28P-NF](#) [MA9-7N](#) [GD53-25](#) [GD5W-21P-NF](#) [C37](#) [MAF94051](#) [MA9-5N](#) [EXD420PL](#) [B1322NR](#) [QWFTB120](#) [MAF94271](#) [MAF94300](#) [GPSMB301](#) [FG4403](#) [AO-AGSM-OM54](#) [5200232](#) [MIKROE-2349](#) [WCM.01.0111](#) [MIKROE-2393](#) [MIKROE-2352](#)