

**OptoTEC™ OTX Series Thermoelectric Cooler**

The OTX20-66-F0-1211-11-W2.25 is a high-performance, miniature thermoelectric cooler. The OTX20-66-F0-1211-11-W2.25 is primarily used in applications to stabilize the temperature of sensitive optical components in the telecom and photonics industries. It has a maximum  $Q_c$  of 9.2 Watts when  $\Delta T = 0$  and a maximum  $\Delta T$  of 72.9 °C at  $Q_c = 0$ .

**Features**

- Miniature footprint
- Precise temperature control
- Reliable solid-state operation
- No sound or vibration
- RoHS-compliant

**Applications**

- Laser Diodes
- Optical Transceivers
- Lidar Sensors
- Infrared Range (IR) Sensors
- CMOS Sensors
- Autonomous Systems
- Machine Vision
- Security Cameras

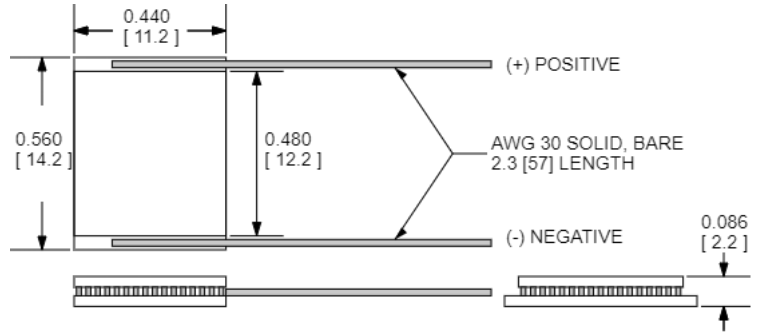

CERAMIC MATERIAL: Al<sub>2</sub>O<sub>3</sub>  
 SOLDER CONSTRUCTION: 232°C, SbSn

INCHES [MM]

**ELECTRICAL AND THERMAL PERFORMANCE**

Heat Pumped at Cold Side  
 $T_{hot} = 27\text{ °C}$

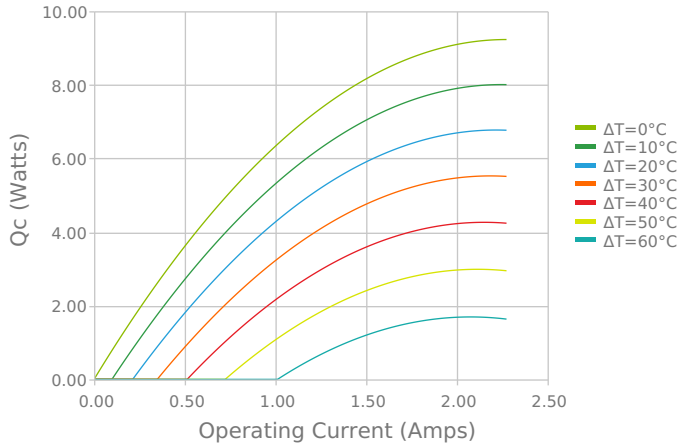

Heat Pumped at Cold Side  
 $T_{hot} = 27\text{ °C}$

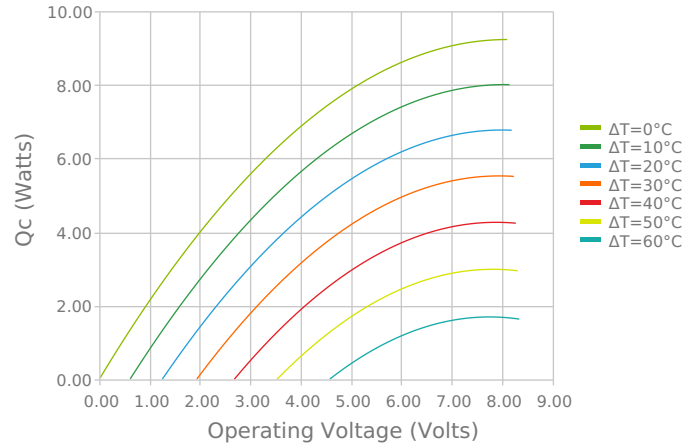

Current vs Voltage (I vs V)  
 $T_{hot} = 27\text{ °C}$

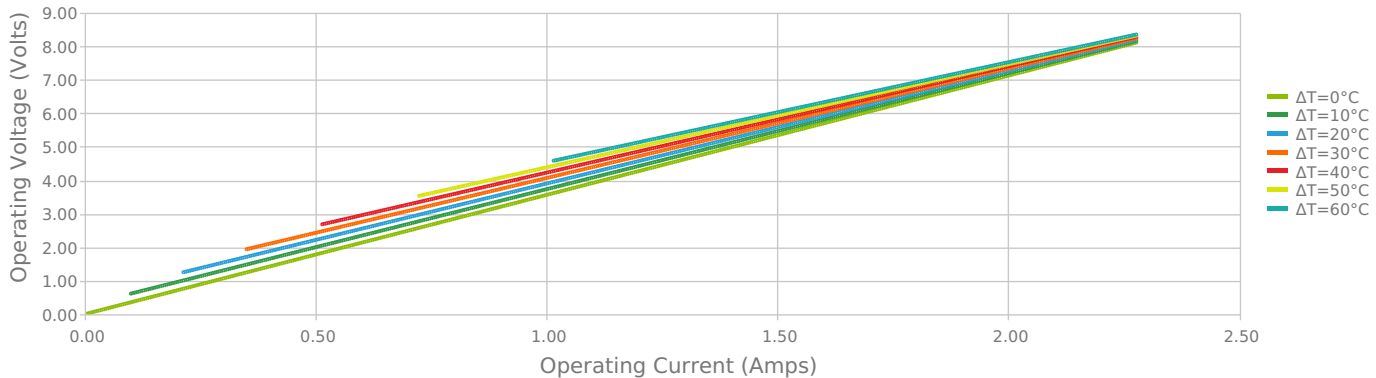

Coefficient of Performance (COP = Qc/Pin)  
 Thot = 27 °C

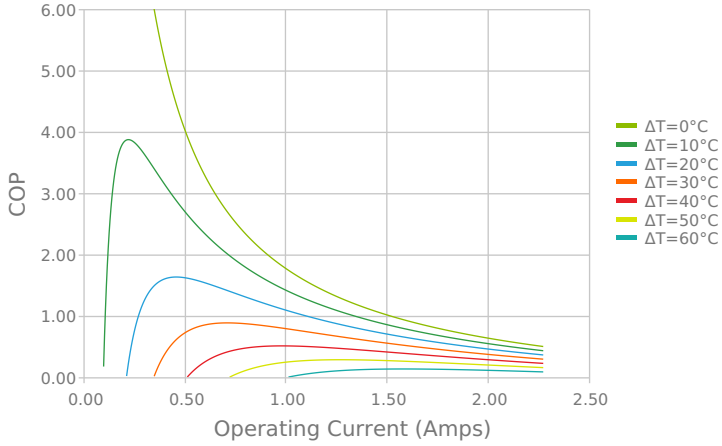

Coefficient of Performance (COP = Qc/Pin)  
 Thot = 27 °C

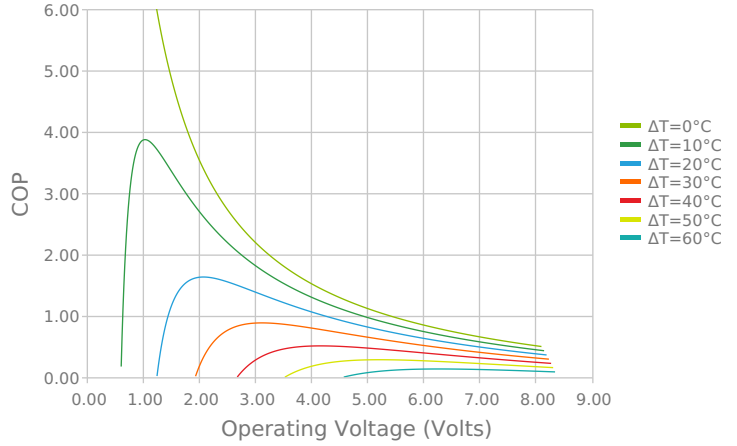

Total Heat Dissipated at Hot Side (Qh=Qc+Pin)  
 Thot = 27 °C

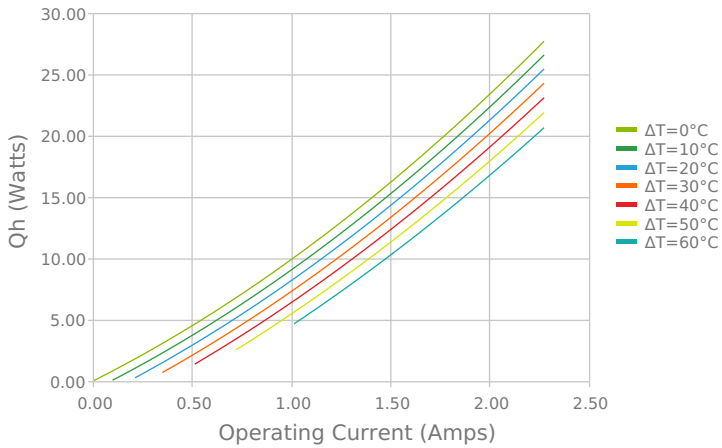

Total Heat Dissipated at Hot Side (Qh=Qc+Pin)  
 Thot = 27 °C

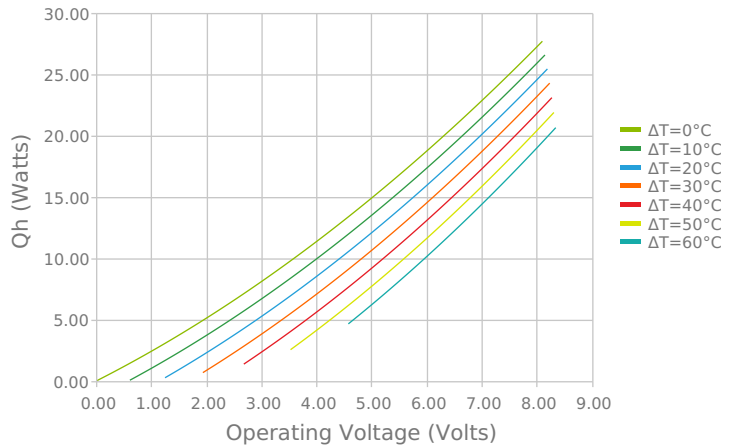

Heat Pumped at Cold Side (Qc)  
 Thot = 27 °C | Current = 1.7 Amps

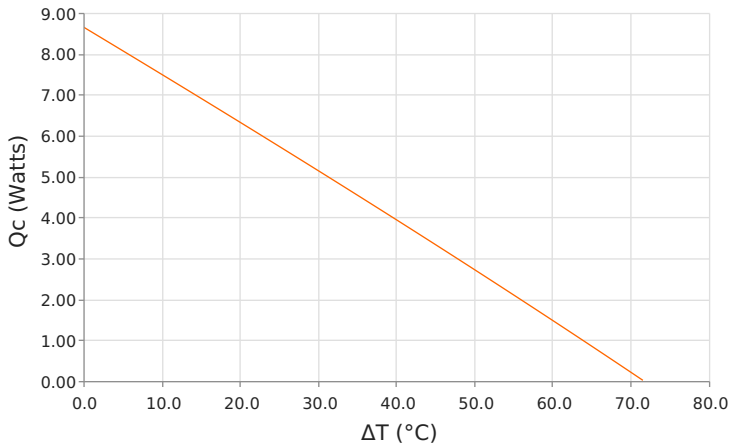

Coefficient of Performance (COP = Qc/Pin)  
 Thot = 27 °C | Current = 1.7 Amps

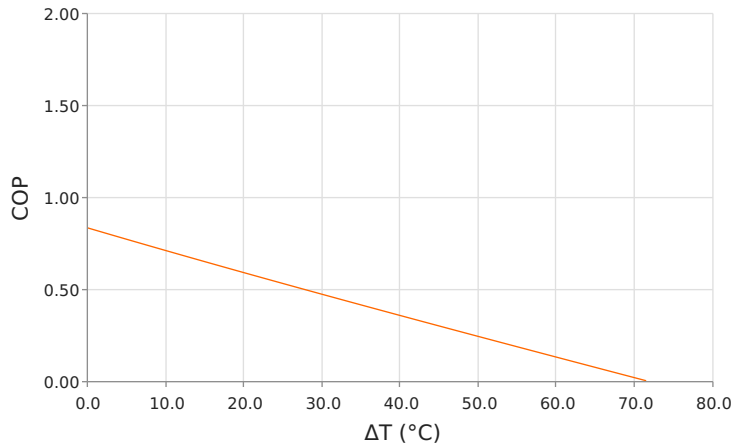

## SPECIFICATIONS\*

Hot Side Temperature	27.0 °C	50.0 °C	80.0 °C
<b>Qcmax (<math>\Delta T = 0</math>)</b>	9.2 Watts	9.9 Watts	10.7 Watts
<b><math>\Delta T_{max}</math> (<math>Q_c = 0</math>)</b>	72.9°C	81.8°C	92.1°C
<b>I<sub>max</sub> (I @ <math>\Delta T_{max}</math>)</b>	2.0 Amps	2.0 Amps	1.9 Amps
<b>V<sub>max</sub> (V @ <math>\Delta T_{max}</math>)</b>	7.7 Volts	8.5 Volts	9.6 Volts
<b>Module Resistance</b>	3.56 Ohms	4.01 Ohms	4.58 Ohms
<b>Max Operating Temperature</b>	120 °C		
<b>Weight</b>	2.0 gram(s)		

\* Specifications reflect thermoelectric coefficients updated March 2020

## FINISHING OPTIONS

Suffix	Thickness	Flatness / Parallelism	Hot Face	Cold Face	Lead Length
11	2.184 ±0.127 mm 0.086 ± 0.0050 in	0.051 mm / 0.051 mm 0.002 in / 0.002 in	Lapped	Lapped	50.8 mm 2.00 in

## SEALING OPTIONS

Suffix	Sealant	Color	Temp Range	Description
	None			No sealing specified

## NOTES

1. Max operating temperature: 120°C
2. Do not exceed I<sub>max</sub> or V<sub>max</sub> when operating module
3. Reference assembly guidelines for recommended installation
4. Solder tinning also available on metallized ceramics

Any information furnished by Laird and its agents, whether in specifications, data sheets, product catalogues or otherwise, is believed to be (but is not warranted as being) accurate and reliable, is provided for information only and does not form part of any contract with Laird. All specifications are subject to change without notice. Laird assumes no responsibility and disclaims all liability for losses or damages resulting from use of or reliance on this information. All Laird products are sold subject to the Laird Terms and Conditions of sale (including Laird's limited warranty) in effect from time to time, a copy of which will be furnished upon request.

© Copyright 2019-2021 Laird Thermal Systems, Inc. All rights reserved. Laird™, the Laird Ring Logo, and Laird Thermal Systems™ are trademarks or registered trademarks of Laird Limited or its subsidiaries.

OptoTEC™ is a trademark of Laird Thermal Systems, Inc. All other marks are owned by their respective owners.

Date: 12/15/2021

## X-ON Electronics

Largest Supplier of Electrical and Electronic Components

*Click to view similar products for [Thermoelectric Peltier Modules](#) category:*

*Click to view products by [Laird Thermal Systems](#) manufacturer:*

Other Similar products are found below :

[C3100-1980](#) [C3200-0504](#) [C3200-0505](#) [C3200-371](#) [C3400-0262](#) [430084-505](#) [C3400-215](#) [DAC046-24-02-00-00](#) [430866-501](#) [CP39136H](#)  
[CP35447](#) [CP85204035](#) [CP60131H](#) [CPM-2F](#) [CP853345H](#) [CP85138](#) [CP35347](#) [430077-523](#) [CP081030-M](#) [CP12437](#) [CP30138H](#) [CP30338](#)  
[CP303385H](#) [CP35247](#) [CP39236H](#) [CP393365H](#) [CP40236](#) [CP40247](#) [CP40347](#) [CP50441](#) [CP60231H](#) [CP60233](#) [CP60239H](#) [CP60240](#)  
[CP60301540](#) [CP60333](#) [CP603395H](#) [CP60340](#) [CP604395H](#) [CP60440](#) [CP70437](#) [CP854345H](#) [CP854705-2](#) [CP10205033](#) [CP10304033](#)  
[CP1054033H](#) [CP115035335](#) [CP144745325](#) [CP200543636](#) [CP2020405H](#)