



DB151S THRU DB157S

VOLTAGE RANGE	50 to 1000 Volts
CURRENT	1.5 Ampere



Features

- Glass passivated chip
- Low forward voltage drop
- Low leakage current
- High forward surge capability
- High temperature soldering: 260°C/10S at terminals
- Component in accordance to ROHS 2002/95/1 and WEEE 2002/96/EC

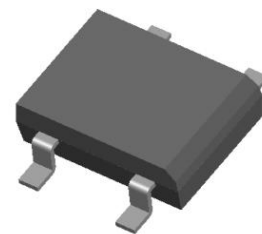

Mechanical Data

- Case: Molded plastic body
- Molding compound meets UL 94 V-0 flammability rating, Halogen-free, RoHS-compliant, and commercial grade
- Polarity: Molded on body
- Weight: 0.02 ounce, 0.40 grams

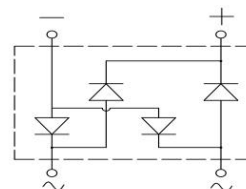

Maximum Ratings and Electrical Characteristics

- Ratings at 25°C ambient temperature unless otherwise specified
- Single Phase, half wave, 60Hz, resistive or inductive load
- For capacitive load derate current by 20%

TYPE NUMBER	SYMBOL	DB 151S	DB 152S	DB 153S	DB 154S	DB 155S	DB 156S	DB 157S	UNITS
Maximum Repetitive Peak Reverse Voltage	V_{RRM}	50	100	200	400	600	800	1000	Volts
Maximum RMS Voltage	V_{RMS}	35	70	140	280	420	560	700	Volts
Maximum DC Blocking Voltage	V_{DC}	50	100	200	400	600	800	1000	Volts
Maximum Average Forward Rectified Current $T_L=100^\circ\text{C}$	$I_{(AV)}$	1.5							Amp
Peak Forward Surge Current 8.3mS single half sine wave superimposed on rated load (JEDEC method)	I_{FSM}	50							Amps
Maximum Instantaneous Forward Voltage @ 1.5A	V_F	1.1							Volts
Current squared time @ $1\text{ms} \leq t \leq 8.3\text{ms}$ $T_J=25^\circ\text{C}$, Rating of per diode	I^2t	15							A^2s
Maximum DC Reverse Current at Rated DC Blocking Voltage	$T_A = 25^\circ\text{C}$	5.0							μA
	$T_A = 125^\circ\text{C}$	100							
Typical Junction Capacitance ^(Note 1)	C_J	30							pF
Typical Thermal Resistance ^(Note 2)	$R_{\theta JA}$	26							$^\circ\text{C}/\text{W}$
	$R_{\theta JL}$	65							
Operating Junction Temperature Range	T_J, T_{STG}	(-55 to +150)							$^\circ\text{C}$

Notes:

1. Measured at 1.0MHz and applied reverse voltage of 4.0 Volts.
2. Thermal Resistance test performed in accordance with JESD-51. Unit mounted on 15mm*12mm*1.6mm AL pad attach 195mm*110mm*10mm steel plate.
3. The typical data above is for reference only.



DB151S THRU DB157S

VOLTAGE RANGE 50 to 1000 Volts
CURRENT 1.5 Ampere

Ratings and Characteristic Curves ($T_A=25^\circ\text{C}$ unless otherwise noted)

F1G.1-FORWARD CURRENT DERATING CURVE

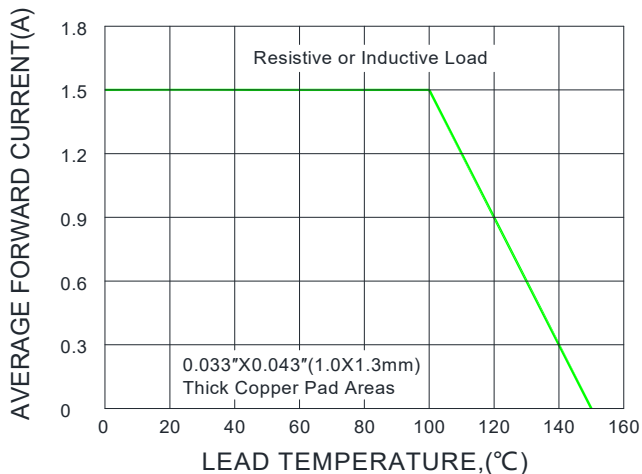

F1G.2-MAXIMUM NON-REPETITIVE PEAK FORWARD SURGE CURRENT

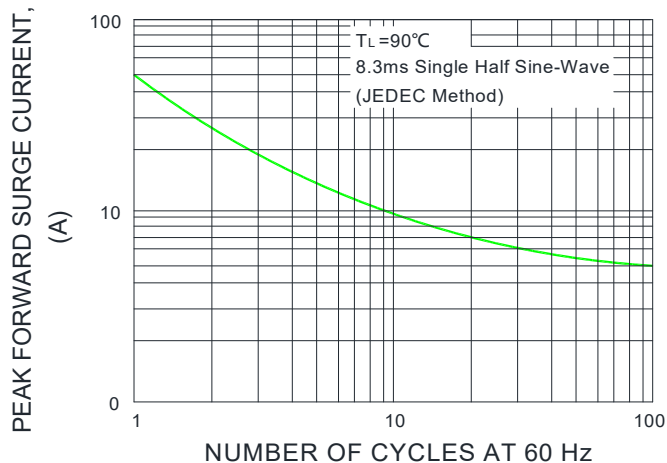

F1G.3-TYPICAL INSTANTANEOUS FORWARD CHARACTERISTICS

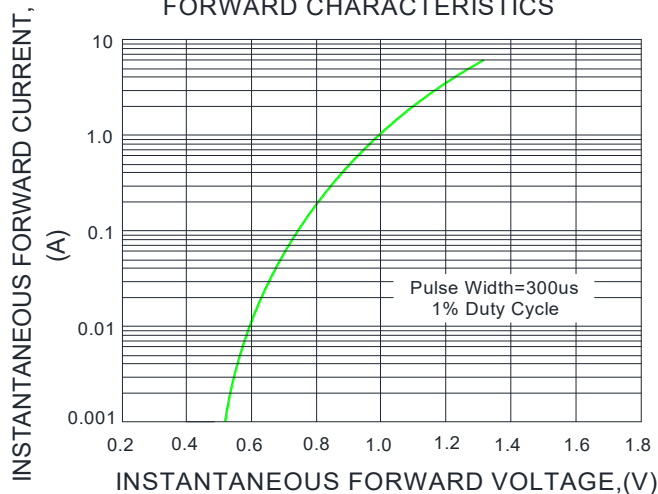

F1G.4-TYPICAL REVERSE CHARACTERISTICS

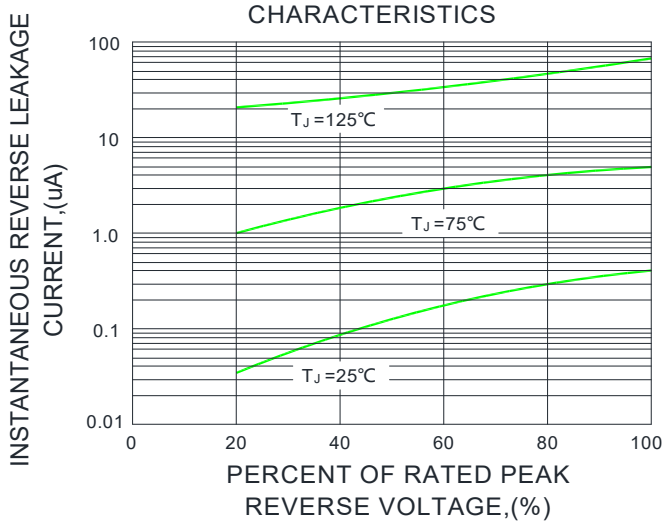

F1G.5-TYPICAL JUNCTION CAPACITANCE

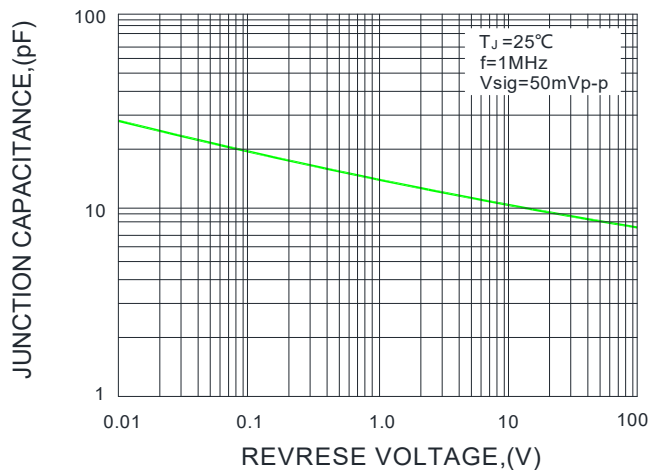



DB151S THRU DB157S

VOLTAGE RANGE

50 to 1000 Volts

CURRENT

1.5 Ampere

Package Outline Dimensions in inches (millimeters)

- Outline Dimensions

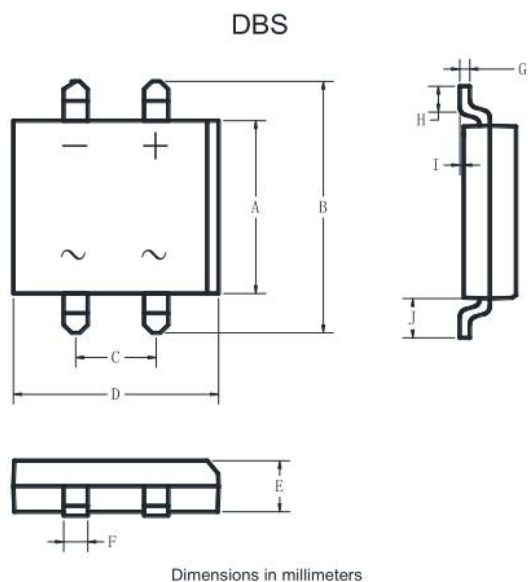

Dim	mm		in	
	min	max	min	max
A	6.20	6.50	.244	.256
B	9.60	10.30	.378	.406
C	5.00	5.20	.197	.205
D	8.13	8.51	.320	.335
E	2.38	2.45	.093	.096
F	0.98	1.13	.038	.044
G	0.18	0.23	.007	.009
H	1.02	1.53	.040	.060
I	0.05	0.20	.001	.007
J	1.80	2.10	.070	.082

- Suggested pad layout

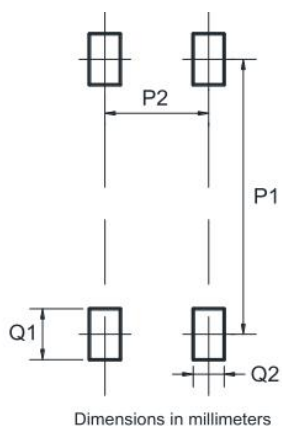

Dim	Min
P1	8.73
P2	5.12
Q1	2.22
Q2	1.2



DB151S THRU DB157S

VOLTAGE RANGE 50 to 1000 Volts
CURRENT 1.5 Ampere

Packing Requirments

- PS black anti-static carrier tape packing

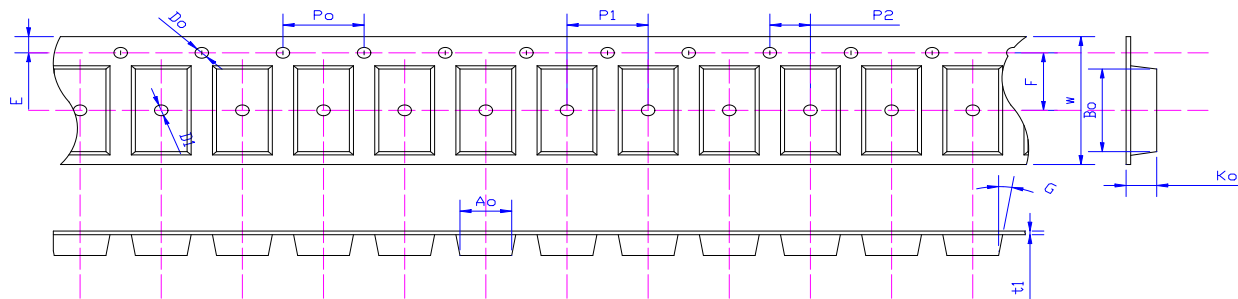

Specifications	Ao	Bo	Ko	Po	W	t1
DBS	8.64±0.10	9.85±0.10	2.60±0.10	4.00±0.1	16.0±0.10	0.30±0.02

- 13 "antistatic plastic reel

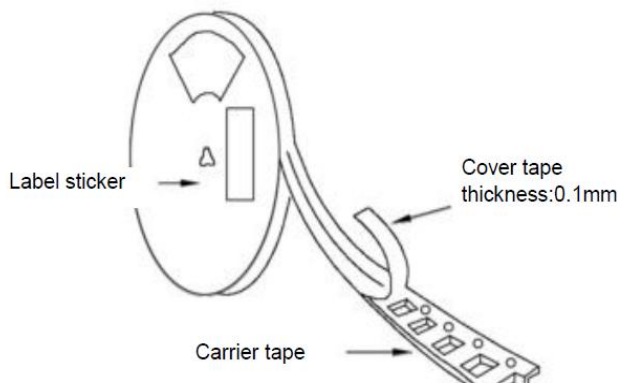

DEVICE TYPE	13" Reel			
	Q'TY/REEL(pcs)	REEL/BOX	BOX/CARTOON	Q'TY/CARTON(pcs)
DBS	3000	2	8	48000



Reflow Profile

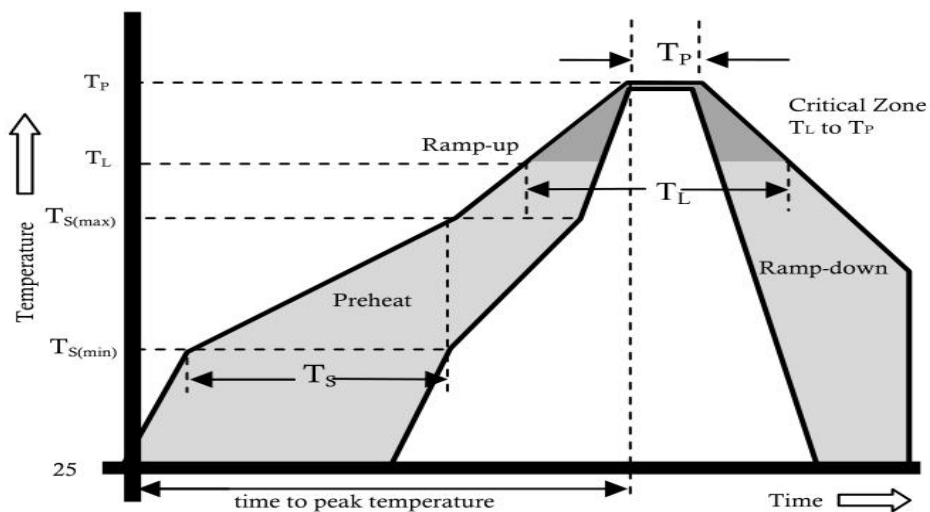

Reflow Condition		Pb-Free Assembly
Pre Heat	Temperature Min.	+150°C
	Temperature Max.	+200°C
	Time(Min to Max)	60-180 secs.
Average ramp up rate(Liquidus Temp(T_L) to peak)		3°C/sec. Max.
$T_{S(max)}$ to T_L - Ramp-up Rate		3°C/sec. Max.
Reflow	Temperature (T_L)(Liquidus)	+217°C
	Temperature (T_P)	60-150 secs.
Peak Temp (T_P)		+(260+0/-5)°C
Time within 5°C of actual Peak Temp (T_P)		25 secs.
Ramp-down Rate		6°C/sec. Max.
Time 25°C to peak Temp (T_P)		8 min. Max.
Do not exceed		+260°C



DB151S THRU DB157S

VOLTAGE RANGE 50 to 1000 Volts
CURRENT 1.5 Ampere

Disclaimer

The information presented in this document is for reference only. Chongqing changjie Electronic Technology Co., Ltd. reserves the right to make changes without notice for the specification of the products displayed herein to improve reliability, function or design or otherwise.

The product listed herein is designed to be used with ordinary electronic equipment or devices, and not designed to be used with equipment or devices which require high level of reliability and the malfunction of which would directly endanger human life (such as medical instruments, transportation equipment, aerospace machinery, nuclear-reactor controllers, fuel controllers and other safety devices), Changjie or anyone on its behalf, assumes no responsibility or liability for any damages resulting from such improper use of sale.

This publication supersedes & replaces all information previously supplied. For additional information, please visit our website [http:// www.czlangjie.com](http://www.czlangjie.com) , or consult your nearest Langjie's sales office for further assistance.

X-ON Electronics

Largest Supplier of Electrical and Electronic Components

Click to view similar products for [Bridge Rectifiers](#) category:

Click to view products by [LangJie](#) manufacturer:

Other Similar products are found below :

[MB252](#) [MB356G](#) [MB358G](#) [GBJ1504-BP](#) [GBU10B-BP](#) [GBU15K-BP](#) [GBU4A-BP](#) [GBU4D-BP](#) [DB101-BP](#) [DF01](#) [DF10SA-E345](#) [KBPC50-10S](#) [RS405GL-BP](#) [GBJ1502-BP](#) [GBU6M](#) [TB102M](#) [MB1510](#) [MB86](#) [TL401G](#) [MDA920A2](#) [TU602](#) [TU810](#) [MP5010W-BP](#) [MP501W-BP](#) [MP502-BP](#) [KBPC25-02](#) [VBO160-12NO7](#) [VS-110MT120KPBF](#) [VS-60MT80KPBF](#) [DB105-BP](#) [DF1510S](#) [VS-40MT160PAPBF](#) [GBU4G-BP](#) [GSIB15A80-E3/45](#) [DB104-BP](#) [D3SB60](#) [TB354](#) [GBJ2504-BP](#) [26MB100A](#) [B1S-G](#) [VS-40MT160KPBF](#) [VUO162-16NO7](#) [ABS10-G](#) [GBU6B-BP](#) [GBJ1508-BP](#) [BR5010-G](#) [ABS6-G](#) [B125C800G-E4/51](#) [MSB15MH-13](#) [LBS10-13](#)