



HER101 THRU HER108

VOLTAGE RANGE 50 to 1000 Volts
CURRENT 1.0 Ampere

Features

- High speed switching
- Low forward voltage drop
- Low leakage current
- High forward surge capability
- High reliability
- High temperature soldering guaranteed
260°C/10 seconds, 0.375"(9.5mm) lead length at 5 lbs(2.3kg) tension

Mechanical Data

- Case: Transfer molded plastic
- Epoxy: UL94V-0 rate flame retardant
- Polarity: Color band denotes cathode end
- Lead: Plated axial lead, solderable per MIL-STD-202E method 208C
- Mounting position: Any
- Weight: 0.012ounce, 0.33 grams

DO-41

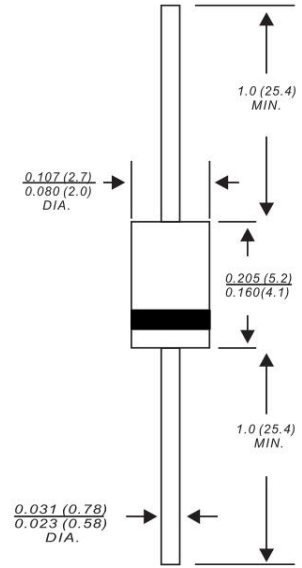

Dimensions in inches and (millimeters)

Maximum Ratings and Electrical Characteristics

- Ratings at 25°C ambient temperature unless otherwise specified
- Single Phase, half wave, 60Hz, resistive or inductive load
- For capacitive load derate current by 20%

TYPE NUMBER	SYMBOL S	HER 101	HER 102	HER 103	HER 104	HER 105	HER 106	HER 107	HER 108	UNIT S
Maximum Repetitive Peak Reverse Voltage	V _{RRM}	50	100	200	300	400	600	800	1000	Volts
Maximum RMS Voltage	V _{RMS}	35	70	140	210	280	420	560	700	Volts
Maximum DC Blocking Voltage	V _{DC}	50	100	200	300	400	600	800	1000	Volts
Maximum Average Forward Rectified Current at T _A =75°C	I _(AV)	1.0								Amps
Peak Forward Surge Current 8.3mS single half sine-wave superimposed on rated load (JEDEC method)	I _{FSM}	30								Amps
Maximum Instantaneous Forward Voltage at 1.0A	V _F	1.0		1.3		1.5		1.7		Volts
Maximum DC Reverse Current at Rated DC Blocking Voltage	T _A = 25°C	5.0								µA
	T _A = 100°C	100								
Maximum Reverse Recovery Time(NOTE1)	T _{RR}	50				75				nS
Typical Junction Capacitance (NOTE 2)	C _J	15				12				pF
Typical Thermal Resistance (NOTE 3)	R _{θJA}	60								°C/W
Operating and Storage Temperature Range	T _J , T _{STG}	-55 to +150								°C

Notes:

1. Reverse Recovery Test Conditions: I_f=0.5A, I_r=1.0A, I_{rr}=0.25A.
2. Measured at 1.0MHz and applied reverse voltage of 4.0 Volts.
3. Thermal Resistance from Junction to Ambient with 0.375"(9.5mm) lead length, PCB mounted.



AXIAL HIGH EFFICIENCY RECTIFIER

HER101 THRU HER108

VOLTAGE RANGE

50 to 1000 Volts

CURRENT

1.0 Ampere

Ratings and Characteristic Curves ($T_A=25^\circ\text{C}$ unless otherwise noted)

FIG.1-TYPICAL FORWARD CURRENT DERATING CURVE

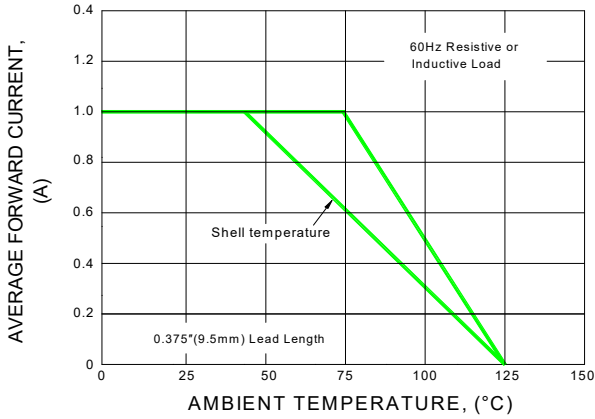

FIG.2-MAXIMUM NON-REPETITIVE PEAK FORWARD SURGE CURRENT

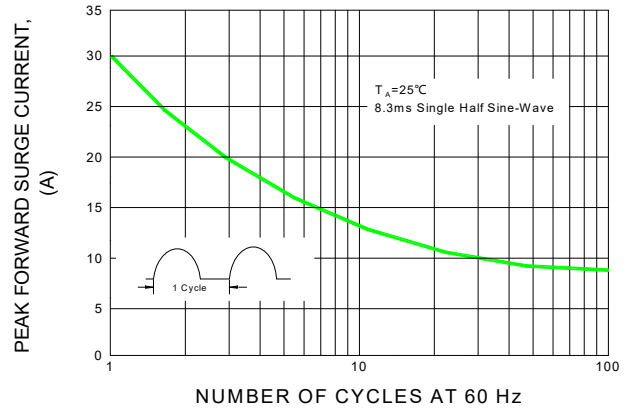

FIG.3-TYPICAL INSTANTANEOUS FORWARD CHARACTERISTICS

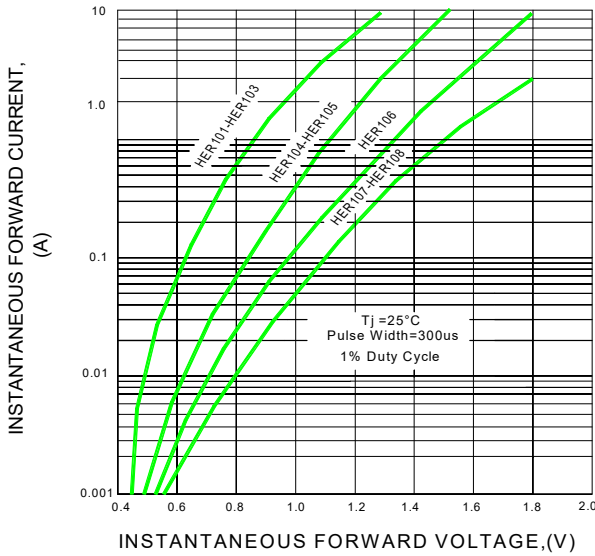

FIG.3-TYPICAL REVERSE CHARACTERISTICS

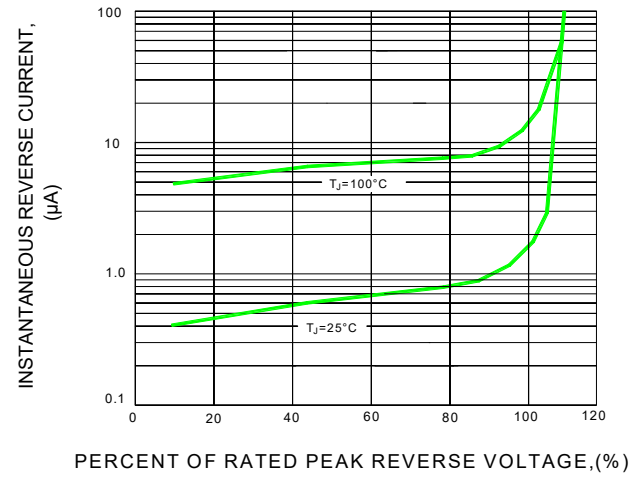

FIG.5-TYPICAL JUNCTION CAPACITANCE

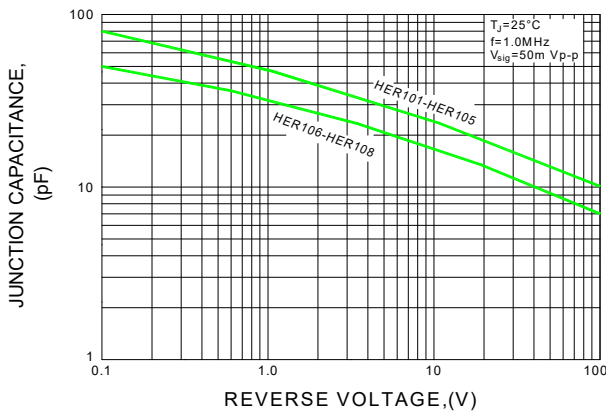
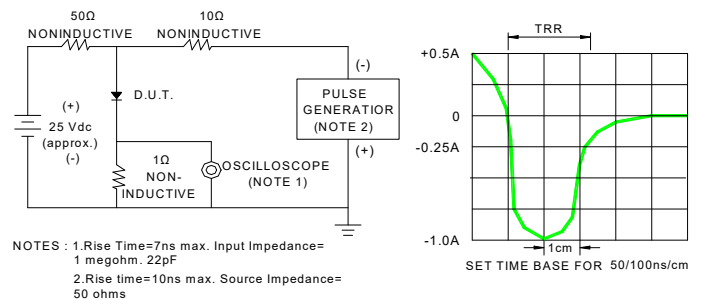
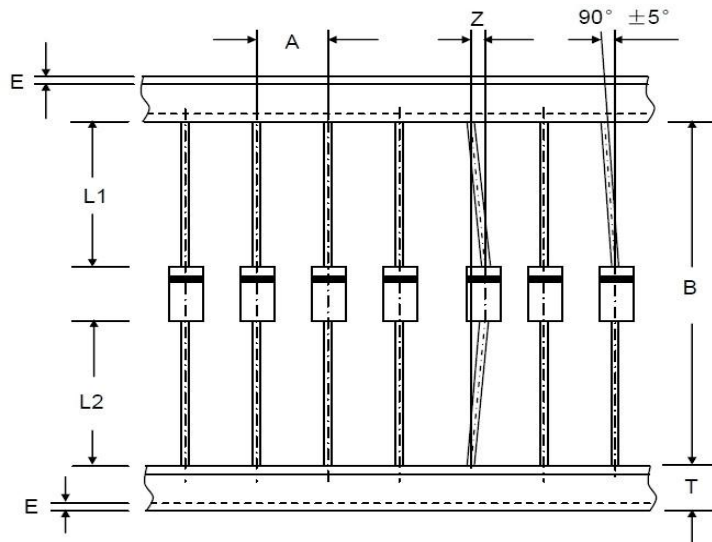

FIG.6-TEST CIRCUIT DIAGRAM AND FORWARD SURGE CURRENT





Axial Lead Taping Specifications for Rectifiers



Component Outline	Component Pitch A	Inner Tape Pitch B		Cumulative Tolerance
	±0.5mm	+0.5mm	-0.4mm	
DO-204AL(DO-41)	5.0mm	52.4mm	26.0mm	2.0mm/20pitch

Item	Symbol	Specifications(mm)	Specifications(inch)
Component alignment	Z	1.2 max	0.048 max
Tape width	T	6.0±0.4	0.236±0.016
Exposed adhesive	E	0.8 max	0.032 max
Body eccentricity	L1-L2	1.0 max	0.040 max



Reflow Profile

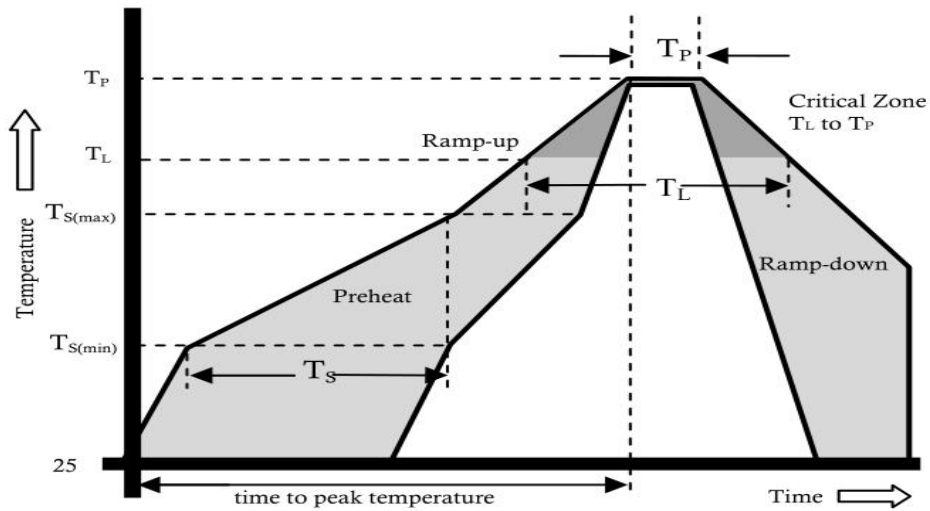

Reflow Condition		Pb-Free Assembly
Pre Heat	Temperature Min.	+150°C
	Temperature Max.	+200°C
	Time(Min to Max)	60-180 secs.
Average ramp up rate(Liquidus Temp(T_L) to peak)		3°C/sec. Max.
$T_{S(max)}$ to T_L - Ramp-up Rate		3°C/sec. Max.
Reflow	Temperature (T_L)(Liquidus)	+217°C
	Temperature (T_L)	60-150 secs.
Peak Temp (T_P)		+(260±0/-5) °C
Time within 5°C of actual Peak Temp (T_P)		25 secs.
Ramp-down Rate		6°C/sec. Max.
Time 25°C to peak Temp (T_P)		8 min. Max.
Do not exceed		+260°C



Disclaimer

The information presented in this document is for reference only. Chongqing changjie Electronic Technology Co., Ltd. reserves the right to make changes without notice for the specification of the products displayed herein to improve reliability, function or design or otherwise.

The product listed herein is designed to be used with ordinary electronic equipment or devices, and not designed to be used with equipment or devices which require high level of reliability and the malfunction of with would directly endanger human life (such as medical instruments, transportation equipment, aerospace machinery, nuclear-reactor controllers, fuel controllers and other safety devices), Changjie or anyone on its behalf, assumes no responsibility or liability for any damages resulting from such improper use of sale.

This publication supersedes & replaces all information previously supplied. For additional information, please visit our website [http:// www.czlangjie.com](http://www.czlangjie.com) , or consult your nearest Langjie's sales office for further assistance.

X-ON Electronics

Largest Supplier of Electrical and Electronic Components

Click to view similar products for [Rectifiers](#) category:

Click to view products by [LangJie](#) manufacturer:

Other Similar products are found below :

[70HFR40](#) [FR105 R0](#) [RL252-TP](#) [1N5397](#) [1N4005-TR](#) [1N4007-BP](#) [UFS120Je3/TR13](#) [20ETS12S](#) [RRE02VS6SGTR](#) [MS306](#) [A1N5404G-G](#)
[CRF02\(T5L,TEMQ\)](#) [ACGRB207-HF](#) [CLH07\(TE16L,Q\)](#) [CLH03\(TE16L,Q\)](#) [1N5395-TP](#) [UES1302](#) [ACGRC307-HF](#) [ACEFC304-HF](#) [DZ-](#)
[1380](#) [85HFR60](#) [40HFR60](#) [70HF120](#) [85HFR80](#) [SCF7500](#) [SM100](#) [ACGRA4001-HF](#) [SKN70/08](#) [NTE5819](#) [NTE5827](#) [NTE5828](#) [NTE5911](#)
[NTE5915](#) [NTE6104](#) [NTE6163](#) [NTE6164](#) [NTE6165](#) [NTE6364](#) [TSD3G](#) [SET130312](#) [NRVUS110VT3G](#) [UES1106](#) [UES1306](#)
[NRVUS240VT3G](#) [D5FE60-5063](#) [R4000GPS-TP](#) [D4015L56TP](#) [UES1306HR2](#) [FX20K120](#) [D20XB60-7101](#)