



RS2A FTTHRU RS2MF

VOLTAGE RANGE 50 to 1000 Volts

CURRENT 2.0 Ampere



Features

- Fast recovery glass passivated chip
- Low forward voltage drop
- Low leakage current
- High forward surge capability
- High temperature soldering: 260°C/10S at terminals
- Component in accordance to ROHS 2002/95/1 and WEEE 2002/96/EC



Mechanical Data

- Case: JEDEC SMAFL mold plastic Body over glass passivated chip
- Terminals: Solder plated, solderable per J-STD-002B and JESD22-B102D
- Polarity: Laser band denote cathode band
- Weight: 0.00095ounce, 0.028grams

Maximum Ratings and Electrical Characteristics

- Ratings at 25°C ambient temperature unless otherwise specified
- Single phase, half wave, 60Hz, resistive or inductive load
- For capacitive load derate current by 20%

TYPE NUMBER	SYMBOL	RS 2AF	RS 2BF	RS 2DF	RS 2GF	RS 2JF	RS 2KF	RS 2MF	UNITS
Maximum Repetitive Peak Reverse Voltage	V_{RRM}	50	100	200	400	600	800	1000	Volts
Maximum RMS Voltage	V_{RMS}	35	70	140	280	420	560	700	Volts
Maximum DC Blocking Voltage	V_{DC}	50	100	200	400	600	800	1000	Volts
Maximum Average Forward Rectified Current $T_L=125^\circ\text{C}$	$I_{(AV)}$	2.0							Amp
Peak Forward Surge Current 8.3mS single half sine wave superimposed on rated load (JEDEC method)	I_{FSM}	50							Amps
Maximum Instantaneous Forward Voltage @ 2.0A	V_F	1.3							Volts
Maximum DC Reverse Current at Rated DC Blocking Voltage	$T_A = 25^\circ\text{C}$	5.0							μA
	$T_A = 125^\circ\text{C}$	100							
Maximum Reverse Recovery Time (Note 3) $T_J=25^\circ\text{C}$	T_{RR}	150			250	500		nS	
Typical Junction Capacitance (Note 1)	C_J	15							pF
Typical Thermal Resistance (Note 2)	$R_{\theta JA}$	60							$^\circ\text{C}/\text{W}$
Operating Junction Temperature Range	T_J	(-55 to +150)							$^\circ\text{C}$
Storage Temperature Range	T_{STG}	(-55 to +150)							$^\circ\text{C}$

Notes:

1. Thermal resistance from Junction to ambient and from junction to lead mounted on PCB. with 0.2×0.2"(5.0 × 5.0mm) copper pad areas.
2. Measured at 1.0MHz and applied reverse voltage of 4.0V
3. Reverse Recovery Test Conditions: $I_f=0.5\text{mA}$, $I_r=1.0\text{mA}$, $I_{rr}=0.25\text{A}$



Ratings and Characteristic Curves ($T_A=25^\circ\text{C}$ unless otherwise noted)

FIG.1-TYPICAL FORWARD CURRENT DERATING CURVE

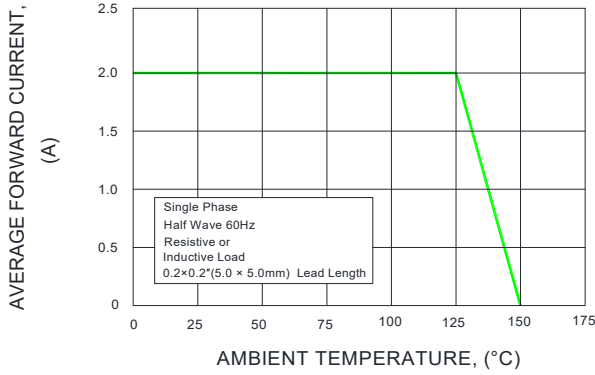

FIG.2-MAXIMUM NON-REPETITIVE PEAK FORWARD SURGE CURRENT

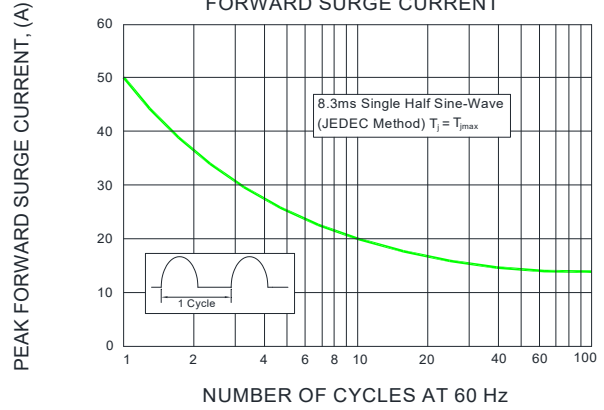

FIG.3-TYPICAL INSTANTANEOUS FORWARD CHARACTERISTICS

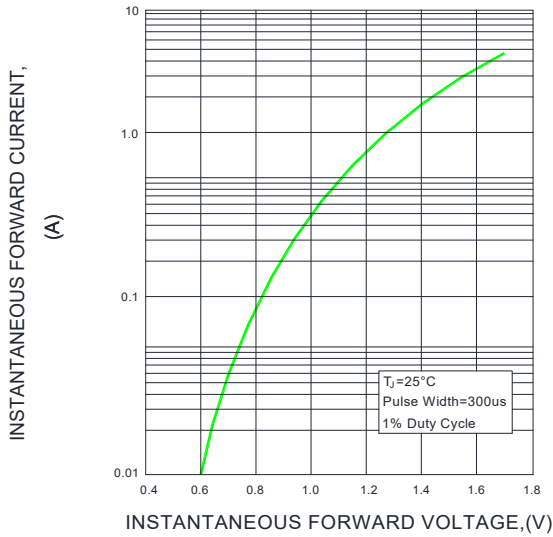

FIG.4-TYPICAL REVERSE CHARACTERISTICS

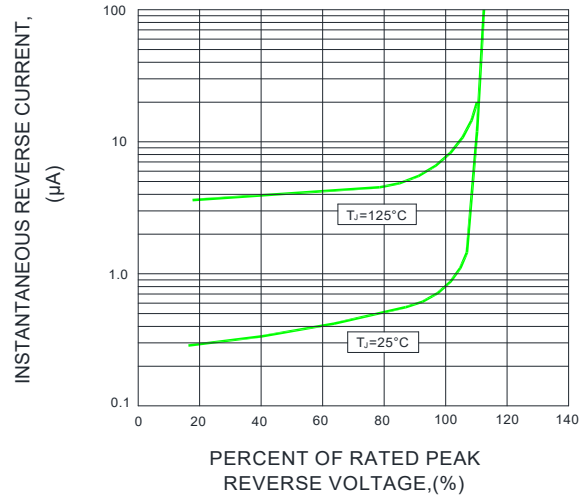

FIG.5-TYPICAL JUNCTION CAPACITANCE

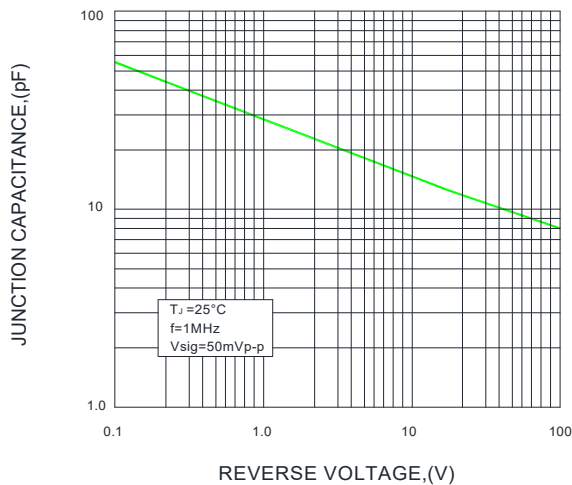
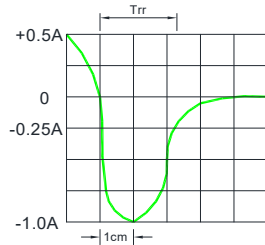
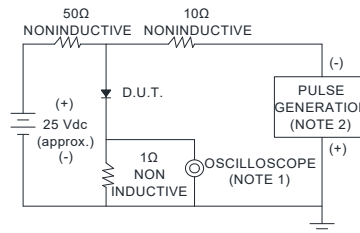

FIG.6-TEST CIRCUIT DIAGRAM AND REVERSE RECOVERY TIME CHARACTERISTIC



NOTES : 1.Rise Time=7ns max. Input Impedance= 1 magohm. 22pF
2.Rise time=10ns max. Source Impedance= 50 ohms

SET TIME BASE FOR 50/100ns/cm



Package Outline Dimensions in inches (millimeters)

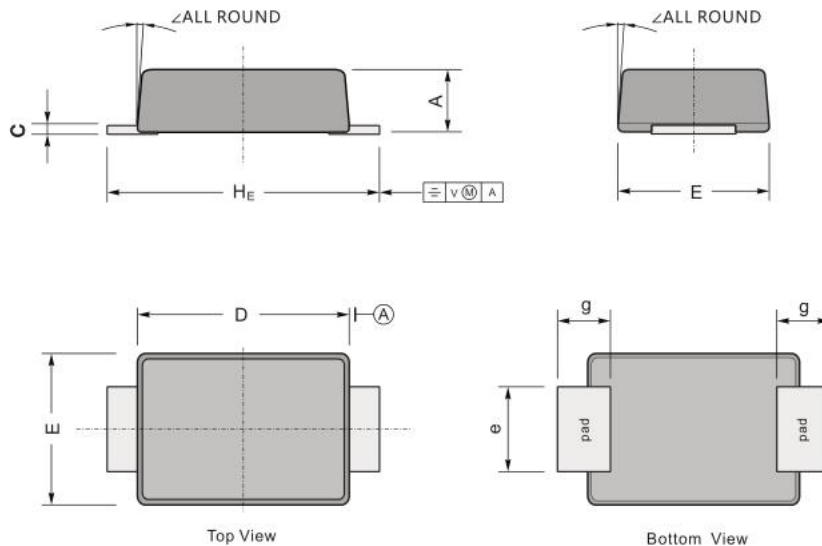

UNIT		A	C	D	E	e	g	H _E	∠
mm	max	1.10	0.20	3.70	2.70	1.60	1.20	4.90	5-7°
	min	0.90	0.12	3.30	2.40	1.30	0.80	4.40	
mil	max	43	7.90	146	106	63	47	193	
	min	35	4.70	130	94	51	31	173	

The Recommended Mounting Pad Size

Marking

Type number	Marking code
RS2AF	RS2A
RS2BF	RS2B
RS2DF	RS2D
RS2GF	RS2G
RS2JF	RS2J
RS2KF	RS2K
RS2MF	RS2M

The recommended mounting pad size

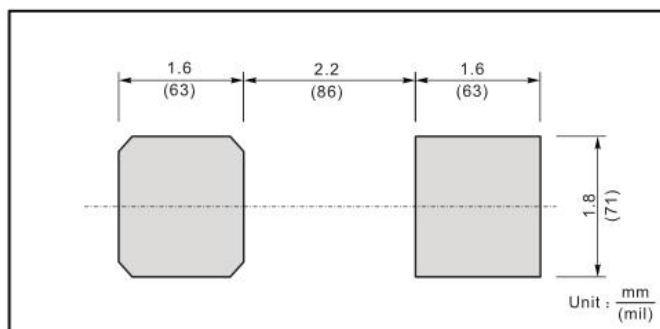



Packing Requirments

- PS black anti-static carrier tape packing

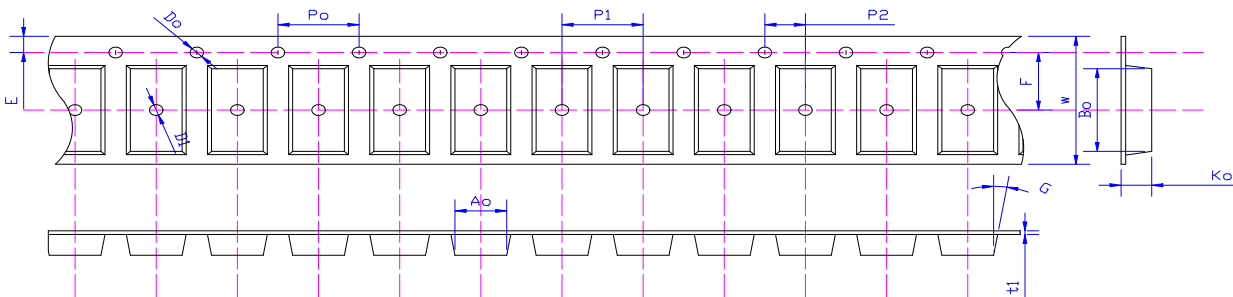

Specifications	Ao	Bo	Ko	Po	W	t1
SMAFL	2.83±0.10	4.90±0.10	1.45±0.10	4.00±0.1	12.0±0.05	0.23±0.02

- 13 "antistatic plastic reel

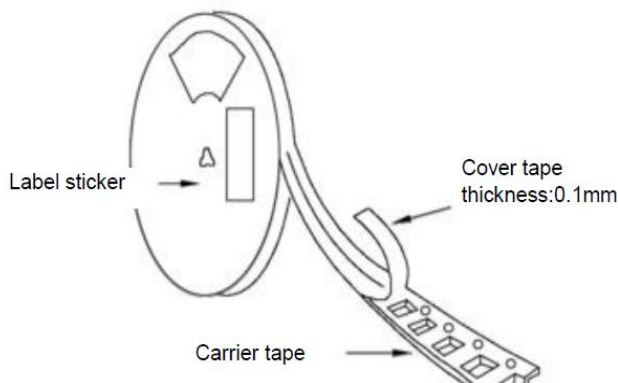

DEVICE TYPE	13" Reel			
	Q'TY/REEL(pcs)	REEL/BOX	BOX/CARTOON	Q'TY/CARTON(pcs)
SMAFL	10000	2	8	160000



Reflow Profile

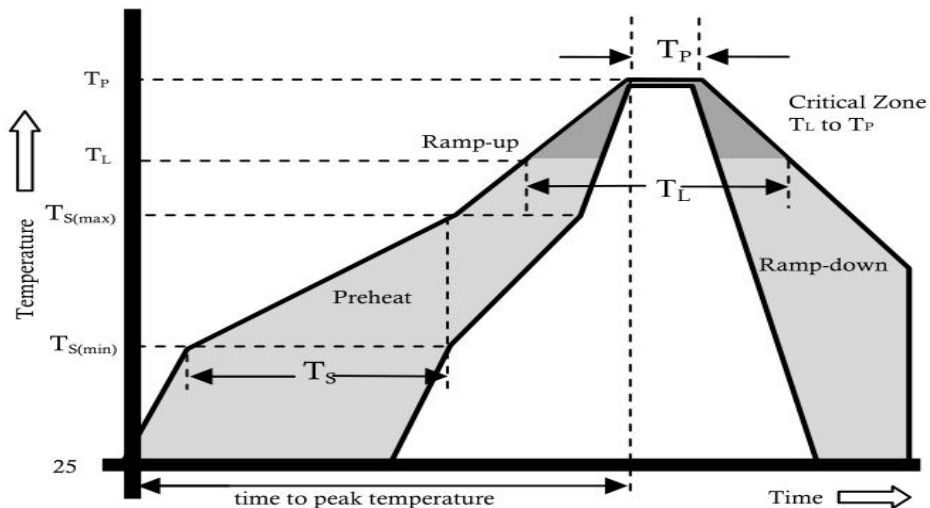

Reflow Condition		Pb-Free Assembly
Pre Heat	Temperature Min.	+150°C
	Temperature Max.	+200°C
	Time(Min to Max)	60-180 secs.
Average ramp up rate(Liquidus Temp(T_L) to peak)		3°C/sec. Max.
$T_{S(max)}$ to T_L - Ramp-up Rate		3°C/sec. Max.
Reflow	Temperature (T_L)(Liquidus)	+217°C
	Temperature (T_L)	60-150 secs.
Peak Temp (T_P)		+(260+0/-5) °C
Time within 5°C of actual Peak Temp (T_P)		25 secs.
Ramp-down Rate		6°C/sec. Max.
Time 25°C to peak Temp (T_P)		8 min. Max.
Do not exceed		+260°C



RS2A FTHRU RS2MF

VOLTAGE RANGE 50 to 1000 Volts

CURRENT 2.0 Ampere

Disclaimer

The information presented in this document is for reference only. Chongqing changjie Electronic Technology Co., Ltd. reserves the right to make changes without notice for the specification of the products displayed herein to improve reliability, function or design or otherwise.

The product listed herein is designed to be used with ordinary electronic equipment or devices, and not designed to be used with equipment or devices which require high level of reliability and the malfunction of with would directly endanger human life (such as medical instruments, transportation equipment, aerospace machinery, nuclear-reactor controllers, fuel controllers and other safety devices), Changjie or anyone on its behalf, assumes no responsibility or liability for any damages resulting from such improper use of sale.

This publication supersedes & replaces all information previously supplied. For additional information, please visit our website [http:// www.czlangjie.com](http://www.czlangjie.com) , or consult your nearest Langjie's sales office for further assistance.

X-ON Electronics

Largest Supplier of Electrical and Electronic Components

Click to view similar products for [Rectifiers](#) category:

Click to view products by [LangJie](#) manufacturer:

Other Similar products are found below :

[70HFR40](#) [FR105 R0](#) [RL252-TP](#) [1N5397](#) [1N4005-TR](#) [1N4007-BP](#) [UFS120Je3/TR13](#) [20ETS12S](#) [RRE02VS6SGTR](#) [MS306](#) [A1N5404G-G](#)
[CRF02\(T5L,TEMQ\)](#) [ACGRB207-HF](#) [CLH07\(TE16L,Q\)](#) [CLH03\(TE16L,Q\)](#) [1N5395-TP](#) [UES1302](#) [ACGRC307-HF](#) [ACEFC304-HF](#) [DZ-](#)
[1380](#) [85HFR60](#) [40HFR60](#) [70HF120](#) [85HFR80](#) [SCF7500](#) [SM100](#) [ACGRA4001-HF](#) [SKN70/08](#) [NTE5819](#) [NTE5827](#) [NTE5828](#) [NTE5911](#)
[NTE5915](#) [NTE6104](#) [NTE6163](#) [NTE6164](#) [NTE6165](#) [NTE6364](#) [TSD3G](#) [SET130312](#) [NRVUS110VT3G](#) [UES1106](#) [UES1306](#)
[NRVUS240VT3G](#) [D5FE60-5063](#) [R4000GPS-TP](#) [D4015L56TP](#) [UES1306HR2](#) [FX20K120](#) [D20XB60-7101](#)