

SS12F THRU SS120F

VOLTAGE RANGE 20 to 200 Volts  
CURRENT 1.0 Ampere

Features

SMAF



- The plastic package carries Underwriters Laboratory Flammability Classification 94V-0
- For surface mounted applications
- Metal silicon junction, majority carrier conduction
- Low power loss, high efficiency
- Built-in strain relief, ideal for automated placement
- High forward surge current capability
- High temperature soldering guaranteed: 260 C/10 seconds at terminals



Mechanical Data

- Case: Transfer molded plastic
- Epoxy: UL 94V-0 rate flame retardant
- Lead :Solder plated, solderable per MIL-STD-750 method 2026
- Polarity: Color band denotes cathode end
- Weight: 0.00095ounce, 0.028grams

Maximum Ratings and Electrical Characteristics

- Ratings at 25°C ambient temperature unless otherwise specified
- Single phase, half wave, 60Hz, resistive or inductive load
- For capacitive load derate current by 20%

TYPE NUMBER	SYMBOL S	SS 12F	SS 14F	SS 15F	SS 16F	SS 18F	SS 110F	SS 115F	SS 120F	UNIT	
Maximum Repetitive Peak Reverse Voltage	V <sub>RRM</sub>	20	40	50	60	80	100	150	200	Volts	
Maximum RMS Voltage	V <sub>RMS</sub>	14	28	35	42	56	70	105	140	Volts	
Maximum DC Blocking Voltage	V <sub>DC</sub>	20	40	50	60	80	100	150	200	Volts	
Maximum Average Forward Rectified Current at T <sub>L</sub> see figure 1 T <sub>L</sub> = 100°C	I <sub>(AV)</sub>	1.0								Amps	
Peak Forward Surge Current 8.3ms single half sine-wave superimposed on rated load (JEDEC method)	I <sub>FSM</sub>	30								Amps	
Maximum Instantaneous Forward Voltage @ 1.0A(Note1)	V <sub>F</sub>	0.55	0.70	0.85	0.90					Volts	
Maximum DC Reverse Current at rated DC Blocking Voltage per element	T <sub>A</sub> = 25°C	0.1							0.01	mA	
	T <sub>A</sub> = 100°C	20.0				10.0		2.0			
Typical Thermal Resistance (Note 2)	R <sub>θJA</sub>	80								°C/W	
	R <sub>θJL</sub>	32									
Diode junction capacitance (Note 3)	C <sub>J</sub>	260	150							pF	
Operating Junction Temperature	T <sub>J</sub>	(-55 to +150)							(-65 to +175)		°C
Storage Temperature Range	T <sub>STG</sub>	(-55 to +150)									°C

Notes:

1. Pulse test: 300µs pulse width, 1% duty cycle.
2. Unit mounted on P.C.B. with 0.20"×0.20"(5.00mm×5.00mm) copper pads.
3. f=1MHz and applied 4V DC reverse voltage.

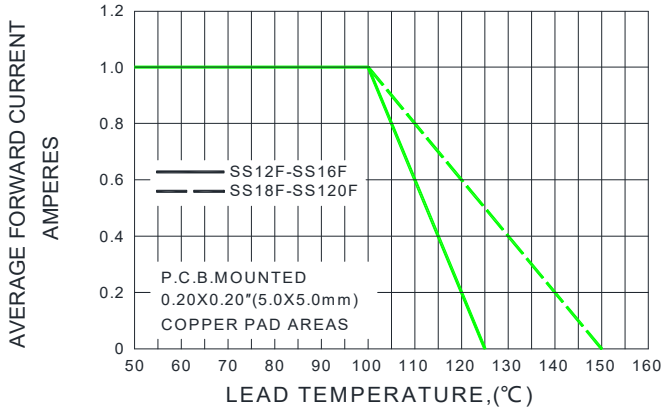
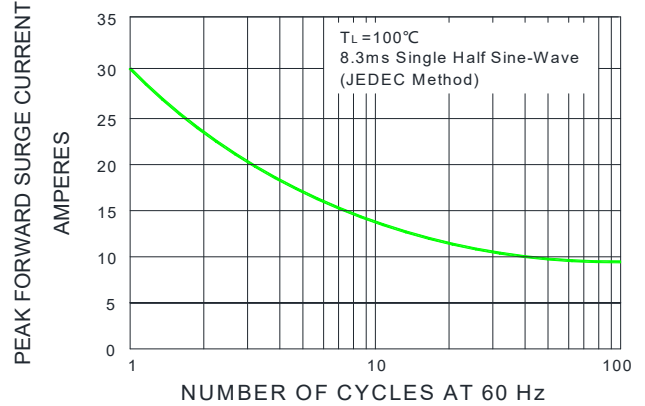
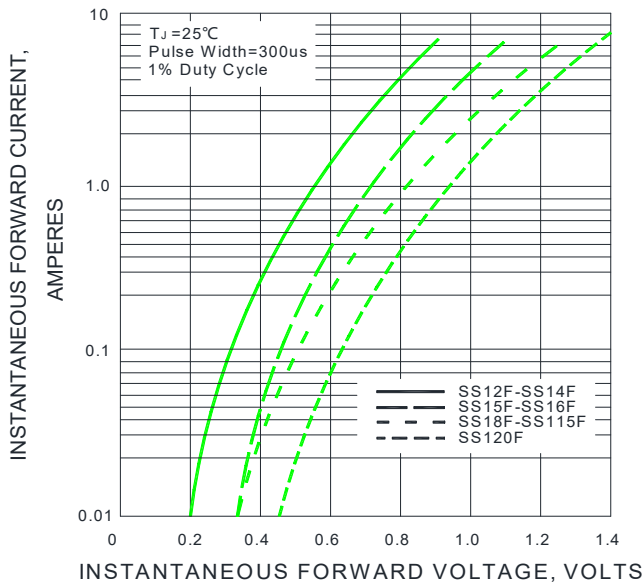
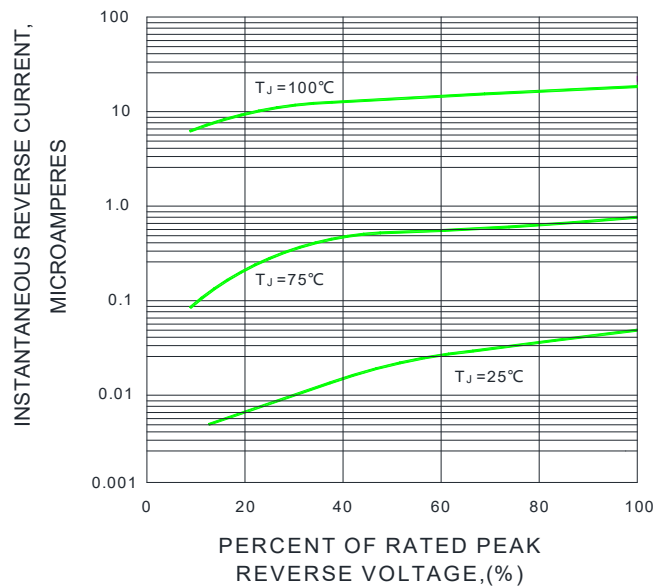
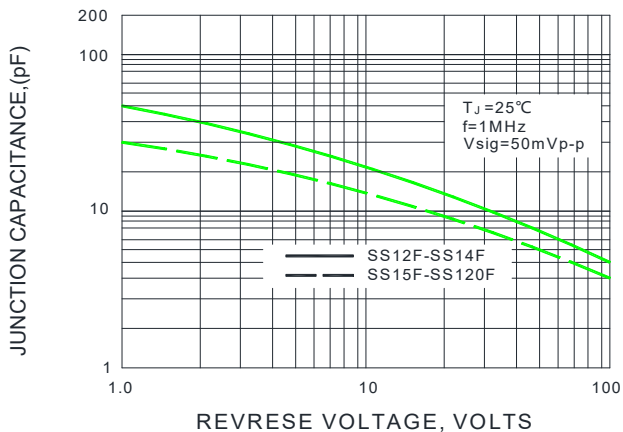
**SS12F THRU SS120F**
**VOLTAGE RANGE 20 to 200 Volts**  
**CURRENT 1.0 Ampere**
**Ratings and Characteristic Curves (TA=25°C unless otherwise noted)**
**FIG.1-FORWARD CURRENT DERATING CURVE**

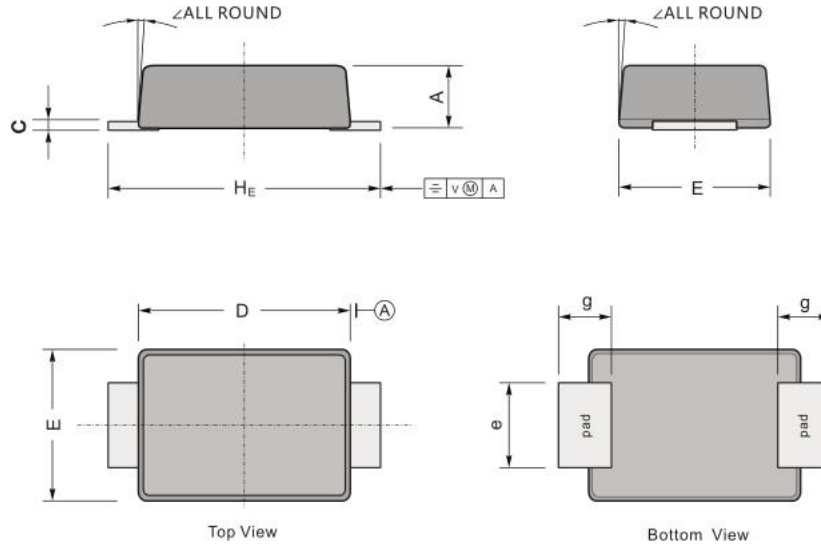
**FIG.2-MAXIMUM NON-REPETITIVE PEAK FORWARD SURGE CURRENT**

**FIG.3-TYPICAL INSTANTANEOUS FORWARD CHARACTERISTICS**

**FIG.4-TYPICAL REVERSE CHARACTERISTICS**

**FIG.5-TYPICAL JUNCTION CAPACITANCE**

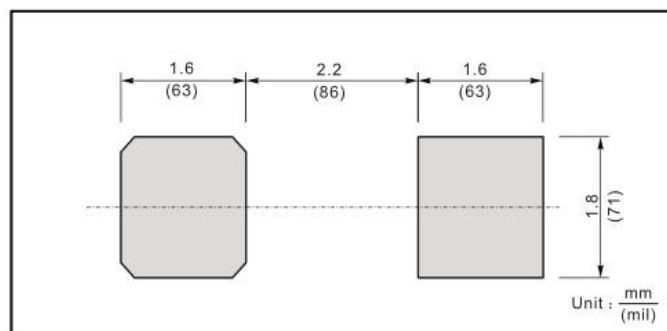
**Package Outline Dimensions in inches (millimeters)**

UNIT		A	C	D	E	e	g	$H_E$	$\angle$
mm	max	1.10	0.20	3.70	2.70	1.60	1.20	4.90	5-7°
	min	0.90	0.12	3.30	2.40	1.30	0.80	4.40	
mil	max	43	7.90	146	106	63	47	193	
	min	35	4.70	130	94	51	31	173	

**The Recommended Mounting Pad Size**
**Marking**

Type number	Marking code
SS12F	SS12F
SS14F	SS14F
SS15F	SS15F
SS16F	SS16F
SS18F	SS18F
SS110F	SS110F
SS115F	SS115F
SS120F	SS120F

**The recommended mounting pad size**

## Packing Requirments

- PS black anti-static carrier tape packing

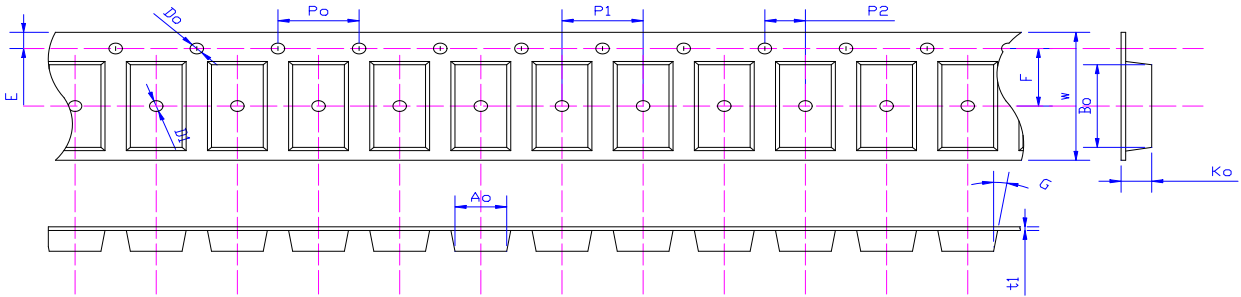

Specifications	$A_o$	$B_o$	$K_o$	$P_o$	$W$	$t_1$
SMAFL	$2.83 \pm 0.10$	$4.90 \pm 0.10$	$1.45 \pm 0.10$	$4.00 \pm 0.1$	$12.0 \pm 0.05$	$0.23 \pm 0.02$

- 13" antistatic plastic reel

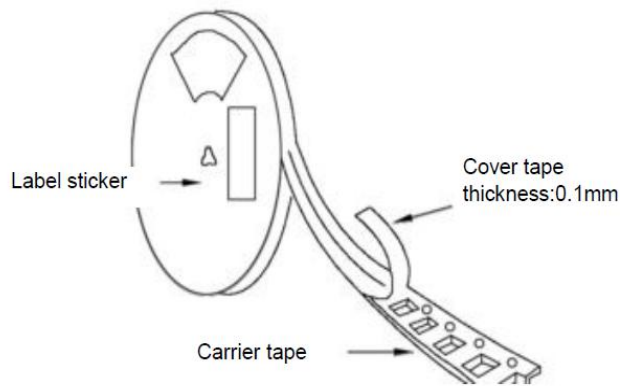

DEVICE TYPE	13" Reel			
	Q'TY/REEL(pcs)	REEL/BOX	BOX/CARTOON	Q'TY/CARTON(pcs)
SMAFL	10000	2	8	160000

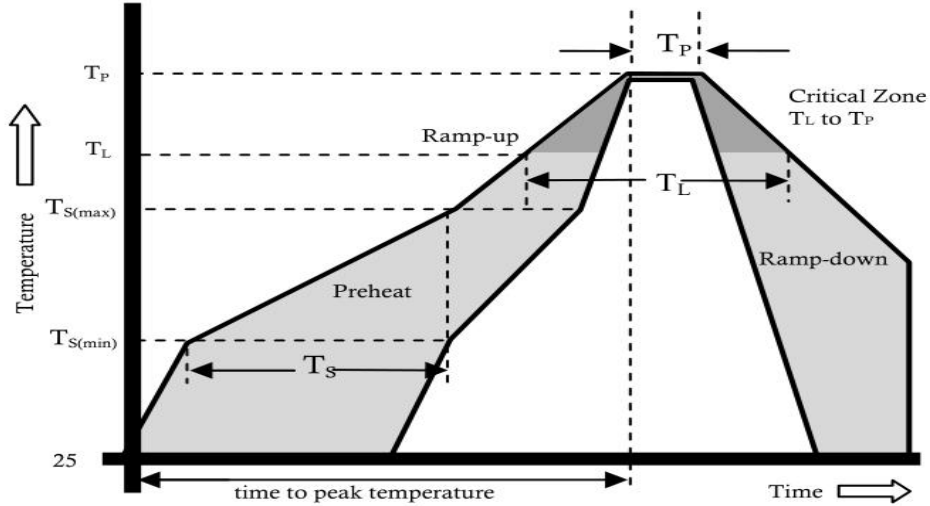
**Reflow Profile**

Reflow Condition		Pb-Free Assembly
Pre Heat	Temperature Min.	+150°C
	Temperature Max.	+200°C
	Time(Min to Max)	60-180 secs.
Average ramp up rate(Liquidus Temp( $T_L$ ) to peak)		3°C/sec. Max.
$T_{S(max)}$ to $T_L$ - Ramp-up Rate		3°C/sec. Max.
Reflow	Temperature ( $T_L$ )(Liquidus)	+217°C
	Temperature ( $T_L$ )	60-150 secs.
Peak Temp ( $T_P$ )		+(260±0/-5) °C
Time within 5°C of actual Peak Temp ( $T_P$ )		25 secs.
Ramp-down Rate		6°C/sec. Max.
Time 25°C to peak Temp ( $T_P$ )		8 min. Max.
Do not exceed		+260°C

## X-ON Electronics

Largest Supplier of Electrical and Electronic Components

*Click to view similar products for [Schottky Diodes & Rectifiers](#) category:*

*Click to view products by [LangJie](#) manufacturer:*

Other Similar products are found below :

[MA4E2039](#) [MMBD301M3T5G](#) [RB160M-50TR](#) [D83C](#) [BAS16E6433HTMA1](#) [BAS 3010S-02LRH E6327](#) [BAT 54-02LRH E6327](#)  
[NRVBAF360T3G](#) [NSR05F40QNXT5G](#) [NTE555](#) [JANS1N6640](#) [SS3003CH-TL-E](#) [GA01SHT18](#) [CRS10I30A\(TE85L,QM](#) [MBRA140TRPBF](#)  
[MBRB30H30CT-1G](#) [BAT 15-04R E6152](#) [JANTX1N5712-1](#) [DMJ3940-000](#) [SB007-03C-TB-E](#) [NRVBB20100CTT4G](#) [NRVBM120LT1G](#)  
[NTSB30U100CT-1G](#) [CRG04\(T5L,TEMQ\)](#) [ACDBA1100LR-HF](#) [ACDBA1200-HF](#) [ACDBA240-HF](#) [ACDBA3100-HF](#) [CDBQC0530L-HF](#)  
[ACDBA260LR-HF](#) [ACDBA1100-HF](#) [10BQ015-M3/5BT](#) [NRVBM120ET1G](#) [VSSB410S-M3/5BT](#) [1N5819T-G](#) [PDS1040Q-13](#) [B160BQ-13-F](#)  
[SDM05U20CSP-7](#) [BAS 70-07 E6433](#) [B140S1F-7](#) [HSM560Je3/TR13](#) [DDB2265-000](#) [ZHCS506QTA](#) [HSM190Je3/TR13](#) [B330AF-13](#)  
[ACDBUC0230-HF](#) [SDM1U100S1F-7](#) [MBR10200CTF-G1](#) [CDLL5712](#) [DMF2822-000](#)