

SS22F THRU SS220F

VOLTAGE RANGE 20 to 200 Volts
CURRENT 2.0 Ampere

Features

SMAFL



- Low profile surface mount package
- Built in strain relief
- High switching speed
- Low voltage drop, high efficiency
- For use in low voltage high frequency inverters, Free willing ,and polarity protection applications
- Guardring for over voltage protection



Mechanical Data

- Case: Transfer molded plastic
- Epoxy: UL 94V-0 rate flame retardant
- Lead :Solder plated, solderable per MIL-STD-750 method 2026
- Polarity: Color band denotes cathode end
- Weight: 0.00095ounce, 0.028grams

Maximum Ratings and Electrical Characteristics

- Ratings at 25°C ambient temperature unless otherwise specified.
- Single phase, half wave, 60Hz, resistive or inductive load.
- For capacitive load derate current by 20%.

TYPE NUMBER	SYMBOL	SS 22F	SS 24F	SS 25F	SS 26F	SS 28F	SS 210F	SS 215F	SS 220F	UNIT
Maximum Repetitive Peak Reverse Voltage	V_{RRM}	20	40	50	60	80	100	150	200	Volts
Maximum RMS Voltage	V_{RMS}	14	28	35	42	56	70	105	140	Volts
Maximum DC Blocking Voltage	V_{DC}	20	40	50	60	80	100	150	200	Volts
Maximum Average Forward Rectified Current at T_L see figure 1 $T_L = 100^\circ C$	$I_{(AV)}$	2.0								Amps
Peak Forward Surge Current 8.3ms single half sine-wave superimposed on rated load (JEDEC method)	I_{FSM}	50								Amps
Maximum Instantaneous Forward Voltage @ 2.0A(Note1)	V_F	0.55	0.70		0.85		0.95		Volts	
Maximum DC Reverse Current at rated DC Blocking Voltage per element	$T_A = 25^\circ C$	0.1							0.01	mA
	$T_A = 100^\circ C$	20.0				10.0		2.0		
Typical Thermal Resistance (Note 2)	$R_{\theta JA}$	55								$^\circ C/W$
	$R_{\theta JL}$	25								
Diode junction capacitance (Note 3)	C_J	30								pF
Operating Junction Temperature	T_J	(-55 to +150)				(-65 to +150)				$^\circ C$
Storage Temperature Range	T_{STG}	(-55 to +150)								$^\circ C$

Notes:

1. Pulse test:300 μ s pulse width,1% duty cycle.
2. Unit mounted on P.C.B. with 0.20"×0.20"(5.00mm×5.00mm) copper pads.
3. f=1MHz and applied 4V DC reverse voltage.

SS22F THRU SS220F
VOLTAGE RANGE 20 to 200 Volts
CURRENT 2.0 Ampere

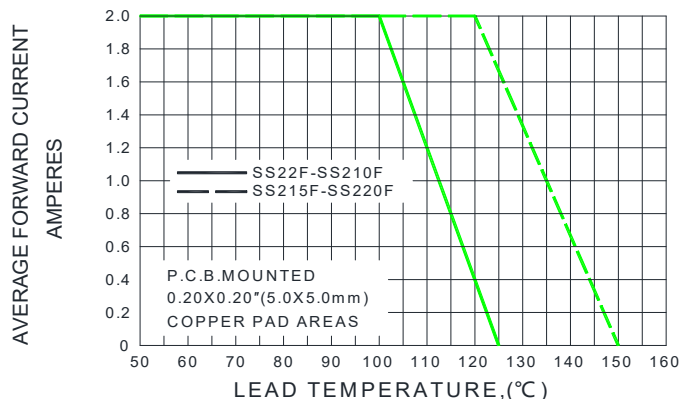
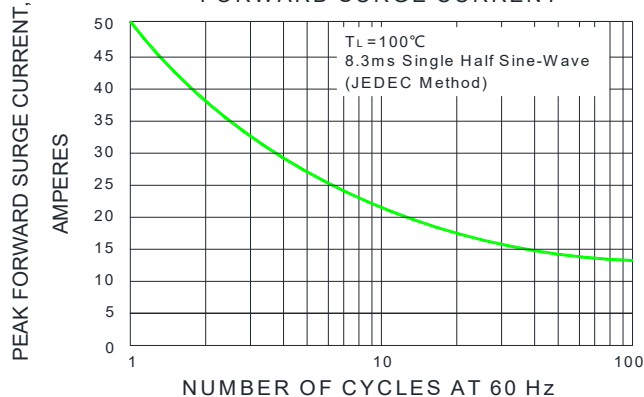
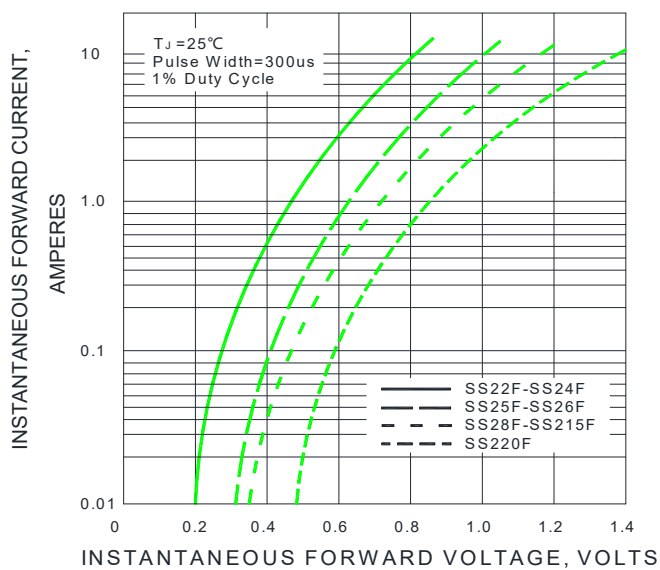
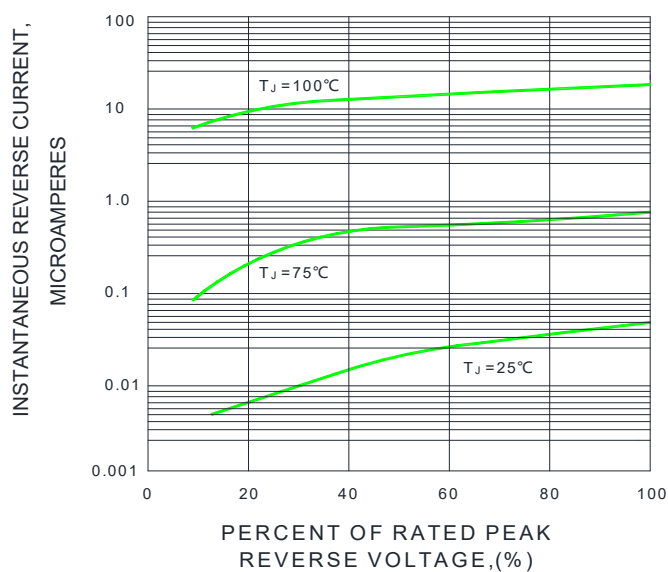
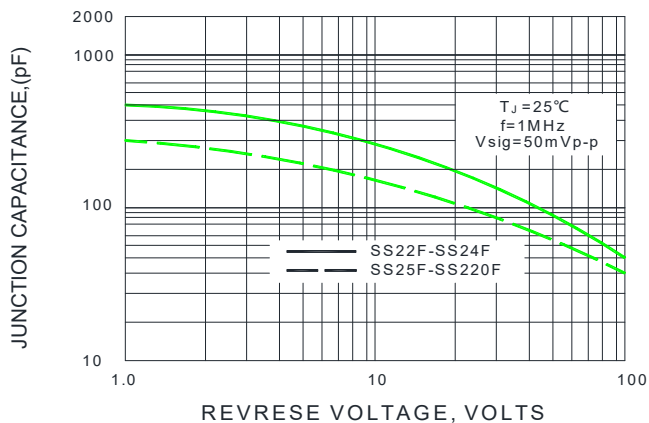
Ratings and Characteristic Curves (TA=25°C unless otherwise noted)
FIG.1-FORWARD CURRENT DERATING CURVE

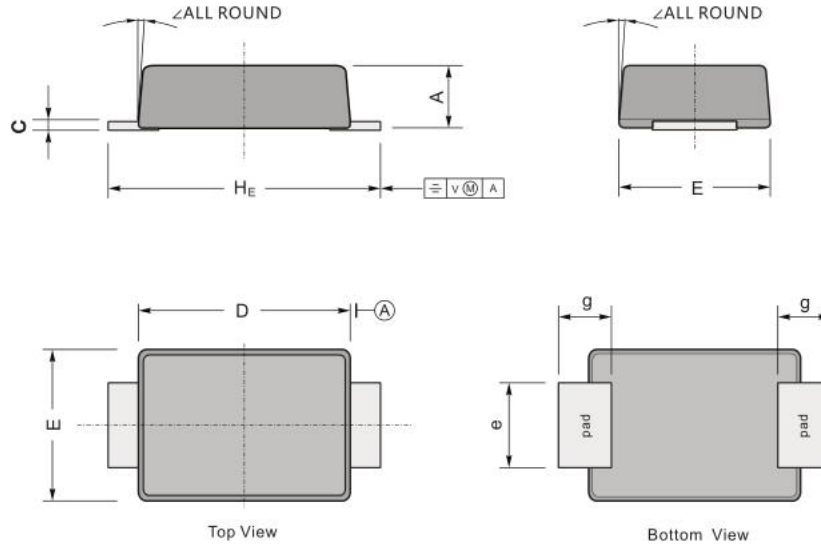
FIG.2-MAXIMUM NON-REPETITIVE PEAK FORWARD SURGE CURRENT

FIG.3-TYPICAL INSTANTANEOUS FORWARD CHARACTERISTICS

FIG.4-TYPICAL REVERSE CHARACTERISTICS

FIG.5-TYPICAL JUNCTION CAPACITANCE

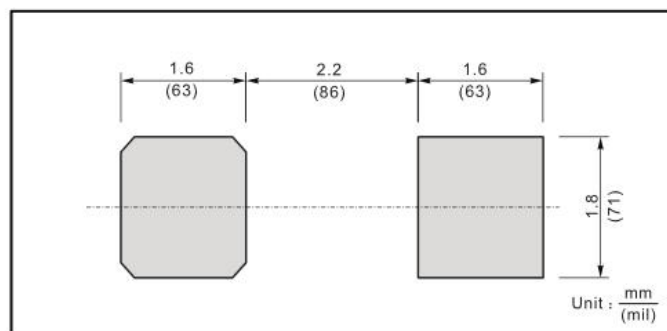
Package Outline Dimensions in inches (millimeters)

UNIT		A	C	D	E	e	g	H _E	∠
mm	max	1.10	0.20	3.70	2.70	1.60	1.20	4.90	5-7°
	min	0.90	0.12	3.30	2.40	1.30	0.80	4.40	
mil	max	43	7.90	146	106	63	47	193	
	min	35	4.70	130	94	51	31	173	

The Recommended Mounting Pad Size
Marking

Type number	Marking code
SS22F	SS22F
SS24F	SS24F
SS25F	SS25F
SS26F	SS26F
SS28F	SS28F
SS210F	SS210F
SS215F	SS215F
SS220F	SS220F

The recommended mounting pad size

Packing Requirments

- PS black anti-static carrier tape packing

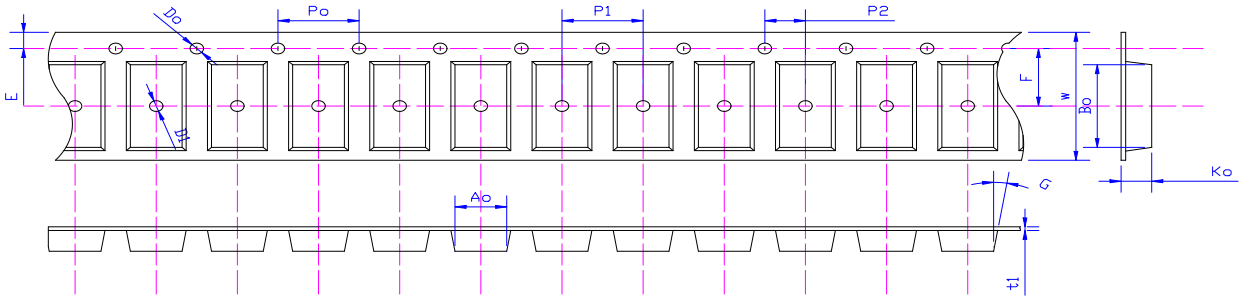

Specifications	A_o	B_o	K_o	P_o	W	t_1
SMAFL	2.83 ± 0.10	4.90 ± 0.10	1.45 ± 0.10	4.00 ± 0.1	12.0 ± 0.05	0.23 ± 0.02

- 13" antistatic plastic reel

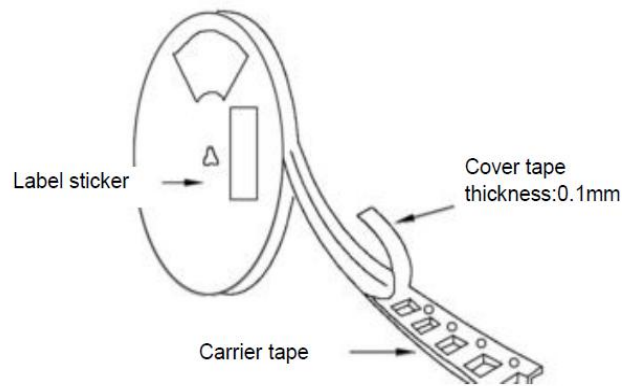

DEVICE TYPE	13" Reel			
	Q'TY/REEL(pcs)	REEL/BOX	BOX/CARTOON	Q'TY/CARTON(pcs)
SMAFL	10000	2	8	160000

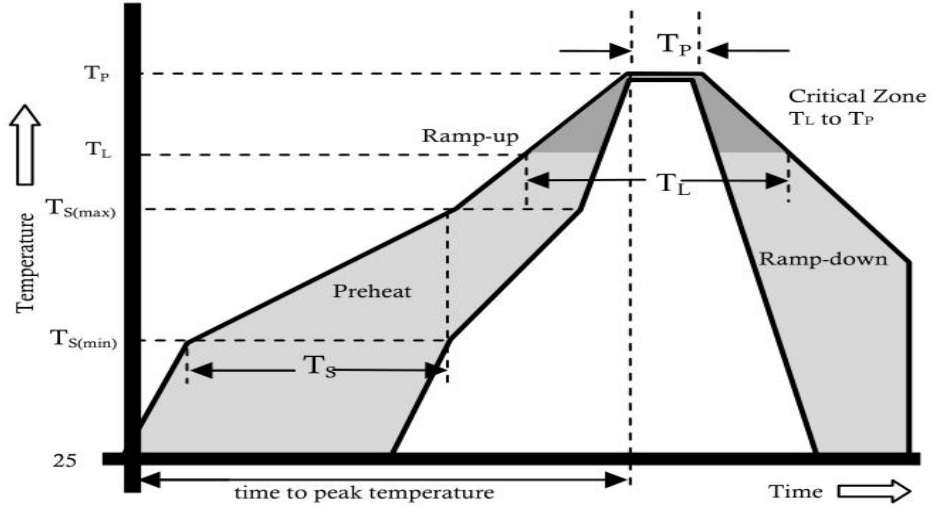
Reflow Profile

Reflow Condition		Pb-Free Assembly
Pre Heat	Temperature Min.	+150°C
	Temperature Max.	+200°C
	Time(Min to Max)	60-180 secs.
Average ramp up rate(Liquidus Temp(T_L) to peak)		3°C/sec. Max.
$T_{S(max)}$ to T_L - Ramp-up Rate		3°C/sec. Max.
Reflow	Temperature (T_L)(Liquidus)	+217°C
	Temperature (T_L)	60-150 secs.
Peak Temp (T_P)		+(260+0/-5) °C
Time within 5°C of actual Peak Temp (T_P)		25 secs.
Ramp-down Rate		6°C/sec. Max.
Time 25°C to peak Temp (T_P)		8 min. Max.
Do not exceed		+260°C

X-ON Electronics

Largest Supplier of Electrical and Electronic Components

Click to view similar products for [Schottky Diodes & Rectifiers](#) category:

Click to view products by [LangJie](#) manufacturer:

Other Similar products are found below :

[MA4E2039](#) [MMBD301M3T5G](#) [RB160M-50TR](#) [D83C](#) [BAS16E6433HTMA1](#) [BAS 3010S-02LRH E6327](#) [BAT 54-02LRH E6327](#)
[NRVBAF360T3G](#) [NSR05F40QNXT5G](#) [NTE555](#) [JANS1N6640](#) [SS3003CH-TL-E](#) [GA01SHT18](#) [CRS10I30A\(TE85L,QM](#) [MBRA140TRPBF](#)
[MBRB30H30CT-1G](#) [BAT 15-04R E6152](#) [JANTX1N5712-1](#) [DMJ3940-000](#) [SB007-03C-TB-E](#) [NRVBB20100CTT4G](#) [NRVBM120LT1G](#)
[NTSB30U100CT-1G](#) [CRG04\(T5L,TEMQ\)](#) [ACDBA1100LR-HF](#) [ACDBA1200-HF](#) [ACDBA240-HF](#) [ACDBA3100-HF](#) [CDBQC0530L-HF](#)
[ACDBA260LR-HF](#) [ACDBA1100-HF](#) [10BQ015-M3/5BT](#) [NRVBM120ET1G](#) [VSSB410S-M3/5BT](#) [1N5819T-G](#) [PDS1040Q-13](#) [B160BQ-13-F](#)
[SDM05U20CSP-7](#) [BAS 70-07 E6433](#) [B140S1F-7](#) [HSM560Je3/TR13](#) [DDB2265-000](#) [ZHCS506QTA](#) [HSM190Je3/TR13](#) [B330AF-13](#)
[ACDBUC0230-HF](#) [SDM1U100S1F-7](#) [MBR10200CTF-G1](#) [CDLL5712](#) [DMF2822-000](#)