



Description

Lantronix® PremierWave® 2050 enterprise Wi-Fi® IoT module is a series of embedded modules offering reliable and always-on 5G (802.11ac) enterprise Wi-Fi connectivity for mission critical industrial and commercial applications.

Building and maintaining Wi-Fi connectivity software and keeping up with the pace of innovation in Wi-Fi technologies can consume significant resources in budget and time. With the PremierWave 2050 module, design engineers and system architects can reduce product development time and deploy their devices with confidence that their products will connect and work as expected. With optimized hardware and robust software for Wi-Fi connection management, secure system management and configuration functions, and robust Ethernet to Wi-Fi bridging, the PremierWave 2050 module lets you ease the deployment and support of your Wi-Fi enabled product.

Secure Wi-Fi connectivity requires supporting scalable enterprise class Wi-Fi via Extensible Authentication Protocol (EAP) methods and secure AES (CCMP) ciphers. To protect management interfaces, PremierWave 2050 uses SSL/TLS and SSH for data encryption and PKI/certificate management for authentication and key management. In addition, PremierWave 2050 offers firewall features to block ports and has NIST-certified AES encryption.

Featuring a direct Wi-Fi service via the Soft Access Point (SoftAP) interface, the PremierWave 2050 provides operational technology (OT) and field support teams to install, provision, monitor or perform diagnostics and ongoing maintenance of the connected machines without interrupting the machine's primary connection or requiring special access to the secure enterprise network.

PremierWave 2050 has modular RF certification for many regions and is Wi-Fi Alliance certified, thereby making it easy to use these certifications for the end product without going through an extensive certification cycle. This saves development costs and mitigates schedule and time-to-market risks.

Applications

The PremierWave 2050 is designed for applications in a variety of industries where reliability, extended operating temperature range, and robust wireless connectivity are mission critical.

Key applications include:

- ♦ Industrial automation
- ♦ Industrial machines
- ♦ Asset and warehouse management
- ♦ Medical devices
- ♦ Healthcare
- ♦ Retail/POS
- ♦ Environmental monitoring
- ♦ Military
- ♦ Railway and transportation

PremierWave 2050 is particularly well-suited for products requiring long lifecycles in highly regulated industries where the constant change in Wi-Fi technologies and certification would typically make it difficult to incorporate a wireless solution.

Features

- ♦ Industrial grade 5G (802.11ac) Wi-Fi module for high performance enterprise IoT
- ♦ Enterprise grade security (WPA2 enterprise, SSL, TLS)
- ♦ Fully certified module mitigates regulatory and product availability risks
- ♦ Production ready SW with compact footprint
- ♦ Simplified manufacturing and deployment time provisioning workflows
- ♦ Simultaneous AP and client access
- ♦ Ethernet to Wi-Fi bridge (AP and/or Wi-Fi client)
- ♦ Serial, SPI, USB host interfaces
- ♦ Antenna diversity with on-module antenna or U.FL connectors
- ♦ Industrial operating temperature: -40C to +85C
- ♦ 5 Year Warranty

Table of Contents

Description	1
Applications	1
Features	1
List of Figures	3
List of Tables	4
1: Introduction	5
2: Hardware and Software Description	6
3: Host Interfaces	8
Ethernet	8
UART	8
Serial Peripheral Interface (SPI)	9
SPI Interface Characteristics	12
USB Device	12
Configurable General Purpose I/O Pins (GPIO)	13
System Pins	14
4: IEEE 802.11 Wireless Lan Specifications	15
Regional Power Codes	16
5: Antenna Connection Options	18
6: General Technical Data	19
7: Electrical Characteristics	20
Recommended Operating Conditions	20
DC Characteristics – Digital I/O Signals	20
Dynamic Power Management Modes	21
Output Power	21
Power, Reset, Wake, Shutdown and Default Timing	22
EVM	23
Receive Sensitivity	24
Memory	24
8: Package Description and Mechanical Footprint	25
Pin and Pad Definitions	27

9: Product Information Label	32
10: Evaluation Kit	33
11: Compliance	34
Federal Communication Commission Interference Statement _____	35
Industry Canada statement: _____	36
Europe – EU Declaration of Conformity _____	39
RoHS, REACH, and WEEE Compliance Statement _____	41
12: Ordering Information	42
Contact Information _____	42
Warranty _____	43

List of Figures

Figure 1 PremierWave 2050 Block Diagram _____	6
Figure 2 PremierWave 2050 Pad and Antenna Port Locations _____	7
Figure 3 SPI Timing Diagram – Master Mode _____	10
Figure 4 SPI Timing Diagram - Slave Mode _____	11
Figure 5 SPI Timing Diagram – Slave Mode NPCS Timing _____	11
Figure 6 Reset Timing _____	22
Figure 7 Reset to Defaults Timing _____	22
Figure 8 Wake Timing _____	22
Figure 9 Shutdown Pin Timing _____	23
Figure 10 PW20502 Enterprise Wi-Fi IoT Wi-Fi Module _____	25
Figure 11 Layout Footprint for PremierWave 2050 Enterprise Wi-Fi IoT Module _____	26
Figure 12 PremierWave 2050 Module Label _____	32
Figure 13 EU Declaration of Conformity _____	39

List of Tables

Table 1: PremierWave 2050 Ethernet Signal Definitions	8
Table 2: PremierWave 2050 Signal Definitions	9
Table 3: PremierWave 2050 Module UART Signal Definitions	9
Table 4: PremierWave 2050 Module SPI Characteristic	12
Table 5: PremierWave 2050 Module USB Signal Definitions	12
Table 6: PremierWave 2050 Module GPIO Signal Definitions	13
Table 7: PremierWave 2050 Module System Signal Definitions	14
Table 8: PremierWave 2050 Module Radio Specification	15
Table 9: 20 MHz Channels	16
Table 10: 40 MHz Channels	17
Table 11: 80 MHz Channels	17
Table 12: PW20501 Module External Antenna Options	18
Table 13: PW20502 Module On-Module Antenna	18
Table 14: General Technical Data	19
Table 15: Recommended Operating Conditions for PremierWave 2050 Module	20
Table 16: DC Characteristics – Digital I/O Signals	20
Table 17: PremierWave 2050 Power Management Modes	21
Table 18: PremierWave 2050 Module RF Output Power	21
Table 19: PremierWave 2050 Module Wi-Fi EVM	23
Table 20: PremierWave 2050 Module Rx Sensitivity	24
Table 21: PremierWave 2050 Interface Signal Definitions:	27
Table 23: Datamatrix ECC200 Barcode Standard Field Definitions	32
Table 24: Country Certifications	34
Table 25: Country Transmitter IDs	34
Table 26: Safety	35
Table 27: Europe – EU Declaration of Conformity	40
Table 28: Approved External Antenna(s) List	41
Table 28: Ordering Information	42

1: Introduction

Delivering reliable and always on 5G Wi-Fi (802.11ac) connectivity, the Lantronix PremierWave 2050 solution is a series of embedded modules designed specifically for sensitive, mission critical, industrial and commercial applications. With a production ready software stack and modular RF certification, the PremierWave 2050 simplifies deployments and accelerates availability of robust WLAN connected IoT products.

The PremierWave 2050 is a highly integrated module that includes an 802.11 a/b/g/n/ac compliant MAC, BB and PHY subsystem along with the WLAN software stack to completely offload all Wi-Fi functions from the connected microcontroller or host device.

By using the available 10/100 Mbps Ethernet interface commonly available on many host microprocessors, customers can enable enterprise Wi-Fi connectivity with very little integration and system design effort.

PremierWave 2050 module eliminates the complexity for OEMs seeking an elegant and robust solution that allows them to speed up their time-to-confidence by considerably reducing development and solution deployment risks associated with wireless IoT-enabled products.

Featuring certified 5G Wi-Fi connectivity, an advanced wireless software stack, integrated enterprise-level security and an industrial-rated but compact design, the PremierWave 2050 is the perfect solution for mission critical applications.

- ◆ First industrial rated 802.11ac Wi-Fi module (2.4 GHz and 5 GHz) for high performance enterprise IoT
- ◆ Embedded Ethernet to Wi-Fi bridge and router modes with enterprise Wi-Fi security
- ◆ Direct mobile to device service interface via SoftAP or Wi-Fi Direct® technology
- ◆ Simultaneous AP and client (STA), AP only, client (STA) only modes
- ◆ Integrated enterprise security and management features
- ◆ Ethernet, USB, serial – host interfaces
- ◆ Compact system-on-module SMT footprint with antenna diversity (46 mm x 45 mm x 3.5 mm)
- ◆ Operating temperature range: -40°C to +85°C
- ◆ M2M/IoT expertise and world class support
- ◆ Fully certified module mitigates regulatory risks
- ◆ Wi-Fi Alliance® Certified
- ◆ Long term availability and modular footprint to protect design investment
- ◆ 5 Year warranty

2: Hardware and Software Description

The PremierWave 2050 module is a highly integrated module that includes an ARM9 controller, 802.11 a/b/g/n/ac MAC/BB and PHY, RAM, flash and antenna connectors and a complete software stack that enables robust enterprise Wi-Fi connectivity for Ethernet enabled devices.

The SMT (LGA) module package also offers additional host connectivity interfaces such as UART, SPI and USB along with I2C, GPIOs and control lines to support integration with other host based systems as well as host-less architectures.

The wireless sub-system supports advanced Wi-Fi features such as a SoftAP with support for client devices, Wi-Fi Direct and simultaneously connection and communication via both the AP and client Wi-Fi interfaces.

The PremierWave 2050 module runs on 5V power with 3.3V logic, and has a built-in voltage supervisory circuit.

Figure 1 PremierWave 2050 Block Diagram

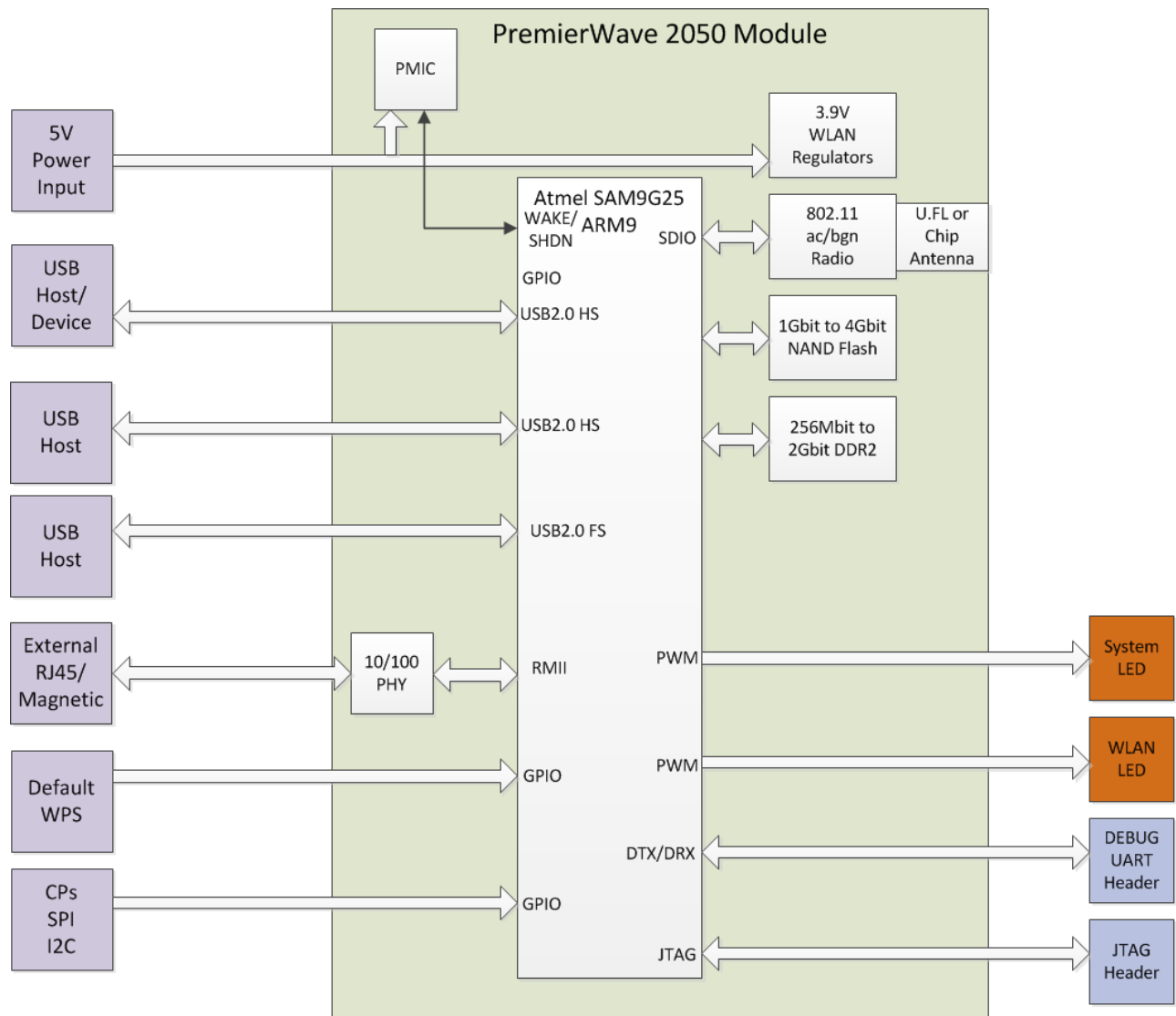
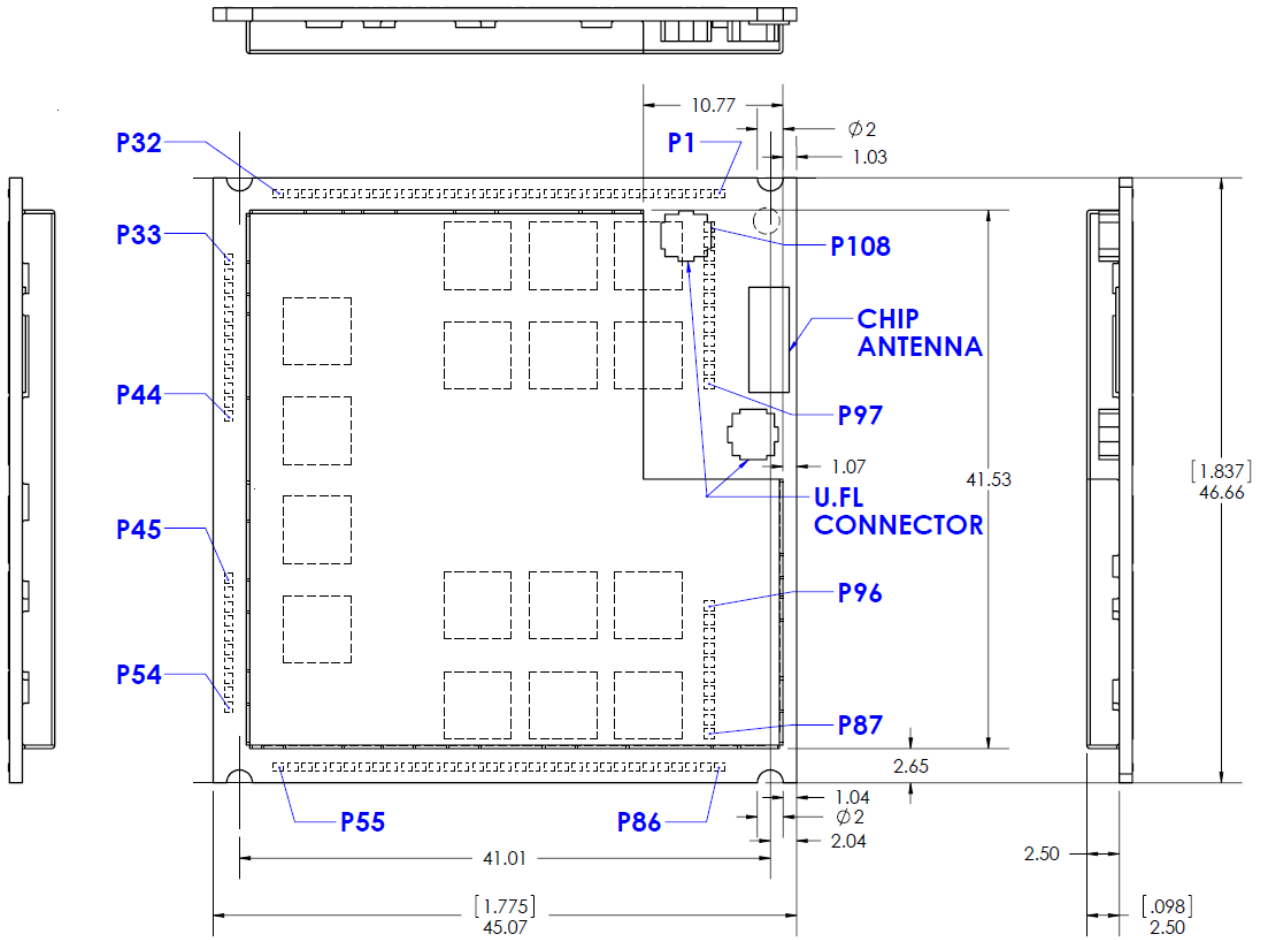

Figure 2 PremierWave 2050 Pad and Antenna Port Locations



3: Host Interfaces

The PremierWave 2050 module offers a number of common interfaces to allow for easy connectivity to the module. These include 10/100Mbps Ethernet, UART for asynchronous serial communication, serial peripheral interface for synchronous formatted data, and USB host interface.

Ethernet

The PremierWave 2050 module has an integrated 10/100Mbps Ethernet MAC and PHY. External magnetics and RJ45 are required for connection to a standard Ethernet network. See the *PremierWave 2050 Enterprise Wi-Fi IoT Module Integration Guide* available at www.lantronix.com/support/documentation for more details.

Table 1: PremierWave 2050 Ethernet Signal Definitions

Signal	SMT Pin	Description
ERXM	41	Ethernet receives negative signal.
EXRP	40	Ethernet receives positive signal.
ETXM	35	Ethernet transmits negative signal.
ETXP	34	Ethernet transmits positive signal.
RXCT	38	Center tap for receive pair.
TXCT	37	Center tap for transmit pair
E_LNKACT	72	Link / activity LED. Active low. Solid for link, blink for activity.
E_SPEED	56	Link speed active low for 100 Mbps, Off (high) for 10 Mbps.

UART

- ◆ The PremierWave 2050 module supports two UART interfaces (UART1, UART2)
- ◆ Both UARTs support asynchronous data rate up to 921 Kbps, with Odd/Even parity, and 1 & 2 stop bits
- ◆ Software flow control (Xon, Xoff)
- ◆ Operational mode as a DTE device
- ◆ Both UARTS support TX, RX, RTS, CTS (hardware flow control)

Table 2: PremierWave 2050 Signal Definitions

Signal	SMT Pin	Description
TXD1	83	Serial port 1 transmit data output
RXD1	82	Serial port 1 receive data Input
RTS1	81	Serial port 1 ready-to-send/ serial transmit enable
CTS1	80	Serial port 1 clear to send
TXD2	79	Serial port 2 transmit data output
RXD2	78	Serial port 2 receive data input
RTS2	24	Serial port 2 ready-to-send/ serial transmit enable
CTS2	25	Serial port 2 clear to send

Serial Peripheral Interface (SPI)

The PremierWave 2050 module has a slave/master SPI interface that can be clocked at 30 MHz. The SPI is multiplexed with five configurable GPIO pins and is managed by configuration at system initialization.

- ◆ Five wire interface consisting of Serial In, Serial Out, Chip Select, Serial Clock and Interrupt
- ◆ Configurable master and slave mode

Table 3: PremierWave 2050 Module UART Signal Definitions

Signal	SMT Pin	Description
SPI_INT	68	SPI interrupt external interrupt input
SPI_CLK	14	SPI clock
MISO	12	SPI master serial data input, SPI slave serial data output
MOSI	13	SPI master serial data output, SPI slave serial data input
SPI_CS	15	SPI chip select

The figure below shows the relative timings on the SPI interface of the PremierWave 2050 module.

Figure 3 SPI Timing Diagram – Master Mode

SPI Master Mode 1 and 2

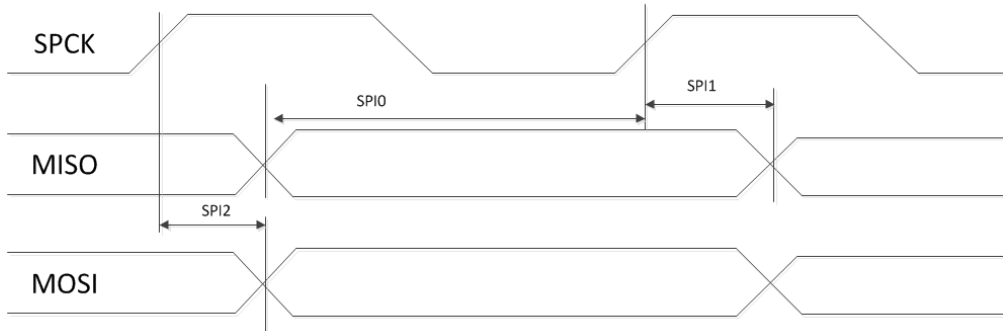

SPI Master Mode 0 and 3

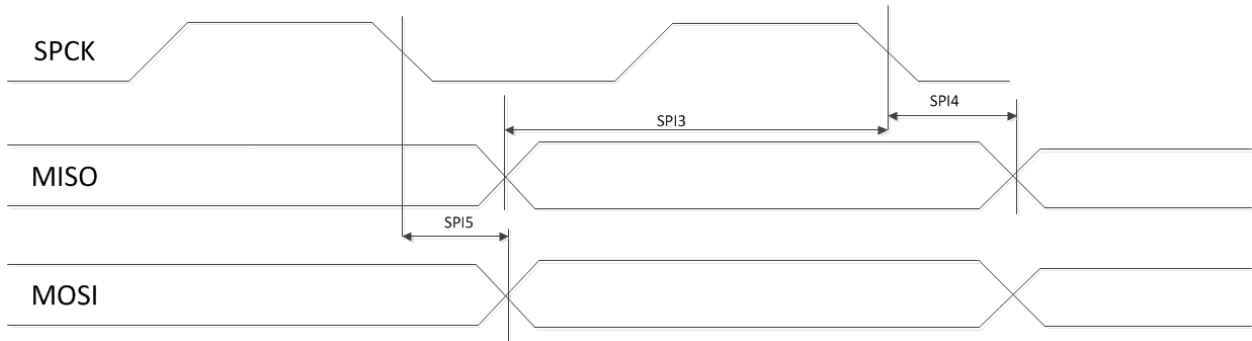

Figure 4 SPI Timing Diagram - Slave Mode

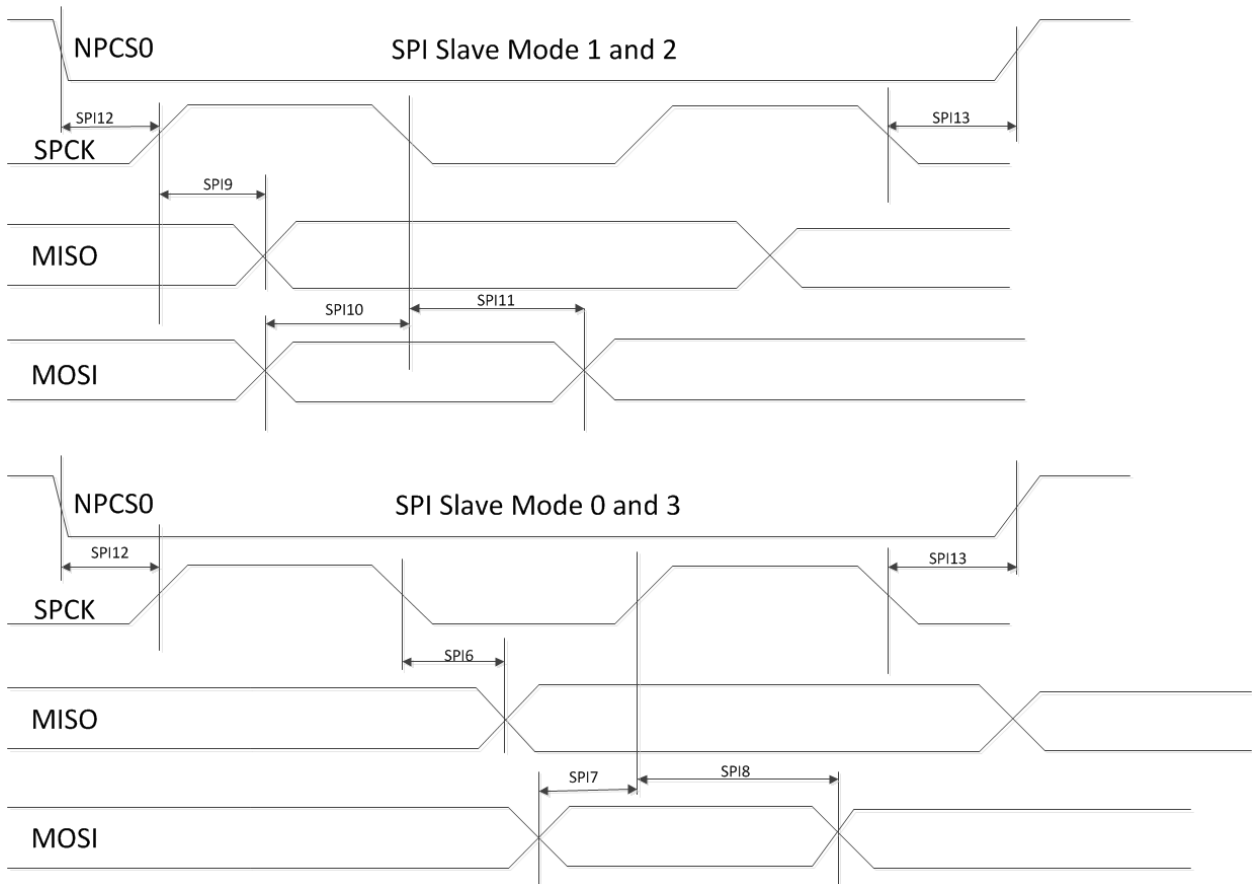
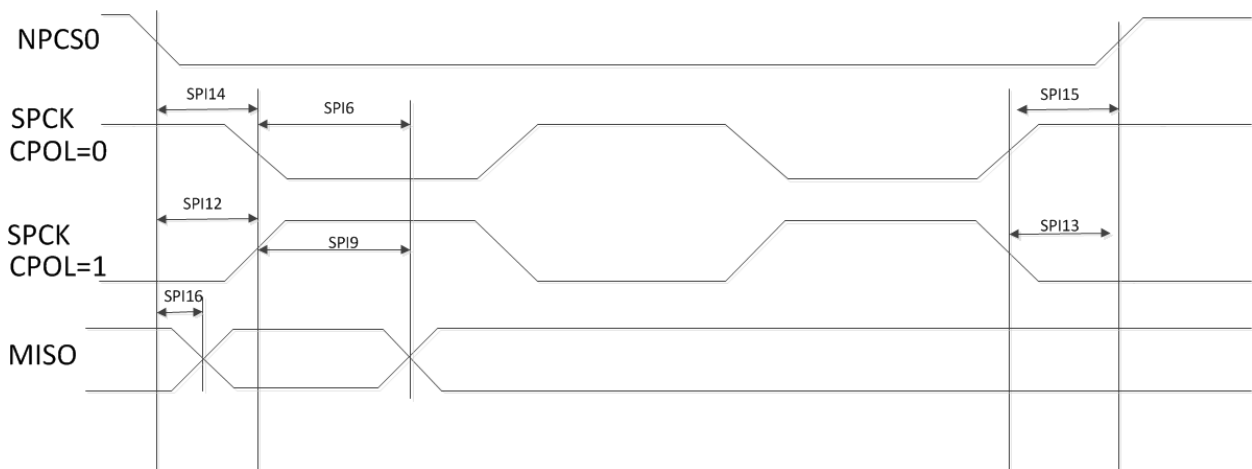

Figure 5 SPI Timing Diagram – Slave Mode NPCS Timing



SPI Interface Characteristics

Unless otherwise specified, the parameters given in the table below for SPI are derived from tests performed under the ambient temperature of +25C, and VCC = 5V, logic voltage 3.3V.

Table 4: PremierWave 2050 Module SPI Characteristic

Symbol	Parameter	Conditions	Min	Max	Unit
SPI _{SPCK}	SPI Clock	Master Mode		66	MHz
SPI ₀	MISO setup time before SPCK rises		13.3		ns
SPI ₁	MISO hold time after SPCK rises		0		ns
SPI ₂	SPCK rising to MOSI		0	7.4	ns
SPI ₃	MISO setup time before SPCK falls		12.8		ns
SPI ₄	MISO hold time after SPCK falls		0		ns
SPI ₅	SPCK falling to MOSI		0	7.6	ns
SPI ₆	SPCK falling to MISO		2.9	12.7	ns
SPI ₇	MOSI setup time before SPCK rises	Slave Mode	2.0		ns
SPI ₈	MOSI hold time after SPCK rises		0		ns
SPI ₉	SPCK rising to MISO		2.7	13.3	ns
SPI ₁₀	MOSI setup time before SPCK falls		1.7		ns
SPI ₁₁	MOSI hold time after SPCK falls		0		ns
SPI ₁₂	NPCSO setup to SPCK rising		3.8		ns
SPI ₁₃	NPCSO hold after SPCK falling		0		ns
SPI ₁₄	NPCSO setup to SPCK falling		3.5		ns
SPI ₁₅	NPCSO hold after SPCK rising		0		ns
SPI ₁₆	NPCSO falling to MISO valid			15.4	ns

USB Device

The PremierWave 2050 module has three USB port interfaces.

- ◆ One USB 2.0 high speed host/device port
- ◆ One USB 2.0 high speed host port
- ◆ One USB 2.0 full speed host port
- ◆ Support for USB CDC/ACM serial profile¹ which will have the module appear as a CDC/ACM device enumerated as a virtual COM port.

Table 5: PremierWave 2050 Module USB Signal Definitions

Signal	SMT Pin	Description
USB1+	18	USB 2.0 HS host/device port positive pin
USB1-	19	USB 2.0 HS host/device port negative pin

¹ Available in a future release. Contact your local sales representative for availability.

Signal	SMT Pin	Description
USB2+	21	USB 2.0 HS Host Port Positive Pin
USB2-	22	USB 2.0 HS Host Port Negative Pin
USB3+	52	USB 2.0 FS Host Port Positive Pin
USB3-	53	USB 2.0 FS Host Port Negative Pin

Configurable General Purpose I/O Pins (GPIO)

The PremierWave 2050 module provides up to 13 configurable General Purpose Input/Output (GPIO) pins. Certain of the GPIOs are multiplexed with other interface functions (e.g. SPI). Mapping of these functions to CPs will be driven via configuration and applied at system initialization.

Each CP can be configured as a general purpose input, general purpose output, microcontroller peripheral block or a soft function. These pins are 3.3V CMOS logic level tolerant.

Table 6: PremierWave 2050 Module GPIO Signal Definitions

Signal	SMT Pin	Description
CP1	71	Configurable I/O
CP2/INT	68	Configurable I/O-SPI interrupt input
CP3	12	Configurable I/O- SPI MISO
CP4	13	Configurable I/O-SPI MOSI
CP5	16	Configurable I/O
CP6	17	Configurable I/O
CP7	14	Configurable I/O-SPI Clock
CP8	15	Configurable I/O-SPI Chip Select
CP9	26	Configurable I/O
CP10	60	Configurable I/O
CP11	59	Configurable I/O
CP12	58	Configurable I/O
CP13	57	Configurable I/O

System Pins

The following system pins are available in the product:

Table 7: PremierWave 2050 Module System Signal Definitions

Signal	SMT Pin	Description
EXT_RESET#	77	Unit hardware reset, active low. Drive low for 50 ms to reboot unit. Signal should be driven high or left floating after reset.
DEFAULT#	66	Unit reset to default, active low. Drive low for 5 to 6 seconds to reset unit to default settings.
WAKE ²	65	Toggle signal from low to high to WAKE from SLEEP or power down state
SHDN ³	88	Active low when module is in the shutdown state

² Available in a future release. Contact your local sales representative for availability.

³ Available in a future release. Contact your local sales representative for availability.

4: IEEE 802.11 Wireless Lan Specifications

The table below provides the specifications and performance attributes for the PremierWave 2050 module IEEE 802.11 radio.

Table 8: PremierWave 2050 Module Radio Specification

Feature	Description
Frequency Band	2.412 – 2.484 GHz (channels 1 – 14) 4.9 to 5.845 Ghz Channels dependent on assigned country code
Supported Data Rates	802.11ac/bgn (20, 40, and 80 Mhz channels) a, b, g data rates up to 54 Mbps ac/n data rates 802.11ac/n up to MCS9
Modulation	OFDM with BPSK, QPSK, 16-QAM, 64-QAM, 256-QAM 801.11b with CCK and DSSS
802.11 MAC Features	WEP, WPA, WPA2, WMM, WMM-PS (UAPSD), WMM-SA, AES, TKIP, CKIP
802.11 PHY Features	802.11b, 802.11g, 802.11n, 802.11a, 802.11ac (single-stream)
802.11 modes	ac/n/a/b/g/d/h/i

Regional Power Codes

Table 9: 20 MHz Channels

	Frequency	Channel	FCC/USA	Canada	Europe	Australia	New Zealand	Japan	China	Israel	Mexico
2.4 GHz Band	2412	1	Yes	Yes	Yes	Yes	Yes	Yes	Yes	Yes	Yes
	2417	2	Yes	Yes	Yes	Yes	Yes	Yes	Yes	Yes	Yes
	2422	3	Yes	Yes	Yes	Yes	Yes	Yes	Yes	Yes	Yes
	2427	4	Yes	Yes	Yes	Yes	Yes	Yes	Yes	Yes	Yes
	2432	5	Yes	Yes	Yes	Yes	Yes	Yes	Yes	Yes	Yes
	2437	6	Yes	Yes	Yes	Yes	Yes	Yes	Yes	Yes	Yes
	2442	7	Yes	Yes	Yes	Yes	Yes	Yes	Yes	Yes	Yes
	2447	8	Yes	Yes	Yes	Yes	Yes	Yes	Yes	Yes	Yes
	2452	9	Yes	Yes	Yes	Yes	Yes	Yes	Yes	Yes	Yes
	2457	10	Yes	Yes	Yes	Yes	Yes	Yes	Yes	Yes	Yes
	2462	11	Yes	Yes	Yes	Yes	Yes	Yes	Yes	Yes	Yes
	2467	12	-	-	Yes	Yes	Yes	Yes	Yes	Yes	Yes
	2472	13	-	-	Yes	Yes	Yes	Yes	Yes	Yes	Yes
	2484	14	-	-	-	-	-	Yes	-	-	-
5 GHz Band	5180	36	Yes	Yes	Yes	Yes	Yes	Yes	-	Yes	Yes
	5200	40	Yes	Yes	Yes	Yes	Yes	Yes	-	Yes	Yes
	5220	44	Yes	Yes	Yes	Yes	Yes	Yes	-	Yes	Yes
	5240	48	Yes	Yes	Yes	Yes	Yes	Yes	-	Yes	Yes
	5260	52	Yes	Yes	Yes	Yes	Yes	Yes	-	Yes	Yes
	5280	56	Yes	Yes	Yes	Yes	Yes	Yes	-	Yes	Yes
	5300	60	Yes	Yes	Yes	Yes	Yes	Yes	-	Yes	Yes
	5320	64	Yes	Yes	Yes	Yes	Yes	Yes	-	Yes	Yes
	5500	100	Yes	Yes	Yes	Yes	Yes	-	-	-	-
	5520	104	Yes	Yes	Yes	Yes	Yes	-	-	-	-
	5540	108	Yes	Yes	Yes	Yes	Yes	-	-	-	-
	5560	112	Yes	Yes	Yes	Yes	Yes	-	-	-	-
	5580	116	Yes	Yes	Yes	Yes	Yes	-	-	-	-
	5600	120	-	-	Yes	-	-	-	-	-	-
	5620	124	-	-	Yes	-	-	-	-	-	-
	5640	128	-	-	Yes	-	-	-	-	-	-
	5660	132	Yes	Yes	Yes	Yes	Yes	-	-	-	-
5680	136	Yes	Yes	Yes	Yes	Yes	-	-	-	-	
5700	140	Yes	Yes	Yes	Yes	Yes	-	-	-	-	

	Frequency	Channel	FCC/USA	Canada	Europe	Australia	New Zealand	Japan	China	Israel	Mexico
	5720	144	Yes	Yes	-	Yes	Yes	-	N/A	-	-
	5745	149	Yes	Yes	-	Yes	Yes	-	Yes	-	-
	5765	153	Yes	Yes	-	Yes	Yes	-	Yes	-	-
	5785	157	Yes	Yes	-	Yes	Yes	-	Yes	-	-
	5805	161	Yes	Yes	-	Yes	Yes	-	Yes	-	-
	5825	165	Yes	Yes	-	Yes	Yes	-	Yes	-	-

Table 10: 40 MHz Channels

	Frequency	Channel	FCC/USA	Canada	Europe	Australia	New Zealand	Japan	China	Israel	Mexico
5 GHz Band	5190	38	Yes	Yes	Yes	Yes	Yes	Yes	-	Yes	Yes
	5230	46	Yes	Yes	Yes	Yes	Yes	Yes	-	Yes	Yes
	5270	54	Yes	Yes	Yes	Yes	Yes	Yes	-	Yes	Yes
	5310	62	Yes	Yes	Yes	Yes	Yes	Yes	-	Yes	Yes
	5510	102	Yes	Yes	Yes	Yes	Yes	-	-	-	-
	5550	110	Yes	Yes	Yes	Yes	Yes	-	-	-	-
	5590	118	-	-	Yes	-	-	-	-	-	-
	5630	126	-	-	Yes	-	-	-	-	-	-
	5670	134	Yes	Yes	Yes	Yes	Yes	-	-	-	-
	5755	151	Yes	Yes	-	Yes	Yes	-	Yes	-	-
	5795	159	Yes	Yes	-	Yes	Yes	-	Yes	-	-

Table 11: 80 MHz Channels

	Frequency	Channel	FCC/USA	Canada	Europe	Australia	New Zealand	Japan	China	Israel	Mexico
5 GHz Band	5210	42	Yes	Yes	Yes	Yes	Yes	Yes	-	Yes	Yes
	5290	58	Yes	Yes	Yes	Yes	Yes	Yes	-	Yes	Yes
	5530	106	Yes	Yes	Yes	Yes	Yes	-	-	-	-
	5610	122	-	-	Yes	-	-	-	-	-	-
	5690	138	Yes	Yes	Yes	Yes	Yes	-	-	-	-
	5775	155	Yes	Yes	-	Yes	Yes	-	Yes	-	-

5: Antenna Connection Options

The PW20501 module supports wireless connectivity via the U.FL connector on the module for transmit and receive along with a second U.FL for receive diversity.

The PW20502 module offers an on-module ceramic chip antenna for transmit and receive along with a U.FL for connection to an additional antenna for receive diversity.

The PremierWave 2050 modules are certified using the antennas listed in [Table 12](#) and [Table 13](#) below.

Refer to the compliance section below for certification requirements related to antenna selection.

Table 12: PW20501 Module External Antenna Options

Antenna Type	Peak Gain Typical	Lantronix Part Number	Vendor	Vendor Part Number	Approved Region
PCB strip antenna with 50 mm cable to U.FL connector With tape backing	2.5 dBi, 2.39 Ghz to 2.49 Ghz 5dBi, 4.9Ghz to 5.9Ghz	XPW100A 003-01-B 50 piece bulk pack	Ethertronics	1001077	FCC, IC, EU, AUS/NZS, JPN, China, Mexico
PCB strip antenna with 50 mm cable to U.FL connector Without tape backing	2.5 dBi, 2.39 Ghz to 2.49 Ghz 5dBi, 4.9Ghz to 5.9Ghz		Ethertronics	1000668	FCC, IC, EU, AUS/NZS, JPN, China, Mexico
Swivel type antenna, with RP-SMA(M) connector	2 dBi, 2.4 Ghz to 2.5 Ghz, 2 dBi, 5.15 Ghz to 5.85 Ghz	930-033-R-ACC 50 piece bulk pack	Wanshih	WSS002	FCC, IC, EU, AUS/NZS, JPN, China, Mexico
Swivel type antenna, with RP-SMA(M) connector	3.8 dBi, 2.4Ghz to 2.5Ghz, 5.5 dBi, 4.9 Ghz to 5.8Ghz		Taoglas	GW.71.5153 (Not for EU use)	FCC, IC, AUS/NZS, JPN, China, Mexico

Table 13: PW20502 Module On-Module Antenna

Antenna Type	Peak Gain Typical
On module ceramic chip antenna	2.17 dBi 2.4Ghz to 2.5 Ghz 2.74 dBi, 4.9 to 5.8 Ghz

6: General Technical Data

Table 14: General Technical Data

Category	Description
Firmware	OTA upgradable
Internal Web Server	Serves web pages
Weight	0.0142 kilogram
Material	Metal shell
Temperature	Operating range: -40°C to +85°C (-40°F to +185°F) Storage range: -40°C to +85°C (-40°F to +185°F)
Relative Humidity	Operating: 5% to 85% no- condensing
Shock/Vibration	Non-operational shock: 500 g's. Non-operational vibration: 20 g's.
RAM	32 MB DDR2 DRAM
Flash	128 MB NAND flash

7: Electrical Characteristics

Recommended Operating Conditions

Table 15 specifies the recommended operation conditions and parameters for optimum performance of the PremierWave 2050 module.

Table 15: Recommended Operating Conditions for PremierWave 2050 Module

Parameter	Symbol	Min	Typ	Max	Units
Voltage	VCC	4.5	5.0	5.5	V DC
Supply Voltage Ripple	VCC pp			± 2%	
Extended Operating Temperature	T _a	-40		+85	°C
Humidity (non-condensing, relative)				85	%

DC Characteristics – Digital I/O Signals

Table 16: DC Characteristics – Digital I/O Signals

Symbol	Parameter/Signal	Conditions	Min	Typ	Max	Unit
VIL	RESET#	VCC=5V	-0.3	0	0.4	V
VIH	RESET#	VCC=5V			VCC	
VIL	WAKE, CP1-CP13, RXD1, RXD2, CTS1, CTS2, DBRX	VCC=5V	-0.3	0	0.8	V
VIH	WAKE, CP1-CP13, RXD1, RXD2, CTS1, CTS2, DBRX	VCC=5V	2		3.6	V
VOL	SHDN, CP1-CP13, TXD1, TXD2, RTS1, RTS2, DBTX	VCC=5V			0.4	V
VOH	SHDN, CP1-CP13, TXD1, TXD2, RTS1, RTS2, DBTX	VCC=5V	2.9		3.6	V
RPU/RP D	CP1-CP13, RXD1, RXD2, CTS1, CTS2, DEFAULT#, TXD1, TXD2, RTS1, RTS2	VIN=VSS	40	75	190	kΩ
RPU	CP5, CP6, DBRX			10		kΩ
RPU	WAKE			100		kΩ
RPU	RESET#			35		kΩ

Dynamic Power Management Modes

[Table](#) below describes the power management modes for the PremierWave 2050 module, along with their typical and maximum current consumption values.

The PremierWave 2050 module supports power-up and sleep modes within its dynamic power management framework.

Table 17: PremierWave 2050 Power Management Modes

Parameter	Symbol	Min	Typical	Max	Units
WLAN associated 5Ghz 802.11ac, Ethernet ping (average current).	I _{cc}		270		mA
WLAN associated 5Ghz 802.11ac, Ethernet ping (transmit surge)	I _{cc}		480		mA
WLAN iperf running 802.11ac, Ethernet linked (average current)	I _{cc}		370		mA
WLAN iperf running 802.11ac, Ethernet linked (transmit surge)	I _{cc}		490		mA
Boot sequence surge current	I _{cc}		540		mA
Boot sequence inrush	I _{cc}		930		mA

Output Power

PremierWave 2050 module RF output power is listed in the [Table 18](#) below

Table 18: PremierWave 2050 Module RF Output Power

Characteristics		TYP.	Criteria	Unit
RF Average Output Power, 802.11b (2.412 to 2.472 Ghz)	1 Mbps	16	± 2	dBm
	11 Mbps	16	± 2	dBm
RF Average Output Power, 802.11g (2.412 to 2.472 Ghz)	6 Mbps	14	± 2	dBm
	54 Mbps	14	± 2	dBm
RF Average Output Power, 802.11n (2.412 to 2.472 Ghz)	MCS0	13	± 2	dBm
	MCS7	13	± 2	dBm
RF Average Output Power, 802.11a (5.18 to 5.825 Ghz)	6 Mbps	14	± 2	dBm
	54 Mbps	14	± 2	dBm

Characteristics		TYP.	Criteria	Unit
RF Average Output Power, 802.11n (5.18 to 5.825 GHz)	MCS0	13	± 2	dBm
	MCS7	13	± 2	dBm
RF Average Output Power, 802.11ac (5.18 to 5.825 GHz)	MCS8	13	± 2	dBm
	MCS9	11	± 2	dBm

Power, Reset, Wake, Shutdown and Default Timing

The diagrams below show the timing requirement for VCC, RESET#, DEFAULT#, WAKE and SHDN.

Figure 6 Reset Timing

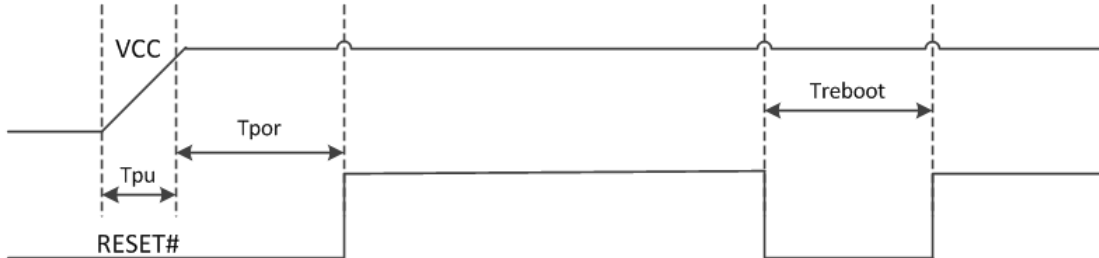

Figure 7 Reset to Defaults Timing

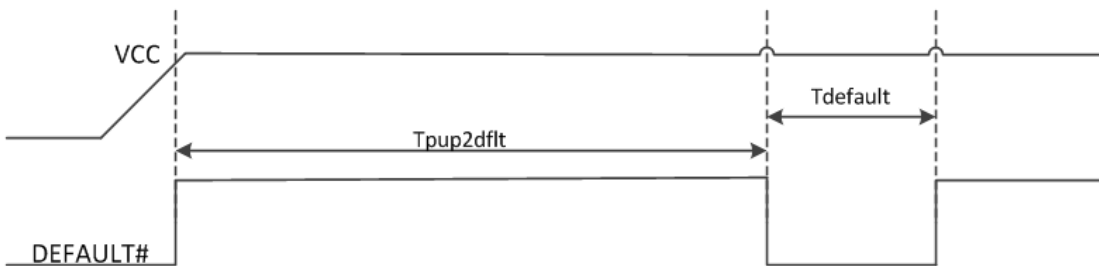

Figure 8 Wake Timing

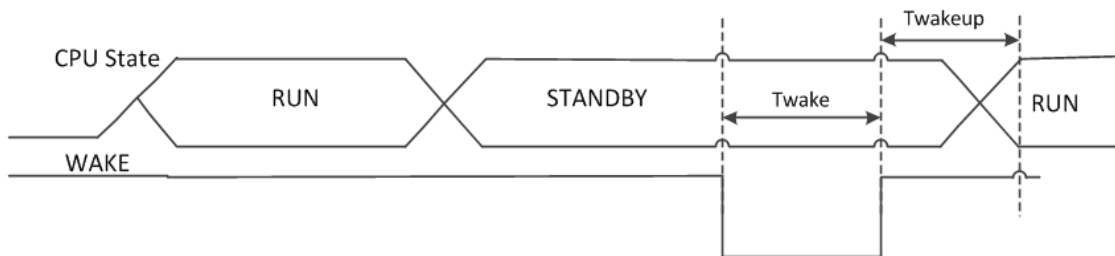
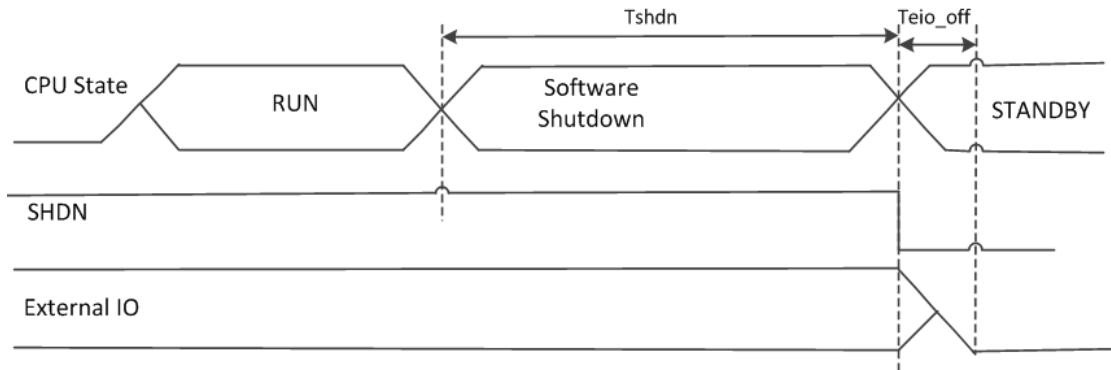

Figure 9 Shutdown Pin Timing



Parameter	Description	Minimum	Maximum	Unit
T_{pu}	Time for VCC to reach 90% of its maximum value	20		us/V
T_{por}	Time from VCC to reach 90% of its maximum value and de-assertion of external reset. Note RESET# can be left floating if unused	0		S
T_{reboot}	Recommended reset pulse for system reboot	50		ms
$T_{pup2dfilt}$	Time from VCC power up to DEFAULT# assertion. Note DEFAULT# can be left floating if unused.	0		ns
$T_{default}$	Assertion time for DEFAULT# to unit reset to default and reboot.	6		S
T_{wake}	Wake pulse width. Note wakeup is triggered on the rising edge. Note, WAKE signal may be left floating if unused.	1		us
T_{eio_off}	Time recommended to shut off external IO to prevent leakage into module		1	ms

EVM

PremierWave 2050 module TX EVM follow the IEEE specification listed in [Table 19](#) below.

Table 19: PremierWave 2050 Module Wi-Fi EVM

Characteristics		EVM Value MAX	Unit
RF Average Output EVM (11g)	6 Mbps	-5	dB
	54 Mbps	-25	dB
RF Average Output EVM (11n 2.4Ghz)	MCS0	-5	dB
	MCS7	-27	dB
RF Average Output EVM (11a)	6 Mbps	-5	dB
	54 Mbps	-25	dB

Characteristics		EVM Value MAX	Unit
RF Average Output EVM (11n 5Ghz)	MCS0	-5	dB
	MCS7	-27	dB
RF Average Output EVM (11ac)	MCS8(HT20)	-30	dB
	MCS9(HT80)	-32	dB

Receive Sensitivity

PremierWave 2050 module Rx sensitivity is listed in [Table 20](#) below.

Table 20: PremierWave 2050 Module Rx Sensitivity

Receiver Characteristics	TYP.	MAX.
PER <8%, Rx Sensitivity @ 802.11b 1 Mbps	-96	-82
PER <8%, Rx Sensitivity @ 802.11b 11 Mbps	-89	-76
PER <10%, Rx Sensitivity @ 802.11g 6 Mbps	-93	-82
PER <10%, Rx Sensitivity @ 802.11g 54 Mbps	-76	-65
PER <10%, Rx Sensitivity @ 802.11n 2.4Ghz MCS0	-93	-82
PER <10%, Rx Sensitivity @ 802.11n 2.4Ghz MCS7	-74	-64
PER <10%, Rx Sensitivity @ 802.11a 6 Mbps	-92	-82
PER <10%, Rx Sensitivity @ 802.11a 54 Mbps	-76	-65
PER <10%, Rx Sensitivity @ 802.11n 5Ghz MCS0	-92	-82
PER <10%, Rx Sensitivity @ 802.11n 5Ghz MCS7	-74	-64
PER <10%, Rx Sensitivity @ 802.11ac MCS8 HT20	-70	-59
PER <10%, Rx Sensitivity @ 802.11ac MCS9 HT80	-62	-51

Memory

The PremierWave 2050 module comes with the following memory profile:

Flash Memory

The PremierWave 2050 module has 1 Gbit (128 Mbyte) NAND flash that is shared between the boot, OS, and user space

DRAM

The PremierWave 2050 module has 512 Mbit (64 Mbyte) DRAM

8: Package Description and Mechanical Footprint

The PremierWave 2050 module is available in two package options: PW20501 and PW20502 models. These modules are both surface mount modules which have the following dimensions and pad layout pictured below. The primary difference is the PW20502 module has an on-module antenna while the PW20501 uses an external antenna that connects to a U.FL connector on the module. Both devices have the same LGA and pad configuration and footprint.

Dimensions

The size and thickness of the PW20501 module is 46.66 mm (L) x 41.44 mm (W) x 3.50 mm (H) +/- 0.3 mm (including shielding). The PCB footprint is shown in the figure on the next page.

Figure 10 PW20502 Enterprise Wi-Fi IoT Wi-Fi Module

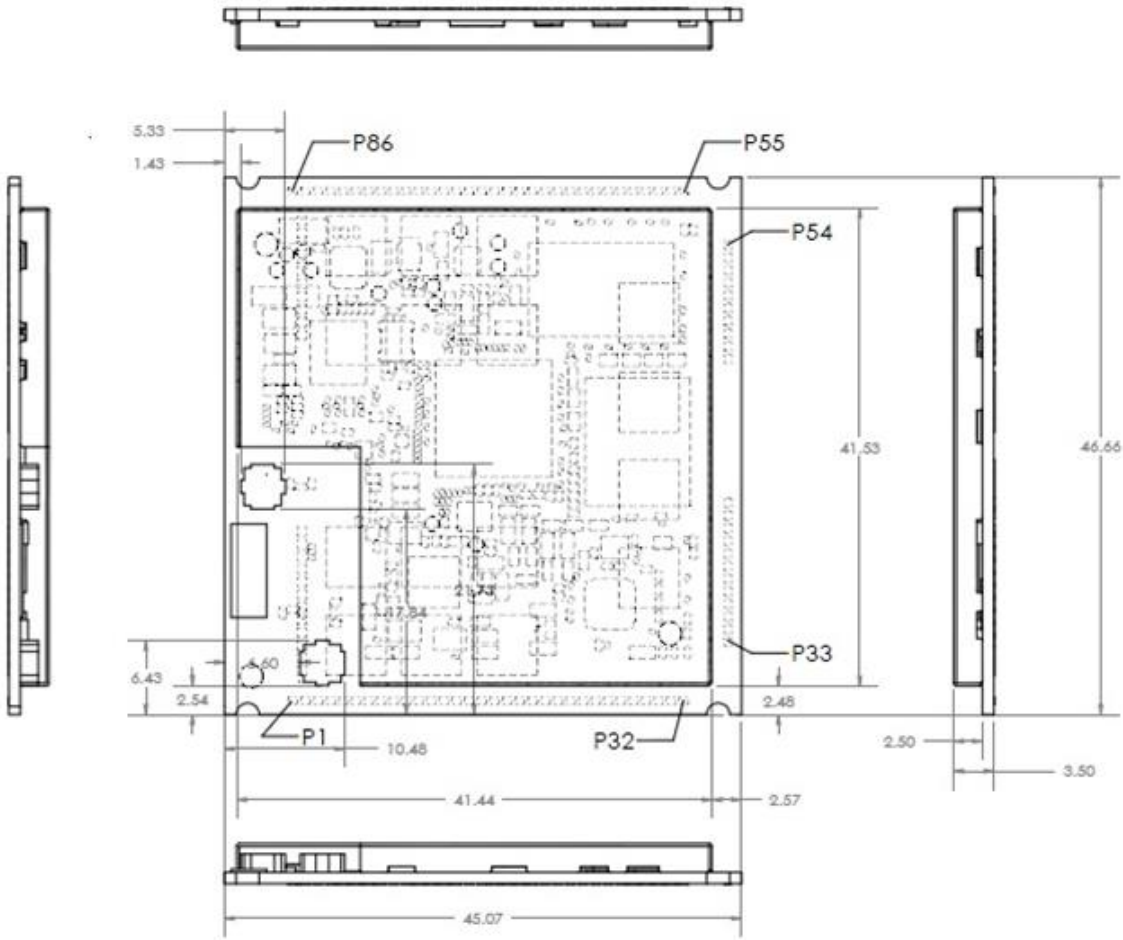
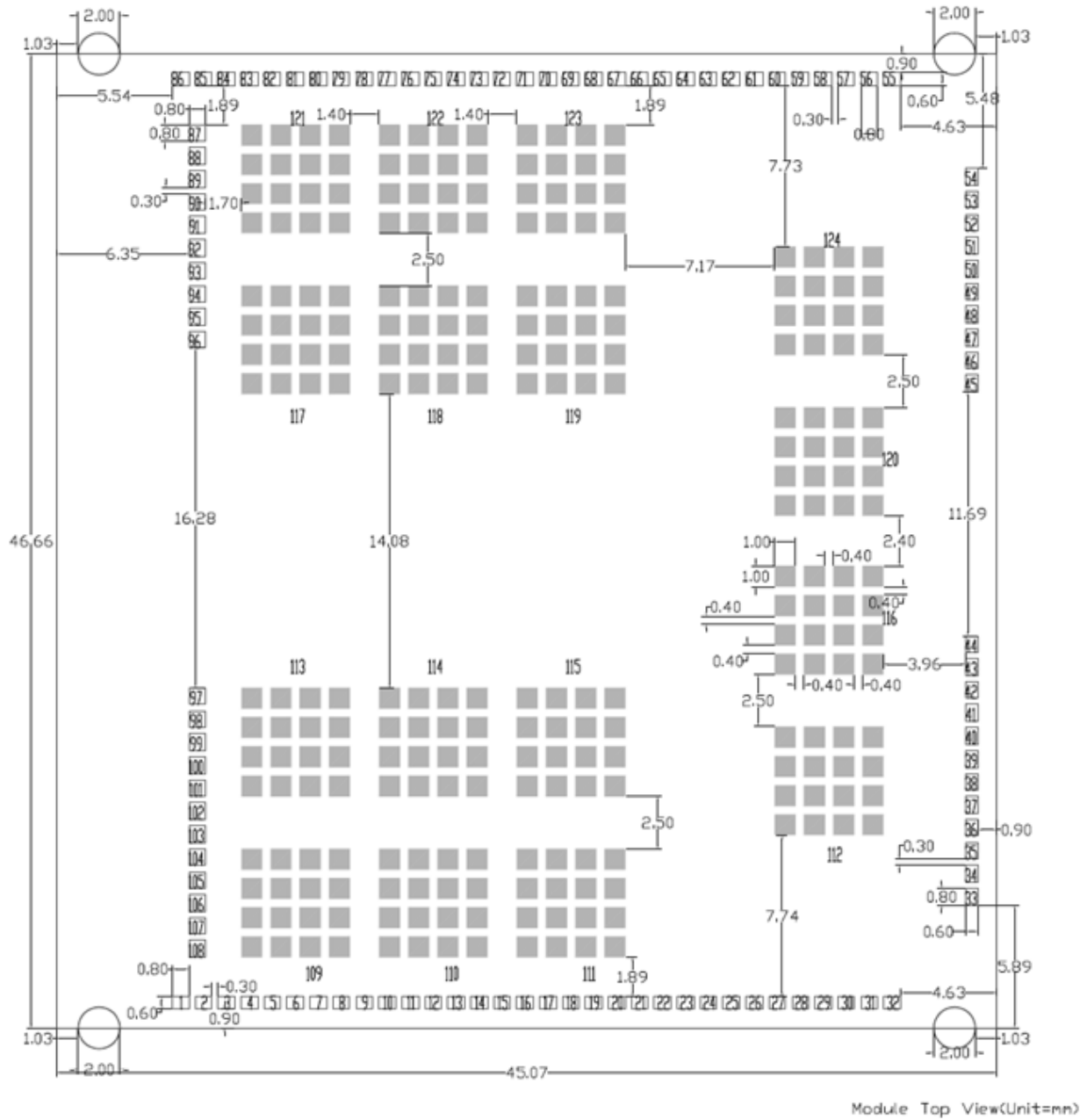

Figure 11 Layout Footprint for PremierWave 2050 Enterprise Wi-Fi IoT Module



Pin and Pad Definitions

Table 21 describes the PremierWave 2050 Wi-Fi interface signal definitions as used in the modules. The **Signal Name** column identifies the signal pin being described while the **Primary Function** column provides definitions of the signal pin depending upon the member of the PremierWave 2050 family being used. Differentiating the signal pins is beneficial when using multiple PremierWave 2050 device types on a single platform.

Table 21: PremierWave 2050 Interface Signal Definitions:

Signal Name	PremierWave 2050 Pin #	Primary Function	Reset State	Internal Pull-up /Pull-down	Driver Strength
RF1	2	RF signal to PCB trace when RF1_CTL is asserted low (future module versions only)			
RF2	4	RF signal to PCB trace when RF1_CTL is asserted low (future module versions only)			
CP3/MISO	12	Configurable GPIO / SPI master serial data input, SPI slave serial data output	Input PU	70K PU	4 mA
CP4/MOSI	13	Configurable GPIO / SPI master serial data output, SPI slave serial data input	Input PU	70K PU	4 mA
CP7/SCK	14	Configurable GPIO / SPI clock	Input PU	70K PU	4 mA
CP8/CS	15	Configurable GPIO, multiplexed with SPI interface chip select	Input PU	70K PU	4 mA
CP5	16	Configurable GPIO / I2C data	Input PU	10K PU	4 mA
CP6	17	Configurable GPIO / I2C clock	Input PU	10K PU	4 mA
USB1+/DDP	18	USB (Positive) USB high speed host/device port			
USB1-/DDM	19	USB (Negative) USB high speed host/device port			
USB2+	21	USB (Positive) USB high speed host port			
USB2-	22	USB (Negative) USB high speed host port			
RTS2	24	UART2 serial ready to send output	Input PU	70K PU	4 mA

Signal Name	PremierWave 2050 Pin #	Primary Function	Reset State	Internal Pull-up /Pull-down	Driver Strength
CTS2	25	UART2 clear to send input	Input PU	70K PU	
CP9	26	Configurable GPIO	Input PU	70K PU	4 mA
DBTX	27	Debug UART serial transmit data output	Output		4 mA
DBRX	28	Debug UART serial receive data input	Input PU	10K PU	
ETXP (ETH1+)	34	Ethernet TX (positive) Future Gbit pair 1 (pos)			
ETXM (ETH1-)	35	Ethernet TX (negative) Future Gbit pair 1 (net)			
TXCT (ECT1)_	37	Center tap connection for Ethernet TX pair			
RXCT (ECT2)	38	Center tap connection for Ethernet RX pair			
ERXP (ETH2+)	40	Ethernet RX (positive) Future Gbit pair 2 (pos)			
ERXM (ETH2-)	41	Ethernet RX (negative) Future Gbit pair 2 (neg)			
ETH3+	43	Reserved for future Gbit Ethernet pair 3 (positive)			
ETH3-	44	Reserved for future Gbit Ethernet pair 3 (negative)			
ETH4+	46	Reserved for future Gbit Ethernet pair 4 (positive)			
ETH4-	47	Reserved for future Gbit Ethernet pair 4 (negative)			
ECT3	49	Reserved for future Gbit center tap 3 connection			
ECT4	50	Reserved for future Gbit center tap 4 connection			
USB3+	52	USB (positive) USB full speed host port			
USB3-	53	USB (negative)			

Signal Name	PremierWave 2050 Pin #	Primary Function	Reset State	Internal Pull-up /Pull-down	Driver Strength
		USB full speed host port			
SPEED_LED	56	Ethernet speed LED, active low for 100Mbps	Output Open Drain		32 mA
CP13	57	Configurable GPIO	Input PU	70K PU	4 mA
CP12	58	Configurable GPIO	Input PU	70K PU	4 mA
CP11	59	Configurable GPIO	Input PU	70K PU	4 mA
CP10	60	Configurable GPIO	Input PU	70K PU	4 mA
WAKE	65	CPU Wake up input. Module wakes from low power state on a rising edge. Use an open drain driver to control WAKE.	Input	100K PU	
DEFAULT#	66	Unit reset to default, active low. Drive low for 7 seconds to reset unit to default settings.	Input PU	70K PU	
SYS_LED	67	System status LED, active high	Input PU	70K PU	4 mA
CP2/INT	68	Configurable GPIO / SPI interrupt External interrupt input	Input PU	70K PU	4 mA
CP1	71	Configurable GPIO	Input PU	70K PU	4 mA
LINK_ACT	72	Ethernet link/activity LED Active low for link. Toggle for activity.	Output Open Drain		32 mA
WLAN LED	73	LED function for WLAN Link indication, active low	Input PU	70K PU	4 mA
RESET#	77	Unit hardware reset, active low. Drive low to reboot unit. Use an open drain driver to control RESET#	Input	35K PU	
RXD2	78	UART2 serial receive data input	Input PU	70K PU	
TXD2	79	UART2 serial transmit data output	Input PU	70K PU	4 mA

Signal Name	PremierWave 2050 Pin #	Primary Function	Reset State	Internal Pull-up /Pull-down	Driver Strength
CTS1	80	UART1 clear to send input	Input PU	70K PU	
RTS1	81	UART1 serial ready to send output	Input PU	70K PU	4 mA
RXD1	82	UART1 Serial receive data input	Input PU	70K PU	
TXD1	83	UART1 serial transmit data output	Input PU	70K PU	4 mA
SHDN	88	Indicates when module is in standby state. Use to power off external devices when asserted low	Output Push Pull		
RF1_CTL	97	Antenna Switch control. Pull low to select an external antenna connected to the RF1 pad (pin 2) and RF2 pad (pin 4). This is for a future module revision. Leave disconnected			
TRST	100	TRST signal for external debugger	Input	100K PU	
TDO	101	TDO signal for external debugger	Output		
TDI	104	TDI signal for external debugger	Input	100K PU	
TCK	105	TCK signal for external debugger	Input	100K PU	
TMS	106	TMS signal for external debugger	Input	100K PU	
VCC	29,30,31	5V power input			
GND	1,3,5,20,23,32, 33,36,39,42,45, 48,51,54,55,61, 64,84,86,87,94, 95,96,98,99,102, 103,107,108,109, 110,111,112,113, 114,115,116,117, 118,119,120,121, 122,123,124	Signal ground			

Signal Name	PremierWave 2050 Pin #	Primary Function	Reset State	Internal Pull-up /Pull-down	Driver Strength
RSVD	2,4,6,7,8,9,10,11, 43,44,46,47,49,50, 62,63,69,70,74, 75,76,85,89,90, 91,92,93,97	Reserved for future use. Leave disconnected.			

Note1: The current module supports 10/100 Mbps Ethernet. Additional pins have been called out for a future Gigabit Ethernet module.

Note2: The logic IO pins are 3.3V tolerant.

Note3: Pins 109 to 124 are the large ground pads under the module. These pads should be connected to ground. These pads also provide thermal relief for the module. It is recommended that multiple vias for each pad be used to connect the ground pads to the ground plane.

9: Product Information Label

The product information label contains important information about your specific module, including the part number, revision, manufacturing date code, product model, country of origin, datamatrix barcode, and MAC address.

Figure 12 PremierWave 2050 Module Label



The relationship between the Part Number, used when ordering products, and the Manufacturer Part Number, located on the product label, is described in chapter 12: Ordering Information.

The PremierWave 2050 module uses the Datamatrix ECC200 barcode standard. The field definitions are as follows:

Table 22: Datamatrix ECC200 Barcode Standard Field Definitions

Field	Description	Example
V1	Barcode format revision	1
C1	Field count.	6
P1	Part number of the module	PWGG2051000
R1	Revision of the module	A11
D1	Manufacturing datecode of the module	14W20
L1	Country and factory ID# of manufacturer	CHINA 03
S1	Serial number	0080A3980404
M1	MAC address	0080A3980404
M2	MAC address 2	0080A3980511
E1	End of barcode	

10: Evaluation Kit

A PremierWave 2050 module evaluation kit is available to provide a simple, quick and cost effective way to evaluate the PremierWave 2050 module. Use the evaluation kit to integrate the module into to your product design and find out how simple, easy it is to get started.

- ◆ The PWGG2051000K, is a single board with the PW20501 module mounted.
- ◆ The PWGG2052000K, is a single board with the PW20502 module mounted.

This allows the simple use of the module and use of the on-module antenna version. The evaluation board includes the necessary keep out areas, so performance and positioning can be evaluated.

11: Compliance

(According to ISO/IEC Guide and EN 45014)

Manufacturer's Name & Address:

Lantronix, Inc.

7535 Irvine Center Drive, Suite 100, Irvine, CA 92618 USA

Declares that the following product:

Product Name Model: PremierWave 2050 Enterprise Wi-Fi IoT Module

Conforms to the following standards or other normative documents:

Table 23: Country Certifications



Country	Specification
USA 	FCC Part 15, Subpart B, Class B FCC Part 15, Subpart C 15.247 (WLAN) FCC Part 15, Subpart C 15.247 (BT) FCC Part 15, Subpart E 15.407 (DFS)
Canada	ICES-003:2012 Issue 5, Class B RSS-Gen, Issue 4, November 2014 RSS-102, Issue 5, March 2015 RSS-247, Issue 1, May 2015
Mexico	NOM-121-SCT1-2009
Australia, New Zealand  N11206	AS/NZS 4268: A1: 2013 AS/NZS 2772.2
Japan	ARIB STD-T66 (v3.7), MIC notice 88 Appendix 43 RCR STD-33 (v5.4), MIC notice 88 Appendix 44 ARIB STD-T71(v6.1), MIC notice 88 Appendix 45
China SRRC	CMIIT ID: 2015AJ6847 (M)

Table 24: Country Transmitter IDs

Country	Specification
USA FCC ID	R68PW2050
Canada IC ID	3867A-PW2050
Mexico	RCPLAPW15-2109
Japan ID	201-152843
China SRRC	2015AJ6847 (M)

Table 25: Safety

Country	Specification
World Wide 	CB EN 60950-1:2006 + A11:2009 + A1:2010 + A12:2011 +A2:2013 In accordance with the council directive 2006/95/EC
US, Canada	UL 60950-1 (2nd Edition)

Federal Communication Commission Interference Statement

This device complies with Part 15 of the FCC Rules. Operation is subject to the following two conditions: (1) This device may not cause harmful interference, and (2) this device must accept any interference received, including interference that may cause undesired operation.

This equipment has been tested and found to comply with the limits for a Class B digital device, pursuant to Part 15 of the FCC Rules. These limits are designed to provide reasonable protection against harmful interference in a residential installation. This equipment generates, uses, and can radiate radio frequency energy and, if not installed and used in accordance with the instructions, may cause harmful interference to radio communications. However, there is no guarantee that interference will not occur in a particular installation. If this equipment does cause harmful interference to radio or television reception, which can be determined by turning the equipment off and on, the user is encouraged to try to correct the interference by one of the following measures:

- ◆ Reorient or relocate the receiving antenna.
- ◆ Increase the separation between the equipment and receiver.
- ◆ Connect the equipment into an outlet on a circuit different from that to which the receiver is connected.
- ◆ Consult the dealer or an experienced radio/TV technician for help.

FCC Caution: Any changes or modifications not expressly approved by the party responsible for compliance could void the user's authority to operate this equipment.

This transmitter must not be co-located or operating in conjunction with any other antenna or transmitter.

Operations in the 5.15-5.25GHz band are restricted to indoor usage only.

Radiation Exposure Statement:

This equipment complies with FCC radiation exposure limits set forth for an uncontrolled environment. This equipment should be installed and operated with minimum distance 20cm between the radiator & your body.

This device is intended only for OEM integrators under the following conditions:

- 1) The antenna must be installed such that 20 cm is maintained between the antenna and users, and
- 2) The transmitter module may not be co-located with any other transmitter or antenna.

As long as 2 conditions above are met, further transmitter test will not be required. However, the OEM integrator is still responsible for testing their end-product for any additional compliance requirements required with this module installed.

IMPORTANT NOTE: *In the event that these conditions can not be met (for example certain laptop configurations or colocation with another transmitter), then the FCC authorization is no longer considered valid and the FCC ID can not be used on the final product. In these circumstances, the OEM integrator will be responsible for re-evaluating the end product (including the transmitter) and obtaining a separate FCC authorization.*

End Product Labeling

This transmitter module is authorized only for use in device where the antenna may be installed such that 20 cm may be maintained between the antenna and users. The final end product must be labeled in a visible area with the following: "Contains FCC ID: R68PW2050". The grantee's FCC ID can be used only when all FCC compliance requirements are met.

Manual Information To the End User

The OEM integrator has to be aware not to provide information to the end user regarding how to install or remove this RF module in the user's manual of the end product which integrates this module.

The end user manual shall include all required regulatory information/warning as show in this manual.

Industry Canada statement:

This device complies with RSS-247 of the Industry Canada Rules. Operation is subject to the following two conditions: (1) This device may not cause harmful interference, and (2) this device must accept any interference received, including interference that may cause undesired operation.

Ce dispositif est conforme à la norme CNR-247 d'Industrie Canada applicable aux appareils radio exempts de licence. Son fonctionnement est sujet aux deux conditions suivantes: (1) le dispositif ne doit pas produire de brouillage préjudiciable, et (2) ce dispositif doit accepter tout brouillage reçu, y compris un brouillage susceptible de provoquer un fonctionnement indésirable.

Radiation Exposure Statement:

This equipment complies with IC radiation exposure limits set forth for an uncontrolled environment. This equipment should be installed and operated with minimum distance 20cm between the radiator & your body.

Déclaration d'exposition aux radiations:

Cet équipement est conforme aux limites d'exposition aux rayonnements IC établies pour un environnement non contrôlé. Cet équipement doit être installé et utilisé avec un minimum de 20 cm de distance entre la source de rayonnement et votre corps.

This device is intended only for OEM integrators under the following conditions: (For module device use)

- 1) The antenna must be installed such that 20 cm is maintained between the antenna and users, and
- 2) The transmitter module may not be co-located with any other transmitter or antenna.

As long as 2 conditions above are met, further transmitter test will not be required. However, the OEM integrator is still responsible for testing their end-product for any additional compliance requirements required with this module installed.

Cet appareil est conçu uniquement pour les intégrateurs OEM dans les conditions suivantes: (Pour utilisation de dispositif module)

- 1) L'antenne doit être installée de telle sorte qu'une distance de 20 cm est respectée entre l'antenne et les utilisateurs, et
- 2) Le module émetteur peut ne pas être coïmplanté avec un autre émetteur ou antenne.

Tant que les 2 conditions ci-dessus sont remplies, des essais supplémentaires sur l'émetteur ne seront pas nécessaires. Toutefois, l'intégrateur OEM est toujours responsable des essais sur son produit final pour toutes exigences de conformité supplémentaires requis pour ce module installé.

IMPORTANT NOTE:

In the event that these conditions can not be met (for example certain laptop configurations or co-location with another transmitter), then the Canada authorization is no longer considered valid and the IC ID can not be used on the final product. In these circumstances, the OEM integrator will be responsible for re-evaluating the end product (including the transmitter) and obtaining a separate Canada authorization.

NOTE IMPORTANTE:

Dans le cas où ces conditions ne peuvent être satisfaites (par exemple pour certaines configurations d'ordinateur portable ou de certaines co-localisation avec un autre émetteur), l'autorisation du Canada n'est plus considéré comme valide et l'ID IC ne peut pas être utilisé sur le produit final. Dans ces circonstances, l'intégrateur OEM sera chargé de réévaluer le produit final (y compris l'émetteur) et l'obtention d'une autorisation distincte au Canada.

End Product Labeling

This transmitter module is authorized only for use in device where the antenna may be installed such that 20 cm may be maintained between the antenna and users. The final end product must be labeled in a visible area with the following: "Contains IC: 3867A-PW2050".

Plaque signalétique du produit final

Ce module émetteur est autorisé uniquement pour une utilisation dans un dispositif où l'antenne peut être installée de telle sorte qu'une distance de 20cm peut être maintenue entre l'antenne et les utilisateurs. Le produit final doit être étiqueté dans un endroit visible avec l'inscription suivante: "Contient des IC: 3867A-PW2050".

Manual Information To the End User

The OEM integrator has to be aware not to provide information to the end user regarding how to install or remove this RF module in the user's manual of the end product which integrates this module.

The end user manual shall include all required regulatory information/warning as show in this manual.

Manuel d'information à l'utilisateur final

L'intégrateur OEM doit être conscient de ne pas fournir des informations à l'utilisateur final quant à la façon d'installer ou de supprimer ce module RF dans le manuel de l'utilisateur du produit final qui intègre ce module.

Le manuel de l'utilisateur final doit inclure toutes les informations réglementaires requises et avertissements comme indiqué dans ce manuel.

Caution :

(i) the device for operation in the band 5150-5250 MHz is only for indoor use to reduce the potential for harmful interference to cochannel mobile satellite systems;

(ii) the maximum antenna gain permitted for devices in the bands 5250-5350 MHz and 5470-5725 MHz shall be such that the equipment still complies with the e.i.r.p. limit;

(iii) the maximum antenna gain permitted for devices in the band 5725-5850 MHz shall be such that the equipment still complies with the e.i.r.p. limits specified for point-to-point and non-point-to-point operation as appropriate; and

(iv) Users should also be advised that high-power radars are allocated as primary users (i.e. priority users) of the bands 5250-5350 MHz and 5650-5850 MHz and that these radars could cause interference and/or damage to LE-LAN devices.

Avertissement:

Le guide d'utilisation des dispositifs pour réseaux locaux doit inclure des instructions précises sur les restrictions susmentionnées, notamment :

(i) les dispositifs fonctionnant dans la bande 5150-5250 MHz sont réservés uniquement pour une utilisation à l'intérieur afin de réduire les risques de brouillage préjudiciable aux systèmes de satellites mobiles utilisant les mêmes canaux;

(ii) le gain maximal d'antenne permis pour les dispositifs utilisant les bandes de 5250 à 5350 MHz et de 5470 à 5725 MHz doit être conforme à la limite de la p.i.r.e.;

(iii) le gain maximal d'antenne permis (pour les dispositifs utilisant la bande de 5725 à 5850 MHz) doit être conforme à la limite de la p.i.r.e. spécifiée pour l'exploitation point à point et l'exploitation non point à point, selon le cas;

(iv) De plus, les utilisateurs devraient aussi être avisés que les utilisateurs de radars de haute puissance sont désignés utilisateurs principaux (c.-à-d., qu'ils ont la priorité) pour les bandes 5250-5350 MHz et 5650-5850 MHz et que ces radars pourraient causer du brouillage et/ou des dommages aux dispositifs LAN-EL.

Europe – EU Declaration of Conformity

The PremierWave 2050 embedded device server has been so constructed that the product complies with the requirement of with Article 10(2) as it can be operated in at least one Member State as examined and the product is compliant with Article 10(10) as it has no restrictions on putting into service in all EU member states.



Figure 13 EU Declaration of Conformity



7535 Irvine Center Drive, Suite 100, Irvine, CA 92618

EU DECLARATION OF CONFORMITY

This declaration of conformity is issued under the sole responsibility of the manufacturer.

Object of the declaration			
Product Information	Product Name: PremierWave 2050		
	Model	SW Version (Radio FW)	HW Version
	PW 2050	6.37.42.9	11 (or later)
<p>The object of the declaration described above is in conformity with the relevant Union harmonisation legislation:</p> <ul style="list-style-type: none"> •References to the relevant harmonised standards used or references to the technical specifications in relation to which conformity is declared 			
Radio Equipment Directive 2014/53/EU			
EN 300 328 V2.1.1			
EN 301 489-1 V2.1.1			
EN 301 489-17 V3.1.1			
EN 301 893-1 V2.1.1			
EN 62311:2008			
EN 60950-1:2006 + A1:2010 +A12:2011 +A2:2013			

The notified body, TUV SUD BABT, performed a conformity assessment of the technical construction file and issued certificate BABT-RED000307 i02.01.

Signature: Daryl R. Miller Date: 8-29-17

Name: Daryl R. Miller
Title: VP of Engineering, Lantronix, Inc.

Table 26: Europe – EU Declaration of Conformity

cs Český [Czech]	Lantronix tímto prohlašuje, že tento PremierWave 2050 enterprise Wi-Fi IoT module je ve shodě se základními požadavky a dalšími příslušnými ustanoveními směrnice RED 2014/53/EU.
da Dansk [Danish]	Undertegnede Lantronix erklærer herved, at følgende udstyr PremierWave 2050 enterprise Wi-Fi IoT module overholder de væsentlige krav og øvrige relevante krav i direktiv RED 2014/53/EU.
de Deutsch [German]	Hiermit erkläre Lantronix, dass sich das Gerät PremierWave 2050 enterprise Wi-Fi IoT module in Übereinstimmung mit den grundlegenden Anforderungen und den übrigen einschlägigen Bestimmungen der Richtlinie RED 2014/53/EU.
et Eesti [Estonian]	Käesolevaga kinnitab Lantronix seadme PremierWave 2050 enterprise Wi-Fi IoT module vastavust direktiivi RED 2014/53/EU põhinõuetele ja nimetatud direktiivist tulenevatele teistele asjakohastele sätetele.
en English	Hereby, Lantronix, declares that this PremierWave 2050 enterprise Wi-Fi IoT module is in compliance with the essential requirements and other relevant provisions of Directive RED 2014/53/EU.
es Español [Spanish]	Por medio de la presente Lantronix declara que el PremierWave 2050 enterprise Wi-Fi IoT module cumple con los requisitos esenciales y cualesquiera otras disposiciones aplicables o exigibles de la Directiva RED 2014/53/EU.
el Ελληνική [Greek]	ΜΕ ΤΗΝ ΠΑΡΟΥΣΑ Lantronix ΔΗΛΩΝΕΙ ΟΤΙ PremierWave 2050 enterprise Wi-Fi IoT module ΣΥΜΜΟΡΦΩΝΕΤΑΙ ΠΡΟΣ ΤΙΣ ΟΥΣΙΩΔΕΙΣ ΑΠΑΙΤΗΣΕΙΣ ΚΑΙ ΤΙΣ ΛΟΙΠΕΣ ΣΧΕΤΙΚΕΣ ΔΙΑΤΑΞΕΙΣ ΤΗΣ ΟΔΗΓΙΑΣ RED 2014/53/EU.
fr Français [French]	Par la présente Lantronix déclare que l'appareil PremierWave 2050 enterprise Wi-Fi IoT module est conforme aux exigences essentielles et aux autres dispositions pertinentes de la directive RED 2014/53/EU.
it Italiano [Italian]	Con la presente Lantronix dichiara che questo PremierWave 2050 enterprise Wi-Fi IoT module è conforme ai requisiti essenziali ed alle altre disposizioni pertinenti stabilite dalla direttiva RED 2014/53/EU.
Latviski [Latvian]	Ar šo Lantronix deklarē, ka PremierWave 2050 enterprise Wi-Fi IoT module atbilst Direktīvas RED 2014/53/EU būtiskajām prasībām un citiem ar to saistītajiem noteikumiem.
Lietuvių [Lithuanian]	Šiuo Lantronix deklaruoja, kad šis PremierWave 2050 enterprise Wi-Fi IoT module atitinka esminius reikalavimus ir kitas RED 2014/53/EU Direktyvos nuostatas.
nl Nederlands [Dutch]	Hierbij verklaart Lantronix dat het toestel PremierWave 2050 enterprise Wi-Fi IoT module in overeenstemming is met de essentiële eisen en de andere relevante bepalingen van richtlijn RED 2014/53/EU.
mt Malti [Maltese]	Hawnhekk, Lantronix, jiddikjara li dan PremierWave 2050 enterprise Wi-Fi IoT module jikkonforma malħtiġijiet essenzjali u ma provvedimenti oħrajn relevanti li hemm fid-Dirrettiva RED 2014/53/EU.
hu Magyar [Hungarian]	Alulírott, Lantronix nyilatkozom, hogy a PremierWave 2050 enterprise Wi-Fi IoT module megfelel a vonatkozó alapvető követelményeknek és az RED 2014/53/EU irányelv egyéb előírásainak.
pl Polski [Polish]	Niniejszym Lantronix oświadcza, że PremierWave 2050 enterprise Wi-Fi IoT module jest zgodny z zasadniczymi wymogami oraz pozostałymi stosownymi postanowieniami Dyrektywy RED 2014/53/EU.
pt Português [Portuguese]	Lantronix declara que este PremierWave 2050 enterprise Wi-Fi IoT module está conforme com os requisitos essenciais e outras disposições da Directiva RED 2014/53/EU.
sl Slovensko [Slovenian]	Lantronix izjavlja, da je ta PremierWave 2050 enterprise Wi-Fi IoT module v skladu z bistvenimi zahtevami in ostalimi relevantnimi določili direktive RED 2014/53/EU.

Slovensky [Slovak]	Lantronix týmto vyhlasuje, že PremierWave 2050 enterprise Wi-Fi IoT module spĺňa základné požiadavky a všetky príslušné ustanovenia Smernice RED 2014/53/EU.
fi Suomi [Finnish]	Lantronix vakuuttaa täten että PremierWave 2050 enterprise Wi-Fi IoT module tyyppinen laite on direktiivin RED 2014/53/EU oleellisten vaatimusten ja sitä koskevien direktiivin muiden ehtojen mukainen.
sv Svenska [Swedish]	Härmed intygar Lantronix att denna PremierWave 2050 enterprise Wi-Fi IoT module står i överensstämmelse med de väsentliga egenskapskrav och övriga relevanta bestämmelser som framgår av direktiv RED 2014/53/EU.

查詢 NB no.

<http://ec.europa.eu/enterprise/newapproach/nando/index.cfm?fuseaction=notifiedbody.main>

Table 27: Approved External Antenna(s) List

Antenna Type	Peak Gain Typical	Lantronix Part Number	Vendor	Vendor Part Number	Approved Region
PCB Strip Antenna with 50 mm cable to U.FL connector With tape backing	2.5dBi, 2.39 Ghz to 2.49 Ghz 5dBi, 4.9Ghz to 5.9Ghz	XPW100A 003-01-B 50 piece bulk pack	Ethertronics®	1001077	FCC, IC, EU, AUS/NZS, JPN, China, Mexico
PCB Strip Antenna with 50 mm cable to U.FL connector Without tape backing	2.5dBi, 2.39 Ghz to 2.49 Ghz 5dBi, 4.9Ghz to 5.9Ghz		Ethertronics	1000668	FCC, IC, EU, AUS/NZS, JPN, China, Mexico
Swivel type antenna, with RP-SMA(M) connector	2 dBi, 2.4 Ghz to 2.5 Ghz, 2 dBi, 5.15 Ghz to 5.85 Ghz	930-033-R-ACC 50 piece bulk pack	Wanshih	WSS002	FCC, IC, EU, AUS/NZS, JPN, China, Mexico
Swivel type antenna, with RP-SMA(M) connector	3.8 dBi, 2.4Ghz to 2.5Ghz, 5.5 dBi, 4.9 Ghz to 5.8Ghz		Taoglas	GW.71.5153 (Not for EU use)	FCC, IC, AUS/NZS, JPN, China, Mexico

Manufacturer's Contact:

Lantronix, Inc.
7535 Irvine Center Drive
Suite 100
Irvine, CA 92618 USA
Tel: 949-453-3990
Fax: 949-453-3995

RoHS, REACH, and WEEE Compliance Statement

Please visit <http://www.lantronix.com/legal/rohs/> for Lantronix's statement about RoHS, REACH and WEEE compliance.

12: Ordering Information

In the table below, the Part Number is used for ordering, and the Manufacturer Part Number is shown on product labels.

Table 28: Ordering Information

Part Number	Description	Manufacturer Part Number
PW205010002S	PREMIERWAVE 2050, 802.11ac EMBEDDED WI-FI IOT GATEWAY, LINUX, DUAL U.FL ANT, LGA, 256M FLASH, SINGLE	950-00176
PW205010002B	PREMIERWAVE 2050, 802.11ac EMBEDDED WI-FI IOT GATEWAY, LINUX, DUAL U.FL ANT, LGA, 256M FLASH, TRAY	950-00176
PW205020002S	PREMIERWAVE 2050, 802.11ac EMBEDDED WI-FI IOT GATEWAY, LINUX, U.FL AND CHIP ANT, LGA, 256M FLASH, SINGLE	950-00177
PW205020002S	PREMIERWAVE 2050, 802.11ac EMBEDDED WI-FI IOT GATEWAY, LINUX, U.FL AND CHIP ANT, LGA, 256M FLASH, SINGLE	950-00177
PW205020002B	PREMIERWAVE 2050, 802.11ac EMBEDDED WI-FI IOT GATEWAY, LINUX, U.FL AND CHIP ANT, LGA, 256M FLASH, TRAY	950-00177
PW205030002B	PREMIERWAVE 2050, 802.11ac EMBEDDED WI-FI IOT GATEWAY, LINUX, DUAL U.FL ANT, THROUGH-HOLE PINS, 256M FLASH, TRAY	950-00178
Evaluation and Expansion Boards		
PW205010002K	PREMIERWAVE 2050 EVALUATION KIT, DUAL U.FL ANT, 256M FLASH	950-00206
PW205020002K	PREMIERWAVE 2050 EVALUATION KIT, U.FL AND CHIP ANT, 256M FLASH	950-00207
Accessories		
XPW100A003-01-B	PCB strip antenna bulk pack (50 pieces per box)	

Contact Information

For details contact your local Lantronix representative or Lantronix directly:

- ◆ Asia Pacific Region via e-mail at asiapacific_sales@lantronix.com
- ◆ Europe via e-mail at eu_sales@lantronix.com
- ◆ Japan via e-mail at japan_sales@lantronix.com
- ◆ United States via e-mail at sales@lantronix.com or call OEM sales support at 800-526-8764.

Warranty

The PremierWave 2050 module comes with an industry best 5-year warranty. For more details on the Lantronix warranty replacement policy, please go to our web site at www.lantronix.com/support/warranty.

© 2019 Lantronix, Inc. All rights reserved. No part of the contents of this book may be transmitted or reproduced in any form or by any means without the written permission of Lantronix. *Lantronix* and *PremierWave* are registered trademarks of Lantronix, Inc. in the United States and other countries. Patented: <http://patents.lantronix.com>; additional patents pending.

X-ON Electronics

Largest Supplier of Electrical and Electronic Components

Click to view similar products for [Gateways category](#):

Click to view products by [Lantronix manufacturer](#):

Other Similar products are found below :

[BB-SG30000324-51](#) [MTCDT-LEU1-247A-915-EU-GB-AU](#) [MTCDTIP-LEU1-275L-868](#) [MTCDT-LEU1-246A-868-EU-GB](#) [WOP-2000G-N2AE](#) [ESRP-PCS-ECU1251](#) [BB-SG30300525-42](#) [BB-SG30500520-42](#) [1120730001](#) [SGX5150202US](#) [SGX5150102US](#) [XPC250300S-02](#) [UPS-EDGE-X70864-U01](#) [UPS-EDIOT-X70864-UW01](#) [ADAM-4572-CE](#) [ADAM-6717-A](#) [ECU-1152-R11ABE](#) [EKI-1224-CE](#) [EKI-1224CI-CE](#) [ESRP-PCS-WISE710](#) [ICR-3201](#) [ICR-3201-W](#) [UNO-220-P4N1AE](#) [UNO-2271G-W1032GE](#) [WISE-3310-D100L1E](#) [WISE-3610ILS-51A1N](#) [WISE-6610-E100-A](#) [WISE-6610-N100-A](#) [AKX00016](#) [MESR901](#) [MESR902T](#) [X2-Z11-EM-W](#) [X2-HMU-EM-B](#) [X4-Z1U-B101-A](#) [AGS102-I50-6COM](#) [SGX5150020US](#) [SGX5150225US](#) [SGX51501M2ES](#) [SGX51502N5ES](#) [XPC240200B-02](#) [XPC240400B-02](#) [XPC240100S-02](#) [XPC240200S-02](#) [XPC240300S-02](#) [XPC240400S-02](#) [XPE200100S](#) [WSDA-2000](#) [WSDA-200-USB](#) [1120780001](#)
[1120780002](#)