

## ADL-78051TL

### AIGaAs Infrared Laser Diode

★780nm 5mW 60 °C Reliable Operation!

#### • Features

1. Low operating current
2. High efficiency
3. Better power budget for optical design

#### • Applications

1. Laser printer light source

#### • Absolute maximum ratings

Parameter	Symbol	Condition	Rating	Unit
Light output power	$P_O$	CW	5	mW
Reverse voltage (LD)	$V_{RL}$	-	2	V
Reverse voltage (PD)	$V_{RD}$	-	30	V
Forward current (PD)	$I_{FD}$	-	10	mA
Case temperature	$T_C$	-	-10~+60	°C
Storage temperature	$T_S$	-	-40~+85	°C

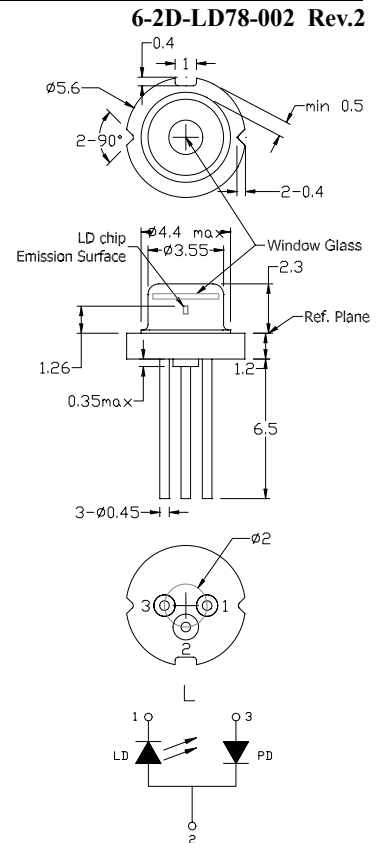

#### • Electrical and optical characteristics ( $T_c=25^\circ\text{C}$ )

Parameter	Symbol	Min.	Typ.	Max.	Unit	Conditions
Peak wavelength	$\lambda$	770	785	795	nm	$P_o=5\text{mW}$
Threshold current	$I_{th}$	10	20	25	mA	
Operating current	$I_{op}$	-	28	40	mA	$P_o=5\text{mW}$
High temperature operating current	$I_{op,H}$	-	-	60	mA	$P_o=5\text{mW}$ , Case=60°C
Operating voltage	$V_{op}$	-	1.8	2.2	V	$P_o=5\text{mW}$
Differential efficiency	$\eta$	0.4	0.5	0.7	mW/mA	$P_o=3\text{--}5\text{mW}$
Monitor current	$I_m$	0.1	0.35	1.0	mA	$P_o=5\text{mW}$ , $V_{RD}=5\text{V}$
Parallel divergence angle	$\theta_{  }$	8	10	12	deg	
Perpendicular divergence angle	$\theta_{\perp}$	25	29	32	deg	
Parallel FFP deviation angle	$\Delta\theta_{  }$	-2	-	+2	deg	
Perpendicular FFP deviation angle	$\Delta\theta_{\perp}$	-2	-	+3	deg	$P_o=5\text{mW}$
Emission point accuracy	$\Delta x \Delta y \Delta z$	-80	-	+80	$\mu\text{m}$	
Astigmatism	As	-	5	10	$\mu\text{m}$	
Droop	$\Delta^P$	-	5	10	%	

#### • Precautions

- \* Do not operate the device above maximum ratings. Doing so may cause unexpected and permanent damage to the device.
- \* Take precautions to avoid electrostatic discharge and/or momentary power spikes. A change in the characteristics of the laser or premature failure may result.
- \* Proper heat sinking of the device assures stability and lifetime. Always ensure that maximum operating temperatures are not exceeded.
- \* Observing visible or invisible laser beams with the human eye directly, or indirectly, can cause permanent damage. Use a camera to observe the laser.
- \* No laser device should be used in any application or situation where life or property is at risk in event of device failure.
- \* Specifications are subject to change without notice. Ensure that you have the latest specification by contacting us prior to purchase or use of the product.

*For reference only. Contents above are subject to change without notice.*

# AlGaAs Infrared Laser Diode

## ADL-78051TL

6-2D-LD78-002 Rev.2

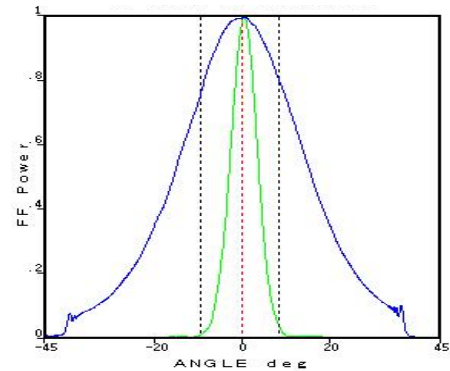
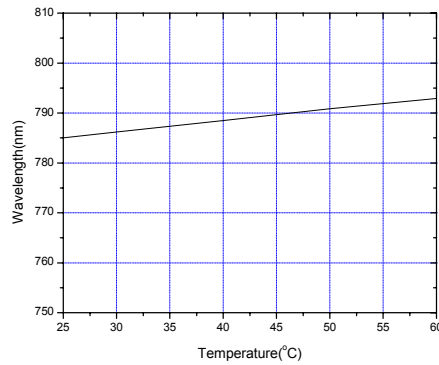
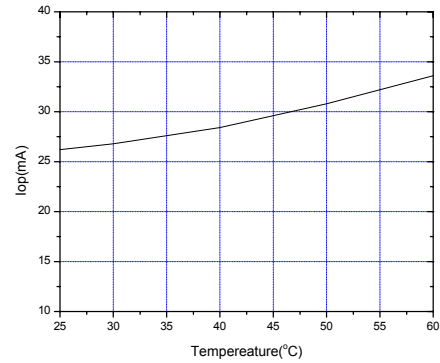
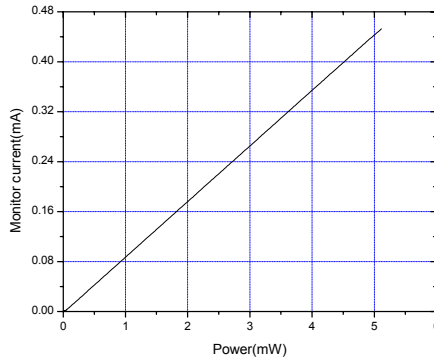
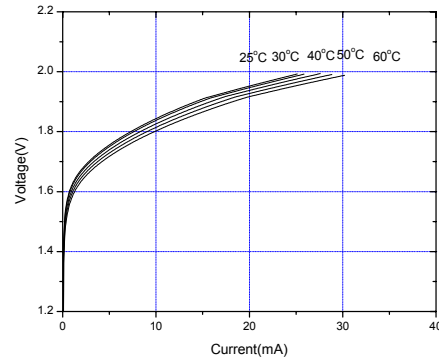
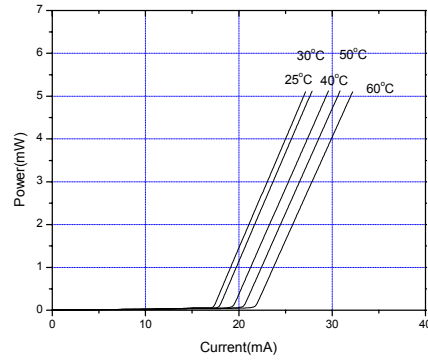

*For reference only. Contents above are subject to change without notice.*

## X-ON Electronics

Largest Supplier of Electrical and Electronic Components

*Click to view similar products for [Laser Diodes](#) category:*

*Click to view products by [Laser Components](#) manufacturer:*

Other Similar products are found below :

[LCU80E052AP](#) [LCU83E061AP](#) [LCU85E061AP](#) [ADL-80Q11TZ](#) [LCU85E061A](#) [JNJ-V-3030CW-850100-S-Q2](#) [JNJ-V-3030CW-850100-S-D1](#) [JNJ-V-8080CW120-850500-SL-D1](#) [JNJ-V-8080CW120-940W001-SL-D1](#) [JNJ-E-TO56F1G-450080-2P3L6.5-J1](#) [JNJ-V-3030EW-665007Z3-S-D1](#) [JNJ-V-3838NJ-808W002-G-D1](#) [HFE4081-321](#) [ADL-63054TL](#) [ADL-63102TL-3](#) [ADL-63153TL](#) [ADL-65103TL](#) [ADL-66201TL](#) [LCU66A051A](#) [ADL-65075TL](#) [905D1S03UA](#) [905D1S09UA](#) [905D1S3JT09UA](#) [ADL-63301TL](#) [ADL-63T01NY](#) [ADL-63V0ANP](#) [ADL-65074TA4](#) [ADL-65074TL-1](#) [ADL-65075SL](#) [ADL-65075SR](#) [ADL-65075TA4](#) [ADL-65075TU-1](#) [ADL-65104TA4](#) [ADL-66201TA4](#) [ADL-66801TL](#) [ADL-78051TL](#) [ADL-83Z51TL](#) [ADL-85051TL](#) [ADL-65055TL](#) [ADL-78101TL](#) [ADL-85301TL](#) [ADL-85501TL](#) [LCU80B051A](#) [LCU632051A](#) [LCU653056AP](#) [LCU66A051AP](#) [LCU670561A](#) [LCU80E053A](#) [LCU831061AP](#) [LCU835060AP](#)