

LCU83E061Ap

LCU83xx SERIES LASER DIODE

■ Features

1. Peak wavelength at 25°C : 830 nm (typical)
2. Standard light output : 500mW (CW)
3. TO-18 (ϕ 5.6mm) Packaged, cap window with flat Pb-free lens, monitor PD inside.
4. Small perpendicular divergence angle

■ Applications

1. Motion sensor
2. 3D depth sensor
3. Illumination
4. Industry
5. Medical application

■ External dimensions(Unit : mm)

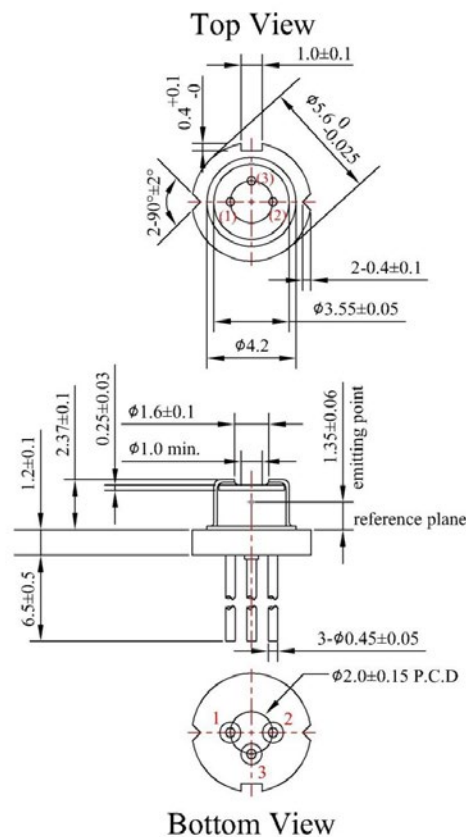
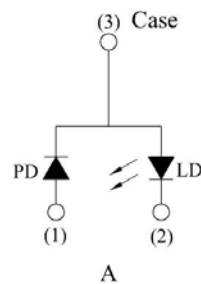

Ver.A

LCU83E061Ap

LCU83xx SERIES LASER DIODE

Absolute Maximum Ratings(Tc=25°C)

Parameter	Symbol	Rating	Unit
Optical Output	Po	500	mW
Reverse Voltage	Vr	2	V
Operating Temperature (Case)	Top	-10~+60	°C
Storage Temperature	Tstg	-40~+85	°C

Electrical and Optical Characteristics(Tc=25°C)

Parameter	Symbol	Condition	Min.	Typ.	Max.	Unit	
Threshold Current	Ith	Po=500mW	-	170	190	mA	
Operating Current	Iop	Po=500mW	-	660	720	mA	
Operating Voltage	Vop	Po=500mW	-	1.95	2.2	V	
Slope Efficiency	η	Po=125-375mW	-	1.0	-	mW/mA	
Monitor Current	Im	Po=500mW	0.1	0.85	2.0	mA	
Beam Divergence (FWHM)	Parallel	θ_{\parallel}	Po=500mW	-	8	13	deg.
	Perpendicular	θ_{\perp}	Po=500mW	-	17	22	deg.
Lasing Wavelength	λ	Po=500mW	820	830	840	nm	

© θ_{\parallel} and θ_{\perp} are defined as the angle within which the intensity is 50% of the peak value.

Quality Notice

This device is still under product development.

Typical characteristic curves

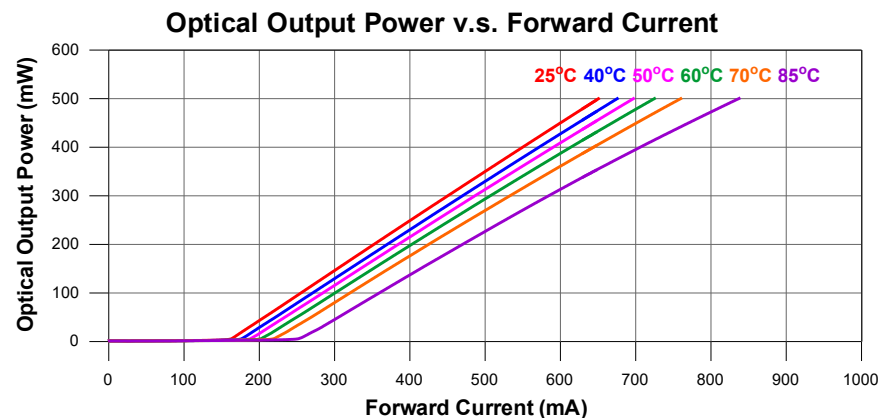

Ver.A

LCU83E061Ap

LCU83xx SERIES LASER DIODE

Forward Voltage v.s. Forward Current

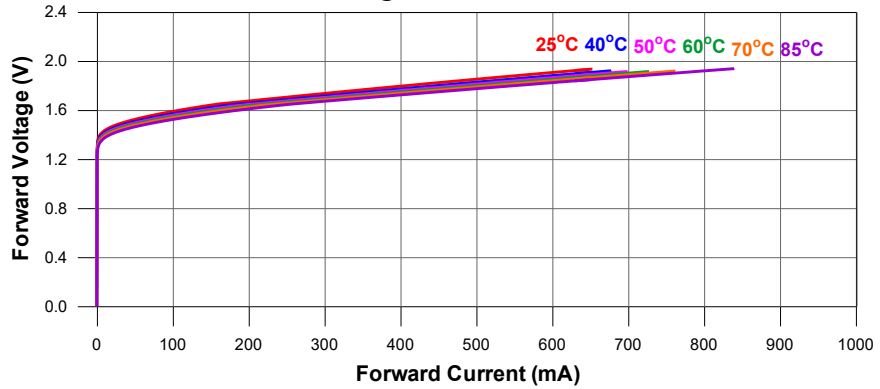

Peak Wavelength v.s. Case Temperature

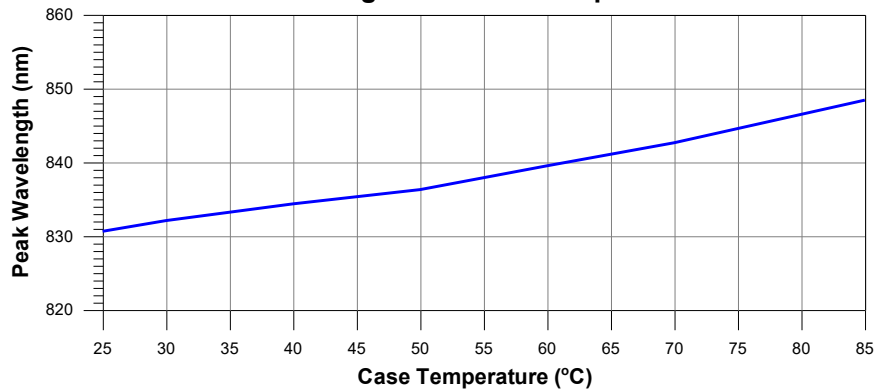

Far-Field Pattern

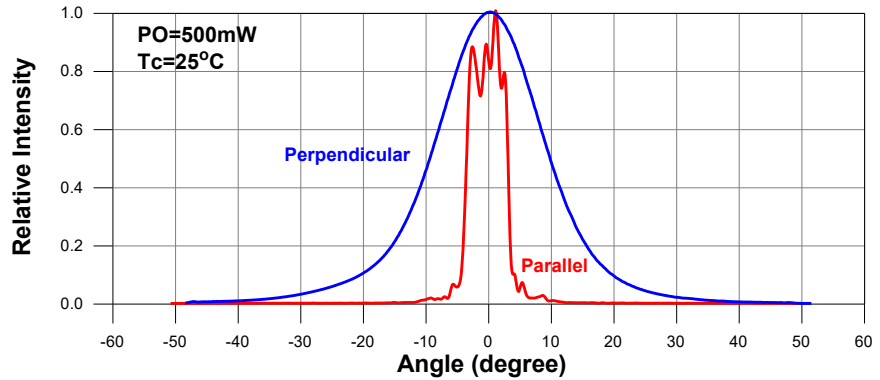

Ver.A

LCU83E061Ap

LCU83xx SERIES LASER DIODE

Monitor Current v.s. Optical Output Power

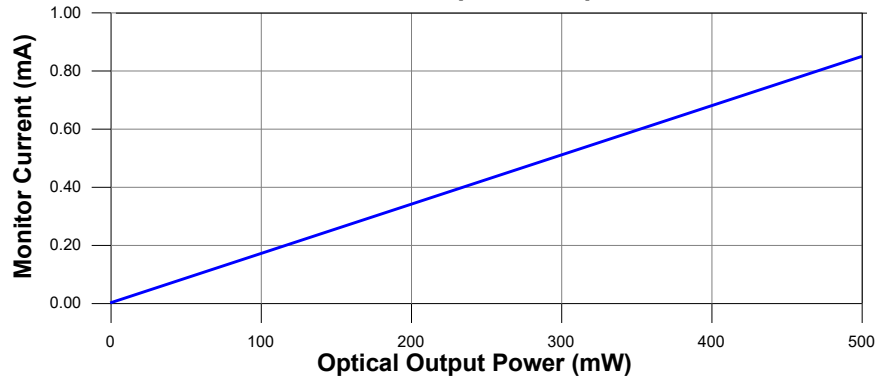

Slope Efficiency v.s. Case Temperature

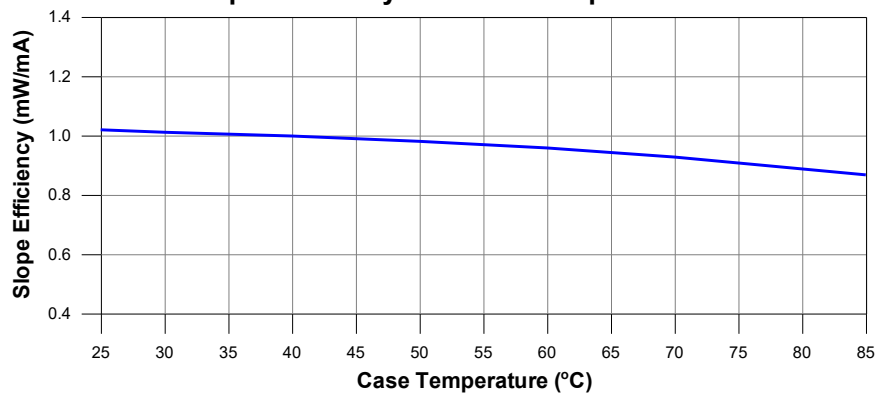

Threshold Current v.s. Case Temperature

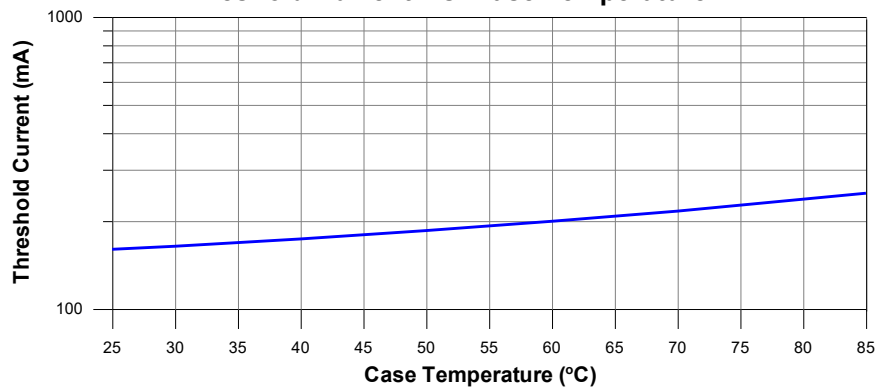

Ver.A

SPECIFICATIONS ARE SUBJECT TO CHANGE WITHOUT NOTICE.

X-ON Electronics

Largest Supplier of Electrical and Electronic Components

Click to view similar products for [Laser Diodes](#) category:

Click to view products by [Laser Components](#) manufacturer:

Other Similar products are found below :

[PLT5 520EA P](#) [PLT3 520D](#) [ADL-65055TL](#) [ADL-66801TL](#) [ADL-83Z01TL](#) [ADL-85301TL](#) [ADL-85501TL](#) [LCU80B051A](#) [RLD78NZM5-00A](#) [ADL-65075SR](#) [ADL-65075TU-1](#) [905D1S3JT09UA](#) [LCU653056AP](#) [LCU66A051AP](#) [LCU80E052AP](#) [LCU80E053A](#) [LCU831061AP](#) [LCU85C061AP](#) [LCU881061AP](#) [LCU98B043AP](#) [LCU98C041AP](#) [PLT5 450B](#) [ADL-63054TL](#) [ADL-63102TL-3](#) [ADL-63153TL](#) [ADL-65103TL](#) [ADL-66201TL](#) [PLT5 510](#) [LCU66A051A](#) [SPL LL90_3](#) [ADL-65075TL](#) [905D1S09UA](#) [905D1S3JT03UA](#) [ADL-63054SL](#) [ADL-63301TL](#) [ADL-63T01NY](#) [ADL-63V0ANP](#) [ADL-65074TA4](#) [ADL-65074TL-1](#) [ADL-65075SL](#) [ADL-65075TA4](#) [ADL-65104TA4](#) [ADL-65104TL](#) [ADL-66201TA4](#) [ADL-66505TL](#) [ADL-78051TL](#) [ADL-83Z51TL](#) [ADL-85051TL](#) [LCU632051A](#) [LCU670561A](#)