

LCU85E061A

LCU850 SERIES LASER DIODE

■ Features

1. Small perpendicular divergence angle
2. Standard optical power output : 500mW (CW)
3. TO-56 (ϕ 5.6mm) package, with Pb-free window cap.
4. Built-in Photo Diode for monitoring laser diode.

■ Applications

1. Motion sensor
2. 3D depth sensor
3. Illumination
4. Industry
5. Medical application

■ External dimensions(Unit : mm)

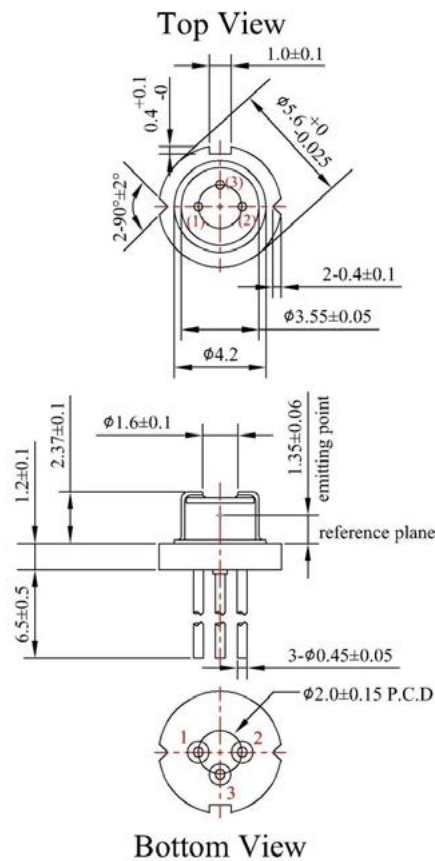
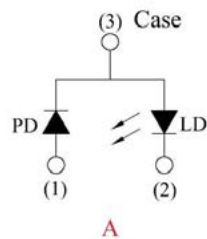

Ver.01

LCU85E061A

LCU850 SERIES LASER DIODE

■ Absolute Maximum Ratings

Parameter	Symbol	Rating	Unit
Optical Output (Tc=25°C)	Po	500	mW
LD Reverse Voltage (Tc=25°C)	Vr_LD	2	V
PD Reverse Voltage (Tc=25°C)	Vr_PD	30	V
Operating Temperature (Case)	Top	-10~+60	°C
Storage Temperature	Tstg	-40~+85	°C

■ Electrical and Optical Characteristics(Tc=25°C)

Parameter	Symbol	Condition	Min.	Typ.	Max.	Unit	
Threshold Current	Ith	-	-	160	180	mA	
Operating Current	Iop	Po=500mW	-	680	720	mA	
Operating Voltage	Vop	Po=500mW	-	1.9	2.2	V	
Slope Efficiency	η	Po=125-375mW	-	0.95	-	mW/mA	
Monitor Current	Im	Po=500mW	0.1	0.9	1.5	mA	
Beam Divergence (FWHM)	Parallel	$\theta_{//}$	Po=500mW	-	8	13	deg.
	Perpendicular	θ_{\perp}	Po=500mW	-	18	23	deg.
Lasing Wavelength	λ	Po=500mW	840	850	860	nm	

© $\theta_{//}$ and θ_{\perp} are defined as the angle within which the intensity is 50% of the peak value.

Ver.01

LCU85E061A

LCU850 SERIES LASER DIODE

■ Typical characteristic curves

Optical Output Power v.s. Forward Current

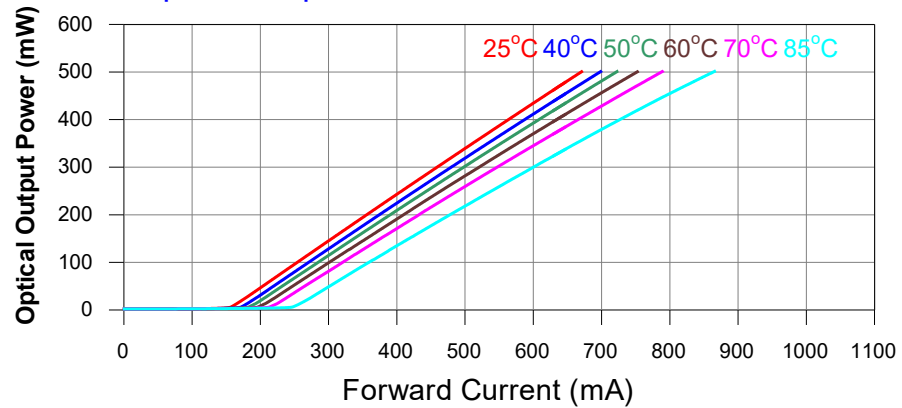

Forward Voltage v.s. Forward Current

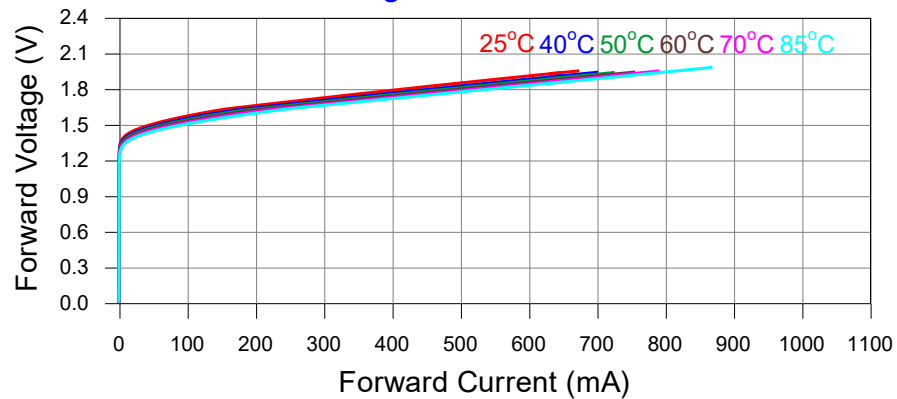

Peak Wavelength v.s. Case Temperature

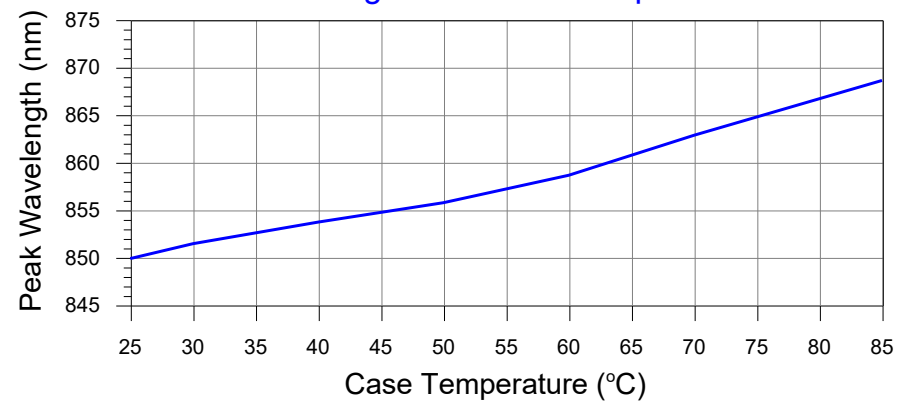

Ver.01

LCU85E061A

LCU850 SERIES LASER DIODE

Far-Field Pattern

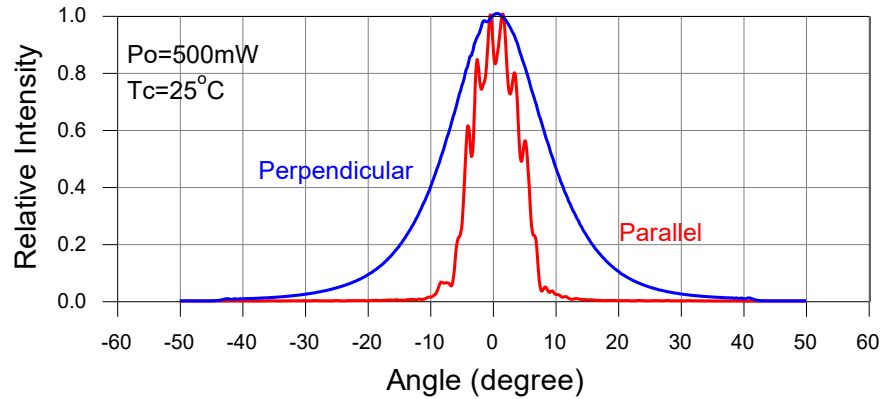

Monitor Current v.s. Optical Output Power

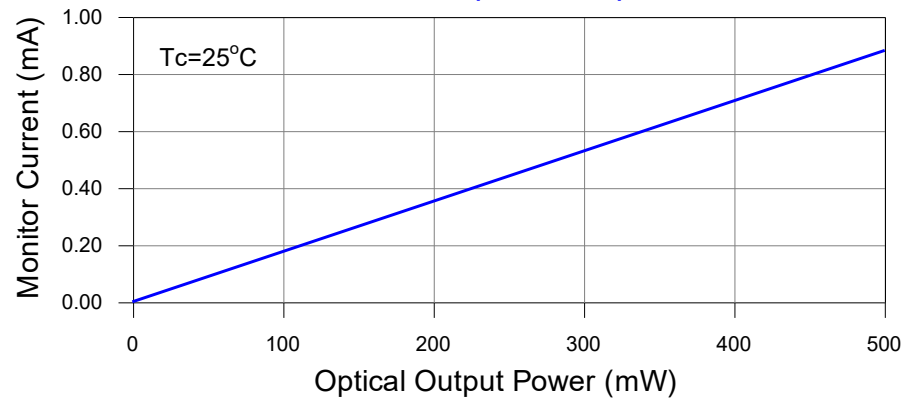

Slope Efficiency v.s. Case Temperature

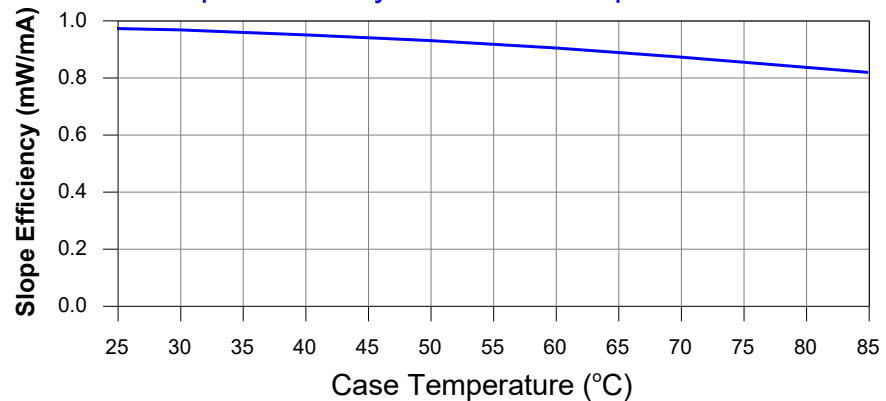

Ver.01

LCU85E061A

LCU850 SERIES LASER DIODE

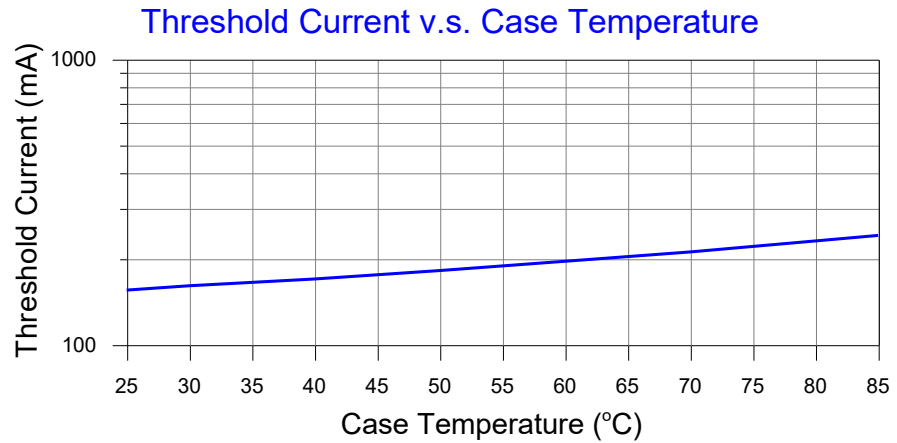

SPECIFICATIONS ARE SUBJECT TO CHANGE WITHOUT NOTICE.

Ver.01

X-ON Electronics

Largest Supplier of Electrical and Electronic Components

Click to view similar products for [Laser Diodes](#) category:

Click to view products by [Laser Components](#) manufacturer:

Other Similar products are found below :

[LCU80E052AP](#) [LCU83E061AP](#) [LCU85E061AP](#) [ADL-80Q11TZ](#) [LCU85E061A](#) [HFE4081-321](#) [ADL-63054TL](#) [ADL-63102TL-3](#) [ADL-63153TL](#) [ADL-65103TL](#) [ADL-66201TL](#) [LCU66A051A](#) [ADL-65075TL](#) [905D1S03UA](#) [905D1S3JT03UA](#) [905D1S3JT09UA](#) [ADL-63301TL](#) [ADL-63T01NY](#) [ADL-63V0ANP](#) [ADL-65074TA4](#) [ADL-65074TL-1](#) [ADL-65075SL](#) [ADL-65075SR](#) [ADL-65075TA4](#) [ADL-65075TU-1](#) [ADL-65104TA4](#) [ADL-66201TA4](#) [ADL-66505TL](#) [ADL-66801TL](#) [ADL-78051TL](#) [ADL-83Z51TL](#) [ADL-85051TL](#) [ADL-65055TL](#) [ADL-78101TL](#) [ADL-85301TL](#) [ADL-85501TL](#) [LCU80B051A](#) [LCU632051A](#) [LCU653056AP](#) [LCU66A051AP](#) [LCU670561A](#) [LCU80E053A](#) [LCU831061AP](#) [LCU835060AP](#) [LCU85C061AP](#) [LCU881061AP](#) [LCU982562A](#) [LCU98B043AP](#) [LCU98C041AP](#) [LCU98E042AP](#)