

LCU98B043Ap

LCU98xx SERIES LASER DIODE

■ Features

1. Peak wavelength at 25°C : 980 nm (typical)
2. Standard light output : 200mW (CW)
3. TO-18 (ϕ 5.6mm) Packaged, cap window with flat Pb-free lens, monitor PD inside.

■ Applications

1. Laser indicator
2. Laser detector
3. Night vision

■ External dimensions(Unit : mm)

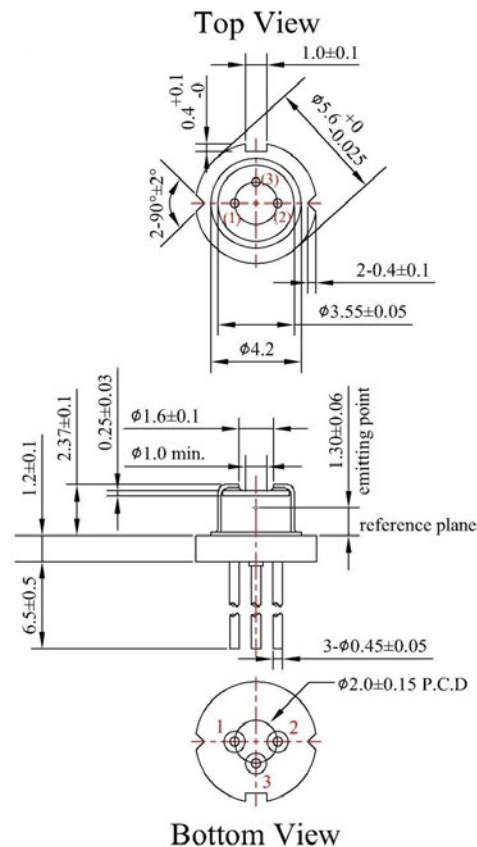
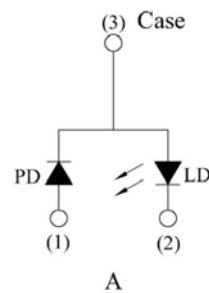

Ver.A

LCU98B043Ap

LCU98xx SERIES LASER DIODE

■ Absolute Maximum Ratings(Tc=25°C)

Parameter	Symbol	Rating	Unit
Optical Output	Po	200	mW
Reverse Voltage	Vr	2	V
Operating Temperature (Case)	Top	-10~+40	°C
Storage Temperature	Tstg	-40~+85	°C

■ Electrical and Optical Characteristics(Tc=25°C)

Parameter	Symbol	Condition	Min.	Typ.	Max.	Unit
Threshold Current	Ith	Po=200mW	-	60	80	mA
Operating Current	Iop	Po=200mW	-	280	365	mA
Operating Voltage	Vop	Po=200mW	1.0	1.48	2.0	Volts
Slope Efficiency	η	Po=50-150mW	0.7	0.9	-	mW/mA
Monitor current	Im	Po=200mW	-	0.4	1.0	mA
Beam Divergence (FWHM)	Parallel	$\theta_{//}$	-	10	-	deg.
	Perpendicular	θ_{\perp}	-	36	-	deg.
Lasing Wavelength	λ	Po=200mW	970	980	990	nm

© $\theta_{//}$ and θ_{\perp} are defined as the angle within which the intensity is 50% of the peak value.

■ Quality Notice

This device is still under product development, the long-term lifetime test has not been qualified yet.

■ Typical characteristic curves

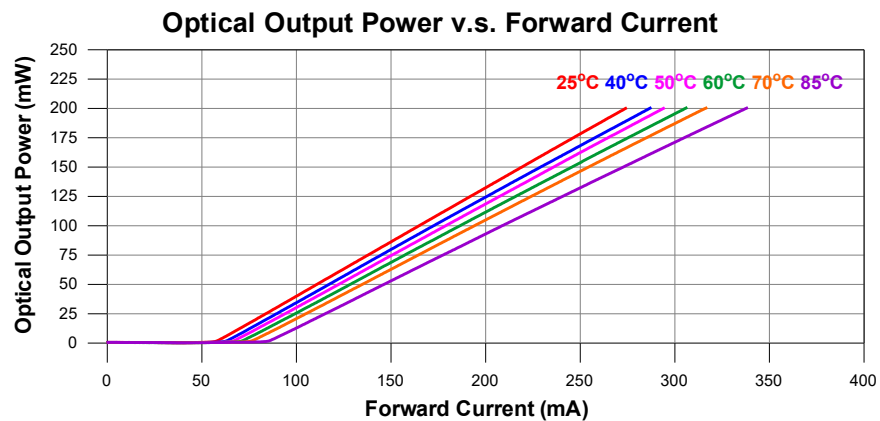

Ver.A

LCU98B043Ap

LCU98xx SERIES LASER DIODE

Forward Voltage v.s. Forward Current

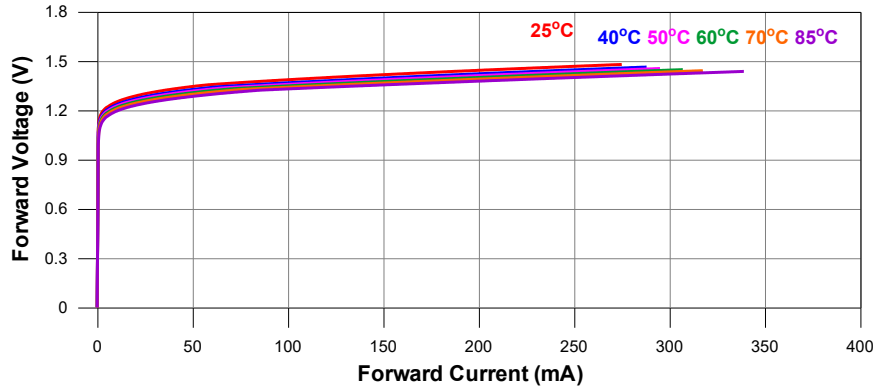

Peak Wavelength v.s. Case Temperature

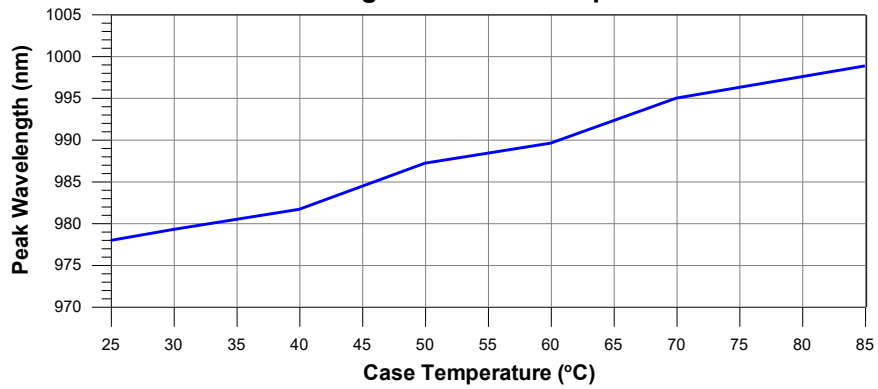

Far-Field Pattern

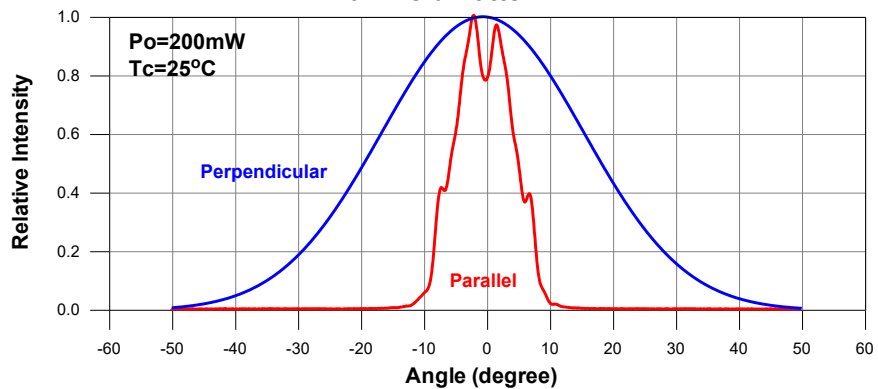

Ver.A

LCU98B043Ap

LCU98xx SERIES LASER DIODE

Monitor Current v.s. Optical Output Power

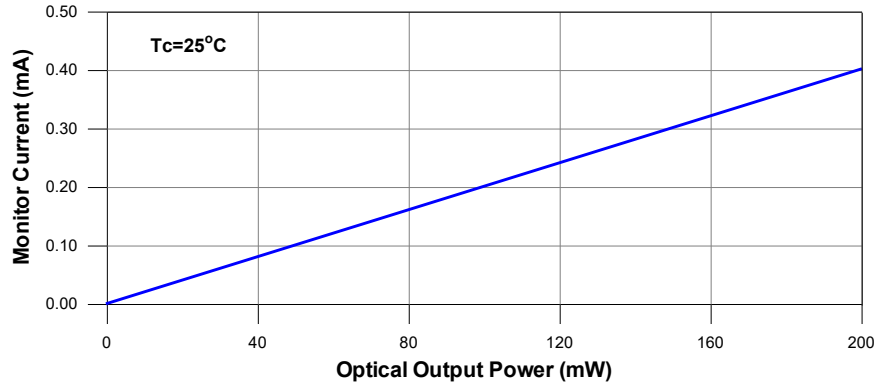

Slope Efficiency v.s. Case Temperature

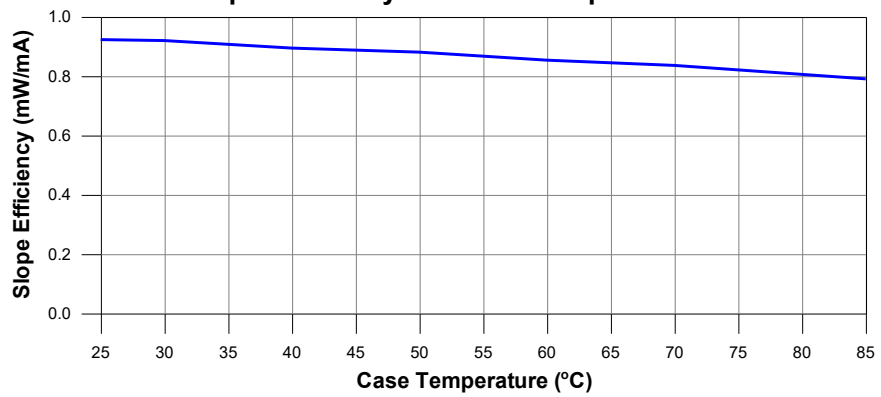

Threshold Current v.s. Case Temperature

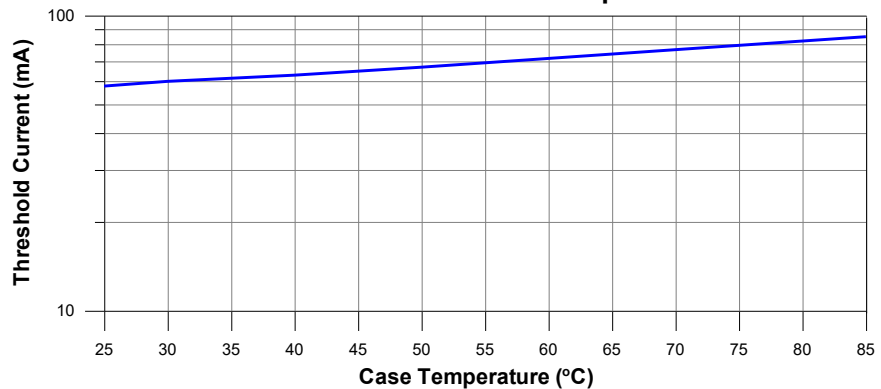

Ver.A

SPECIFICATIONS ARE SUBJECT TO CHANGE WITHOUT NOTICE.

X-ON Electronics

Largest Supplier of Electrical and Electronic Components

Click to view similar products for [Laser Diodes](#) category:

Click to view products by [Laser Components](#) manufacturer:

Other Similar products are found below :

[PLT5 520EA P](#) [PLT3 520D](#) [ADL-65055TL](#) [ADL-66801TL](#) [ADL-83Z01TL](#) [ADL-85301TL](#) [ADL-85501TL](#) [LCU80B051A](#) [RLD78NZM5-00A](#) [ADL-65075SR](#) [ADL-65075TU-1](#) [905D1S3JT09UA](#) [LCU653056AP](#) [LCU66A051AP](#) [LCU80E052AP](#) [LCU80E053A](#) [LCU831061AP](#) [LCU85C061AP](#) [LCU881061AP](#) [LCU98B043AP](#) [LCU98C041AP](#) [PLT5 450B](#) [ADL-63054TL](#) [ADL-63102TL-3](#) [ADL-63153TL](#) [ADL-65103TL](#) [ADL-66201TL](#) [PLT5 510](#) [LCU66A051A](#) [SPL LL90_3](#) [ADL-65075TL](#) [905D1S09UA](#) [905D1S3JT03UA](#) [ADL-63054SL](#) [ADL-63301TL](#) [ADL-63T01NY](#) [ADL-63V0ANP](#) [ADL-65074TA4](#) [ADL-65074TL-1](#) [ADL-65075SL](#) [ADL-65075TA4](#) [ADL-65104TA4](#) [ADL-65104TL](#) [ADL-66201TA4](#) [ADL-66505TL](#) [ADL-78051TL](#) [ADL-83Z51TL](#) [ADL-85051TL](#) [LCU632051A](#) [LCU670561A](#)