

Features

- **HIGH DENSITY PROGRAMMABLE LOGIC**
 - 8,000 PLD Gates
 - 96 I/O Pins, Twelve Dedicated Inputs
 - 288 Registers
 - High-Speed Global Interconnects
 - Wide Input Gating for Fast Counters, State Machines, Address Decoders, etc.
 - Small Logic Block Size for Random Logic
 - Functionally and Pin-out Compatible to ispLSI 1048C
- **HIGH PERFORMANCE E²CMOS[®] TECHNOLOGY**
 - $f_{max} = 125$ MHz Maximum Operating Frequency
 - $t_{pd} = 7.5$ ns Propagation Delay
 - TTL Compatible Inputs and Outputs
 - Electrically Eraseable and Reprogrammable
 - Non-Volatile
 - 100% Tested at Time of Manufacture
- **IN-SYSTEM PROGRAMMABLE**
 - In-System Programmable (ISP[™]) 5V Only
 - Increased Manufacturing Yields, Reduced Time-to-Market and Improved Product Quality
 - Reprogram Soldered Devices for Faster Prototyping
- **OFFERS THE EASE OF USE AND FAST SYSTEM SPEED OF PLDs WITH THE DENSITY AND FLEXIBILITY OF FIELD PROGRAMMABLE GATE ARRAYS**
 - Complete Programmable Device Can Combine Glue Logic and Structured Designs
 - Enhanced Pin Locking Capability
 - Four Dedicated Clock Input Pins
 - Synchronous and Asynchronous Clocks
 - Programmable Output Slew Rate Control to Minimize Switching Noise
 - Flexible Pin Placement
 - Optimized Global Routing Pool Provides Global Interconnectivity
 - Lead-Free Package Options

Functional Block Diagram

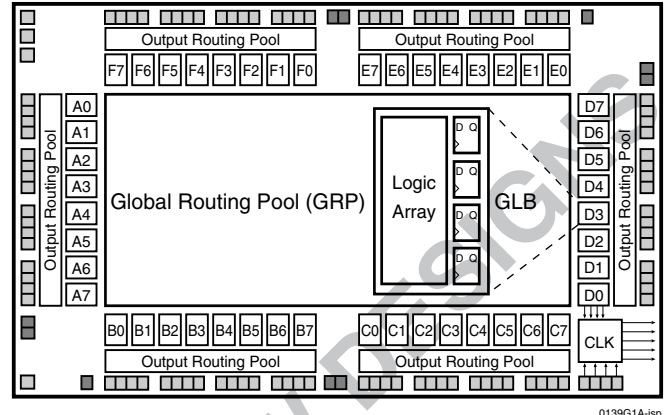

Description

The ispLSI 1048E is a High Density Programmable Logic Device containing 288 Registers, 96 Universal I/O pins, 12 Dedicated Input pins, 4 Dedicated Clock Input pins, two dedicated Global OE input pins, and a Global Routing Pool (GRP). The GRP provides complete interconnectivity between all of these elements. The ispLSI 1048E offers 5V non-volatile in-system programmability of the logic, as well as the interconnect to provide truly reconfigurable systems. A functional superset of the ispLSI 1048 architecture, the ispLSI 1048E device adds two new global output enable pins and two additional dedicated inputs.

The basic unit of logic on the ispLSI 1048E device is the Generic Logic Block (GLB). The GLBs are labeled A0, A1...F7 (see Figure 1). There are a total of 48 GLBs in the ispLSI 1048E device. Each GLB has 18 inputs, a programmable AND/OR/Exclusive OR array, and four outputs which can be configured to be either combinatorial or registered. Inputs to the GLB come from the GRP and dedicated inputs. All of the GLB outputs are brought back into the GRP so that they can be connected to the inputs of any other GLB on the device.

Functional Block Diagram

Figure 1. ispLSI 1048E Functional Block Diagram

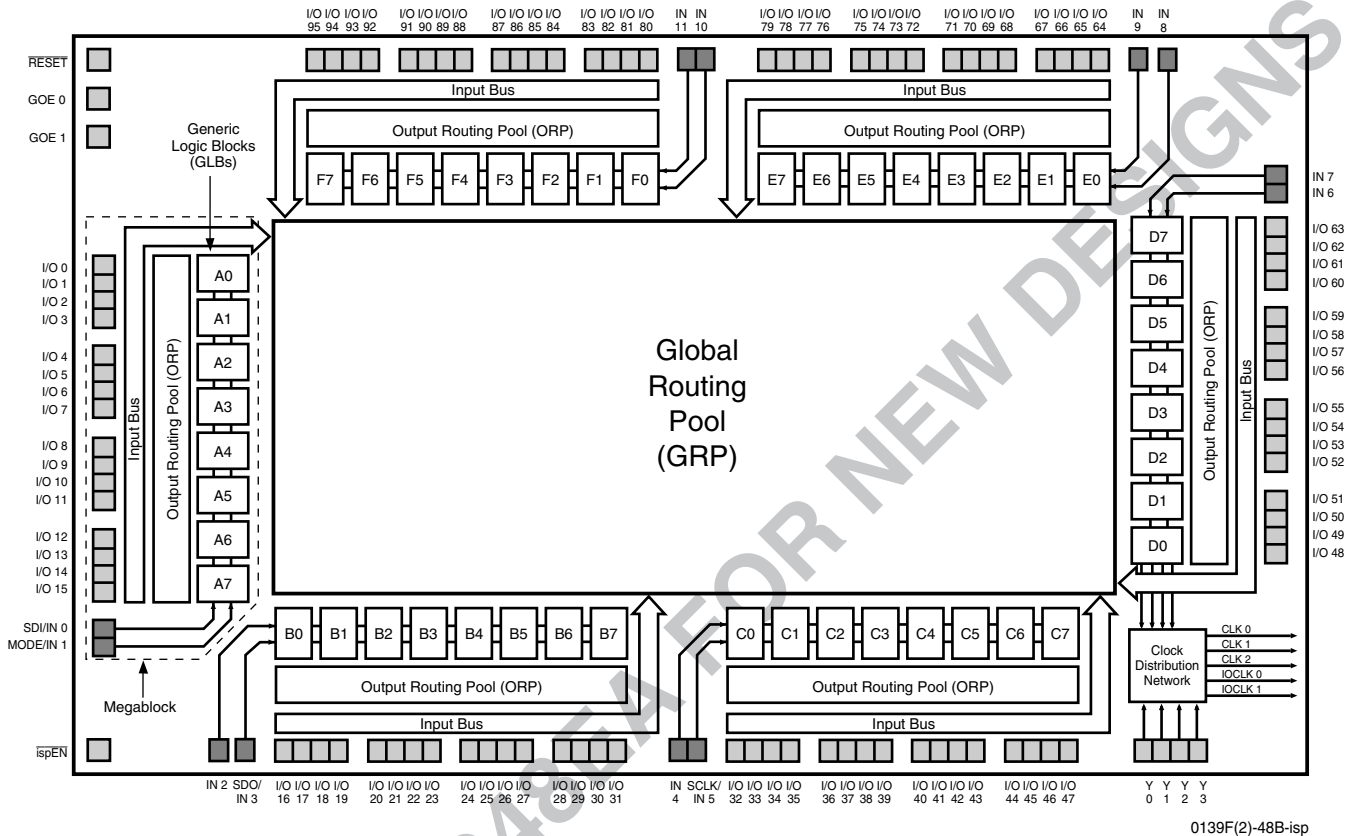

The device also has 96 I/O cells, each of which is directly connected to an I/O pin. Each I/O cell can be individually programmed to be a combinatorial input, registered input, latched input, output or bi-directional I/O pin with 3-state control. The signal levels are TTL compatible voltages and the output drivers can source 4 mA or sink 8 mA. Each output can be programmed independently for fast or slow output slew rate to minimize overall output switching noise.

Eight GLBs, 16 I/O cells, two dedicated inputs and one ORP are connected together to make a Megablock (see figure 1). The outputs of the eight GLBs are connected to a set of 16 universal I/O cells by the ORP. Each ispLSI 1048E device contains six Megablocks.

The GRP has, as its inputs, the outputs from all of the GLBs and all of the inputs from the bi-directional I/O cells. All of these signals are made available to the inputs of the GLBs. Delays through the GRP have been equalized to minimize timing skew.

Clocks in the ispLSI 1048E device are selected using the Clock Distribution Network. Four dedicated clock pins (Y0, Y1, Y2 and Y3) are brought into the distribution network, and five clock outputs (CLK 0, CLK 1, CLK 2, IOCLK 0 and IOCLK 1) are provided to route clocks to the GLBs and I/O cells. The Clock Distribution Network can also be driven from a special clock GLB (D0). The logic of this GLB allows the user to create an internal clock from a combination of internal signals within the device.

Absolute Maximum Ratings ¹

- Supply Voltage V_{CC} -0.5 to +7.0V
- Input Voltage Applied -2.5 to $V_{CC} + 1.0V$
- Off-State Output Voltage Applied -2.5 to $V_{CC} + 1.0V$
- Storage Temperature -65 to 150°C
- Case Temp. with Power Applied -55 to 125°C
- Max. Junction Temp. (T_J) with Power Applied ... 150°C

1. Stresses above those listed under the “Absolute Maximum Ratings” may cause permanent damage to the device. Functional operation of the device at these or at any other conditions above those indicated in the operational sections of this specification is not implied (while programming, follow the programming specifications).

DC Recommended Operating Conditions

SYMBOL	PARAMETER		MIN.	MAX.	UNITS
V_{CC}	Supply Voltage	Commercial $T_A = 0^\circ\text{C to } +70^\circ\text{C}$	4.75	5.25	V
		Industrial $T_A = -40^\circ\text{C to } +85^\circ\text{C}$	4.5	5.5	V
V_{IL}	Input Low Voltage		0	0.8	V
V_{IH}	Input High Voltage		2.0	$V_{CC} + 1$	V

Table 2-0005/1048E

Capacitance ($T_A = 25^\circ\text{C}$, $f = 1.0\text{ MHz}$)

SYMBOL	PARAMETER	TYPICAL	UNITS	TEST CONDITIONS
C_1	Dedicated Input, I/O, Y1, Y2, Y3, Clock Capacitance	8	pf	$V_{CC} = 5.0V$, $V_{PIN} = 2.0V$
C_2	Y0 Clock Capacitance	15	pf	$V_{CC} = 5.0V$, $V_{PIN} = 2.0V$

Table 2-0006/1048E

Data Retention Specifications

PARAMETER	MINIMUM	MAXIMUM	UNITS
Data Retention	20	–	Years
Erase/Reprogram Cycles	10000	–	Cycles

Table 2-0008/1048E

Switching Test Conditions

Input Pulse Levels	GND to 3.0V
Input Rise and Fall Time	≤ 3 ns 10% to 90%
Input Timing Reference Levels	1.5V
Output Timing Reference Levels	1.5V
Output Load	See Figure 2

3-state levels are measured 0.5V from steady-state active level.

Table 2-0003/1048E

Figure 2. Test Load

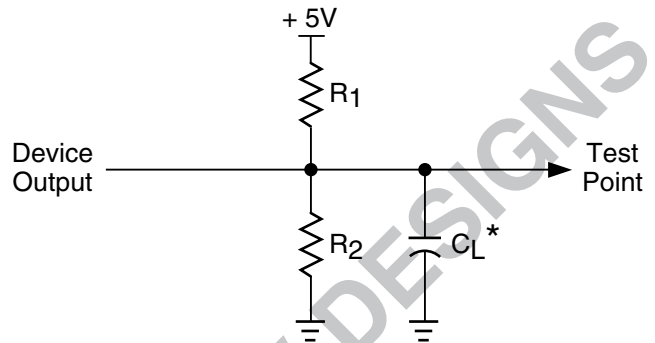

Output Load Conditions (see Figure 2)

TEST CONDITION		R1	R2	CL
A		470Ω	390Ω	35pF
B	Active High	∞	390Ω	35pF
	Active Low	470Ω	390Ω	35pF
C	Active High to Z at $V_{OH}-0.5V$	∞	390Ω	5pF
	Active Low to Z at $V_{OL}+0.5V$	470Ω	390Ω	5pF

Table 2-0004a

*CL includes Test Fixture and Probe Capacitance.

0213a

DC Electrical Characteristics

Over Recommended Operating Conditions

SYMBOL	PARAMETER	CONDITION	MIN.	TYP. ³	MAX.	UNITS
V_{OL}	Output Low Voltage	$I_{OL} = 8 \text{ mA}$	-	-	0.4	V
V_{OH}	Output High Voltage	$I_{OH} = -4 \text{ mA}$	2.4	-	-	V
I_{IL}	Input or I/O Low Leakage Current	$0V \leq V_{IN} \leq V_{IL} (\text{Max.})$	-	-	-10	μA
I_{IH}	Input or I/O High Leakage Current	$3.5V \leq V_{IN} \leq V_{CC}$	-	-	10	μA
I_{IL-isp}	ispEN Input Low Leakage Current	$0V \leq V_{IN} \leq V_{IL}$	-	-	-150	μA
I_{IL-PU}	I/O Active Pull-Up Current	$0V \leq V_{IN} \leq V_{IL}$	-	-	-150	μA
I_{OS}¹	Output Short Circuit Current	$V_{CC} = 5V, V_{OUT} = 0.5V$	-	-	-200	mA
I_{CC}^{2,4}	Operating Power Supply Current	$V_{IL} = 0.0V, V_{IH} = 3.0V$	-	175	-	mA
		$f_{CLOCK} = 1 \text{ MHz}$	-	175	-	mA

1. One output at a time for a maximum duration of one second. $V_{OUT} = 0.5V$ was selected to avoid test problems by tester ground degradation. Characterized but not 100% tested. Table 2-0007/1048E

2. Measured using twelve 16-bit counters.

3. Typical values are at $V_{CC} = 5V$ and $T_A = 25^\circ C$.

4. Maximum I_{CC} varies widely with specific device configuration and operating frequency. Refer to the Power Consumption section of this data sheet and Thermal Management section of the Lattice Semiconductor Data Book or CD-ROM to estimate maximum I_{CC} .

External Timing Parameters

Over Recommended Operating Conditions

PARAMETER	TEST COND. ⁴	# ²	DESCRIPTION ¹	-125		-100		-90		UNITS
				MIN.	MAX.	MIN.	MAX.	MIN.	MAX.	
t _{pd1}	A	1	Data Propagation Delay, 4PT Bypass, ORP Bypass	–	7.5	–	10.0	–	10.0	ns
t _{pd2}	A	2	Data Propagation Delay, Worst Case Path	–	10.0	–	12.5	–	12.5	ns
f _{max} (Int.)	A	3	Clock Frequency with Internal Feedback ³	125.0	–	100.0	–	90.9	–	MHz
f _{max} (Ext.)	–	4	Clock Frequency with External Feedback ($\frac{1}{t_{su2} + t_{co1}}$)	91.0	–	71.0	–	71.0	–	MHz
f _{max} (Tog.)	–	5	Clock Frequency, Max. Toggle ($\frac{1}{t_{wh} + t_{wl}}$)	167.0	–	125.0	–	125.0	–	MHz
t _{su1}	–	6	GLB Reg. Setup Time before Clock, 4 PT Bypass	5.5	–	6.5	–	6.5	–	ns
t _{co1}	A	7	GLB Reg. Clock to Output Delay, ORP Bypass	–	4.5	–	6.5	–	6.5	ns
t _{h1}	–	8	GLB Reg. Hold Time after Clock, 4 PT Bypass	0.0	–	0.0	–	0.0	–	ns
t _{su2}	–	9	GLB Reg. Setup Time before Clock	6.5	–	7.5	–	7.5	–	ns
t _{co2}	–	10	GLB Reg. Clock to Output Delay	–	5.5	–	7.5	–	7.5	ns
t _{h2}	–	11	GLB Reg. Hold Time after Clock	0.0	–	0.0	–	0.0	–	ns
t _{r1}	A	12	Ext. Reset Pin to Output Delay	–	10.0	–	13.5	–	13.5	ns
t _{rw1}	–	13	Ext. Reset Pulse Duration	5.0	–	6.5	–	6.5	–	ns
t _{ptoen}	B	14	Input to Output Enable	–	12.0	–	15.0	–	15.0	ns
t _{ptoedis}	C	15	Input to Output Disable	–	12.0	–	15.0	–	15.0	ns
t _{goeen}	B	16	Global OE Output Enable	–	7.0	–	9.0	–	9.0	ns
t _{goedis}	C	17	Global OE Output Disable	–	7.0	–	9.0	–	9.0	ns
t _{wh}	–	18	External Synchronous Clock Pulse Duration, High	3.0	–	4.0	–	4.0	–	ns
t _{wl}	–	19	External Synchronous Clock Pulse Duration, Low	3.0	–	4.0	–	4.0	–	ns
t _{su3}	–	20	I/O Reg. Setup Time before Ext. Sync Clock (Y2, Y3)	3.0	–	3.5	–	4.0	–	ns
t _{h3}	–	21	I/O Reg. Hold Time after Ext. Sync. Clock (Y2, Y3)	0.0	–	0.0	–	0.0	–	ns

Table 2-0030A/1048E

1. Unless noted otherwise, all parameters use a GRP load of 4 GLBs, 20 PTXOR path, ORP and Y0 clock.
2. Refer to Timing Model in this data sheet for further details.
3. Standard 16-bit counter using GRP feedback.
4. Reference Switching Test Conditions section.

External Timing Parameters

Over Recommended Operating Conditions

PARAMETER	TEST COND. ⁴	# ²	DESCRIPTION ¹	-70		-50		UNITS
				MIN.	MAX.	MIN.	MAX.	
t _{pd1}	A	1	Data Propagation Delay, 4PT Bypass, ORP Bypass	–	15.0	–	20.0	ns
t _{pd2}	A	2	Data Propagation Delay, Worst Case Path	–	18.5	–	24.5	ns
f _{max} (Int.)	A	3	Clock Frequency with Internal Feedback ³	70.0	–	50.0	–	MHz
f _{max} (Ext.)	–	4	Clock Frequency with External Feedback ($\frac{1}{t_{su2} + t_{co1}}$)	56.0	–	42.0	–	MHz
f _{max} (Tog.)	–	5	Clock Frequency, Max. Toggle ($\frac{1}{t_{wh} + t_{wl}}$)	100.0	–	77.0	–	MHz
t _{su1}	–	6	GLB Reg. Setup Time before Clock, 4 PT Bypass	9.0	–	12.0	–	ns
t _{co1}	A	7	GLB Reg. Clock to Output Delay, ORP Bypass	–	7.0	–	9.5	ns
t _{h1}	–	8	GLB Reg. Hold Time after Clock, 4 PT Bypass	0.0	–	0.0	–	ns
t _{su2}	–	9	GLB Reg. Setup Time before Clock	11.0	–	14.5	–	ns
t _{co2}	–	10	GLB Reg. Clock to Output Delay	–	9.0	–	12.0	ns
t _{h2}	–	11	GLB Reg. Hold Time after Clock	0.0	–	0.0	–	ns
t _{r1}	A	12	Ext. Reset Pin to Output Delay	–	15.0	–	20.5	ns
t _{rw1}	–	13	Ext. Reset Pulse Duration	10.0	–	13.0	–	ns
t _{ptoen}	B	14	Input to Output Enable	–	18.0	–	24.0	ns
t _{ptoedis}	C	15	Input to Output Disable	–	18.0	–	24.0	ns
t _{goeen}	B	16	Global OE Output Enable	–	12.0	–	16.0	ns
t _{goedis}	C	17	Global OE Output Disable	–	12.0	–	16.0	ns
t _{wh}	–	18	External Synchronous Clock Pulse Duration, High	5.0	–	6.5	–	ns
t _{wl}	–	19	External Synchronous Clock Pulse Duration, Low	5.0	–	6.5	–	ns
t _{su3}	–	20	I/O Reg. Setup Time before Ext. Sync Clock (Y2, Y3)	4.0	–	6.5	–	ns
t _{h3}	–	21	I/O Reg. Hold Time after Ext. Sync. Clock (Y2, Y3)	0.0	–	0.0	–	ns

Table 2-0030B/1048E

1. Unless noted otherwise, all parameters use a GRP load of 4 GLBs, 20 PTXOR path, ORP and Y0 clock.
2. Refer to Timing Model in this data sheet for further details.
3. Standard 16-bit counter using GRP feedback.
4. Reference Switching Test Conditions section.

Internal Timing Parameters¹

PARAMETER	# ²	DESCRIPTION	-125		-100		-90		UNITS
			MIN.	MAX.	MIN.	MAX.	MIN.	MAX.	
Inputs									
t _{iobp}	22	I/O Register Bypass	–	0.3	–	0.3	–	0.5	ns
t _{iolat}	23	I/O Latch Delay	–	1.9	–	2.3	–	2.5	ns
t _{iosu}	24	I/O Register Setup Time before Clock	3.0	–	3.5	–	4.0	–	ns
t _{ioh}	25	I/O Register Hold Time after Clock	0.0	–	0.0	–	-0.5	–	ns
t _{ioco}	26	I/O Register Clock to Out Delay	–	4.6	–	5.0	–	5.0	ns
t _{ior}	27	I/O Register Reset to Out Delay	–	4.6	–	5.0	–	5.0	ns
t _{din}	28	Dedicated Input Delay	–	2.3	–	2.7	–	2.9	ns
GRP									
t _{grp1}	29	GRP Delay, 1 GLB Load	–	1.8	–	1.9	–	2.2	ns
t _{grp4}	30	GRP Delay, 4 GLB Loads	–	2.0	–	2.4	–	2.4	ns
t _{grp8}	31	GRP Delay, 8 GLB Loads	–	2.3	–	2.6	–	2.7	ns
t _{grp16}	32	GRP Delay, 16 GLB Loads	–	2.8	–	3.0	–	3.3	ns
t _{grp48}	33	GRP Delay, 48 GLB Loads	–	4.9	–	5.4	–	5.7	ns
GLB									
t _{4ptbpc}	34	4 Product Term Bypass Path Delay (Combinatorial)	–	3.9	–	5.3	–	5.4	ns
t _{4ptbpr}	35	4 Product Term Bypass Path Delay (Registered)	–	4.0	–	5.3	–	6.3	ns
t _{1ptxor}	36	1 Product Term/XOR Path Delay	–	3.6	–	4.6	–	6.5	ns
t _{20ptxor}	37	20 Product Term/XOR Path Delay	–	5.0	–	5.8	–	6.5	ns
t _{xoradj}	38	XOR Adjacent Path Delay ³	–	5.0	–	6.3	–	7.3	ns
t _{gbp}	39	GLB Register Bypass Delay	–	0.4	–	1.0	–	0.4	ns
t _{gsu}	40	GLB Register Setup Time before Clock	0.1	–	0.5	–	0.1	–	ns
t _{gh}	41	GLB Register Hold Time after Clock	4.5	–	5.3	–	6.4	–	ns
t _{gco}	42	GLB Register Clock to Output Delay	–	2.3	–	2.5	–	2.0	ns
t _{gro}	43	GLB Register Reset to Output Delay	–	4.9	–	6.2	–	6.3	ns
t _{ptre}	44	GLB Product Term Reset to Register Delay	–	3.9	–	4.5	–	5.0	ns
t _{ptoe}	45	GLB Product Term Output Enable to I/O Cell Delay	–	5.4	–	7.2	–	5.7	ns
t _{ptck}	46	GLB Product Term Clock Delay	2.9	4.0	3.5	4.7	4.0	5.2	ns
ORP									
t _{orp}	47	ORP Delay	–	1.0	–	1.0	–	1.0	ns
t _{orpbp}	48	ORP Bypass Delay	–	0.0	–	0.0	–	0.0	ns

1. Internal Timing Parameters are not tested and are for reference only.
2. Refer to Timing Model in this data sheet for further details.
3. The XOR adjacent path can only be used by hard macros.

Table 2-0036A/1048E

Internal Timing Parameters¹

PARAMETER	# ²	DESCRIPTION	-70		-50		UNITS
			MIN.	MAX.	MIN.	MAX.	
Inputs							
t _{iobp}	22	I/O Register Bypass	–	0.6	–	0.7	ns
t _{iolat}	23	I/O Latch Delay	–	3.6	–	4.7	ns
t _{iosu}	24	I/O Register Setup Time before Clock	4.1	–	6.5	–	ns
t _{ioh}	25	I/O Register Hold Time after Clock	-0.6	–	-0.7	–	ns
t _{ioco}	26	I/O Register Clock to Out Delay	–	6.0	–	7.0	ns
t _{ior}	27	I/O Register Reset to Out Delay	–	6.0	–	7.0	ns
t _{din}	28	Dedicated Input Delay	–	4.3	–	6.1	ns
GRP							
t _{grp1}	29	GRP Delay, 1 GLB Load	–	3.5	–	5.1	ns
t _{grp4}	30	GRP Delay, 4 GLB Loads	–	3.7	–	5.4	ns
t _{grp8}	31	GRP Delay, 8 GLB Loads	–	4.1	–	5.8	ns
t _{grp16}	32	GRP Delay, 16 GLB Loads	–	4.8	–	6.6	ns
t _{grp48}	33	GRP Delay, 48 GLB Loads	–	7.5	–	9.8	ns
GLB							
t _{4ptbpc}	34	4 Product Term Bypass Path Delay (Combinatorial)	–	8.5	–	10.7	ns
t _{4ptbpr}	35	4 Product Term Bypass Path Delay (Registered)	–	7.4	–	9.2	ns
t _{1ptxor}	36	1 Product Term/XOR Path Delay	–	8.4	–	10.5	ns
t _{20ptxor}	37	20 Product Term/XOR Path Delay	–	8.4	–	10.5	ns
t _{xoradj}	38	XOR Adjacent Path Delay ³	–	9.4	–	11.7	ns
t _{gbp}	39	GLB Register Bypass Delay	–	1.6	–	2.2	ns
t _{gsu}	40	GLB Register Setup Time before Clock	0.1	–	0.0	–	ns
t _{gh}	41	GLB Register Hold Time after Clock	8.5	–	11.5	–	ns
t _{gco}	42	GLB Register Clock to Output Delay	–	2.0	–	3.0	ns
t _{gro}	43	GLB Register Reset to Output Delay	–	6.3	–	7.3	ns
t _{ptre}	44	GLB Product Term Reset to Register Delay	–	6.1	–	7.9	ns
t _{ptoe}	45	GLB Product Term Output Enable to I/O Cell Delay	–	6.8	–	10.0	ns
t _{ptck}	46	GLB Product Term Clock Delay	5.1	6.4	6.9	8.3	ns
ORP							
t _{orp}	47	ORP Delay	–	2.0	–	2.5	ns
t _{orpbp}	48	ORP Bypass Delay	–	0.0	–	0.0	ns

Table 2-0036B/1048E

1. Internal Timing Parameters are not tested and are for reference only.
2. Refer to Timing Model in this data sheet for further details.
3. The XOR adjacent path can only be used by hard macros.

Internal Timing Parameters¹

PARAMETER	#	DESCRIPTION	-125		-100		-90		UNITS
			MIN.	MAX.	MIN.	MAX.	MIN.	MAX.	
Outputs									
t_{ob}	49	Output Buffer Delay	–	1.3	–	2.0	–	1.7	ns
t_{sl}	50	Output Slew Limited Delay Adder	–	10.0	–	10.0	–	12.0	ns
t_{oen}	51	I/O Cell OE to Output Enabled	–	4.3	–	5.1	–	6.4	ns
t_{odis}	52	I/O Cell OE to Output Disabled	–	4.3	–	5.1	–	6.4	ns
t_{goe}	53	Global OE	–	2.7	–	3.9	–	2.6	ns
Clocks									
t_{gy0}	54	Clock Delay, Y0 to Global GLB Clock Line (Ref. clock)	0.9	0.9	2.0	2.0	2.8	2.8	ns
t_{gy1/2}	55	Clock Delay, Y1 or Y2 to Global GLB Clock Line	0.9	0.9	2.0	2.0	2.8	2.8	ns
t_{gcp}	56	Clock Delay, Clock GLB to Global GLB Clock Line	0.8	1.8	0.8	1.8	0.8	1.8	ns
t_{ioy2/3}	57	Clock Delay, Y2 or Y3 to I/O Cell Global Clock Line	0.0	0.0	0.0	0.0	0.0	0.5	ns
t_{iocp}	58	Clock Delay, Clock GLB to I/O Cell Global Clock Line	0.8	1.8	0.8	1.8	0.8	1.8	ns
Global Reset									
t_{gr}	59	Global Reset to GLB and I/O Registers	–	2.8	–	4.3	–	4.5	ns

Table 2-0037A/1048E

1. Internal timing parameters are not tested and are for reference only.
2. Refer to Timing Model in this data sheet for further details.

USE ispLSI 1048EA FOR NEW DESIGNS

Internal Timing Parameters¹

PARAMETER	#	DESCRIPTION	-70		-50		UNITS
			MIN.	MAX.	MIN.	MAX.	
Outputs							
t_{ob}	49	Output Buffer Delay	–	2.2	–	3.2	ns
t_{sl}	50	Output Slew Limited Delay Adder	–	12.0	–	12.0	ns
t_{oen}	51	I/O Cell OE to Output Enabled	–	6.9	–	7.9	ns
t_{odis}	52	I/O Cell OE to Output Disabled	–	6.9	–	7.9	ns
t_{goe}	53	Global OE	–	5.1	–	8.1	ns
Clocks							
t_{gy0}	54	Clock Delay, Y0 to Global GLB Clock Line (Ref. clock)	2.8	2.8	3.3	3.3	ns
t_{gy1/2}	55	Clock Delay, Y1 or Y2 to Global GLB Clock Line	2.8	2.8	3.3	3.3	ns
t_{gcp}	56	Clock Delay, Clock GLB to Global GLB Clock Line	0.8	1.8	0.8	1.8	ns
t_{ioy2/3}	57	Clock Delay, Y2 or Y3 to I/O Cell Global Clock Line	0.1	0.6	0.0	0.7	ns
t_{iocp}	58	Clock Delay, Clock GLB to I/O Cell Global Clock Line	0.8	1.8	0.8	1.8	ns
Global Reset							
t_{gr}	59	Global Reset to GLB and I/O Registers	–	4.5	–	7.5	ns

1. Internal timing parameters are not tested and are for reference only.
2. Refer to Timing Model in this data sheet for further details.

Table 2-0037B/1048E

ispLSI 1048E Timing Model

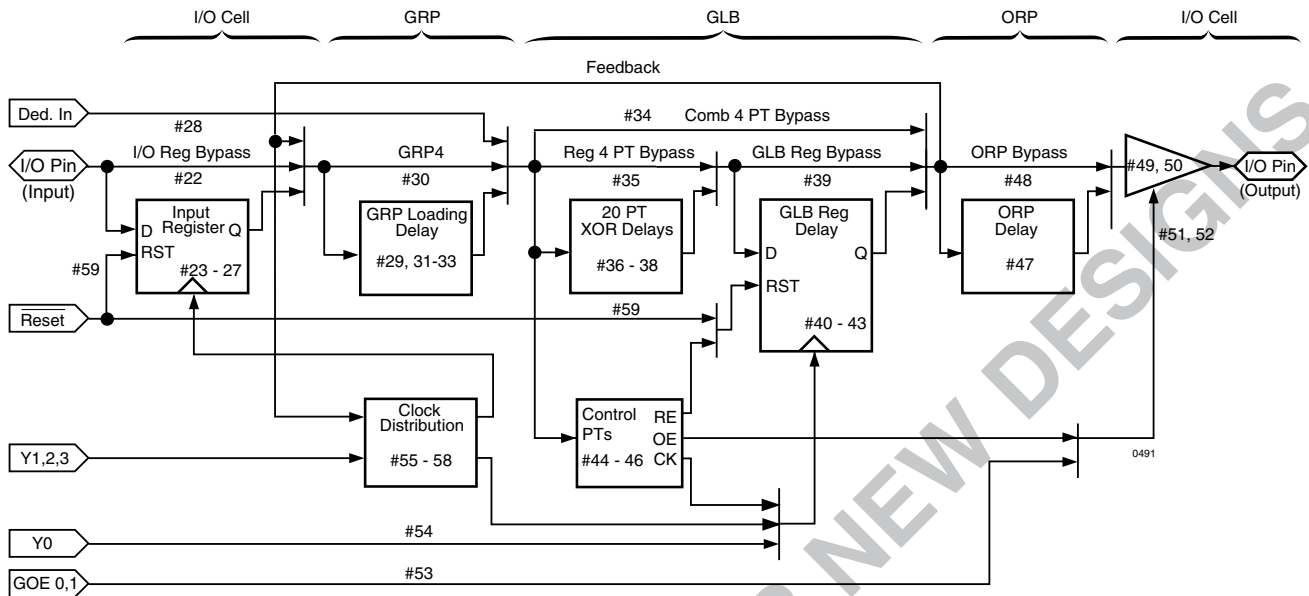

Derivations of t_{su} , t_h and t_{co} from the Product Term Clock¹

$$\begin{aligned}
 t_{su} &= \text{Logic} + \text{Reg } s_u - \text{Clock (min)} \\
 &= (t_{iobp} + t_{grp4} + t_{20ptxor}) + (t_{gsu}) - (t_{iobp} + t_{grp4} + t_{ptck(min)}) \\
 &= (\#22 + \#30 + \#37) + (\#40) - (\#22 + \#30 + \#46) \\
 2.2 \text{ ns} &= (0.3 + 2.0 + 5.0) + (0.1) - (0.3 + 2.0 + 2.9)
 \end{aligned}$$

$$\begin{aligned}
 t_h &= \text{Clock (max)} + \text{Reg } h - \text{Logic} \\
 &= (t_{iobp} + t_{grp4} + t_{ptck(max)}) + (t_{gh}) - (t_{iobp} + t_{grp4} + t_{20ptxor}) \\
 &= (\#22 + \#30 + \#46) + (\#41) - (\#22 + \#30 + \#37) \\
 3.5 \text{ ns} &= (0.3 + 2.0 + 4.0) + (4.5) - (0.3 + 2.0 + 5.0)
 \end{aligned}$$

$$\begin{aligned}
 t_{co} &= \text{Clock (max)} + \text{Reg } c_o + \text{Output} \\
 &= (t_{iobp} + t_{grp4} + t_{ptck(max)}) + (t_{gco}) + (t_{orp} + t_{ob}) \\
 &= (\#22 + \#30 + \#46) + (\#42) + (\#47 + \#49) \\
 10.9 \text{ ns} &= (0.3 + 2.0 + 4.0) + (2.3) + (1.0 + 1.3)
 \end{aligned}$$

Derivations of t_{su} , t_h and t_{co} from the Clock GLB¹

$$\begin{aligned}
 t_{su} &= \text{Logic} + \text{Reg } s_u - \text{Clock (min)} \\
 &= (t_{iobp} + t_{grp4} + t_{20ptxor}) + (t_{gsu}) - (t_{gy0(min)} + t_{gco} + t_{gcp(min)}) \\
 &= (\#22 + \#30 + \#37) + (\#40) - (\#54 + \#42 + \#56) \\
 3.4 \text{ ns} &= (0.3 + 2.0 + 5.0) + (0.1) - (0.9 + 2.3 + 0.8)
 \end{aligned}$$

$$\begin{aligned}
 t_h &= \text{Clock (max)} + \text{Reg } h - \text{Logic} \\
 &= (t_{gy0(max)} + t_{gco} + t_{gcp(max)}) + (t_{gh}) - (t_{iobp} + t_{grp4} + t_{20ptxor}) \\
 &= (\#54 + \#42 + \#56) + (\#41) - (\#22 + \#30 + \#37) \\
 2.2 \text{ ns} &= (0.9 + 2.3 + 1.8) + (4.5) - (0.3 + 2.0 + 5.0)
 \end{aligned}$$

$$\begin{aligned}
 t_{co} &= \text{Clock (max)} + \text{Reg } c_o + \text{Output} \\
 &= (t_{gy0(max)} + t_{gco} + t_{gcp(max)}) + (t_{gco}) + (t_{orp} + t_{ob}) \\
 &= (\#54 + \#42 + \#56) + (\#42) + (\#47 + \#49) \\
 9.6 \text{ ns} &= (0.9 + 2.3 + 1.8) + (2.3) + (1.0 + 1.3)
 \end{aligned}$$

1. Calculations are based upon timing specifications for the ispLSI 1048E-125.

Maximum GRP Delay vs. GLB Loads

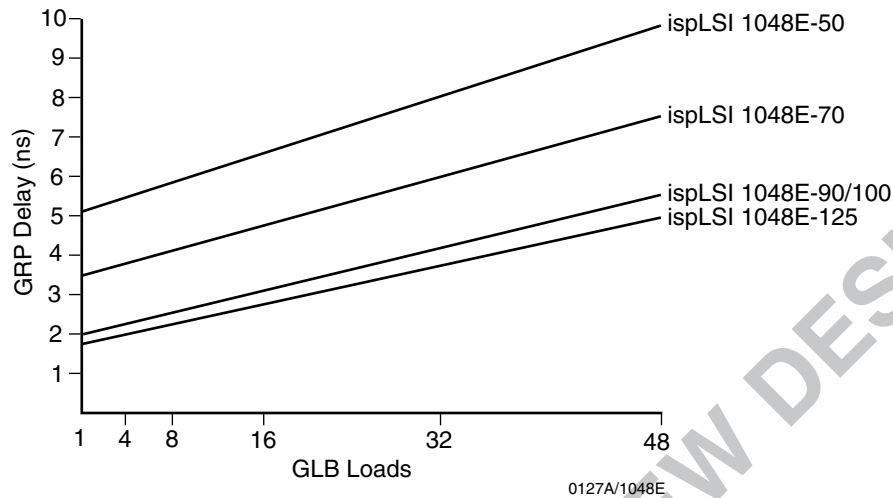

Power Consumption

Power consumption in the ispLSI 1048E device depends on two primary factors: the speed at which the device is operating and the number of Product Terms used.

Figure 3 shows the relationship between power and operating speed.

Figure 3. Typical Device Power Consumption vs fmax

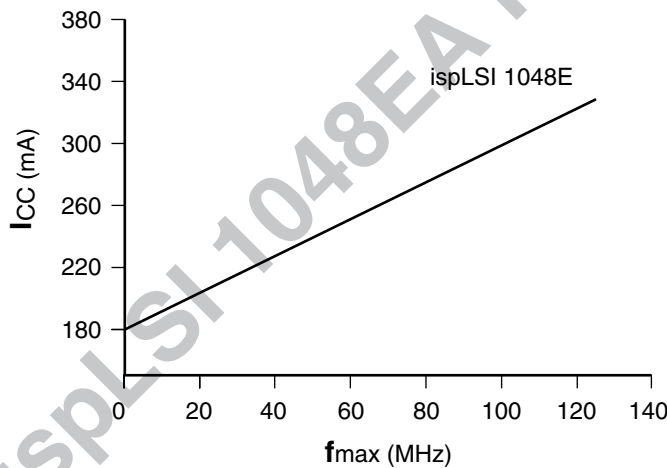

Notes: Configuration of twelve 16-bit counters,
Typical current at 5V, 25°C

ICC can be estimated for the ispLSI 1048E using the following equation:

$$I_{CC} = 20 + (\# \text{ of PTs} * 0.42) + (\# \text{ of nets} * \text{Max. freq} * 0.010)$$

Where:

- # of PTs = Number of Product Terms used in design
- # of nets = Number of Signals used in device
- Max. freq = Highest Clock Frequency to the device

The ICC estimate is based on typical conditions (VCC = 5.0V, room temperature) and an assumption of 4 GLB loads on average exists. These values are for estimates only. Since the value of ICC is sensitive to operating conditions and the program in the device, the actual ICC should be verified.

0127B/1048E

Pin Description

NAME	PQFP / TQFP PIN NUMBERS	DESCRIPTION
I/O 0 - I/O 5 I/O 6 - I/O 11 I/O 12 - I/O 17 I/O 18 - I/O 23 I/O 24 - I/O 29 I/O 30 - I/O 35 I/O 36 - I/O 41 I/O 42 - I/O 47 I/O 48 - I/O 53 I/O 54 - I/O 59 I/O 60 - I/O 65 I/O 66 - I/O 71 I/O 72 - I/O 77 I/O 78 - I/O 83 I/O 84 - I/O 89 I/O 90 - I/O 95	21, 22, 23, 24, 25, 26, 27, 28, 29, 30, 31, 32, 34, 35, 36, 37, 38, 39, 40, 41, 42, 43, 44, 45, 52, 53, 54, 55, 56, 57, 58, 59, 60, 61, 62, 63, 66, 67, 68, 69, 70, 71, 72, 73, 74, 75, 76, 77, 85, 86, 87, 88, 89, 90, 91, 92, 93, 94, 95, 96, 98, 99, 100, 101, 102, 103, 104, 105, 106, 107, 108, 109, 117, 118, 119, 120, 121, 122, 123, 124, 125, 126, 127, 128, 2, 3, 4, 5, 6, 7, 8, 9, 10, 11, 12, 13	Input/Output Pins - These are the general purpose I/O pins used by the logic array.
GOE0, GOE1	64, 114	Global Output Enable input pins.
IN 2, IN 4 IN 6 - IN 11	47, 51 84, 110, 111, 115, 116, 14	Dedicated input pins to the device.
$\overline{\text{ispEN}}$	18	Input - Dedicated in-system programming enable input pin. This pin is brought low to enable the programming mode. When low, the MODE, SDI, SDO and SCLK controls become active.
SDI/IN 0 ¹	20	Input - This pin performs two functions. When $\overline{\text{ispEN}}$ is logic low, it functions as an input pin to load programming data into the device. SDI/IN 0 also is used as one of the two control pins for the ISP state machine. When $\overline{\text{ispEN}}$ is high, it functions as a dedicated input pin.
MODE/IN 1 ¹	46	Input - This pin performs two functions. When $\overline{\text{ispEN}}$ is logic low, it functions as pin to control the operation of the isp state machine. When $\overline{\text{ispEN}}$ is high, it functions as a dedicated input pin.
SDO/IN 3 ¹	50	Output/Input - This pin performs two functions. When $\overline{\text{ispEN}}$ is logic low, it functions as an output pin to read serial shift register data. When $\overline{\text{ispEN}}$ is high, it functions as a dedicated input pin.
SCLK/IN 5 ¹	78	Input - This pin performs two functions. When $\overline{\text{ispEN}}$ is logic low, it functions as a clock pin for the Serial Shift Register. When $\overline{\text{ispEN}}$ is high, it functions as a dedicated input pin.
$\overline{\text{RESET}}$	19	Active Low (0) Reset pin which resets all of the GLB and I/O registers in the device.
Y0	15	Dedicated Clock input. This clock input is connected to one of the clock inputs of all of the GLBs on the device.
Y1	83	Dedicated Clock input. This clock input is brought into the clock distribution network, and can optionally be routed to any GLB on the device.
Y2	80	Dedicated Clock input. This clock input is brought into the clock distribution network, and can optionally be routed to any GLB and/or any I/O cell on the device.
Y3	79	Dedicated Clock input. This clock input is brought into the clock distribution network, and can optionally be routed to any I/O cell on the device.
GND	1, 17, 33, 49, 65, 81, 97, 112	Ground (GND)
VCC	16, 48, 82, 113	V _{CC}

1. Pins have dual function capability.

Pin Configuration

ispLSI 1048E 128-Pin PQFP Pinout Diagram

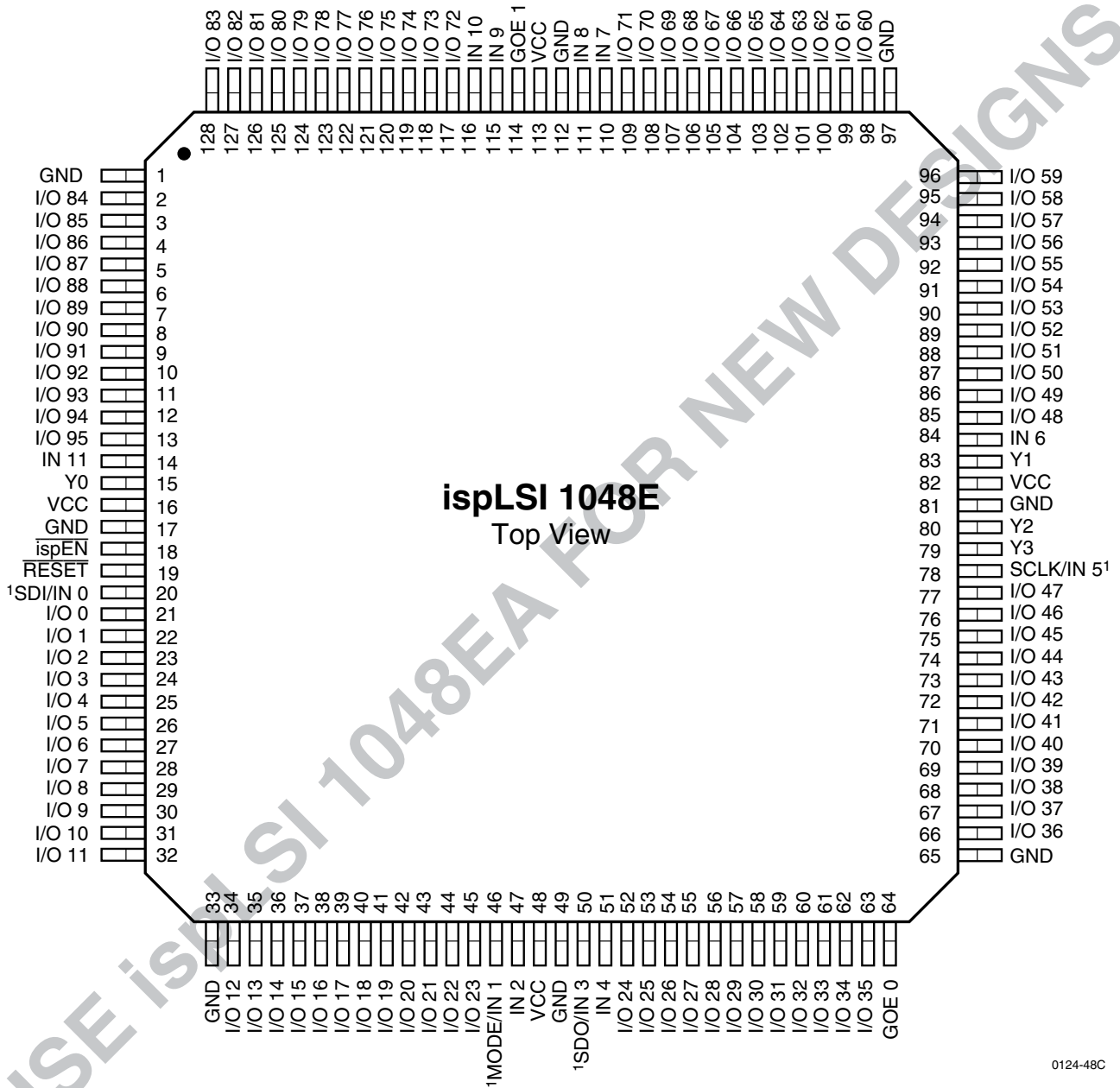

1. Pins have dual function capability.

Pin Configuration

ispLSI 1048E 128-Pin TQFP Pinout Diagram

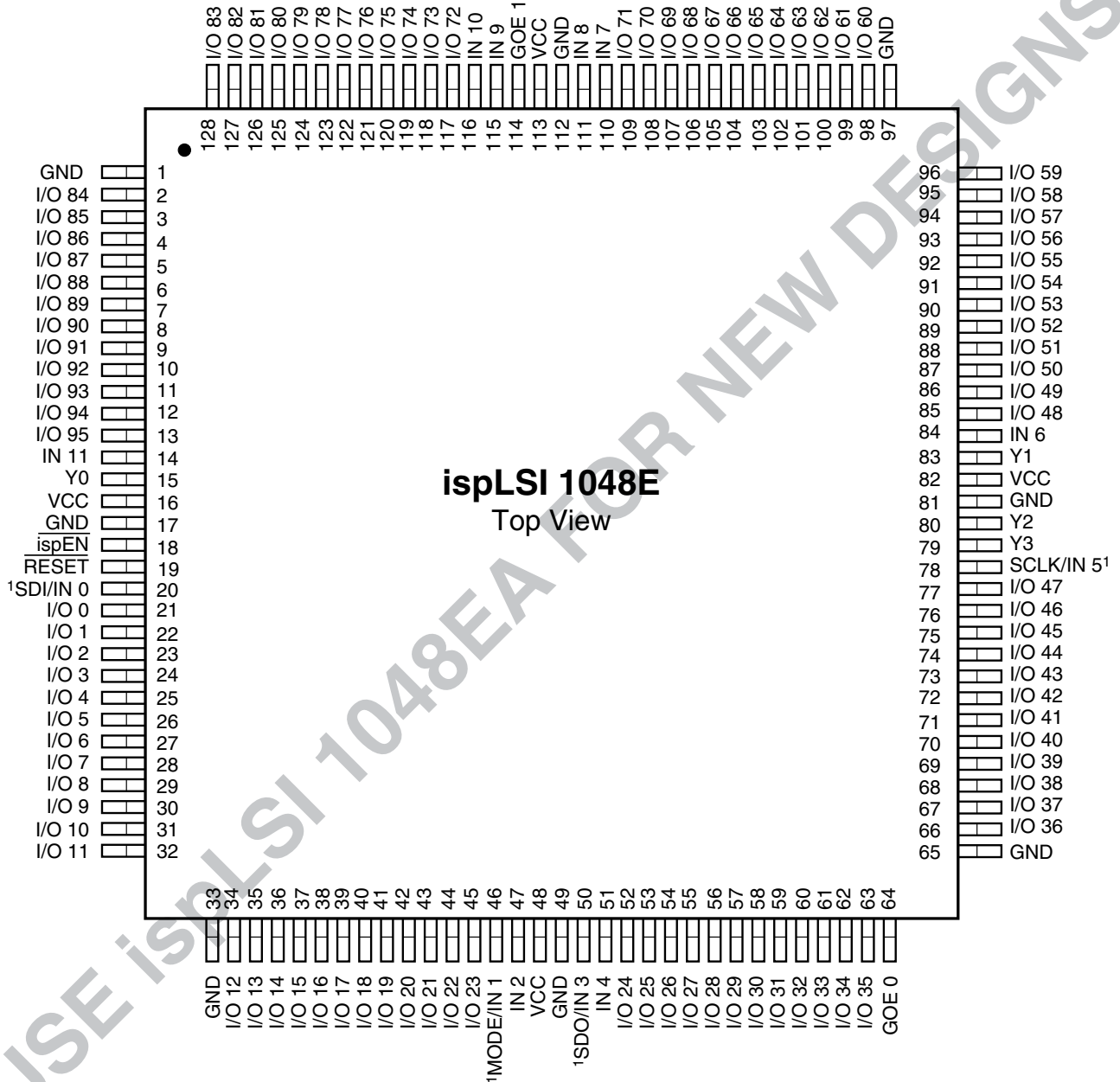

1. Pins have dual function capability.

Package Thermal Characteristics

For the ispLSI 1048E-125LT, it is strongly recommended that the actual I_{CC} be verified to ensure that the maximum junction temperature (T_J) with power supplied is not exceeded. Depending on the specific logic design and clock speed, airflow may be required to satisfy the maxi-

mum allowable junction temperature (T_J) specification. Please refer to the Thermal Management section of the Lattice Semiconductor Data Book or CD-ROM for additional information on calculating T_J .

Part Number Description

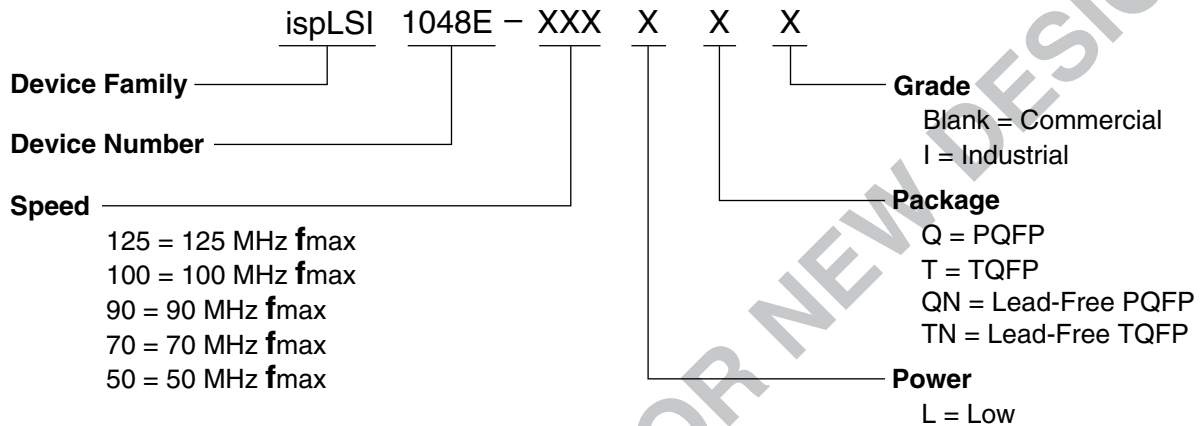

ispLSI 1048E Ordering Information

Conventional Packaging

COMMERCIAL

FAMILY	f_{max} (MHz)	t_{pd} (ns)	ORDERING NUMBER	PACKAGE
ispLSI	125	7.5	ispLSI 1048E-125LQ	128-Pin PQFP
	125	7.5	ispLSI 1048E-125LT	128-Pin TQFP
	100	10	ispLSI 1048E-100LQ	128-Pin PQFP
	100	10	ispLSI 1048E-100LT	128-Pin TQFP
	90	10	ispLSI 1048E-90LQ	128-Pin PQFP
	90	10	ispLSI 1048E-90LT	128-Pin TQFP
	70	15	ispLSI 1048E-70LQ	128-Pin PQFP
	70	15	ispLSI 1048E-70LT	128-Pin TQFP
	50	20	ispLSI 1048E-50LQ	128-Pin PQFP
	50	20	ispLSI 1048E-50LT	128-Pin TQFP

Table 2-0041A/1048E

INDUSTRIAL

FAMILY	f_{max} (MHz)	t_{pd} (ns)	ORDERING NUMBER	PACKAGE
ispLSI	70	15	ispLSI 1048E-70LQI*	128-Pin PQFP
	50	20	ispLSI 1048E-50LQI*	128-Pin PQFP

*Use 1048E-70 for new 1048E-50 designs.

Table 2-0041B/1048E

ispLSI 1048E Ordering Information (Cont.)
Lead-Free Packaging
COMMERCIAL

FAMILY	fmax (MHz)	tpd (ns)	ORDERING NUMBER	PACKAGE
ispLSI	125	7.5	ispLSI 1048E-125LQN	Lead-Free 128-Pin PQFP
	125	7.5	ispLSI 1048E-125LTN	Lead-Free 128-Pin TQFP
	100	10	ispLSI 1048E-100LQN	Lead-Free 128-Pin PQFP
	100	10	ispLSI 1048E-100LTN	Lead-Free 128-Pin TQFP
	90	10	ispLSI 1048E-90LQN	Lead-Free 128-Pin PQFP
	90	10	ispLSI 1048E-90LTN	Lead-Free 128-Pin TQFP
	70	15	ispLSI 1048E-70LQN	Lead-Free 128-Pin PQFP
	70	15	ispLSI 1048E-70LTN	Lead-Free 128-Pin TQFP
	50	20	ispLSI 1048E-50LQN	Lead-Free 128-Pin PQFP
50	20	ispLSI 1048E-50LTN	Lead-Free 128-Pin TQFP	

INDUSTRIAL

FAMILY	fmax (MHz)	tpd (ns)	ORDERING NUMBER	PACKAGE
ispLSI	70	15	ispLSI 1048E-70LQNI	Lead-Free 128-Pin PQFP

Revision History

Date	Version	Change Summary
—	11	Previous Lattice release.
August 2006	12	Updated for lead-free package options.

X-ON Electronics

Largest Supplier of Electrical and Electronic Components

Click to view similar products for [CPLD - Complex Programmable Logic Devices](#) category:

Click to view products by [Lattice](#) manufacturer:

Other Similar products are found below :

[5962-9952001QYA](#) [5M1270ZT144I5](#) [M4A5-12864-10YNI](#) [M4A5-12864-12YNI](#) [M4A5-3232-5VNC](#) [M4A5-6432-7VNC](#) [M4A5-6432-7VNI](#)
[CY3LV002-10JC](#) [CY7C344B-15JI](#) [EPM7064LC68-10](#) [ISPLSI 1032-90LJ](#) [ISPLSI 1048-70LQ](#) [LA4064V-75TN44E](#) [LC4064ZC-5MN56C](#)
[M4A3-3232-10VC](#) [M4A5-256128-12YNI](#) [MACH435Q-20JC](#) [ISPLSI 1032-60LJ](#) [ISPLSI 1032-80LJ](#) [ISPLSI 1048-50LQ](#) [LA4032V-75TN44E](#)
[LC4032ZC-5MN56I](#) [5962-9759901QZC](#) [XC95288XL-10CS280I](#) [LC4032ZC-75MN56I](#) [LC5512MV-45F256C](#) [M4A5-6432-10VNI](#)
[ISPLSI2096A-80LT128I](#) [M4A3-256192-10FAI](#) [LA4128V-75TN128E](#) [ISPLSI5256VA-100LB208](#) [M4A3-3232-5VC48](#) [M4A3-64/32-](#)
[12VNI48](#) [CP4878DM](#) [M4A3-256/160-7YC](#) [M4A3-256/192-7FAC](#) [M4A3-32/32-10VNC48](#) [M4A3-384/192-10FANC](#) [M4A3-512/160-14YI](#)
[M4A3-512/192-7FAC](#) [M4A3-64/32-10VNC](#) [M4A5-128/64-7YI](#) [M4A5-192/96-10VC](#) [M4A5-192/96-10VI](#) [M4A5-256/128-10YNC](#) [M4A5-](#)
[256/128-7YC](#) [M4A5-32/32-10VC](#) [M4A5-64/32-10VNC](#) [M5-192/120-10YI/1](#) [M5-320/160-10YI](#)