



MachXO2-4000HC Control Development Kit

User Guide

Introduction

Thank you for choosing the Lattice Semiconductor MachXO2™-4000HC Control Development Kit!

This guide describes how to start using the MachXO2-4000HC Control Development Kit, an easy-to-use platform for rapidly prototyping system control designs using MachXO2 PLDs. Along with the evaluation board and accessories, this kit includes a pre-loaded control system-on-chip (Control SoC) design that demonstrates board diagnostic functions including I/O control, voltage monitoring, time-stamps and data logging to non-volatile memory. The Power Manager II ispPAC®-POWR1014A and 8-bit LatticeMico8™ microcontroller are featured in the board and demonstration design.

The contents of this user's guide include demo operation, top-level functional descriptions of the various portions of the evaluation board, descriptions of the on-board connectors, switches, a complete set of schematics and bill of materials for the MachXO2-4000HC Control Evaluation Board.

Note: Static electricity can severely shorten the lifespan of electronic components. See the MachXO2-4000HC Control Development Kit QuickSTART Guide for handling and storage tips.

Features

The MachXO2-4000HC Control Development Kit includes:

- **MachXO2-4000HC Control Evaluation Board** – The MachXO2-4000HC Control Evaluation Board features the following on-board components and circuits:
 - MachXO2 LCMXO2-4000HC-csBGA132 PLD
 - Power Manager II POWR1014A mixed-signal PLD
 - 4 Mbit SPI Flash memory
 - microSD (micro Secure Digital) memory socket
 - Current and voltage sensor circuits
 - Voltage ramp circuits
 - Electret microphone
 - Audio amplifier and Delta-Sigma ADC
 - PWM analog output circuit
 - Audio output channel
 - Up to two DVI sources and one DVI output
 - Up to two 7:1 LVDS sources and one 7:1:VDS output (e.g. Camera Link)
 - Expansion header for JTAG, SPI, I²C and PLD I/Os
 - LEDs and switches
 - Standard USB cable for device programming
 - RS-232/USB and JTAG/USB interface
 - RoHS-compliant packaging and process
 - AC adapter (international plugs)
- **Pre-loaded Reference Designs and Demo** – The kit includes the pre-loaded Control SoC demo design that integrates several Lattice reference designs including: the LatticeMico8 microcontroller, master WISHBONE bus controller, soft Delta-Sigma ADC, SPI master controller, UART peripheral, Embedded Block RAM and additional control functions.
- **USB connector Cable** – A mini B USB port provides a communication and debug port via a USB-to-RS-232 physical channel and programming interface to the MachXO2 JTAG port.
- **AC Adapter** (international plugs) with 5 V DC output, center positive.
- **QuickSTART Guide** – Provides information on connecting the MachXO2-4000HC Control Evaluation Board, installing Windows hardware drivers, and running the Control SoC demo.

Figure 1 shows the top side of the MachXO2-4000HC Control Evaluation Board with comments on the specific features that are designed in the board.

Figure 1. MachXO2-4000HC Control Evaluation Board, Top Side

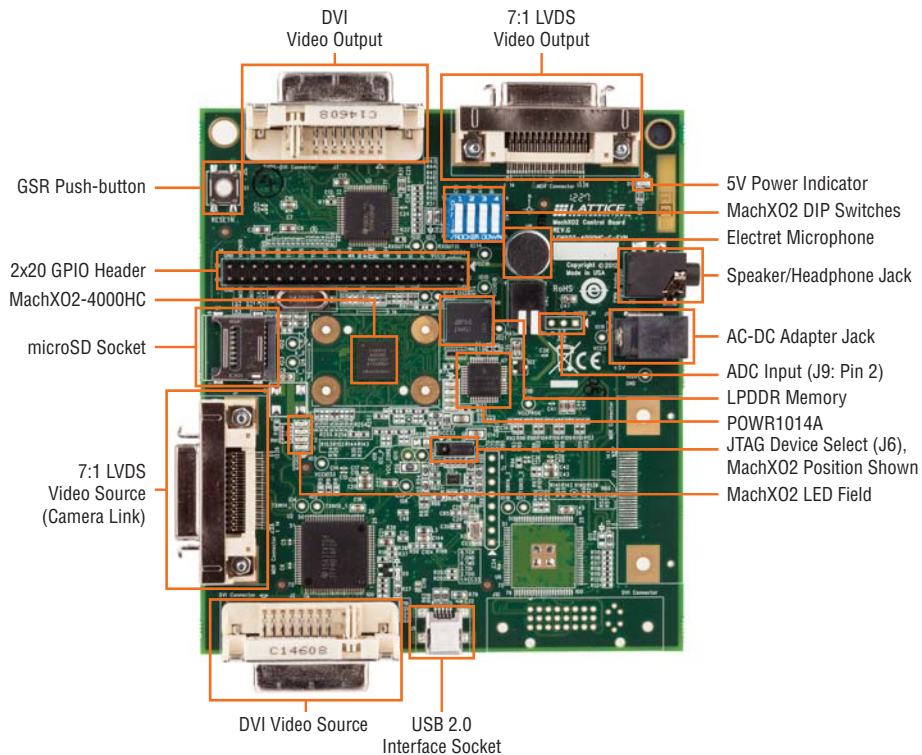

Notes:

- Video Source 1 is available in both DVI and 7:1 LVDS interfaces. Video Source 2 is not populated.
- An LPDDR memory device is installed on the PCB, but performance is limited to 20 MHz max.

Lattice Semiconductor Devices

MachXO2

This board features a 3.3 V MachXO2 PLD packaged in a 132-ball csBGA package. This package allows density migration to devices from 256 to 4340 LUTs. A complete description of this device can be found in DS1035, [MachXO2 Family Data Sheet](#).

Power Manager II

This board also features a Power Manager II mixed-signal PLD. The POWR1014A device serves as a general-purpose power supply monitor, reset generator, sequence controller, and high-voltage FET drivers. More information about Power Manager II devices can be found on the Lattice web site at www.latticesemi.com/products/powermanager.

Software Requirements

You should install Lattice Diamond® design software version 2.0 (or higher) before you begin developing designs for the evaluation board.

Control SoC Demonstration Design

The Control System-on-Chip (SoC) demonstration illustrates the use of the LatticeMico8 microcontroller, peripherals, and firmware integrated to provide system control features such as power supply sequencing, voltage monitoring, data logging to nonvolatile memory, I/O control, embedded block RAM utilization, UART communication and PLL status monitoring.

- The Power Manager II device sequences the power-up of voltage rails on the board and performs reset distribution.
- LatticeMico8 executable program initializes the peripherals that are embedded in the SoC design. During initialization, LatticeMico8 uploads the user menu on a Terminal emulator (such as HyperTerminal, Tera Term) of a PC.
- Users interact with LatticeMico8 and the board through the Terminal emulator of a PC.

Figure 2. Control SoC Demo Block Diagram

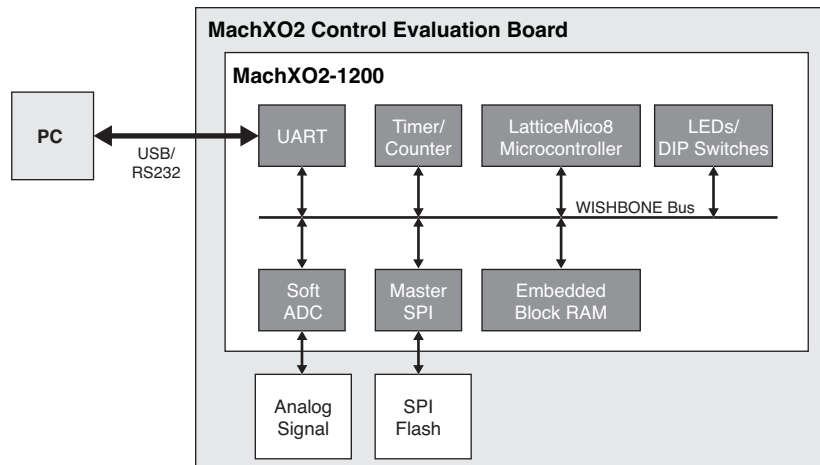

Power management is handled in two phases by the MachXO2-4000HC Control Evaluation Board system:

1. **Power On** – After power is supplied to the board and the 3.3 V rail is stable, the POWR1014A sequences four supply rails. Two circuits demonstrate the voltage ramp of 2N7002E power MOSFETs using the high-voltage (HVOUT) outputs and two demonstrate power rail enable of VCC_CORE and VCCP of the MachXO2 using digital outputs. Next, the POWR1014A asserts the MachXO2 reset. Finally, the POWR1014A enters a supply monitoring state.
2. **Post Power On** – During the second phase of power management, the board’s “condition” is monitored. Power supply rail voltage, and current is monitored by the POWR1014A. If any supply rail fails, the POWR1014A asserts a reset for the MachXO2.

MachXO2 Function – After the reset is de-asserted, LatticeMico8 initializes the peripherals embedded in the MachXO2 device and uploads the user menu onto the Terminal emulator window of a PC.

Figure 3. HyperTerminal User Menu

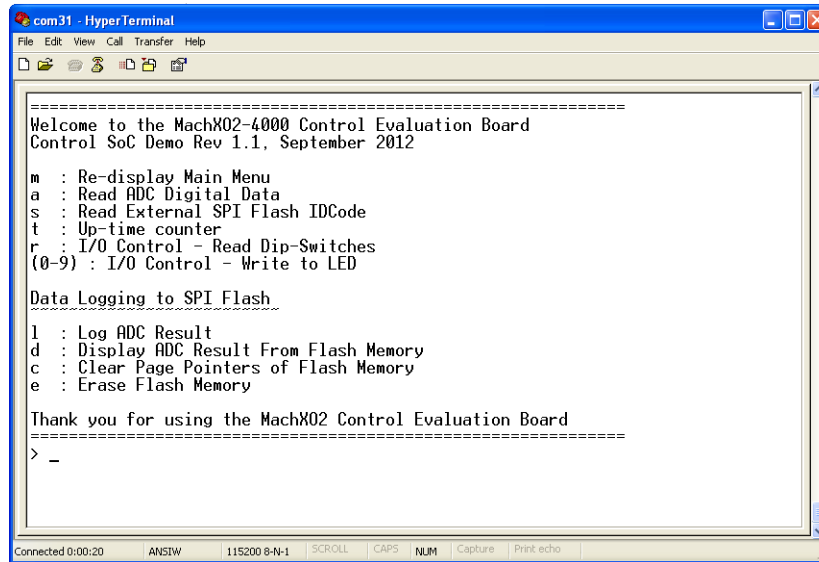

Users interact with LatticeMico8 microcontroller and the board by selecting the available options in the Terminal emulator menu. The available options are:

- **'m'** – This option will re-display the main menu anytime during the demonstration.
- **'a'** – This option will sample the voltage in the pin #2 of header J9. By default, the node is biased at 1.65 V, which is half of the VCCIO = 3.30 V. The voltage will be displayed in the HyperTerminal window. The ADC input voltage should be limited to the range 0 to 3.0 V to avoid device damage.
- **'s'** – This option will read the device ID of the SPI Flash on the board and display it in the HyperTerminal. The resulting ID is hexadecimal 0x44, which corresponds to AT25DF041A device.
- **'t'** – This option samples and displays the elapsed time since the reset was de-asserted.
- **'r'** - This option samples the DIP switches (reference designator SW1) on the board and displays the data in the HyperTerminal. Users can change the DIP switches on the board and press 'r' to display the new value.
- **"0-9"** – These are BCD numerical values that can be typed on the keyboard. The value will be received by LatticeMico8, which will update the LEDs (D0-D3) on the board.
- **'l'** – This is a lower case 'l' character. Pressing 'l' will sample the voltage in pin #2 of header J9 and log the data in the SPI Flash device on the board. The WRITE page pointer will increment when 'l' is pressed. The initial value of the page pointer after power-up or after a reset is 0.
- **'d'** – This option will read the data from SPI Flash device and display it on the HyperTerminal window. The READ page pointer will increment when 'd' is pressed. The initial value of the page pointer after power-up or after a reset is 0.
- **'c'** – This option will clear (reset) the WRITE and READ page pointers.
- **'e'** – This selection will perform a bulk-erase of the Flash memory in the SPI Flash device.

Setting up the Board

Drivers and Firmware

Before you begin, you will need to obtain the necessary hardware drivers for Windows from the Lattice web site.

1. Browse to the www.latticesemi.com/MachXO2-control-kit and locate the hardware device drivers for the USB interface.
2. Download the ZIP file to your system and unzip it to a location on your PC.

Linux Support:

The USB interface drivers for the evaluation board are included in Linux kernel 2.4.20 or greater including distributions compatible with Lattice Diamond design software (Red Hat Enterprise v.3, v.4 or Novell SUSE Enterprise v.10).

The Control SoC Demo is preprogrammed into the MachXO2-4000HC Control Evaluation Board, however over time it is likely that your board will be modified.

To download the demo source files and reprogram the MachXO2-4000HC Control Evaluation Board:

1. Download demo application source code from www.latticesemi.com/mx02-control-kit.
2. Use `.IDemo_MachXO2_Control_SoC\project\control_soc_demo.jed` to restore the MachXO2-4000HC Control SoC demo design.
3. Use `.IDemo_PM_Control_BM\project\bm_demo.jed` to restore the POWR1014A Board Management demo design.

Connecting to the MachXO2-4000HC Control Evaluation Board

1. Plug the AC-DC adapter to an outlet.
2. Power the board by inserting the AC-DC adapter into the power jack with reference designator J11. Once the connection is made, a red LED with reference designator D12 will illuminate.
3. Connect the evaluation board to your PC using the USB cable provided. The USB connector in the board has reference designator J5.
4. If you are prompted, "Windows may connect to Windows Update", select **No, not this time** from available options and click **Next** to proceed with the installation.
5. Choose the **Install from specific location (Advanced)** option and click **Next**.
6. Select **Search for the best driver in these locations** and click the **Browse** button to browse to the Windows driver folder created earlier. Select the **CDM 2.04.06 WHQL Certified** folder and click **OK**.
7. Click **Next**. A screen will display as Windows copies the required driver files. Windows will display a message indicating that the installation was successful.

Programming the PLDs

The three-pin header with reference designator J6 is used to select between the JTAG port of the MachXO2 or POWR1014A device. Installing a jumper in pins 1 and 2 of J6 will select the JTAG port of the POWR1014A device. Installing a jumper in pins 2 and 3 of J6 will select the JTAG port of the MachXO2 device.

Pin 1 of header J6 is marked on the silkscreen of the board with a white triangle as shown in Figure 4. This example shows the jumper installed in pins 2 and 3 of the J6 header and the JTAG port of the MachXO2 device has been selected.

Figure 4. J6 Header Used for Selecting the JTAG Port of the PLDs



Using Diamond Programmer software (included with the Diamond installation), users can scan and perform JTAG operations, including programming, with the MachXO2 and POWR1014A devices.

Setting Up Windows HyperTerminal

You will use a terminal emulator program to communicate with the evaluation board. The following instructions describe the Windows HyperTerminal program which is found on most Windows PCs. You may use another terminal program if desired although setup will be different. Windows 7 does not include HyperTerminal. Tera Term has been verified to work with Windows 7. For Linux, Minicom is a good alternative.

Note: This step uses the procedure for Windows XP users. Steps may vary slightly if using another Windows version.

1. From the **Start** menu, select **Control Panel > System**. The “System Properties” dialog appears.
2. Select the **Hardware** tab and click **Device Manager**. The “Device Manager” dialog appears.

Figure 5. Device Manager – COM Port

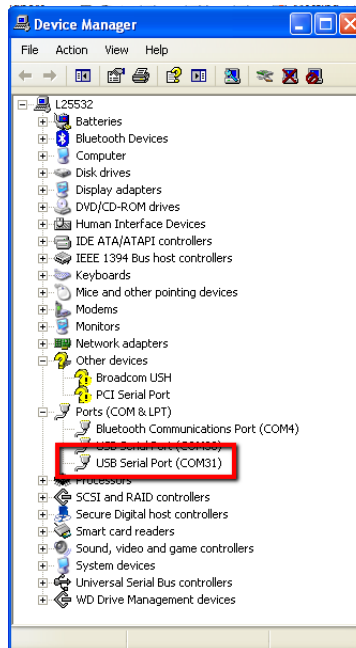

3. Expand the **Ports (COM & LPT)** entry and note the COM port number for the USB Serial Port.
4. From the **Start** menu, select **Programs > Accessories > Communications > HyperTerminal**. The HyperTerminal application and a “Connection Description” dialog appear.

Figure 6. New Connection – COM Port



5. Specify a Name and Icon for the new connection. Click **OK**. The “Connect To” dialog appears.
6. Select the COM port identified in Step 3 from the Connect using: list. Click **OK**.

Figure 7. Selecting the COM Port



7. The “COMn Properties” dialog appears where n is the COM port selected from the list.
8. Select the following Port Settings and click **OK**.
 - Bits per second: **115200**
 - Data bits: **8**
 - Parity: **None**
 - Stop bits: **1**
 - Flow control: **None**

Figure 8. COM Port Properties

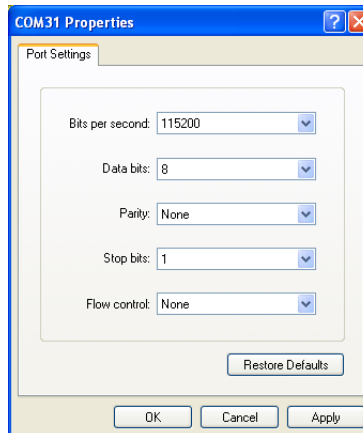

9. The HyperTerminal window appears.
10. From the MachXO2-4000HC Control Evaluation Board, press the reset push-button with reference designator S1. The Control SoC demo main menu appears.

Setting Up Linux Minicom

Minicom is a terminal program found with most Linux distributions. It can be used to communicate with the MachXO2-4000HC Control Evaluation Board.

To setup Minicom:

1. Check active serial ports:

```
#dmesg | grep tty
```

Note the tty label assigned to the USB port

2. From a command prompt, start Minicom:

```
#minicom -s
```

The configuration menu appears.

3. Highlight Serial port setup and press **Enter**. Serial port settings appear.
4. Press **A** (Serial Device). Specify the active serial device noted in Step 1 and press **Enter**.
5. Press **E** (Bps/Par/Bits). Specify **115200**, **None**, **8** and press **Enter**.
6. Press **F** (Hardware Flow Control). Specify **None** and press **Enter**.
7. Press **Esc**. The configuration menu appears.
8. Select **Save setup as dfl**. Minicom saves the port setup as the new default.
9. Select **Exit**. The Minicom interface appears.
10. From the evaluation board, press the **S1** push-button (GSR).The Control SoC demo main menu appears.

Ordering Information

Description	Ordering Part Number	China RoHS Environment-Friendly Use Period (EFUP)
MachXO2-4000HC Control Development Kit	LCMXO2-4000HC-C-EVN	

Technical Support Assistance

e-mail: techsupport@latticesemi.com

Internet: www.latticesemi.com

Revision History

Date	Version	Change Summary
March 2015	1.2	Updated Features section. Added “center positive” to AC Adapter description.
		Updated Technical Support Assistance information.
November 2013	01.1	Removed LPDDR from features list, added performance note.
October 2012	01.0	Initial release.

© 2015 Lattice Semiconductor Corp. All Lattice trademarks, registered trademarks, patents, and disclaimers are as listed at www.latticesemi.com/legal. All other brand or product names are trademarks or registered trademarks of their respective holders. The specifications and information herein are subject to change without notice.

Appendix A. Schematic

Figure 9. Architecture

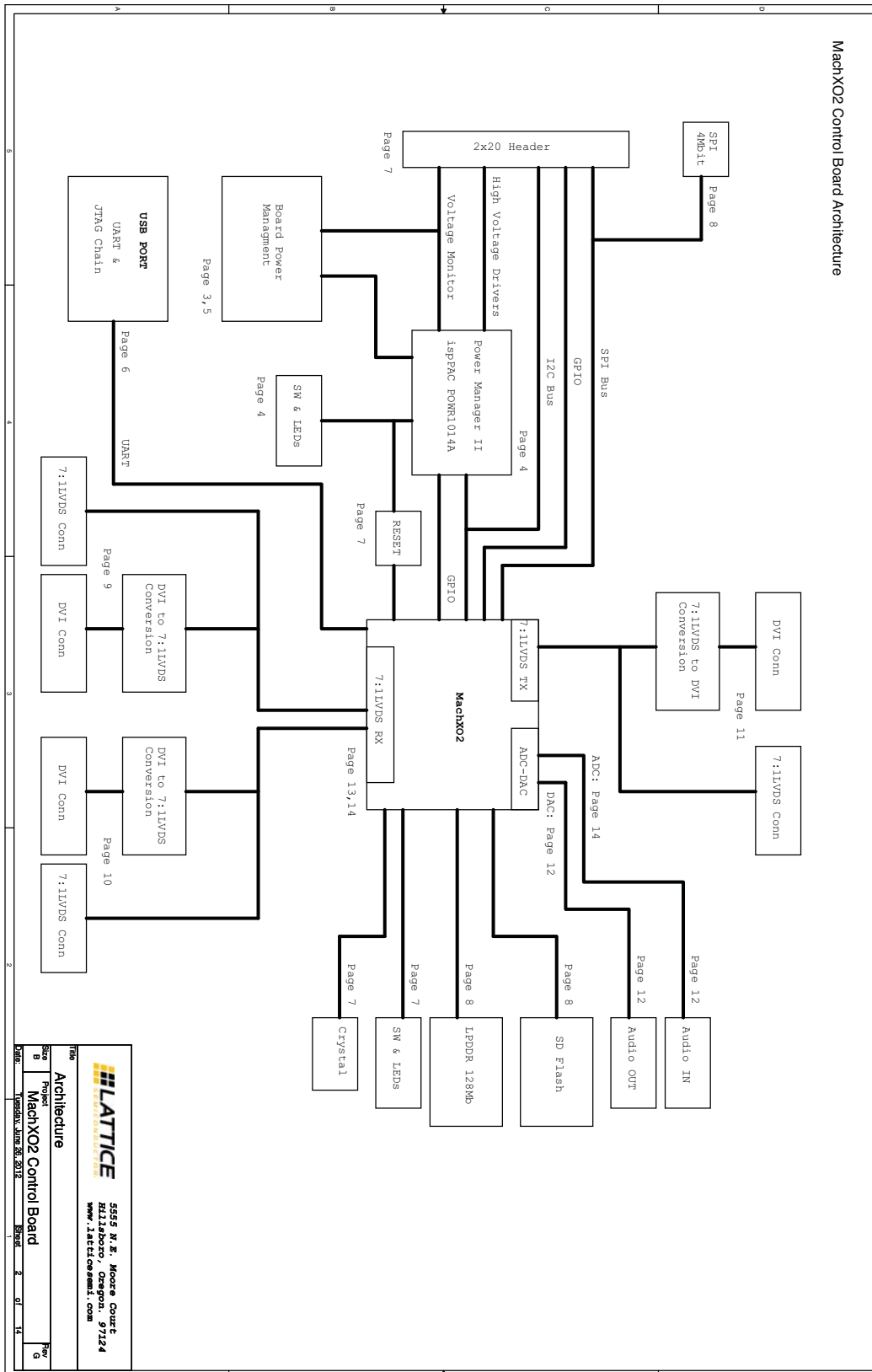

Figure 10. Power, VCC33, VCC18, VCC12

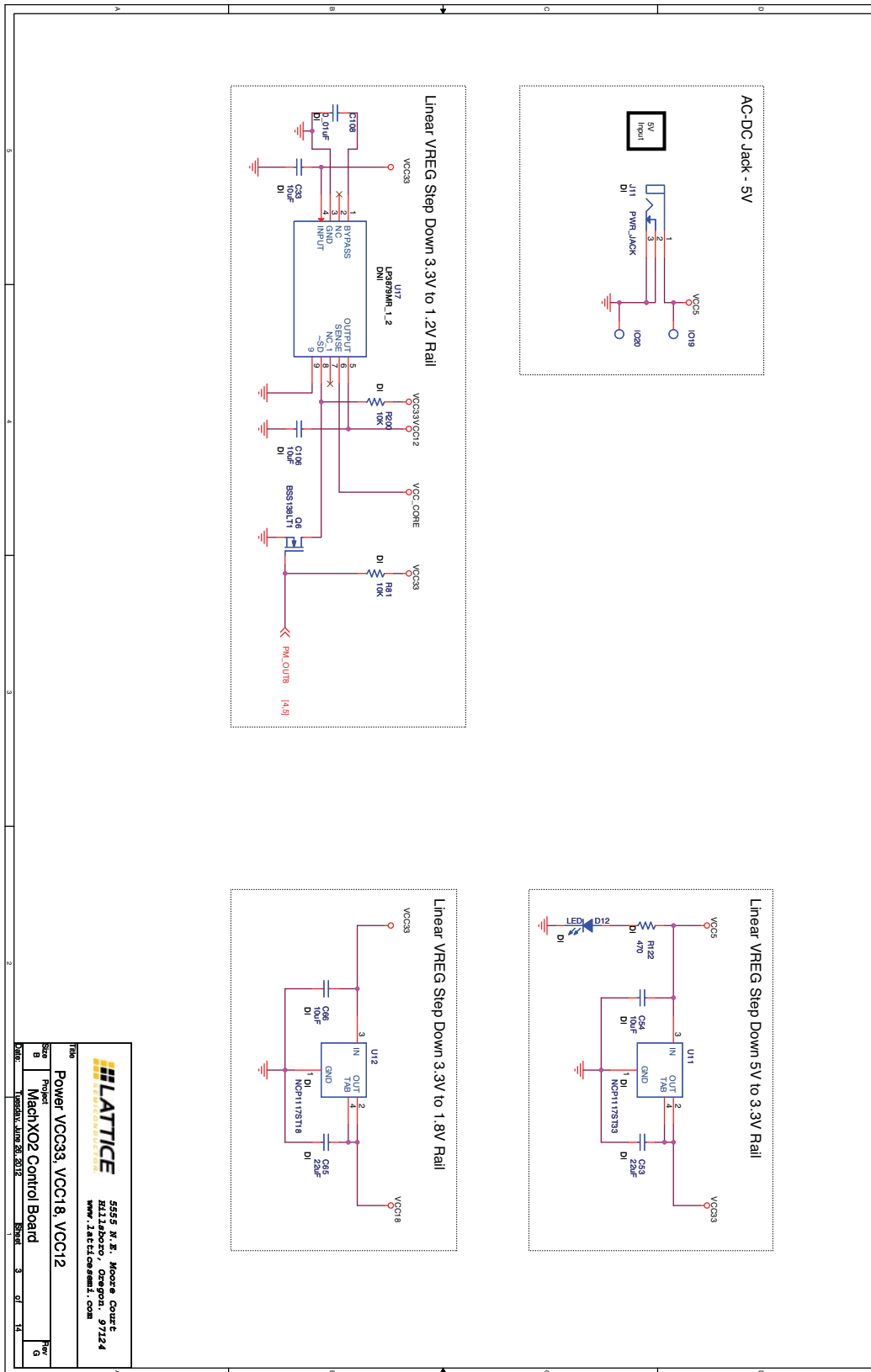

Figure 13. Configuration USB Port

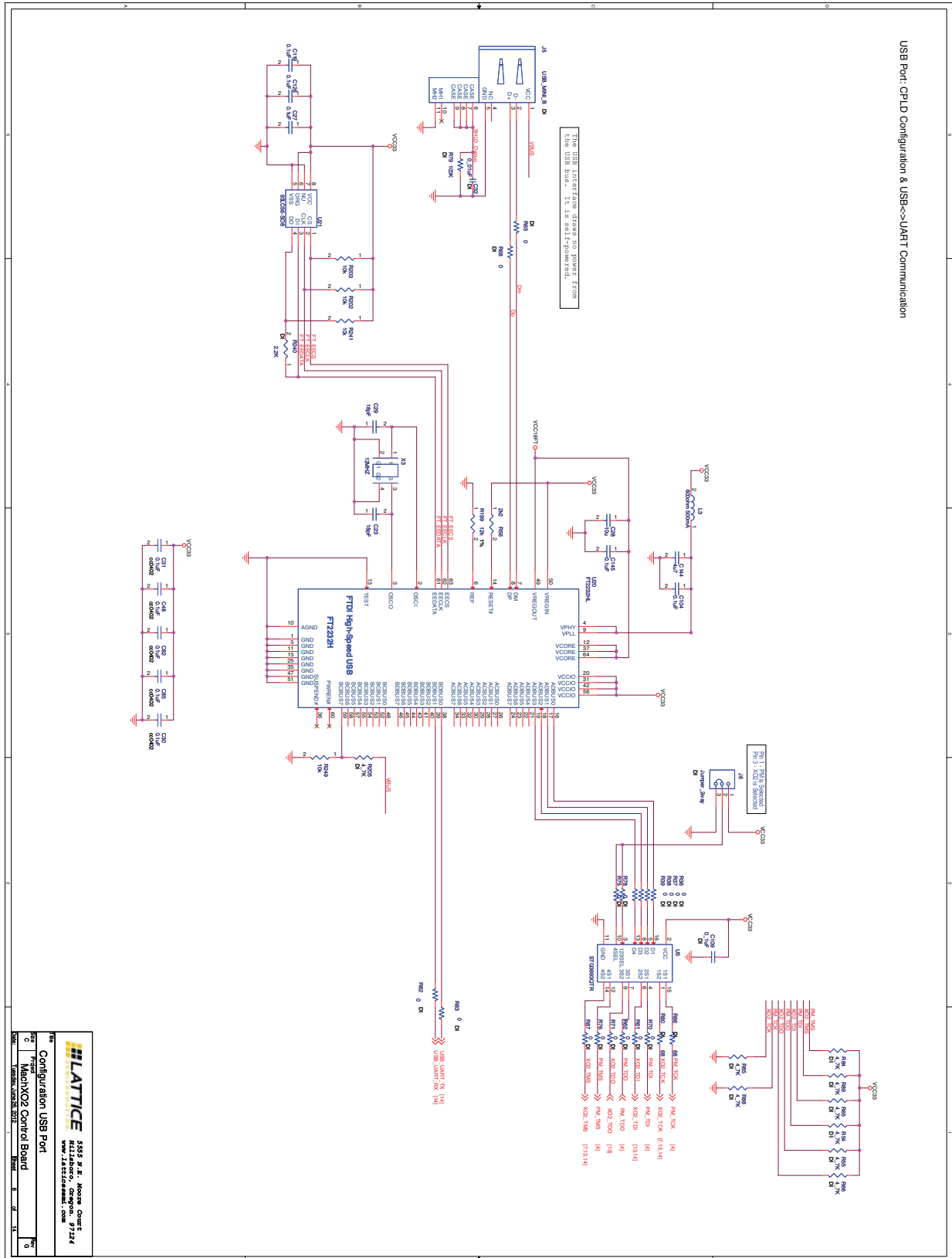

Figure 14. Software, LED, Crystal, Header

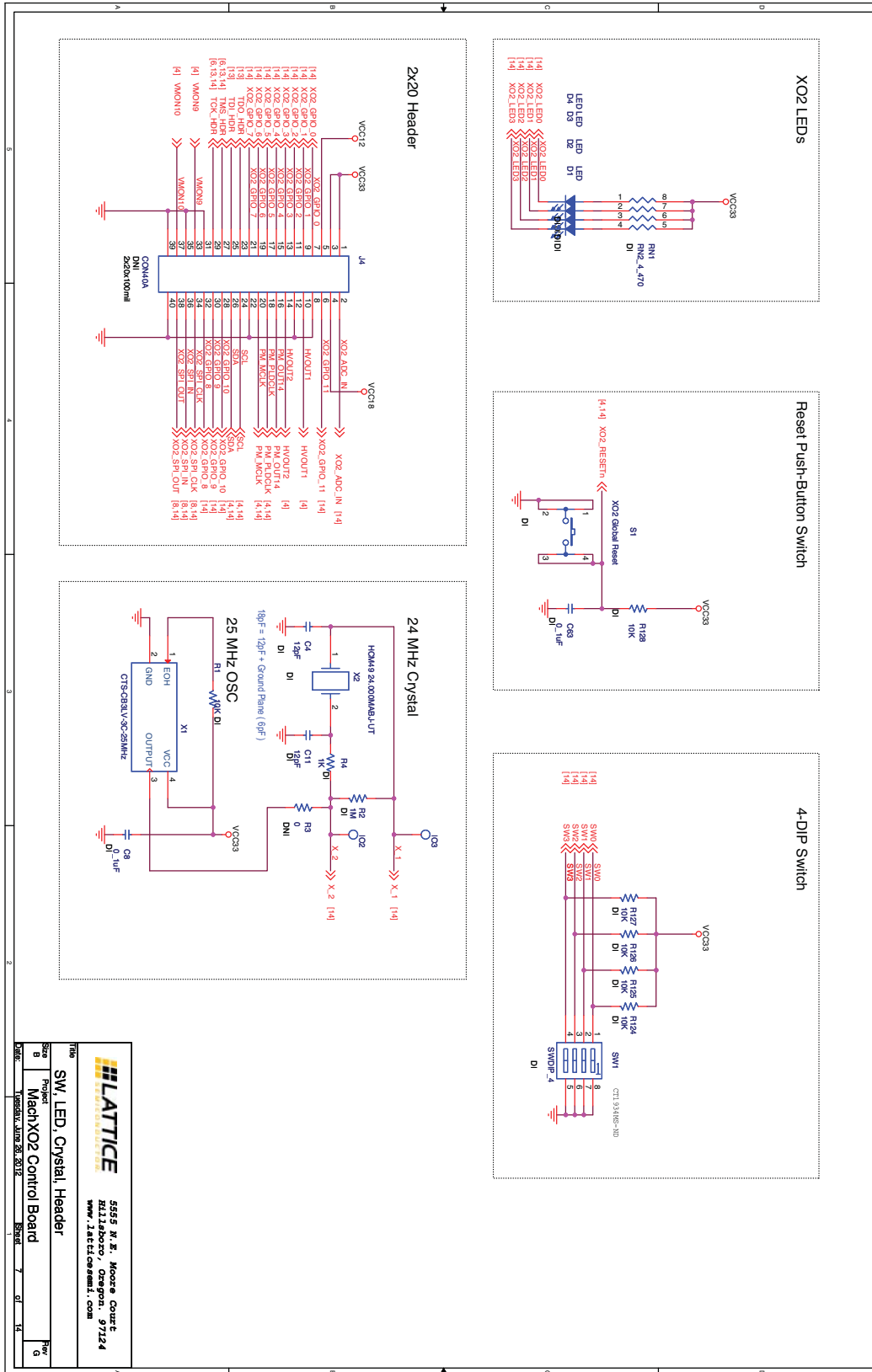

Figure 16. Video Input 1

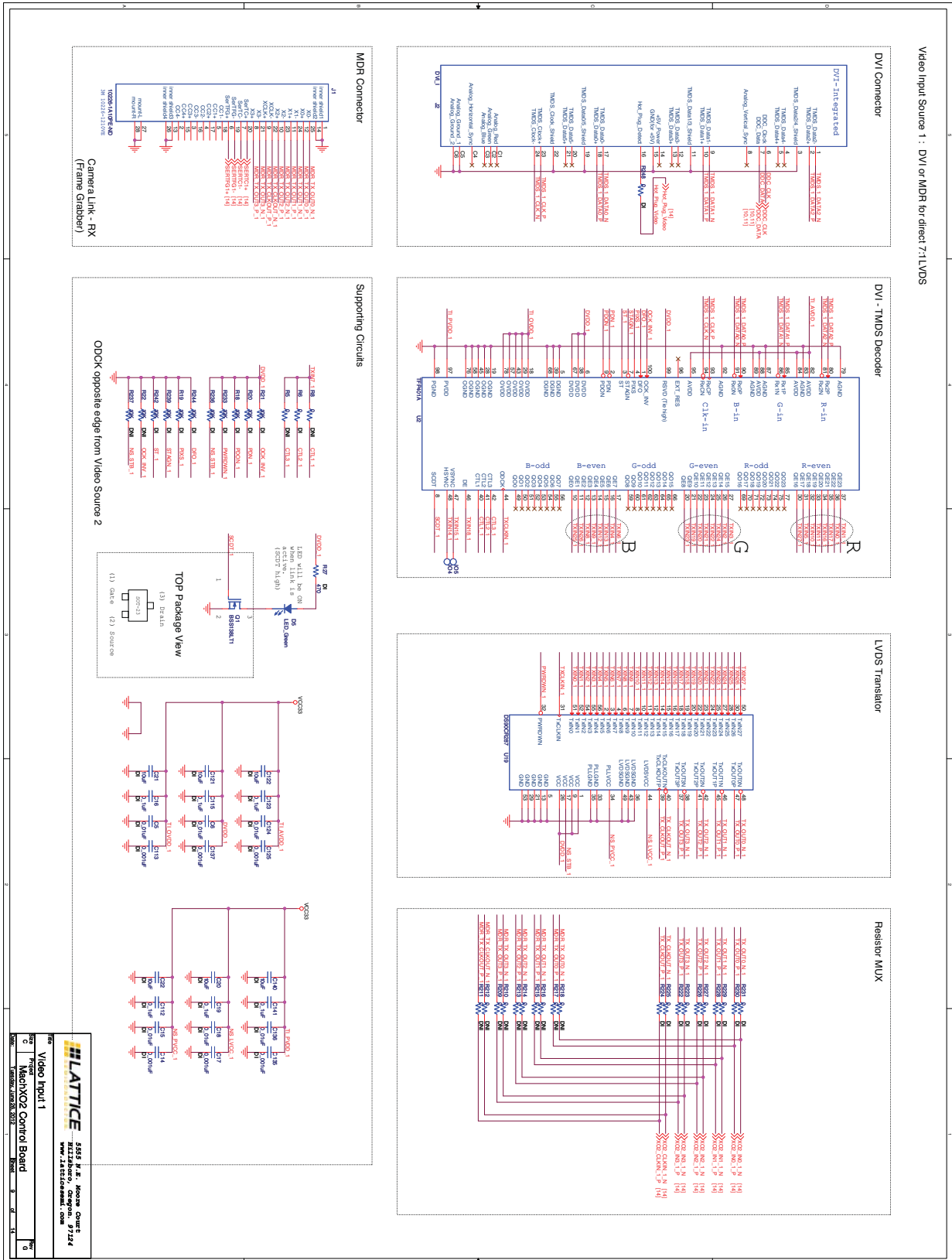

Figure 17. Video Input 2

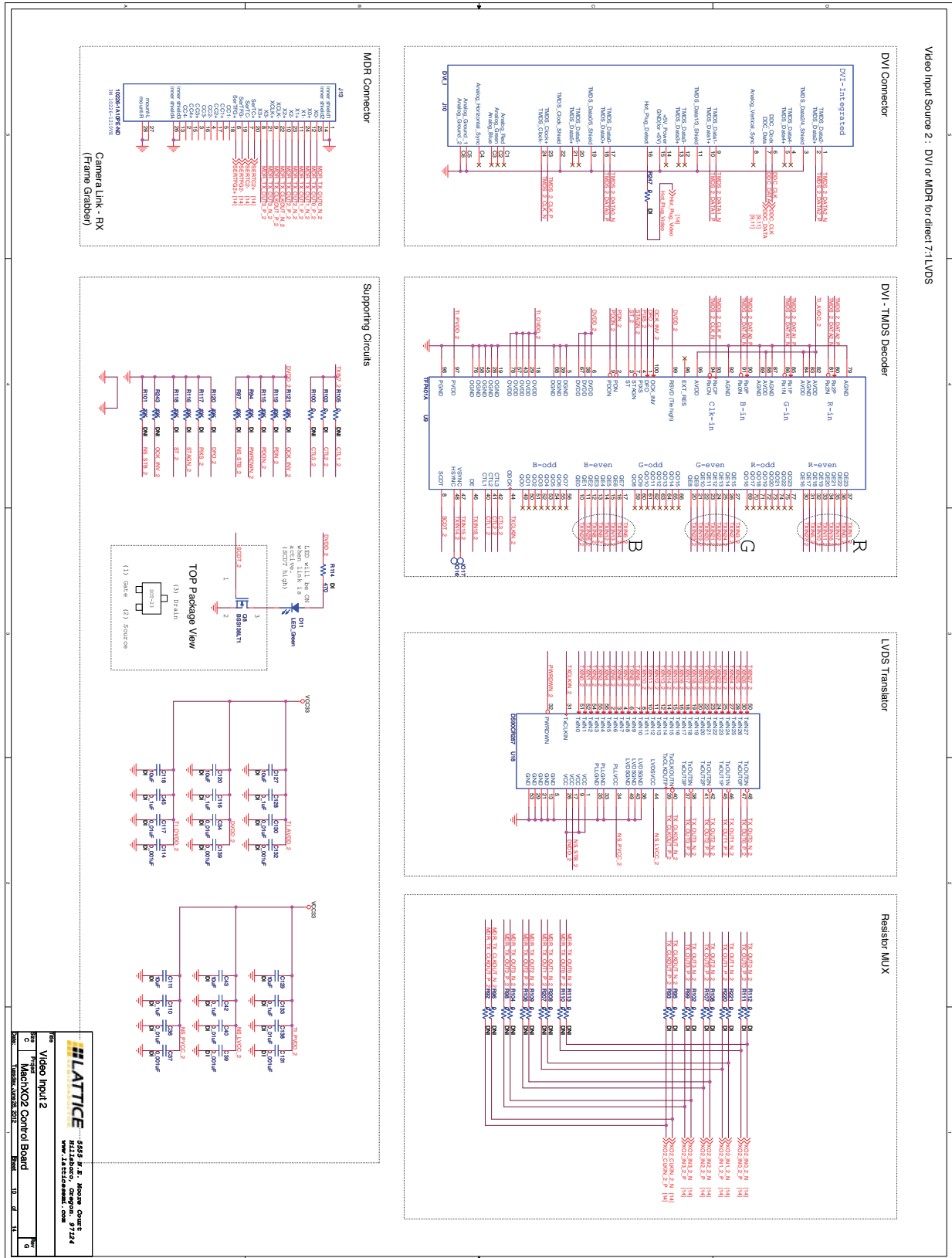

Figure 18. Video Output

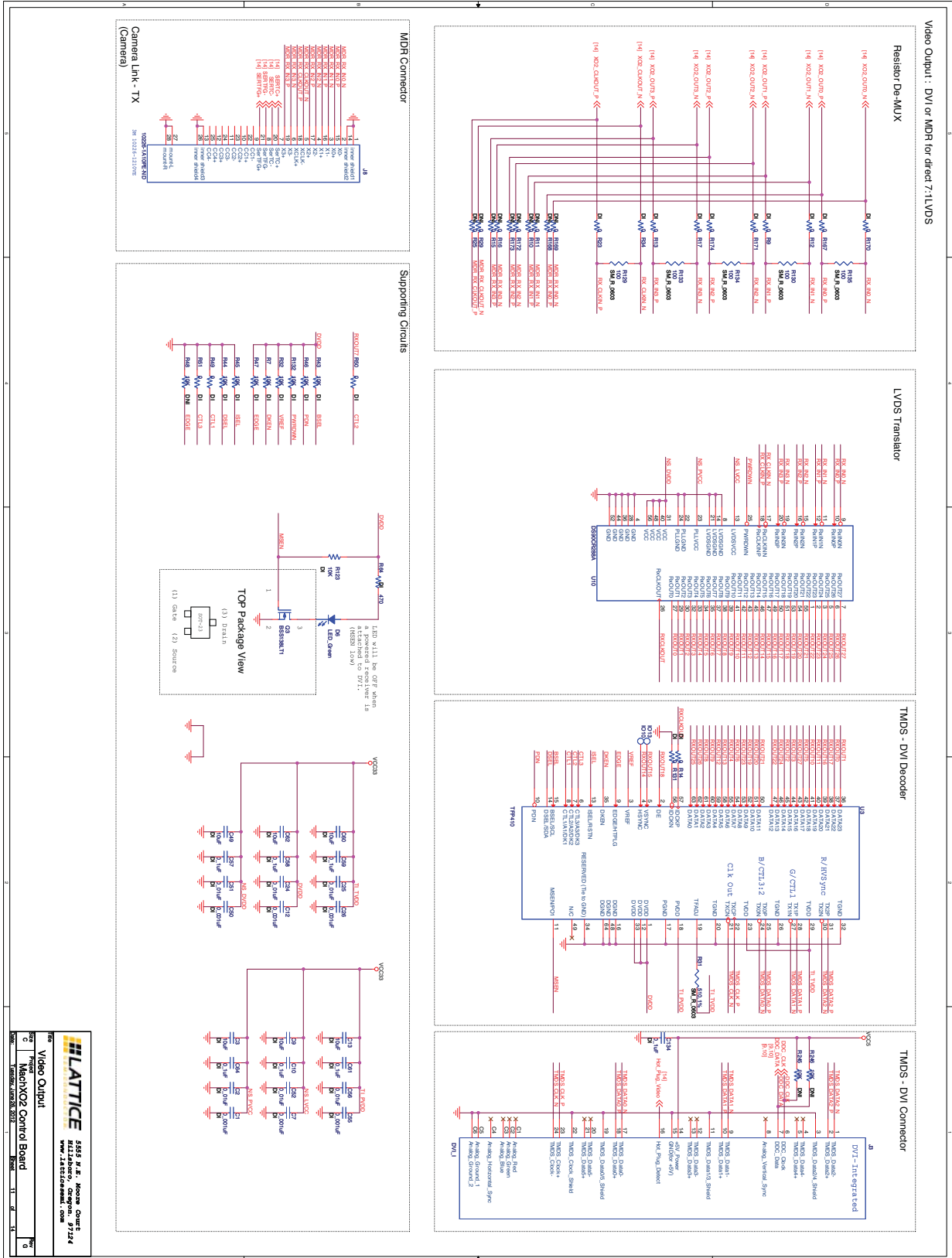

Figure 19. Audio In/Audio Out

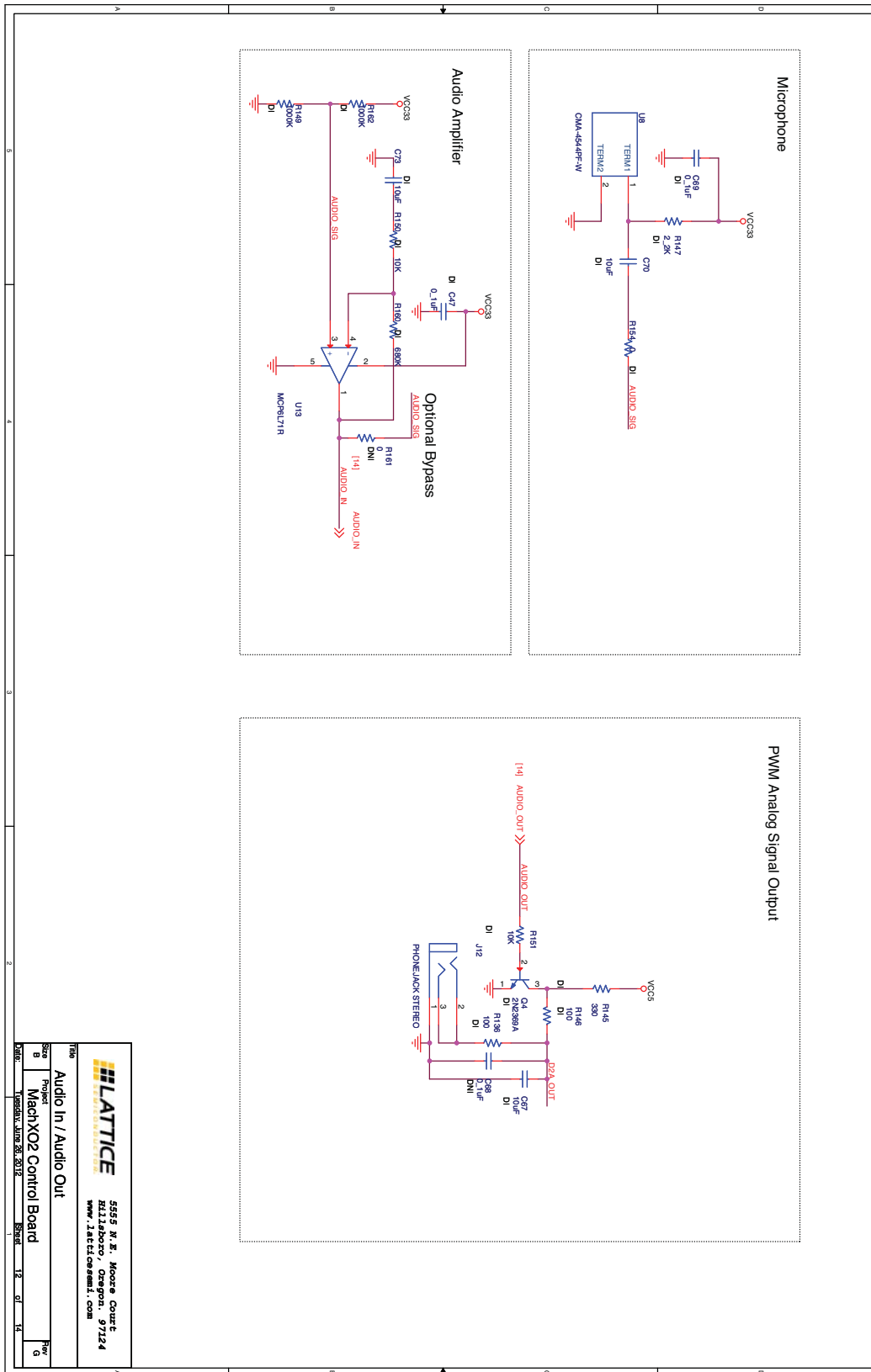

Figure 20. MachXO2 Supplies, JTAG

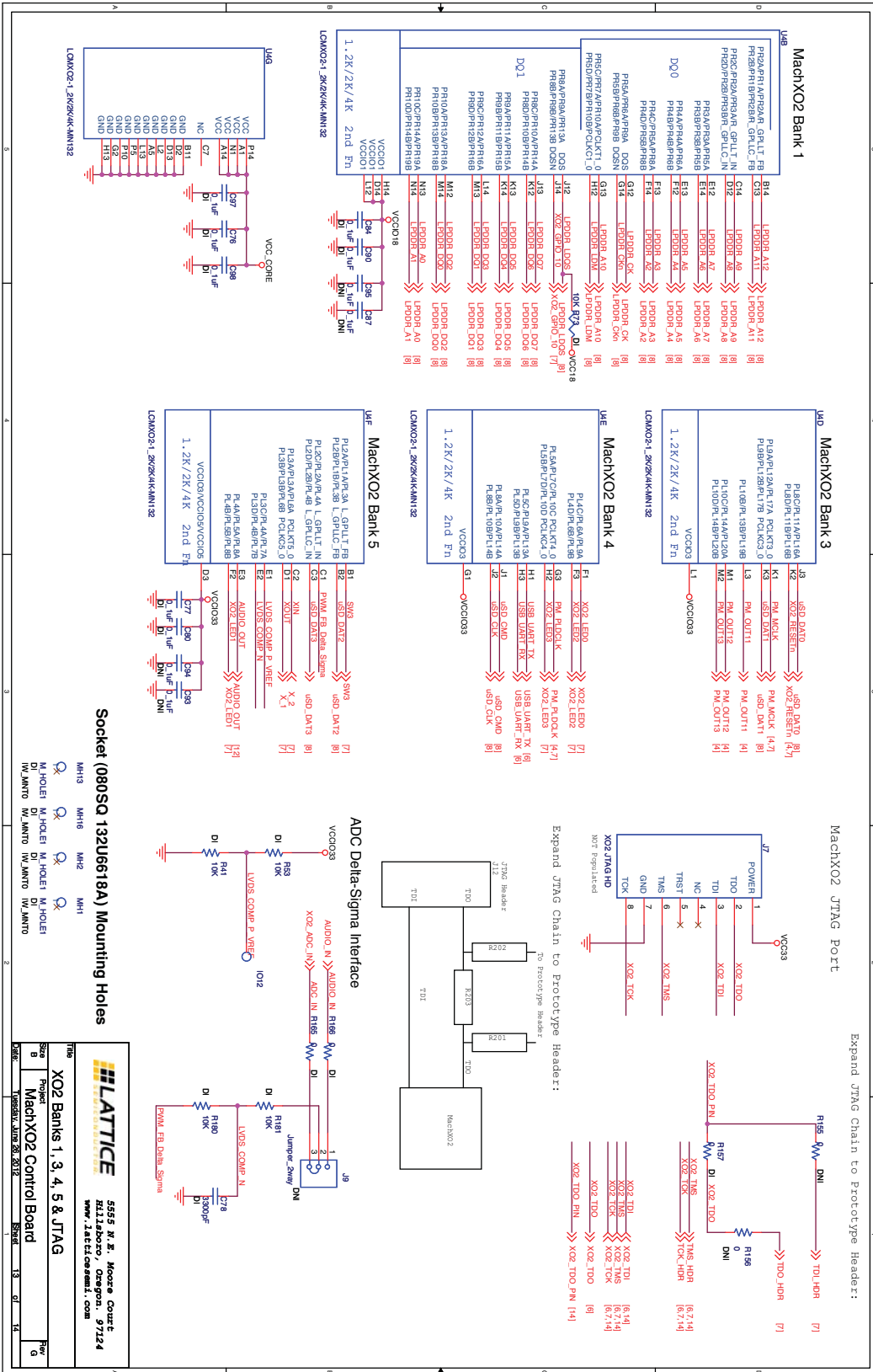
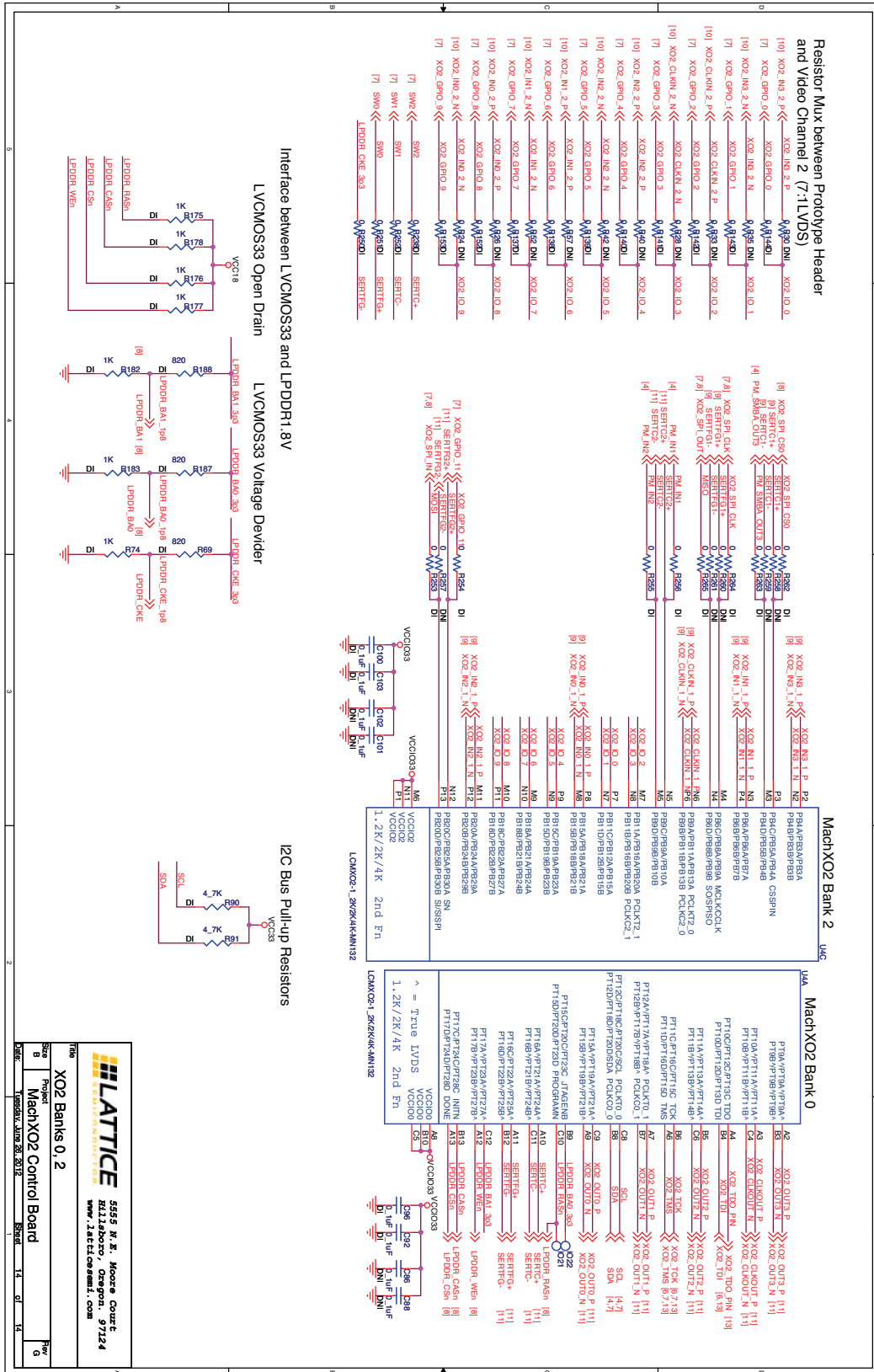

Figure 21. MachXO2 Top, Bottom



Appendix B. Bill of Materials

Table 1. Bill of Materials

Item	Quantity	Reference	Value	PCB Footprint	Manufacturer Part Number	Manufacturer	Description	Populate
1	19	C1, C7, C12, C14, C17, C26, C37, C39, C50, C55, C71, C113, C114, C125, C131, C132, C135, C137, C139	0_001uF	SM_C_0201				DI
2	23	C2, C5, C6, C15, C18, C24, C25, C32, C34, C36, C38, C40, C41, C51, C52, C56, C72, C91, C117, C124, C130, C136, C138	0_01uF	SM_C_0201				DI
3	18	C3, C9, C13, C20, C21, C22, C43, C49, C60, C62, C111, C118, C120, C121, C122, C127, C129, C140	10uF	SM_C_0603	C1608Y5V0J106Z	TDK		DI
4	2	C4, C11	12pF	SM_C_0603				DI
5	32	C8, C10, C16, C19, C42, C44, C45, C46, C47, C57, C58, C59, C61, C63, C64, C69, C74, C81, C89, C99, C105, C107, C109, C110, C112, C115, C116, C123, C128, C133, C134, C141	0_1uF	SM_C_0603				DI
6	2	C23, C29	18pF	cc0402	C0402C180K3GACTU	Kemet	CAP CER 18PF 25V C0G 0402	DI
7	10	C27, C30, C31, C48, C82, C85, C104, C119, C126, C145	0.1uF	cc0402	C0402C104K4RACTU	Kemet	Cap Cer 0.1uF 16V X7R 0402	DI
8	1	C28	10u	cc0603	ECJ-1VB0J106M	Panasonic	Cap Cer 10uF 6.3V 20% X5R 0603	DI
9	4	C33, C106, C142, C143	10uF	SM_C_0805	JMK212BJ106KD-T	TAIYO YUDEN		DI
10	2	C35, C83	1uF	SM_C_0805				DI
11	2	C53, C65	22uF	SM_C_0805	LMK212BJ226MG-T	TAIYO YUDEN		DI
12	4	C54, C66, C70, C73	10uF	SM_C_0805				DI
13	1	C67	10uF	SM_C_0603				DI
14	1	C68	0_1uF	SM_C_0603				DNI
15	13	C75, C76, C77, C79, C80, C84, C90, C92, C96, C97, C98, C100, C103	0_1uF	SM_C_0201				DI
16	1	C78	3300pF	SM_C_0603				DI
17	8	C86, C87, C88, C93, C94, C95, C101, C102	0_1uF	SM_C_0201				DNI
18	1	C108	0_01uF	SM_C_0201				DI
19	1	C144	4u7	cc0603	ECJ-1VB0J475K	Panasonic	Cap Cer 4.7uF 6.3V 10% X5R 0603	DI
20	8	D1, D2, D3, D4, D7, D8, D9, D10	LED	SM_D_0603	LTST-C190CKT	LITE ON		DI
21	2	D5, D6	LED_Green	SM_D_0603	LTST-C190KGKT	LITE ON		DI
22	1	D11	LED_Green	SM_D_0603	LTST-C190KGKT	LITE ON		DNI
23	1	D12	LED	SM_D_0603	LTST-C190CKT	LITE ON		DI
24	20	IO2, IO3, IO4, IO5, IO7, IO8, IO9, IO10, IO11, IO12, IO13, IO14, IO15, IO16, IO17, IO18, IO19, IO20, IO21, IO22	T POINT R	TP				DNI
25	2	J1, J8	10226-1A10PE-ND	10226-1A10PE-ND	10226-1A10PE	3M	CONN RECEPT 26POS R/A .050" SMD	DI
26	1	J13	10226-1A10PE-ND	10226-1A10PE-ND	10226-1A10PE	3M	CONN RECEPT 26POS R/A .050" SMD	DNI
27	2	J2, J3	DVI_I	DVI_I	74320-1004	Molex		DI
28	1	J4	CON40A	2x20x100mil	TSW-120-07-T-D	Samtec		DI
29	1	J5	USB_MINI_B	TYPE_B	UX60-MB-5ST	Hirose		DI
30	1	J6	Jumper_2way	JP_2WY	TSW-103-07-G-S	Samtec Inc.		DI
31	1	J7	XO2_JTAG HD	XO2_JTAG_HD				DNI
32	1	J9	Jumper_2way	JP_2WY	TSW-103-07-G-S	Samtec Inc.		DNI
33	1	J10	DVI_I	DVI_I	74320-1004	Molex		DNI
34	1	J11	PWR_JACK	PWR_CON	RAPC712	Switchcraft		DI

Table 1. Bill of Materials (Continued)

Item	Quantity	Reference	Value	PCB Footprint	Manufacturer Part Number	Manufacturer	Description	Populate
35	1	J12	PHONEJACK STEREO	SM	MJ1-3510-SMT	CUI		DI
36	1	L3	600ohm 500mA	FB0603	BLM18AG601SN1D	Murata	Ferrite Bead 600 Ohm @ 100 MHz 500 mA 0603	DI
37	4	MH1, MH2, MH13, MH16	M_HOLE1	IW_MNT0	SJ-5003 (BLACK)		BUMPON HEMI-SPHERE .44X.20 BLACK	DI
38	4	Q1, Q3, Q6, Q8	BSS138LT1	SOT_23	BSS138LT3G	ON Semi		DI
39	2	Q2, Q5	2N7002E	SM_SOT23	2N7002ET1G	ON_Semi		DI
40	1	Q4	2N2369A	2N2369A_SOT23	MMBT2369A	Fairchild		DI
41	1	Q7	ZDT758	SM_8_DUAL_PNP	ZDT758	Diodes/Zetex		DI
42	2	RN1, RN4	RN2_4_470	RN2_4_470_0603	TC164-JR-07470RL	Yageo		DI
43	1	RN2	RN1_8_10K	RN1_8_10K_0603	MNR18E0APJ103	Rohm Semi		DI
44	1	RN3	RN1_8_10K	RN1_8_10K_0603	MNR18E0APJ103	Rohm Semi		DI
45	45	R1, R7, R18, R19, R20, R21, R32, R41, R43, R44, R45, R46, R47, R53, R73, R81, R94, R97, R115, R116, R117, R118, R119, R120, R121, R123, R124, R125, R126, R127, R128, R132, R151, R158, R159, R163, R164, R180, R181, R200, R233, R236, R239, R242, R244	10K	SM_R_0402				DI
46	1	R2	1M	SM_R_0603				DI
47	53	R3, R5, R8, R10, R11, R15, R16, R24, R25, R26, R28, R29, R30, R33, R35, R40, R42, R52, R57, R92, R96, R98, R100, R104, R105, R106, R109, R110, R113, R155, R156, R161, R168, R169, R172, R173, R207, R208, R209, R210, R211, R212, R213, R214, R215, R216, R217, R218, R257, R258, R259, R260, R261	0	SM_R_0402				DNI
48	5	R4, R67, R195, R196, R232	1K	SM_R_0603				DI
49	80	R6, R9, R12, R13, R14, R17, R23, R34, R36, R37, R38, R39, R49, R50, R51, R61, R62, R70, R71, R75, R76, R78, R82, R83, R87, R93, R95, R99, R102, R103, R107, R108, R111, R112, R131, R137, R138, R139, R140, R141, R142, R143, R144, R152, R153, R154, R157, R165, R166, R167, R170, R171, R174, R186, R220, R221, R222, R223, R224, R225, R226, R227, R228, R229, R230, R231, R238, R247, R248, R250, R251, R252, R253, R254, R255, R256, R262, R263, R264, R265	0	SM_R_0402				DI
50	7	R22, R48, R101, R237, R243, R245, R246	10K	SM_R_0402				DNI
51	4	R27, R64, R114, R122	470	SM_R_0603	ERJ-3EKF4700V	Panasonic ECG		DI
52	1	R31	510, 1%	SM_R_0603				DI
53	9	R54, R55, R65, R66, R84, R85, R88, R89, R205	4_7K	SM_R_0603				DI
54	1	R56	2k2	cr0402	TNPW04022K20BEED	Vishay/Dale	RES 2.20K OHM 1/16W 0.1% 0402	DI
55	1	R58	0	SM_R_0805				DNI
56	1	R59	1	SM_R_0805				DI
57	2	R60, R219	220	SM_R_0603				DI
58	2	R63, R68	0	SM_R_0603				DI
59	3	R69, R187, R188	820	SM_R_0402				DI
60	8	R74, R175, R176, R177, R178, R182, R183, R234	1K	SM_R_0402				DI
61	1	R79	100K	SM_R_0603				DI
62	2	R80, R86	68	SM_R_0402				DI
63	2	R90, R91	4_7K	SM_R_0402				DI

Table 1. Bill of Materials (Continued)

Item	Quantity	Reference	Value	PCB Footprint	Manufacturer Part Number	Manufacturer	Description	Populate
64	13	R129, R130, R133, R134, R135, R136, R146, R184, R185, R191, R194, R201, R206	100	SM_R_0603				DI
65	1	R145	330	SM_R_0603				DI
66	1	R147	2_2K	SM_R_0603				DI
67	2	R148, R235	2	SM_R_0805				DI
68	2	R149, R162	1000K	SM_R_0603				DI
69	1	R150	10K	SM_R_0603				DI
70	1	R160	680K	SM_R_0603				DI
71	2	R179, R198	200	SM_R_0603				DI
72	4	R189, R190, R192, R193	3_92K	SM_R_0603				DI
73	2	R197, R204	2K	SM_R_0603				DI
74	1	R199	12k	cr0402	RC0402FR-0712KL	Yageo	Res 1/16W 12.0K 1% 0402	DI
75	4	R202, R203, R241, R249	10k	cr0402	RC0402FR-0710KL	Yageo	Res 1/16W 10.0K 1% 0402	DI
76	1	R240	2.2K	SM_R_0402	RC0402FR-072K2L	Yageo	Res 1/16W 2.2K 1% 0402	DI
77	1	SW1	SWDIP_4	SMD_8check	3-5435640-5	Tyco	SWITCH DIP 4POS SEALED GOLD	DI
78	1	SW2	SW DIP_2	SP_75	195-2MST	CTS	SWITCH SIDE ACTUATED 2 SEC	DI
79	1	S1	XO2 Global Reset	SMT_SW	EVQ-Q2K03W	Panasonic	SWITCH LT 6MM 130GF H=3.1MM SMD	DI
80	1	U1	microSD Socket	SM_SD	460DE08C3	MULTICOMP		DI
81	1	U2	TFP401A	HTQFP_100	TFP401APZPG4	TI		DI
82	1	U3	TFP410	HTQFP_64	TFP410PAP	TI		DI
83	1	U4	LCMXO2-4000HC -6MG132	CSBGA132	LCMXO2-4000HC-6MG132	Lattice Semi		DI
84	1	U5	STG3693QTR	QFN	STG3693QTR	STMicroelectronics		DI
85	1	U6	MT46H16M16LFBF	SM/60VFPGA	MT46H16M16LFBF	Micron		DI
86	1	U7	ispPAC-POWR1014A	TQFP_48	ispPAC-POWR1014A-01TN48I	Lattice		DI
87	1	U8	CMA-4544PF-W	2 Solder Pins (TH)	CMA-4544PF-W	CUI Inc		DI
88	1	U9	TFP401A	HTQFP_100	TFP401APZPG4	TI		DNI
89	1	U10	DS90CR288A	TSSOP_56	DS90CR288AMTD/NOPB	National Semi		DI
90	1	U11	NCP1117ST33	SOT_223	NCP1117ST33T3G	ONSem		DI
91	1	U12	NCP1117ST18	SOT_223	NCP1117ST18T3G	ONSem		DI
92	1	U13	MCP6L71R	SOT_23_5_MC	MCP6L71RT-E/OT	Microchip		DI
93	1	U14	AT25DF041A-SH-B	SOIC_8	AT25DF041A-SH-B	Atmel		DI
94	1	U15	AT25DF041A-MH-B	UDFN	AT25DF041A-MH-B	Atmel		DNI
95	1	U16	AD8604ARZ	14_SOIC	AD8604ARZ	Analog Devices		DI
96	1	U17	Value	MRA08A_M	LP3879MR-1.2	National		DNI
97	1	U18	DS90CR287	TSSOP_56	DS90CR287MTD/NOPB	TI		DNI
98	1	U19	DS90CR287	TSSOP_56	DS90CR287MTD/NOPB	TI		DI
99	1	U20	FT2232HL	tqfp64_0p5_12p2x12p2_h1p6	FT2232HL	FTDI		DI
100	1	U21	93LC56-SO8	so8_50_244	93LC56T-I/SN	Microchip	IC 93LC56 EEPROM	DI
101	1	X1	CTS-CB3LV-3C-25MHz	SMD 7.00mm x 5.00mm	CB3LV-3C-25M0000	CTS	OSC 25.000 MHZ 3.3V SMD	DNI
102	1	X2	HCM49 24.000MABJ-UT	SMD	HCM49 24.000MABJ-UT	Citizen Finetech	CRYSTAL 24.000 MHZ 18PF SMD	DI
103	1	X3	12 MHZ	crystal_4p_3p2x2p5	7M-12.000MAAJ-T	TXC	CRYSTAL 12.000 MHZ 18PF SMD	DI

X-ON Electronics

Largest Supplier of Electrical and Electronic Components

Click to view similar products for [Programmable Logic IC Development Tools](#) category:

Click to view products by [Lattice](#) manufacturer:

Other Similar products are found below :

[HLDC-DDR3-A](#) [DK-DEV-5SGXEA7N](#) [EPXA4F672C2](#) [EPXA4F672C3](#) [EPXA4F672C1](#) [P0435](#) [K0161](#) [LCMXO256C-S-EVN](#)
[12GSDIFMCCD](#) [SFP+X4FMCCD](#) [88980182](#) [P0582](#) [HW-PWAC-2600317](#) [DEV-17514](#) [LCMXO3D-9400HC-B-EVN](#) [P0671](#) [P0467](#)
[LCMXO2-1200ZE-P1-EVN](#) [LCMXO2-4000HE-DSIB-EVN](#) [DK-DEV-4SGX530N](#) [LCMXO3L-SMA-EVN](#) [P006-006-2](#) [EK-U1-VCU108-G](#)
[A2F500-DEV-KIT-2](#) [LCMXO3LF-9400C-ASC-B-EVN](#) [471-014](#) [EVAL-TPG-ZYNQ3](#) [SL001](#) [80-001005](#) [EK-10CL025U256](#) [P0496](#) [P0493](#)
[DK-SOC-10AS066S-A](#) [DK-DEV-10CX220-A](#) [cs-beaglewire-01](#) [80-001002](#) [iCE40UP5K-MDP-EVN](#) [RXCA10S066PF34-IDK00A](#)
[SLG4DVKADV](#) [ALTHYDRAC5GX](#) [ALTNITROC5GX](#) [ALTBERYLLC5GX](#) [471-015](#) [LFE3-17EA-USB3-EVN](#) [1553](#) [4332](#) [Hinj](#) [HinjKit](#)
[SNOMAKRRKIT](#) [SnoMakrR10](#)