



ECP5-5G™ Versa Development Board User Guide

EB103 Version 1.2, January 2016

Introduction

The ECP5-5G™ Versa Development Board allows designers to investigate and experiment with the features of the ECP5-5G Field-Programmable Gate Array. The features of the ECP5-5G Versa Development Board can assist engineers with rapid prototyping and testing of their specific designs. The ECP5-5G Versa Development Board is part of the ECP5-5G Versa Development Kit. The guide is intended to be referenced in conjunction with demo user guides to demonstrate the ECP5-5G FPGA.

Figure 1. ECP5-5G Versa Development Board, Top Side

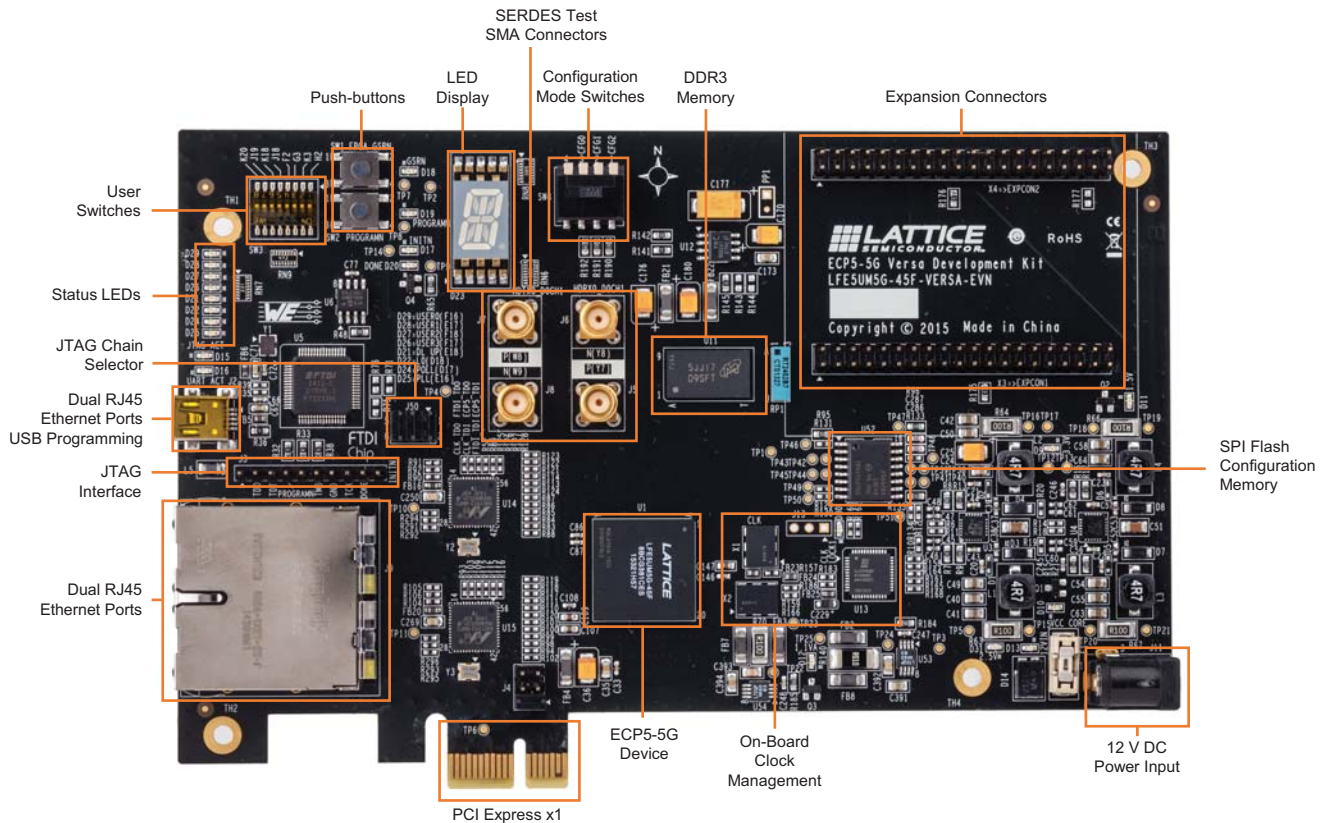

Features

- Half-length PCI Express form-factor
 - Allows demonstration of PCI Express x1 interconnection
- Electrical testing of one full-duplex SERDES channel via SMA connections
- USB-B connection for UART and device programming
- Two RJ45 interfaces to 10/100/1000 Ethernet to RGMII
- On-board Boot Flash
 - 128M Serial SPI Flash
- DDR3-1866 memory components (64Mb/x16)
- Expansion mezzanine interconnection for prototyping
- 14-segment alpha-numeric display
- Switches, LEDs and displays for demo purposes
- Diamond® programming support
- On-board reference clock sources

The contents of this user guide include top-level functional descriptions of the various portions of the evaluation board, descriptions of the on-board connectors, diodes and switches and a complete set of schematics.

Caution: The ECP5-5G Versa Development Board contains ESD-sensitive components. ESD safe practices should be followed while handling and using the evaluation board.

ECP5-5G Device

This board features an ECP5-5G FPGA with a 1.2 V core supply. It can accommodate all pin-compatible ECP5-5G devices in the 381 ball caBGA package. A complete description of this device can be found in DS1057, [ECP5-5G Family Data Sheet](#).

*Note: The connections referenced in this document refer to the **LFE5UM5G-45F-8BG381C** device.*

Applying Power to the Board

The ECP5-5G Versa Development Board is ready to power on. The board can be supplied with power from a PCI Express host system or standalone with an external wall power module.

The 12 V DC input power source is fused with a surface mounted fuse, as noted in Table 1.

Table 1. Board Power Supply Fuses (See Appendix A, Sheet 2, Figure 14- Voltage Regulators)

Fuse Designator	Description
F1	12 V Input Supply Fuse

The board may be plugged into a host PC. Only plug the board into a PCI Express slot when the system is powered off. Once inserted, the PC can be safely powered on.

Using the evaluation board outside of a PC chassis supply requires the factory-supplied wall supply module. Use of other supplies is not suggested.

Figure 2. Power Distribution Scheme (See Appendix A, Sheet 2, Figure 14- Voltage Regulators)

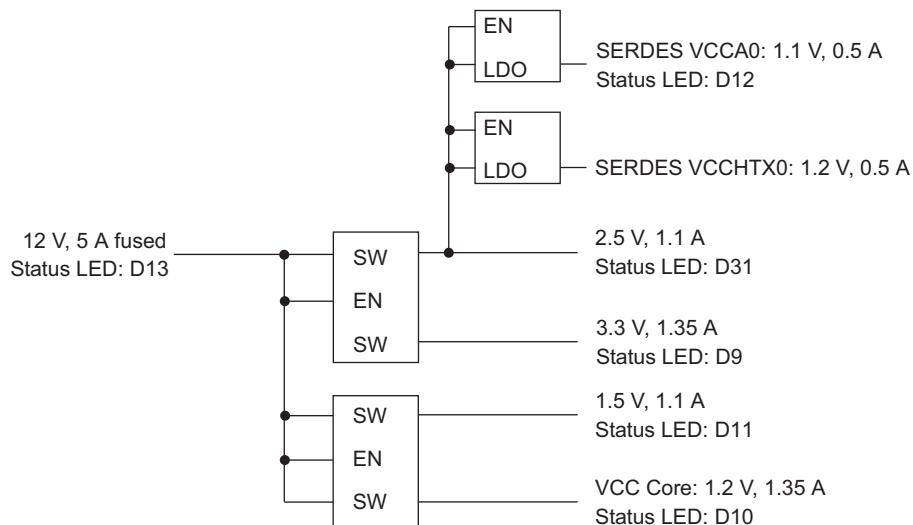

Programming/FPGA Configuration

The ECP5-5G Versa Development Board has a built-in download controller for programming the ECP5-5G FPGA. The built-in module consists of a USB Type-B connector and a USB UART device. To use the built-in download cable, simply connect a standard USB cable (a USB-B to USB-A cable is included with the ECP5-5G Versa Development Kit) from J2 to your PC (with Diamond programming software installed). The USB hub on the PC will detect the addition of the USB function, making the built-in cable available for use with the Diamond programming software. The USB cable is connected in parallel to J3.

Alternate Programmer Download Interface

J3 is a 10 pin JTAG connector that is provided for use with an external Lattice download cable (available separately). A USB download cable can be attached to the board using J3 to interface with the FPGA (U1).

Note: Resistors R38, R33, R32 and R36 need to be removed for programming with J3.

The same interface can be used to access the ispClock 5406D clock device (U13) by reconfiguring the jumpers on J50 (See Appendix A, Sheet 3, Figure 15 - Programming). U13 is factory-programmed for use with the reference designs and should only be altered for customized designs.

Table 2. JTAG Connector Pinout (J3) (See Appendix A, Sheet 3, Figure 15 - Programming)

Pin	Function
1	PWR
2	TDO
3	TDI
4	PROGRAMn
5	N/C
6	TMS
7	GND
8	TCK
9	DONE
10	INITn

Diamond Programmer Requirements

Note: This board includes the built-in download module and only requires the USB cable included with the board. After initial board setup, use the following procedure to program the board. Instructions assume that Diamond Programmer software has been installed on a local PC.

Requirements:

- PC with Diamond Programmer 3.5.1 (or later) programming software, installed with appropriate drivers (USB driver for USB cable).

Note: An option to install these drivers is included as part of the Diamond Programmer setup.

Setting the Configuration Mode

The ECP5-5G device on the ECP5-5G Versa Development Board supports a variety of configuration modes, including 1149.1 JTAG and Master SPI. Refer to TN1260, [ECP5 and ECP5-5G sysCONFIG Usage Guide](#). On the PCB, use the CFG Setting Dip Switch SW4 described in Table 3.

Note: SW4.4 is unused.

Figure 3. SW4

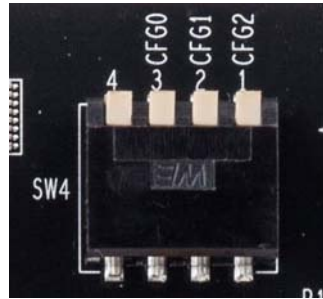

Table 3. CFG[2:0] Selection

Configuration Mode	CFG[2:0]	SW4.3	SW4.2	SW4.1
1149.1 JTAG only	000	Down	Down	Down
Slave SPI	001	Down	Down	Up
Master SPI	010	Down	Up	Down
SCM (Slave_Serial)	101	Up	Down	Up
SCM (Slave_Parallel)	111	Up	Up	Up

Board Programming

The ECP5-5G programmable devices can be programmed using a computer running Lattice Diamond or Lattice Diamond Programmer software connected to the Development board via a standard mini-USB cable. Refer to the ECP5-5G Versa Development Kit Quick Start Guide (QS039) for more details. Once the programming software is installed and the USB cable is connected to the board, the programmable devices can be programmed.

Figure 4. J50

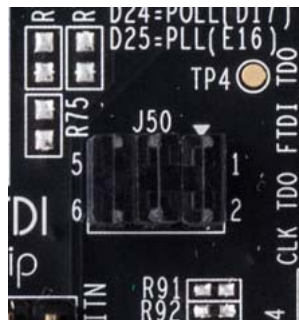

The ECP5-5G FPGA (U1) and the ispClock5406D (U13) device can be programmed individually or together. JTAG Chain Selector Header J50 is used to select which device(s) will be connected to the JTAG programming bus. The ECP5-5G FPGA SRAM can be programmed directly, or the subtended configuration serial SPI flash (U52) programmed, via the same J50 setting. See Table 4 and the diagrams below.

Table 4. JTAG Chain Selector

J50 Shunts	JTAG Chain
1-2, 3-4, 5-6	ECP5-5G + ispClock
1-2, 3-5	ECP5-5G only
2-4, 5-6	ispClock only

Figure 5. J50 Settings

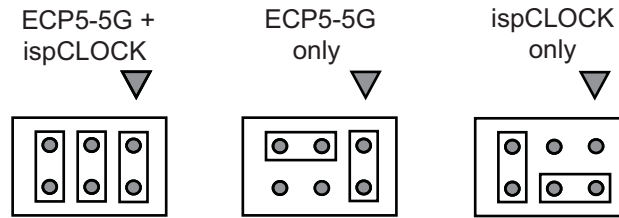

Figure 6. ECP5-5G Status LEDs and Push-button Controls



The LEDs indicate the configuration status of the ECP5-5G FPGA.

- **D17 (red)** illuminated indicates that programming was aborted or reinitialized, driving the INITN output low.
- **D20 (green)** illuminated indicates the successful completion of configuration by releasing the open collector DONE output pin.
- **D19 (red)** illuminated indicates that PROGRAMN is low.
- **D18 (red)** illuminated indicates that GSRN is low.

PROGRAMN and GSRN

These push-button switches assert/de-assert the logic levels on PROGRAMN (SW2) and GSRN (SW1). Depressing the button drives a logic level “0” to the device.

Programming Serial SPI Flash Memory

A serial SPI (16-pin TSSOP, 128M) Flash memory device (U52) is on-board for non-volatile configuration memory storage. A Micron N25Q128A device is populated on-board.

The Serial SPI Flash memory device can be configured easily via the ECP5-5G JTAG port. This mode enables the FPGA to be programmed at power-up or assertion of PROGRAMN with a bitstream stored in the memory device.

1. Connect the ECP5-5G Versa Development Board.
2. Set J50 jumper to *ECP5-5G only* programming (See the [Board Programming](#) section.)
3. Scan the board or select the **LFE5UM5G-45F** device in the ECP5UM5G device family.
4. From the Edit pull down menu select **Device Properties**. Set the Access mode to **SPI Flash Background Programming** and Operation to **SPI Flash Erase, Program, Verify**.

Figure 7. Diamond Programmer Main Screen

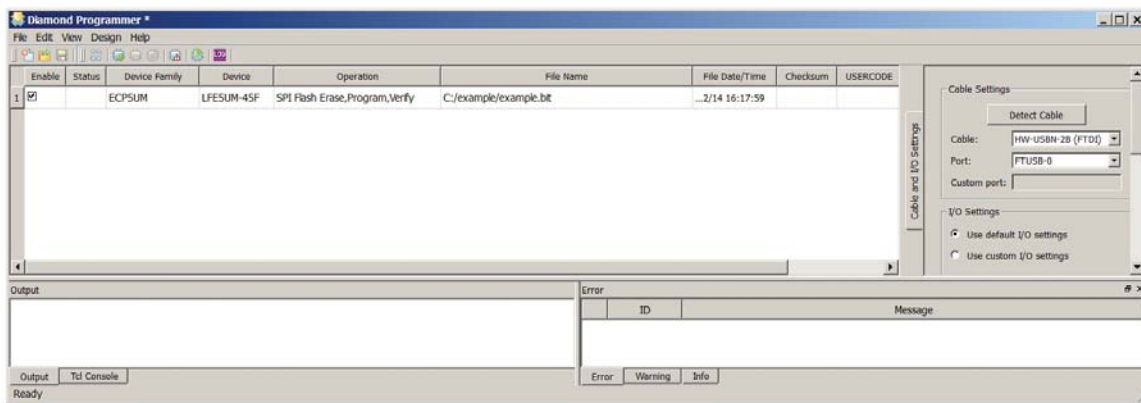

5. Under the SPI Flash Options, select Family to **SPI Serial Flash**, Vendor to **Micron**, Device to **SPI-N25Q128A**, Package to **16-pin SO16**.

Figure 8. Device Properties Dialog Box

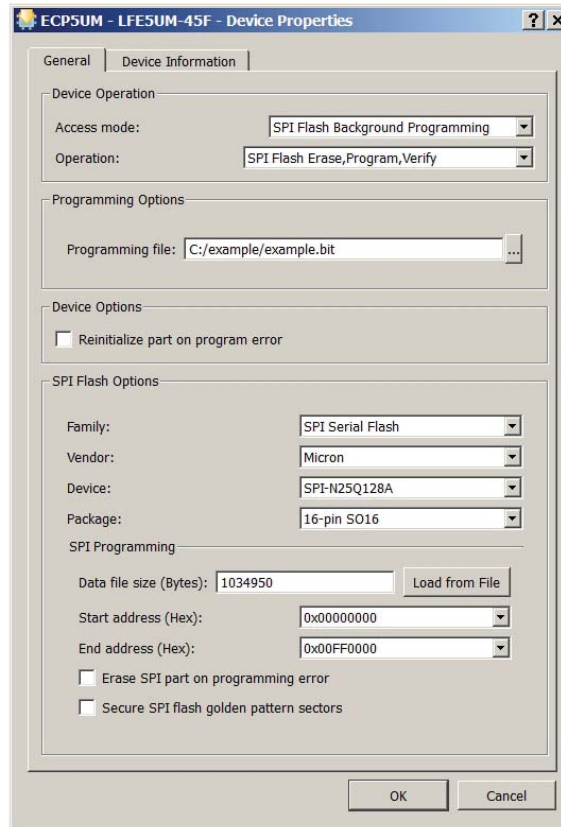

6. Click **OK** in the Device Properties dialog box. You will return to the main configuration screen.
7. From the main programming window, select **Program** from the top toolbar. This begins the SPI Serial Flash programming. Note that the SPI Flash Background Programming operation is only possible when the ECP5-5G device is either erased or the active design has the MASTER_SPI_PORT mode enabled. For more details see TN1260, [ECP5 and ECP5-5G sysCONFIG Usage Guide](#).

On-Board Clock Capabilities

(See Appendix A, Sheet 9, Figure 21 - Reference Clock Generator)

The ECP5-5G Versa Development Board allows for several clock source options. Some of these options are controlled via the ispClock5406D programmable clock manager device. The ispClock5406D enables the reference clock from the PCI Express interface to provide a reference clock to the SERDES. This is true only when the board is in a PCI Express host socket. When the board is not in a PCI Express host socket, the clock will be supplied by a 156.25 MHz clock on-board oscillator. Both clock inputs can be fanned out to the dedicated SERDES reference inputs, FPGA inputs, and to the expansion connectors. The factory default programming provides a variety of clocks to the SERDES and FPGA inputs to support Factory defined 5G applications. The ispClock chip may be programmed with user defined configurations to support a wide range of user applications.

Figure 9. Clock Controller Scheme

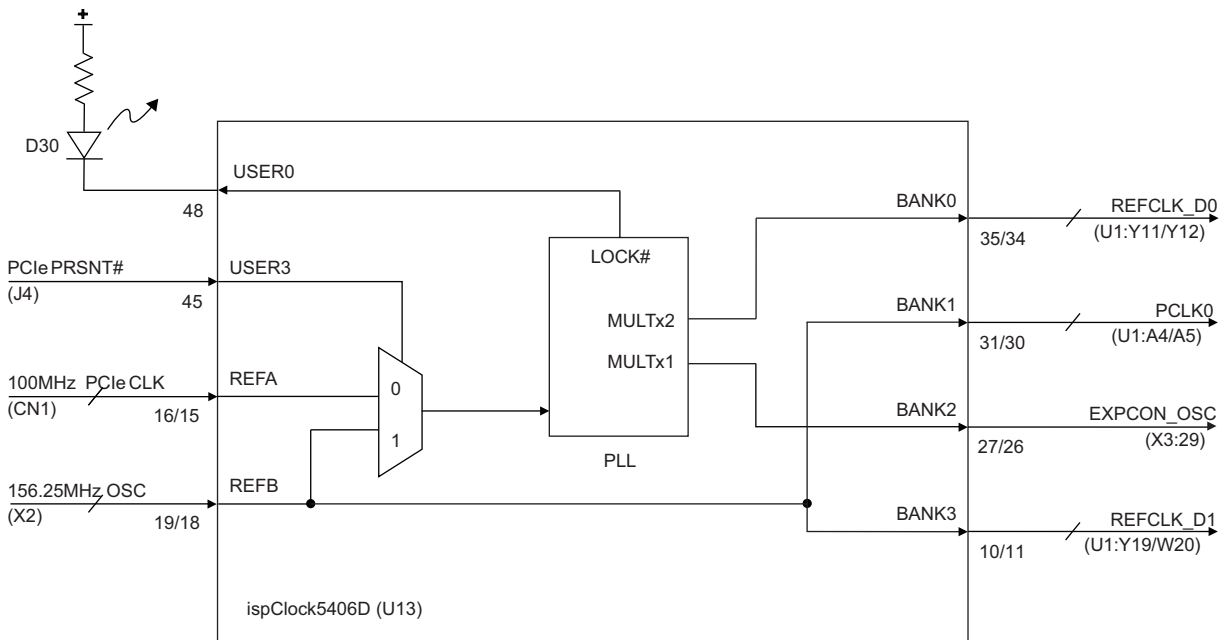

General Purpose Clock Source

An on-board 100 MHz LVDS oscillator is provided for general purpose use. This clock source is connected to differential inputs P3 and P4 and must be used as LVDS inputs to the FPGA. This pin pair also provides optimal interface to the FPGA PLL for customized use.

The PCI Express add-in card specification requires add-in boards to include capabilities to tell the host of its presence. The ECP5-5G Versa Development Board allows this optional connection via a board jumper. Using the board with a PCI Express host requires the setting shown in Figure 10 below.

Figure 10. PCI Express PRSNT Control Connection

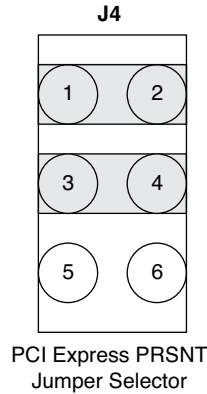

SERDES

The ECP5-5G Dual Channel Unit (DCU) SERDES FPGA is utilized on the board for several purposes. DCU0, Channel 0 is provisioned to provide a single, full-duplex PCI Express channel. The high-speed signals are connected to the PCI Express edge connection. DCU0, Channel 1 is connected to the SMA connectors for external electrical demonstrations.

Table 5. PCI Express Channel Interconnections

Signal Name	SERDES Port	FPGA Ball Number
PETp0	HDRXP0_D0CH0	Y5
PETn0	HDRXN0_D0CH0	Y6
PERp0	HDTXP0_D0CH0	W4
PERn0	HDTXN0_D0CH0	W5

Table 6. SMA Test Interconnections

Connector	SERDES Port	FPGA Ball Number
J5	HDRXP0_D0CH1	Y7
J6	HDRXN0_D0CH1	Y8
J7	HDTXP0_D0CH1	W8
J8	HDTXN0_D0CH1	W9

FPGA Test Pins

(See Appendix A, Sheet 8, Figure 20 - LEDs and Switches)

General Purpose DIP Switches

General purpose FPGA pins are available for user applications. FPGA pins are connected to switch SW3, a SPST slide-actuated DIP switch. The switches are connected to logic level 0 when moved to the ON position. Switch position 1 is indicated with an arrow. *Inputs 1-4 are within a 1.5 V bank and inputs 5-8 are within a 2.5 V bank.* The user must program inputs 1-4 to be the LVC MOS15 type and inputs 5-8 to be the LVC MOS25 type in the design. Figure 12 shows the switches. Note the silk marking associated with SW3-7 is incorrect in revision B, SW3-7 is mapped to K19, per Table 7.

Figure 11. ECP5-5G Versa Development Board LEDs and Switches

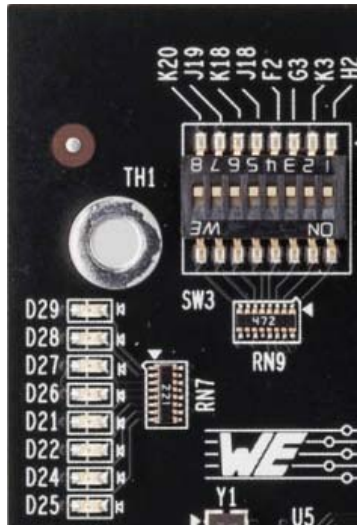

The designated pins are connected according to Table 7.

Table 7. FPGA Ball to DIP Switch Position

FPGA Ball Number	SW3 DIP Switch Position
H2	1
K3	2
G3	3
F2	4
J18	5
K18	6
K19	7
K20	8

General Purpose LEDs

(See Appendix A, Sheet 8, Figure 20 - LEDs and Switches)

The LEDs provided on the ECP5-5G Versa Development Board are connected to general purpose FPGA I/Os. These LEDs provide status for user designs and must be included in the design. The LEDs illuminate when the FPGA output is driven LOW. Table 8 shows the LED and associated FPGA pins. These pins are within an I/O bank connected to 2.5 V and the user should program these to be LVCMOS25 type outputs in the design.

Table 8. LED Definitions

LED Designator	FPGA Ball Number	LED Color
D25	E16	Yellow
D24	D17	Yellow
D22	D18	Green
D21	E18	Green
D26	F17	Red
D27	F18	Red
D28	E17	Red
D29	F16	Red

Alpha-numeric LED Display

(See Appendix A, Sheet 8, Figure 20 - LEDs and Switches)

A 14-segment alpha-numeric display is provided on the board (D23). These LED segments are connected to general-purpose FPGA I/Os. The LEDs must be included in the FPGA design. The LEDs illuminate when the FPGA output is driven LOW. Table 9 shows the LED and associated FPGA pins. These pins are within an I/O bank connected to 2.5 V and the user should program these to be LVCMOS25 outputs in the design.

Figure 12. 14-Segment Display

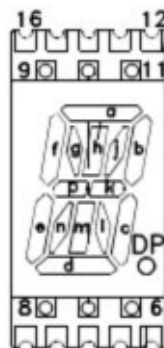

Table 9. Alpha-numeric LED Definitions

Display	FPGA Ball Number	Display	FPGA Ball Number
A	M20	J	N18
B	L18	K	P17
C	M19	L	N17
D	L16	M	P16
E	L17	N	R16
F	M18	P	R17
G	N16	DP	U1
H	M17		

DDR3 Memory Device

(See Appendix A, Sheet 7, Figure 19 - DDR3 Memory)

- The ECP5-5G Versa Development Board is equipped with an SDRAM memory device (1.5 V, 64 Mb/x16, 96-ball FBGA, 933 MHz, DDR3-1866) such as the Micron MT41K64M16TW-107:J device.
- The DDR3 memory includes a 16-bit wide memory controller interface.
- The board includes termination of data, address and command signals. It includes all power and external components needed to demonstrate the memory controller of the ECP5-5G device.
- A 100 MHz on-board clock oscillator is available to provide a DDR3 reference clock.

Table 10. DDR3 Memory Controller Interconnections

DDR3 Signal	FPGA Ball Number
DQ0	L5
DQ1	F1
DQ2	K4
DQ3	G1
DQ4	L4
DQ5	H1
DQ6	G2
DQ7	J3
DQ8	D1
DQ9	C1
DQ10	E2
DQ11	C2
DQ12	F3
DQ13	A2
DQ14	E1
DQ15	B1
DQS0	K2
DQS0#	J1
DQS1	H4
DQS1#	G5
CE0	N2
RAS#	P1
CLKP	P3
CLKN	P4
RST#	N4

DDR3 Signal	FPGA Ball Number
A0	P2
A1	C4
A2	E5
A3	F5
A4	B3
A5	F4
A6	B5
A7	E4
A8	C5
A9	E3
A10	D5
A11	B4
A12	C3
K_0	M4
K_0#	N5
CAS#	L1
BA0	P5
BA1	N3
BA2	M3
ODT	L2
CS0#	K1
WE#	M1
VREF	K5
DM0	J4
DM1	H5

Ethernet Interfaces

(See Appendix A, sheets 5 and 6 "10/100/1000-T PHY#x/RJ45")

Two Marvell 88E1512 Gigabit Ethernet transceiver devices (U14 and U15) are included on the board. These physical layer devices support 1000BASE-T, 100BASE-TX, and 10BASE-T applications via a standard media interface to a dual RJ45 connection. The RJ45 connection includes network magnetics providing the proper signal conditioning, electro-magnetic interference suppression and signal isolation. Each connector includes two LEDs which are controlled by the 88E1512 devices. Detailed descriptions are available in the Marvell device data sheet.

Table 11. PHY Status Indicators

LED	Status Description
RJ45 (Yellow)	Data RX/TX
RJ45 (Green/Orange)	Link State

Each Marvell 88E1512 device communicates via a RGMII interface to the ECP5-5G device.

Table 12. FPGA GPIO to RGMII Interfaces

Signal	Phy1	Phy2
CLK125	L19	J20
CLK125Pll	U16	C18
Config	T17	G20
Resetrn	U17	F20
TXCLK	P19	C20
TX_D0	N19	J17
TX_D1	N20	J16
TX_D2	P18	D19
TX_D3	P20	D20
TXCTRL	R20	E19
RXCLK	L20	J19
RX_D0	T20	G18
RX_D1	U20	G16
RX_D2	T19	H18
RX_D3	R18	H17
RXCTRL	U19	F19
MDIO	U18	H20
MDC	T18	G19

Table 13. Expansion Connections

X3 Expansion Connector		
Pin	Signal	FPGA Ball Number
1	GND	—
2	NC	—
3	2V5	—
4	IO29	B19
5	IO30	B12
6	IO31	B9
7	IO32	E6
8	IO33	D6
9	IO34	E7
10	IO35	D7
11	IO36	B11
12	IO37	B6
13	IO38	E9
14	IO39	D9
15	IO40	B8
16	IO41	C8
17	IO42	D8
18	IO43	E8
19	IO44	C7
20	IO45	C6
21	5VIN	—
22	GND	—
23	2V5	—
24	GND	—
25	3V3	—
26	GND	—
27	3V3	—
28	GND	—
29	OSC	—
30	GND	—
31	CLKIN	A10
32	GND	—
33	CLKOUT	E11
34	GND	—
35	3V3	—
36	GND	—
37	3V3	—
38	GND	—
39	3V3	—
40	GND	—

X4 Expansion Connector		
Pin	Signal	FPGA Ball Number
1	RESOUT#	A8
2	GND	—
3	IO0	A12
4	IO1	A13
5	IO2	B13
6	IO3	C13
7	IO4	D13
8	IO5	E13
9	IO6	A14
10	IO7	C14
11	IO8	D14
12	IO9	E14
13	IO10	D11
14	IO11	C10
15	IO12	A9
16	IO13	B10
17	IO14	D12
18	IO15	E12
19	GND	—
20	3V3	—
21	IO16	B15
22	GND	—
23	IO17	C15
24	GND	—
25	IO18	D15
26	GND	—
27	IO19	E15
28	IO20	A16
29	IO21	B16
30	GND	—
31	IO22	C16
32	IO23	D16
33	IO24	B17
34	GND	—
35	IO25	C17
36	IO26	A17
37	IO27	B18
38	CARDSEL#	A7
39	IO28	A18
40	GND	—

References

- DS1057, [ECP5-5G Family Data Sheet](#)
- UG112, [PCI Express Demos for the ECP5-5G Versa Development Board](#)
- UG111, [5.0 Gpbs SERDES Eye Demo for the ECP5-5G Versa Development Board](#)

Ordering Information

Description	Ordering Part Number	China RoHS Environment-Friendly Use Period (EFUP)
ECP5-5G Versa Development Board	LFE5UM5G-45F-VERSA-EVN	

Technical Support Assistance

Submit a technical support case through www.latticesemi.com/techsupport.

Revision History

Date	Version	Change Summary
January 2016	1.2	Updated General Purpose LEDs section. Revised FPGA ball numbers in Table 8, LED Definitions.
		Updated Appendix A. Schematics section. Revised LEDs signal map in Figure 20, LEDs and Switches.
		Updated Appendix B. Bill of Materials section. Revised description of item 111.
December 2015	1.1	Updated Ordering Information section. Corrected Ordering Part Number.
October 2015	1.0	Initial release.

© 2016 Lattice Semiconductor Corp. All Lattice trademarks, registered trademarks, patents, and disclaimers are as listed at www.latticesemi.com/legal. All other brand or product names are trademarks or registered trademarks of their respective holders. The specifications and information herein are subject to change without notice.

Appendix A. Schematics

Figure 13. Board Block Design

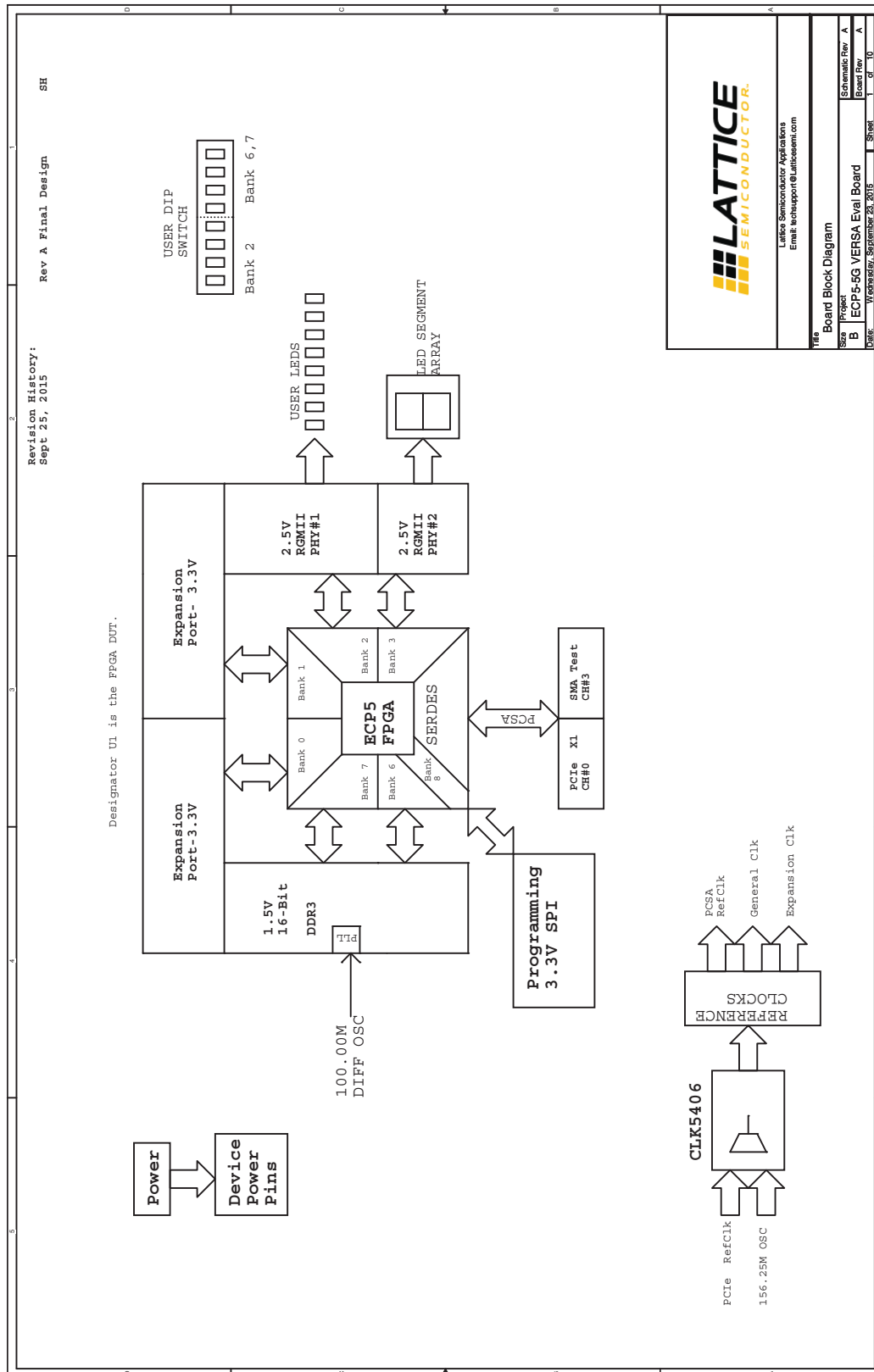

Figure 15. Programming

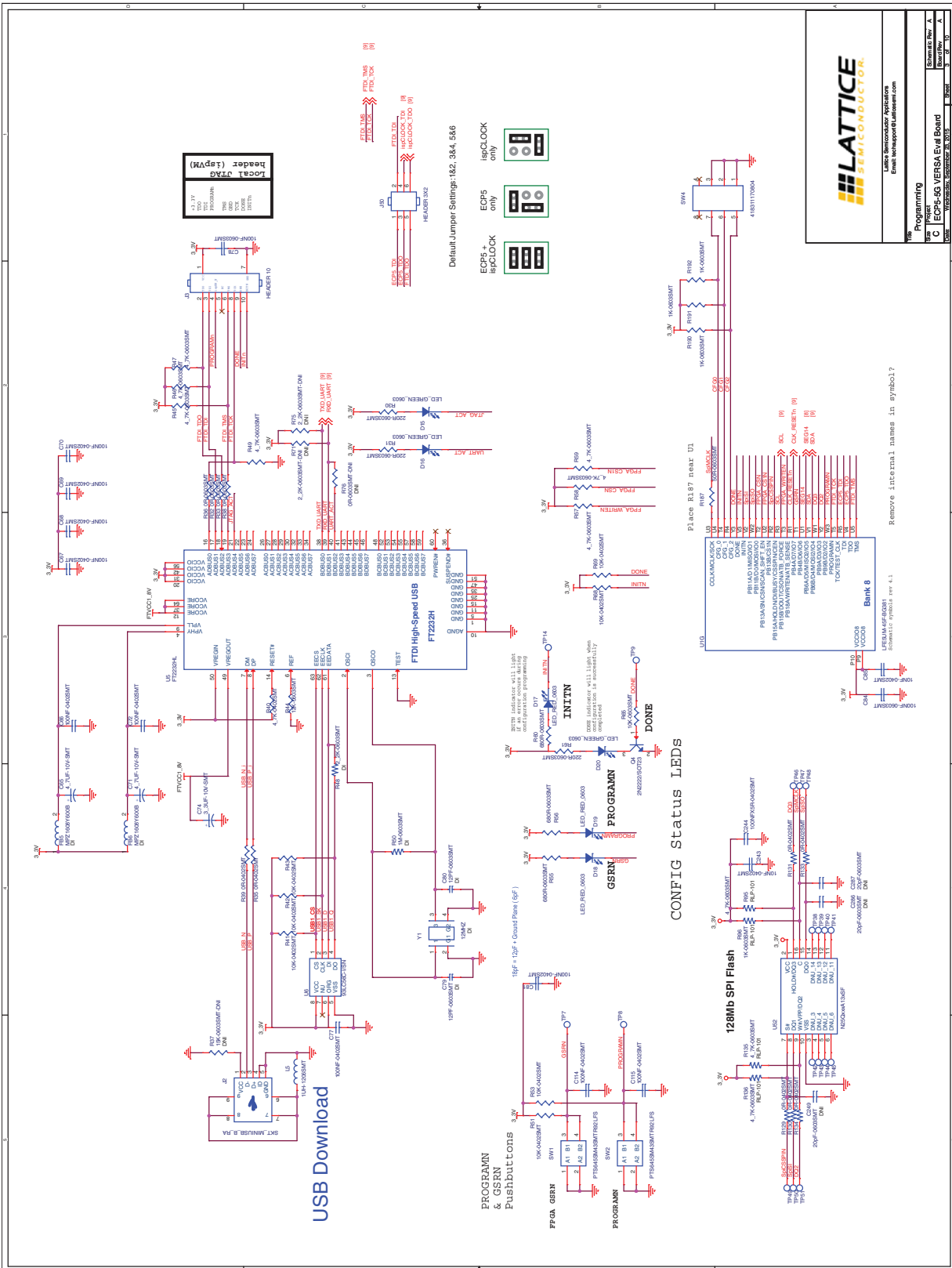
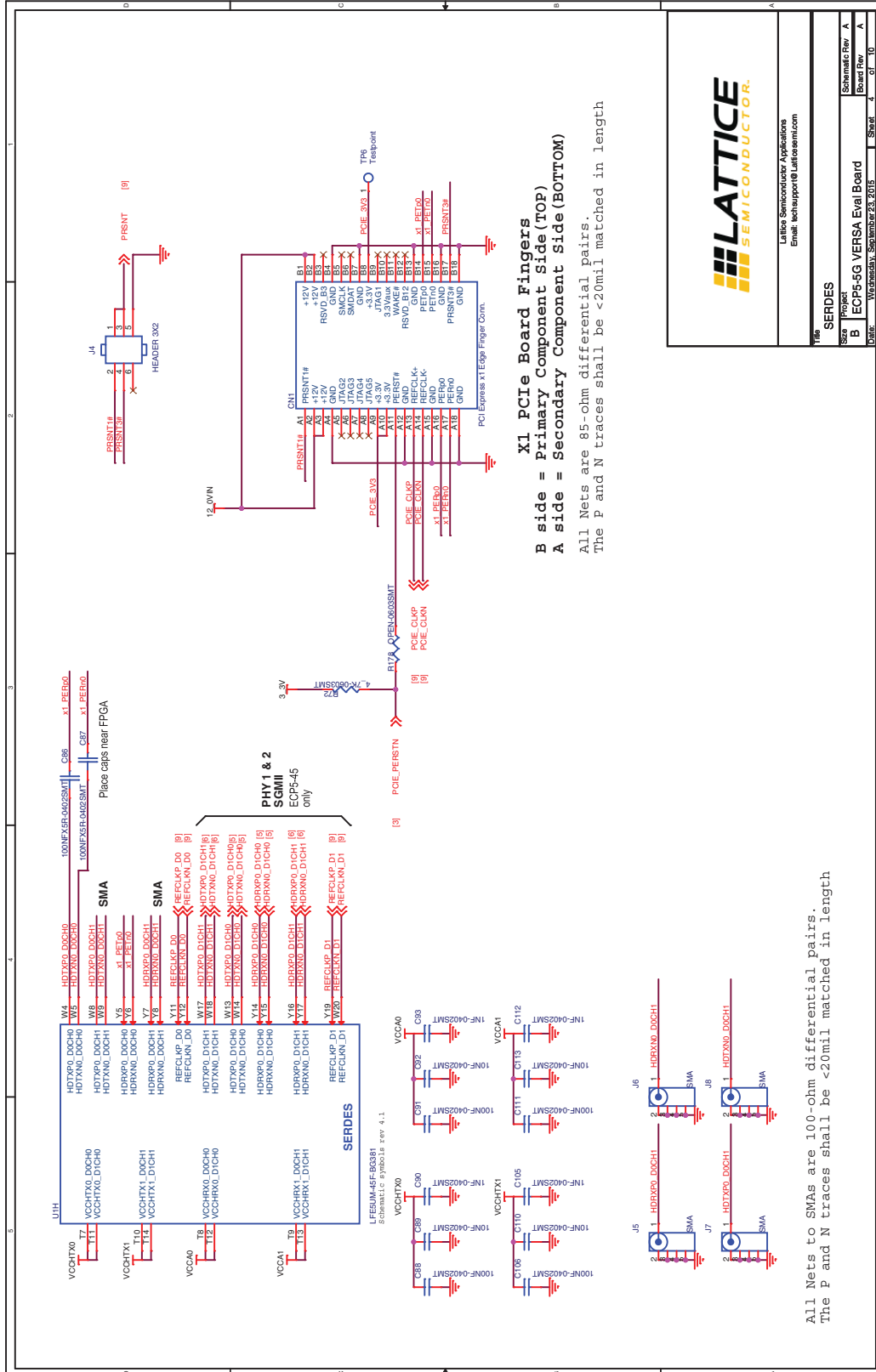
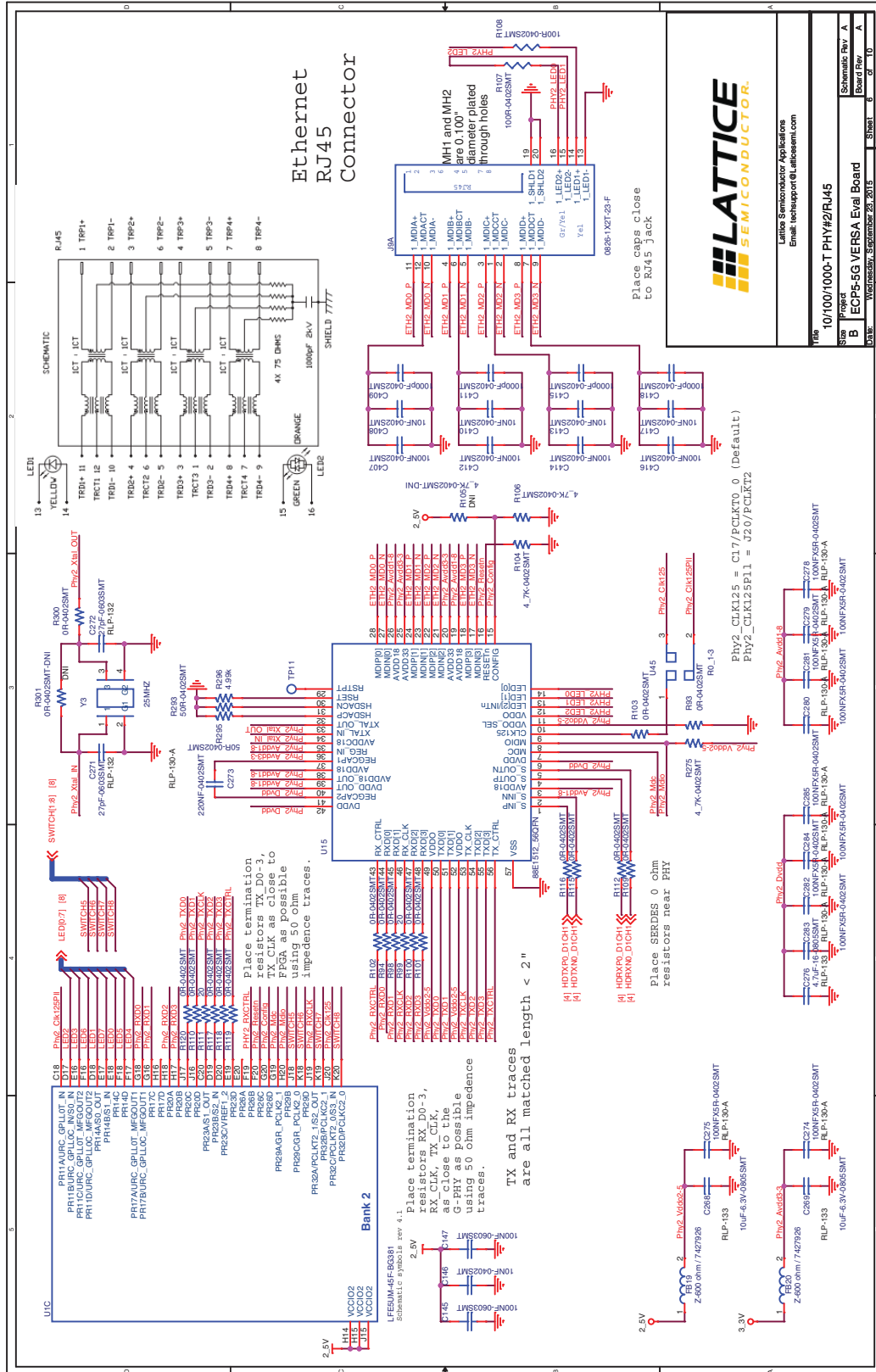

Figure 16. SERDES



All Nets to SMA are 100-ohm differential pairs.
 The P and N traces shall be <20mil matched in length.

Figure 18. 10/100/1000-T PHY #2/RJ45



Lattice Semiconductor Applications
Email: techsupport@lattice.com

Title: 10/100/1000-T PHY#2/RJ45
Project: ECP5-5G VERSA Eval Board
Sheet: 6 of 10

Figure 20. LEDs and Switches

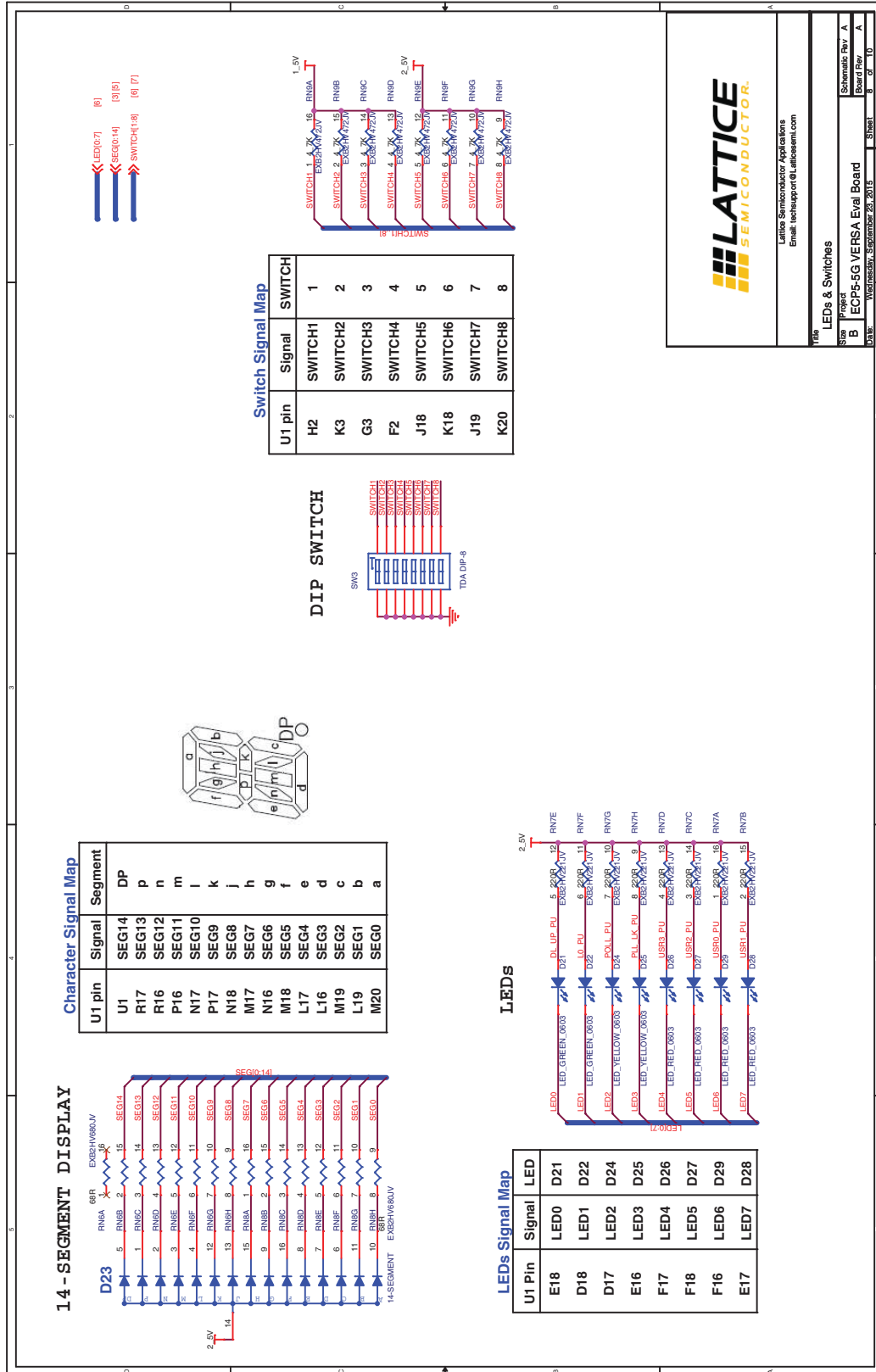
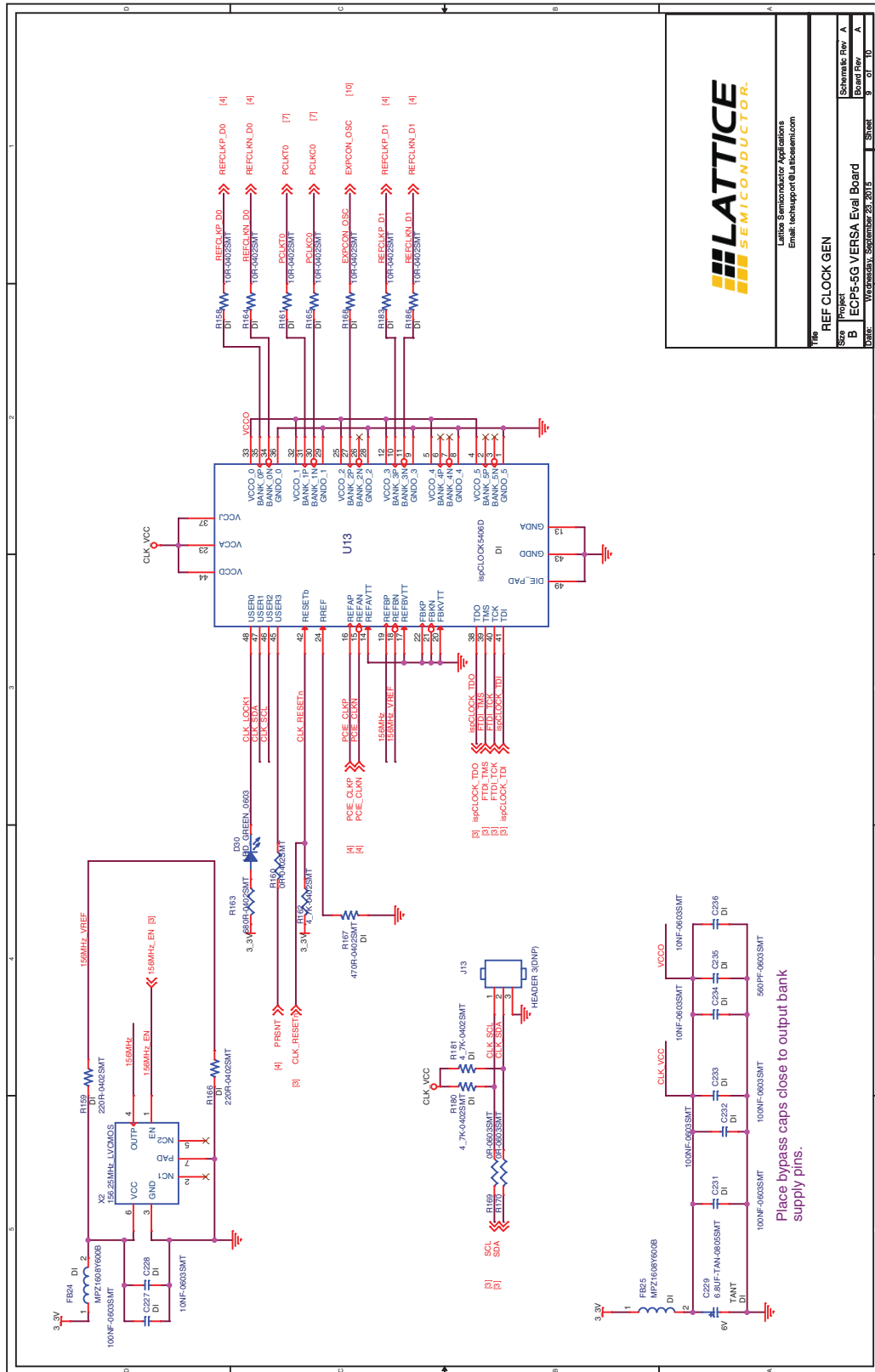

Figure 21. Reference Clock Generator



LATTICE
SEMICONDUCTOR.

Lattice Semiconductor Applications
Email: techsupport@lattice.com

REF CLOCK GEN

File	Project	Schematic Rev.
B	ECP5-5G VERSA Eval Board	A
Date	Wednesday, September 23, 2015	Sheet
		9 of 10

Appendix B. Bill of Materials

Table 14. ECP5-5G Versa Development Board Bill of Materials

Item	Quantity	Reference	Part	Manufacturer	Part Number	Description
1	1	CN1	PCI Express x1 Edge Finger Conn.			
2	31	C1,C2,C3,C4,C5,C20,C21,C29,C33,C85,C89,C92,C95,C108,C110,C113,C146,C202,C203,C206,C237,C239,C243,C396,C398,C401,C404,C408,C410,C413,C417	10NF-0402SMT	Panasonic	ECJ0EB1E103K	CAP .01 uF 25 V CERAMIC X7R 0402
3	32	C6,C7,C8,C9,C11,C22,C23,C28,C30,C34,C66,C67,C68,C69,C70,C72,C77,C81,C88,C91,C106,C111,C114,C115,C395,C399,C402,C405,C407,C412,C414,C416	100NF-0402SMT	Panasonic	ECJ-0EB1A104K	CAP .1 uF 10 V CERAMIC X5R 0402
4	8	C18,C25,C26,C36,C102,C104,C176,C180	22UF-16V-TANTBSMT	Kemet	T491B226M016AT	CAPACITOR TANT 22 uF 16 V 20% SMD
5	12	C19,C24,C27,C35,C101,C103,C171,C173,C178,C181,C391,C394	1UF-16V-0805SMT	Panasonic	ECJ-2FB1C105K	CAP 1 uF 16 V CERAMIC 0805 X5R
6	7	C31,C32,C90,C93,C94,C105,C112	1NF-0402SMT	TDK Corporation	C1005C0G1E102J	CAP CER 1000 pF 25 V C0G 5% 0402
7	2	C37,C51	10uF,25V-1206SMT	TDK Corporation	C3216Y5V1E106Z	CAP CER 10 uF 25 V Y5V 1206
8	6	C38,C39,C52,C53,C255,C273	220NF-0402SMT	TDK Corporation	C1005X7R1C224K050BC	CAP CER 0.22 uF 16 V X7R 10% 0402
9	10	C40,C41,C42,C49,C50,C54,C55,C58,C63,C64	22uF,6.3V-0805SMT	TDK Corporation	C2012X5R0J226M	CAP CER 22 uF 6.3 V X5R 20% 0805
10	12	C43,C44,C56,C57,C397,C400,C403,C406,C409,C411,C415,C418	1000pF-0402SMT	Panasonic	ECJ-0EB1E102K	CAP 1000 pF 25 V CERAMIC X7R 0402
11	4	C45,C48,C59,C62	330pF-0402SMT	TDK Corporation	C1005C0G1H331J	CAP CER 330 pF 50 V C0G 5% 0402
12	2	C46,C47,	10pF-0402SMT	TDK Corporation	C1005C0G1H100D	CAP CER 10 pF 50 V C0G 0402
13	2	C60,C61	10pF-0402SMT	DNI		
14	2	C65,C71	4_7UF-10V-SMT	TDK Corporation	C1608X5R1A475K	CAP CER 4.7 uF 10 V X5R 0603
15	1	C74	3_3UF-10V-SMT	TDK Corporation	C1608X5R1A335K	CAP CER 3.3 uF 10 V X5R 0603
16	33	C78,C84,C107,C109,C145,C147,C172,C174,C175,C183,C185,C186,C188,C189,C191,C193,C195,C197,C199,C201,C205,C218,C220,C222,C224,C225,C227,C231,C232,C233,C238,C240,C242	100NF-0603SMT	Panasonic	ECJ-1VF1C104Z	CAP .1 uF 16 V CERAMIC Y5V 0603
17	2	C79,C80	12PF-0603SMT	TDK Corporation	C1608C0G1H120J	CAP CER 12 pF 50 V C0G 5% 0603
18	25	C86,C87,C244,C247,C248,C256,C258,C260,C261,C262,C263,C264,C265,C266,C267,C274,C275,C278,C279,C280,C281,C282,C283,C284,C285	100NFx5R-0402SMT	Kemet	C0402C104K8PACTU	CAP .10 uF 10 V CERAMIC X5R 0402
19	1	C170	47UF-16V-TANTBSMT	Kemet	B45196H2476K209	CAP TANTALUM 47 uF 10 V 10% SMD
20	1	C177	100UF-D3POSCAP	Sanyo	6TPE100MI	100 uF 6.3 V D2E. POSCAP
21	1	C179	10UF-16V-TANTBSMT	AVX	TAJB106K016R	CAP TANTALUM 10 uF 16 V 10% SMD

Item	Quantity	Reference	Part	Manufacturer	Part Number	Description
22	19	C182,C184,C187,C190, C192,C194,C196,C198, C200,C204,C217,C219, C221,C223,C226,C228, C234,C236,C241	10NF-0603SMT	Kemet	C0603C103K5RACTU	CAP .01 uF 50 V CERAMIC X7R 0603
23	1	C229	6.8UF-TAN-0805SMT	Kemet	T494R685K006AS	CAP TANT 6.8 uF 6.3 V 10% SMD
24	1	C235	560PF-0603SMT	Kemet	C0603C561K5RACTU	CAP 560 pF 50 V CERAMIC X7R 0603
25	2	C245,C246	100pF-0402SMT	Panasonic	ECJ-0EB1E101K	CAP 100 pF 25 V CERAMIC X7R 0402
26	3	C249,C286,C287	20pF-0603SMT	TDK Corporation	C1608C0G1H200J	CAP CER 20 pF 50 V COG 5% 0603
27	6	C250,C251,C268,C269, C392,C393	10uF-6.3V-0805SMT	AVX	08056C106KAT2A	CAP CER 10 uF 6.3 V X7R 10% 0805
28	4	C253,C254,C271,C272	27pF-0603SMT	Kemet	C0603C270J5GACTU	CAP CERAMIC 27 pF 50 V NPO 0603
29	2	C257,C276	4.7uF-16-0805SMT	TDK Corporation	C2012Y5V1C475Z/0.85	CAP CER 4.7 uF 16 V Y5 V 0805
30	4	D1,D2,D5,D6	1N4448W	Fairchild	1N4448WT	DIODE 75V 200 mA SOD523F
31	4	D3,D4,D7,D8	DFLS220L	Diodes Inc	DFLS220L	DIODE SCHOTTKY 2A 20V PWRDI 123
32	11	D9,D10,D11,D12,D15,D16, D20,D21,D22,D30,D31	LED_GREEN_0603	Würth	150060VS75000	LED 1.6 mm x 0.8 mm 568NM GRN CLR SMD
33	1	D13	LED_BLUE_0603	Würth	150060BS75000	LED 1.6 mm x 0.8 mm 470 nM BL WTR CLR SMD
34	1	D14	SCHOTTKY/VISHAY- V12P10	Vishay	V12P10-M3/86A	DIODE SCHOTTKY 12A 100 V SMPC TO-277A
35	7	D17,D18,D19,D26,D27, D28,D29	LED_RED_0603	Würth	150060RS75000	LED 1.6 mm x 0.8 mm 625 nM RED CLR SMD
36	1	D23	14-SEGMENT	Kingbright	ACPSA04-41SRWA	LED Display
37	2	D24,D25	LED_YELLOW_0603	Würth	150060YS75000	LED 1.6 mm x 0.8 mm 588NM YLW CLR SMD
38	7	FB2,FB3,FB4,FB7,FB8, FB21,FB22	BLM41PG600SN1	Würth	742792410	FERRITE CHIP 60 Ohm 6000 mA 1806
39	5	FB5,FB6,FB23,FB24,FB25	MPZ1608Y600B	Würth	742792602	FERRITE CHIP 60 Ohm 2.3 A 0603
40	4	FB16,FB17,FB19,FB20	Z-600 Ohm / 7427926	Würth	74279265	FERRITE BEAD 600 Ohm .2 A 0603
41	1	F1	F1251CT-ND	Littlefuse	0154010.DR	FUSEBLOCK WITH 10 A FUSE SMD
42	1	J2	SKT_MINIUSB_B_RA	NELTRON	5075BMR-05-SM-CR	CONN MINI USB RCPT RA TYPE B SMD
43	1	J3	HEADER 10	Würth	61301011121	10x1-0.25 Header
44	2	J4,J50	HEADER 3X2	Würth	61300621121	3x2-0.25 Header
45	4	J5,J6,J7,J8	SMA	Molex	73391-0060	CONN JACK SMA STR 50 Ohm PCB
46	1	J9	0826-1X2T-23-F	Bellfuse	0826-1X2T-23-F	CONN MAGJACK 2PORT GIGABIT GO/Y
47	1	J11	PJ-002A	Würth	694106301002	
48	1	J13	HEADER 3(DNP)	DNI	TSW-103-07-T-S	3x1-0.25 Header
49	4	L1,L2,L3,L4	4.7uH-SPD62R-472M	API Delavan	SPD62R-472M	6.60 mm x 6.20 mm x 3.00 mm, 4.7 uH Power induc- tor
50	1	L5	1UH-1206SMT	Murata	LQM31PN1R0M00L	INDUCTOR 1.0 uH 1.2 A 1206
51	1	PP1	PROBEPOINT	DNI		
52	4	Q1,Q2,Q3,Q4	2N2222/SOT23	Diodes Inc	MMBT2222A-7	TRANS NPN 40V 350 MW SMD SOT-23
53	2	RN6,RN8	EXB2HV680JV	Panasonic	EXB2HV680JV	RES ARRAY 68 Ohm 5% 8 RES SMD

Item	Quantity	Reference	Part	Manufacturer	Part Number	Description
54	1	RN7	EXB2HV221JV	Panasonic	EXB2HV221JV	RES ARRAY 220 Ohm 5% 8 RES SMD
55	1	RN9	EXB2HV472JV	Panasonic	EXB2HV472JV	RES ARRAY 4.7K Ohm 5% 8 RES SMD
56	1	RP1	CTS-RT1402B7	CTS Corporation Resistor/Electrocomponents	RT2402B7	RES NET DDR SDRAM 50 Ohm 3X9 BGA
57	4	R6,R10,R12,R14	51K-0402SMT	Panasonic	ERJ-2RKF5102X	RES 51.0K Ohm 1/10 W 1% 0402 SMD
58	1	R7	21_5K-0603SMT	Panasonic	ERJ-3EKF2152V	RES 21.5K Ohm 1/10 W 1% 0603 SMD
59	1	R8	35_7K-0603SMT	Panasonic	ERJ-3EKF3572V	RES 35.7K Ohm 1/10 W 1% 0603 SMD
60	6	R9,R21,R27,R28,R29,R65	10K-0603SMT	Panasonic	ERJ-3EKF1002V	RES 10.0K Ohm 1/10 W 1% 0603 SMD
61	1	R11	34K-0402SMT	Panasonic	ERJ-2RKF3402X	RES 34.0K Ohm 1/10 W 1% 0402 SMD
62	1	R13	11_5K-0603SMT	Panasonic	ERJ-3EKF1152V	RES 11.5K Ohm 1/10 W 1% 0603 SMD
63	1	R15	5_11K-0603SMT	Panasonic	ERJ-3EKF5111V	RES 5.11K Ohm 1/10 W 1% 0603 SMD
64	1	R16	15K-0603SMT	Panasonic	ERJ-3EKF1502V	RES 15.0K Ohm 1/10 W 1% 0603 SMD
65	1	R17	16_9K-0603SMT	Panasonic	ERJ-3EKF1692V	RES 16.9K Ohm 1/10 W 1% 0603 SMD
66	1	R18	63_4K-0402SMT	Panasonic	ERJ-2RKF6342X	RES 63.4K Ohm 1/10 W 1% 0402 SMD
67	1	R19	30_1K-0402SMT	Panasonic	ERJ-2RKF3012X	RES 30.1K Ohm 1/10 W 1% 0402 SMD
68	1	R20	20K-0402SMT	Panasonic	ERJ-2RKF2002X	RES 20.0K Ohm 1/10 W 1% 0402 SMD
69	4	R22,R23,R24,R25	1_8K-1206SMT	Panasonic	ERJ-8ENF1801V	RES 1.80K Ohm 1/4 W 1% 1206 SMD
70	5	R26,R30,R31,R61,R179	220R-0603SMT	Panasonic	ERJ-3EKF2200V	RES 220 Ohm 1/10 W 1% 0603 SMD
71	11	R32,R33,R36,R38,R141, R145,R146,R169,R170, R175,R176	0R-0603SMT	Panasonic	ERJ-3GEY0R00V	RES 0.0 Ohm 1/10 W 0603 SMD
72	42	R35,R39,R52,R83,R84, R86,R87,R88,R89,R93, R94,R98,R100,R101,R102, R103,R109,R110,R112, R113,R115,R116,R117, R118,R119,R120,R121, R122,R123,R124,R125, R126,R127,R128,R129, R130,R131,R133,R134, R160,R298,R300	0R-0402SMT	Panasonic	ERJ-2GE0R00X	RES 0.0 Ohm 1/10 W 0402 SMD
73	1	R37	15K-0603SMT-DNI	DNI		
74	10	R40,R90,R92,R104,R106, R162,R180,R181,R274, R275	4_7K-0402SMT	Panasonic	ERJ-2RKF4701X	RES 4.70K Ohm 1/10 W 1% 0402 SMD
75	8	R41,R42,R43,R51,R53, R68,R69,R157	10K-0402SMT	Panasonic	ERJ-2RKF1002X	RES 10.0K Ohm 1/10 W 1% 0402 SMD
76	1	R44	12K-0603SMT	Panasonic	ERJ-3EKF1202V	RES 12.0K Ohm 1/10 W 1% 0603 SMD
77	12	R45,R46,R47,R49,R57, R58,R59,R72,R95,R135, R136,R142	4_7K-0603SMT	Panasonic	ERJ-3EKF4701V	RES 4.70K Ohm 1/10 W 1% 0603 SMD
78	1	R48	2_2K-0603SMT	Panasonic	ERJ-3EKF2201V	RES 2.20K Ohm 1/10 W 1% 0603 SMD
79	1	R50	1M-0603SMT	Panasonic	ERJ-3EKF1004V	RES 1.00M Ohm 1/10 W 1% 0603 SMD
80	3	R55,R56,R60	680R-0603SMT	Panasonic	ERJ-3EKF6800V	RES 680 Ohm 1/10 W 1% 0603 SMD

Item	Quantity	Reference	Part	Manufacturer	Part Number	Description
81	5	R63,R64,R66,R67,R70	0.1	Vishay Dale	WSL2010R1000FEA	RES .1 Ohm 1/2 W 1% 2010 SMD
82	2	R71,R75	2_2K-0603SMT-DNI	DNI		
83	5	R73,R74,R107,R108,R156	100R-0402SMT	Panasonic	ERJ-2RKF1000X	RES 100 Ohm 1/10 W 1% 0402 SMD
84	1	R76	0R-0603SMT-DNI	DNI		
85	4	R85,R99,R111,R114	20	Vishay	CRCW040220R0FKED	RES 20.0 Ohm 1/16 W 1% 0402 SMD
86	2	R91,R105	4_7K-0402SMT-DNI	DNI		
87	4	R96,R190,R191,R192	1K-0603SMT	Panasonic	ERJ-3EKF1001V	RES 1.00K Ohm 1/10 W 1% 0603 SMD
88	1	R140	0.01	Vishay Dale	WSL2512R0100FEA18	RES .01 Ohm 2 W 1% 2512 SMD
89	5	R143,R144,R148,R149,R178	OPEN-0603SMT	DNI		
90	1	R147	240R-0603SMT	Panasonic	ERJ-3EKF2400V	RES 240 Ohm 1/10 W 1% 0603 SMD
91	10	R150,R151,R152,R153,R154,R155,R291,R292,R293,R295	50R-0402SMT	Vishay	FC0402E50R0FST1	RES 50 Ohm 50 MW +/- 1% 0402 SMD
92	7	R158,R161,R164,R165,R168,R183,R186	10R-0402SMT	Panasonic	ERJ-2RKF10R0X	RES 10.0 Ohm 1/10 W 1% 0402 SMD
93	2	R159,R166	220R-0402SMT	Panasonic	ERJ-2RKF2200X	RES 200 Ohm 1/10 W 1% 0402 SMD
94	1	R163	680R-0402SMT	Panasonic	ERJ-2RKF6800X	RES 680 Ohm 1/10 W 1% 0402 SMD
95	1	R167	470R-0402SMT	Panasonic	ERJ-2RKF4700X	RES 470 Ohm 1/10 W 1% 0402 SMD
96	1	R177	0R-0603SMT- DNI	DNI		
97	1	R184	121K-0603SMT	Panasonic	ERJ-3EKF1213V	RES 121K Ohm 1/10 W 1% 0603 SMD
98	1	R185	110K-0603SMT	Panasonic	ERJ-3EKF1103V	RES 110K Ohm 1/10 W 1% 0603 SMD
99	1	R187	50R-0603SMT	Panasonic	ERJ-3EKF49R9V	RES 49.9 Ohm 1/10 W 1% 0603 SMD
100	2	R294,R296	4.99k	Panasonic	ERJ-2RKF4991X	RES 4.99K Ohm 1/10W 1% 0402 SMD
101	2	R299,R301	0R-0402SMT-DNI	DNI		
102	2	SW1,SW2	PTS645SM43SMTR92 LFS	Würth	430483031816	SPST SMD
103	1	SW3	TDA DIP-8	Würth	416131160808	8-DIP
104	1	SW4	418311170804	Würth	418311170804	4 poles raised SMT
105	4	TH1,TH2,TH3,TH4	ThruHole	DNI		
106	39	TP1,TP2,TP3,TP4,TP5,TP6,TP7,TP8,TP9,TP10,TP11,TP12,TP13,TP14,TP15,TP16,TP17,TP18,TP19,TP20,TP21,TP22,TP23,TP24,TP25,TP38,TP39,TP40,TP41,TP42,TP43,TP44,TP45,TP46,TP47,TP48,TP49,TP50,TP51	TestPoint	DNI		
107	1	U1	LFE5UM5G-45F-BG381	LATTICE SUPPLIED	LFE5UM5G-45F-8BG381IES	
108	2	U3,U4	LT3508EUF	LATTICE SUPPLIED	LT3508EUF#PBF	Dual Monolithic 1.4 A Step-Down Switching Regulator
109	1	U5	FT2232HL	FTDI	FTD2232HL	USB-UART/JTAG
110	1	U6	93LC56C-I/SN	MicroChip	93LC56C-I/SN	IC EEPROM 2 Kbit 3 MHz 8SOIC
111	1	U11	ddr3-96bga	Micron	MT41K64M16TW-107:J	64Mb/x16, 1.5 V, 96-ball FBGA, 667 MHz, DDR3-1866

Item	Quantity	Reference	Part	Manufacturer	Part Number	Description
112	1	U12	LP2998-SO8	National	LP2998MAX/NOPB	Termination regulator
113	1	U13	ispCLOCK5406D	LATTICE SUPPLIED	ISPPAC-CLK5406D-01SN48I	
114	2	U14,U15	88E1512_56QFN	Marvell	88E1512-A0-NNP2C000	SINGLE-PORT EEE GIGABIT ETHER
115	2	U44,U45	R0_1-3	Panasonic	ERJ-3GEY0R00V	RES 0.0 Ohm 1/10 W 0603 SMD
116	1	U52	N25QxxxA13xSF	Micron	N25Q128A13ESF40G	Serial Flash
117	2	U53,U54	LT3085	LATTICE SUPPLIED	LT3085EMS8E#PBF	Adjustable 500 mA Single Resistor Low Dropout Regulator
118	1	X1	100_00MHz_LVDS	SiTime	SIT9120AC-2D2-33E100.000	100 MHz Low-Jitter LVDS Clock Osc., 7 mm x 5 mm, 50 ppm
119	1	X2	156.25MHz_LVCMOS	SiTime	SIT8256AI-83-33E-156.250T	156.25 MHz Single ended CMOS Clock Osc., 7 mm x 5 mm
120	2	X3,X4	HDR40	Würth	61304021121	HEADER 40POS .100" DL TIN
121	1	Y1	12MHZ	TXC	7M-12.000MAAJ-T	CRYSTAL 12.0000 MHz 18 pF SMD
122	2	Y2,Y3	25MHZ	TXC	7M-25.000MAAJ-T	CRYSTAL 25.0000 MHz 18 pF SMD

X-ON Electronics

Largest Supplier of Electrical and Electronic Components

Click to view similar products for [Programmable Logic IC Development Tools](#) category:

Click to view products by [Lattice](#) manufacturer:

Other Similar products are found below :

[HLDC-DDR3-A](#) [DK-DEV-5SGXEA7N](#) [EK-10M50F484](#) [EPXA4F672C2](#) [EPXA4F672C3](#) [EPXA4F672C1](#) [K0161](#) [LCMXO256C-S-EVN](#)
[12GSDIFMCCD](#) [SFP+X4FMCCD](#) [88980182](#) [P0582](#) [HW-PWAC-2600317](#) [DEV-17514](#) [LCMXO3D-9400HC-B-EVN](#) [P0671](#) [DK-K7-](#)
[CONN-G](#) [P0467](#) [LCMXO2-1200ZE-P1-EVN](#) [LCMXO2-4000HE-DSIB-EVN](#) [DK-DEV-4SGX530N](#) [LCMXO3L-SMA-EVN](#) [P006-006-2](#)
[EK-U1-VCU108-G](#) [A2F500-DEV-KIT-2](#) [LCMXO3LF-9400C-ASC-B-EVN](#) [471-014](#) [EVAL-TPG-ZYNQ3](#) [SL001](#) [80-001005](#) [P0466-EDU](#)
[EK-10CL025U256](#) [P0496](#) [P0493](#) [DK-SOC-10AS066S-A](#) [DK-DEV-10CX220-A](#) [80-001002](#) [iCE40UP5K-MDP-EVN](#) [RXCA10S066PF34-](#)
[IDK00A](#) [ALTSODIAC5ST](#) [ALTHYDRAC5GX](#) [ALTNITROC5GX](#) [ALTBERYLLC5GX](#) [471-015](#) [LFE3-17EA-USB3-EVN](#) [1553](#) [4332](#) [Hinj](#)
[HinjKit](#) [SNOMAKRKIT](#)