

THE INFORMATION CONTAINED IN THIS DRAWING IS THE SOLE PROPERTY OF L-COM, INC. ANY REPRODUCTION IN PART OR WHOLE WITHOUT THE WRITTEN PERMISSION OF L-COM, INC. IS PROHIBITED.

REVISIONS			
REV	DESCRIPTION	DATE	APPROVED
A	INITIAL RELEASE	01/23/18	JLABOY

WIRING MAP	
"P1"	"J1"
1	1
2	2
3	3
4	4
5	5
6	6
7	7
8	8
9	9
SHELL	SHELL

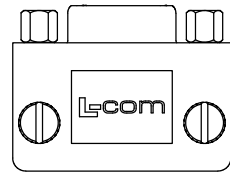
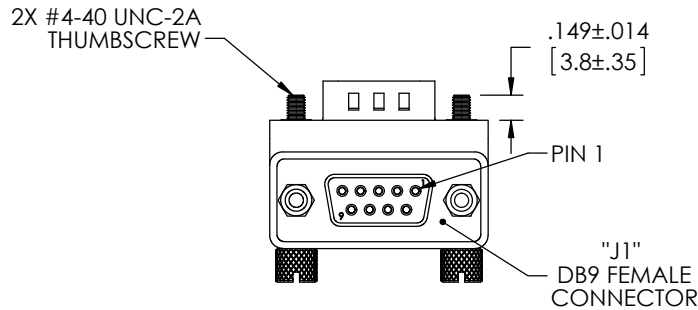
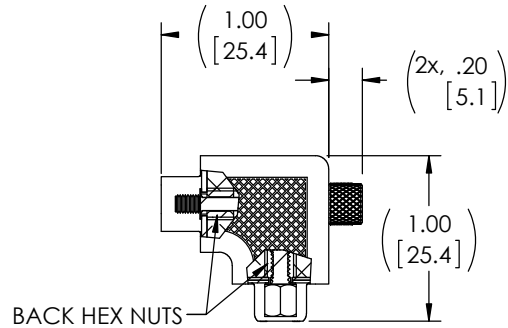
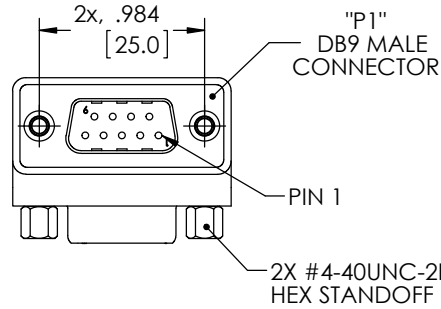
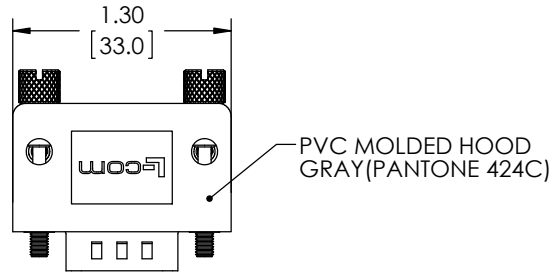

HARDWARE CONFIGURATIONS

STANDARD HARDWARE CONFIGURATION

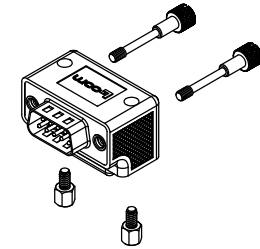

ALTERNATE HARDWARE CONFIGURATION

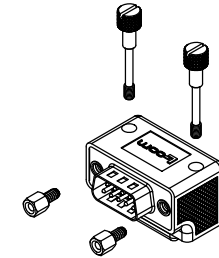

NOTES:

- ADAPTER SHALL BE TESTED FOR CONTINUITY.
- ADAPTER SHALL BE INDIVIDUALLY PACKAGED IN ACCORDANCE WITH L-COM SPECIFICATION PS-0031.
- PRODUCT SHIPPED IN STANDARD HARDWARE CONFIGURATION SHOWN ABOVE AND IN EXPLODED VIEW.
- OPERATING TEMPERATURE RANGE: -15°C~+70°C

REGULATORY COMPLIANCE:
CE2011/65/EU(ROHS DIRECTIVE)

UNLESS OTHERWISE SPECIFIED, DIMENSIONS ARE IN INCHES [mm] OVERALL CABLE LENGTH TOLERANCE: ≤12 [305] = +1 [25] / -0 >12 [305] ≤60 [1524] = +2 [51] / -0 >60 [1524] ≤120 [3048] = +4 [102] / -0 >120 [3048] ≤300 [7620] = +6 [152] / -0 >300 [7620] = +5% / -0% ALL OTHER DIMENSIONAL TOLERANCES: .X = ± .2 [5.08] .XX = ± .02 [51] .XXX = ±.005 [1.13]	APPROVALS DRAWN BY B.ZHANG CHECKED BY J.LABOY APPROVED BY B.GATES	DATE 01/19/2018 01/19/2018 01/19/2018	50 HIGH STREET NORTH ANDOVER, MA 01845	
	CONFIGURATION DETAILS OF UNDIMENSIONED FEATURES MAY VARY			CATEGORY D-SUBMINIATURE
	PROJECTION 			PRODUCT DESCRIPTION ADPT,DB9M/F RA ORIENTATION 1 PREMIUM VERSION
	COLOR VARIATIONS MAY OCCUR	SIZE A		FSCM NO. 43321
SCALE: NONE		CAD FILE: DG909MF1-P.SLDDRW	SHEET 1 OF 1	

X-ON Electronics

Largest Supplier of Electrical and Electronic Components

Click to view similar products for [L-Com](#) manufacturer:

Other Similar products are found below :

[27-500-010](#) [AL-ECF504-AB](#) [ANM-1406](#) [AOCQP28100-007](#) [AOCQSP40-010](#) [AOCSP10-002](#) [BA35FF](#) [BAK400](#) [BC030B](#) [BC030R](#) [BC25](#)
[BC40](#) [BC50](#) [BC55](#) [BTB5MD](#) [CA3A-90DA-05M](#) [CA3A-90LA-1M](#) [CA3A-90RA-05M](#) [CA3A-90RMICB-05M](#) [CA3N030](#) [CA3N050](#)
[CA90DA-90DB-03M](#) [CAPUSB-A](#) [CAPUSB-B](#) [CAP-WPRJ](#) [CA-RSPNMB010](#) [CASATAL-18](#) [CASATARL-12](#) [CAUALAL-1M](#)
[CAUALAL-2M](#) [CAUALAL-3M](#) [CAUALB-1M](#) [CAUBLKAA-2M](#) [CAUBLKAB-05M](#) [CAUBLKAB-1M](#) [CAUBLKAB-3M](#) [CAUBLKAB-](#)
[4M](#) [CAUBLKAB-5M](#) [CC58C-10](#) [CC58C-12](#) [CC58C-2](#) [CC58C-5](#) [CC59A-25](#) [CG-C6A-MF](#) [CG-C6-MF](#) [CGDVIMM-10](#) [CGSVGAMM-10](#)
[CIB24-05M](#) [CIB24-1M](#) [CIB24-2M](#)