

DESCRIPTION

LC1117 is a series of low dropout three-terminal regulators with a dropout of 1.3V at 1A load current. LC1117 features a low standby current 2mA.

Other than a fixed version ($V_{out} = 1.2V, 1.5V, 1.8V, 2.5V, 3.3V, 5V, \text{ and } 12V$), LC1117 has an adjustable version, which can provide an output voltage from 1.25 to 12V with only two external resistors.

LC1117 offers thermal shut down and current limit functions, to assure stability of chip and power system. Trimming technique is used to guarantee output voltage accuracy within $\pm 2\%$. Other output voltage accuracy such as $\pm 1\%$ can be customized on demand.

LC1117 is available in SOT-223, TO-252 power packages.

FEATURES

- Other than a fixed version and an adjustable version, output value can be customized on demand.
- Maximum output current is 1A
- Range of operation input voltage: Max 18V
- Standby current: 2mA (typ.)
- Line regulation: 0.1%/V (typ.)
- Load regulation: 10mV (typ.)
- Environment Temperature: $-40^{\circ}C \sim 85^{\circ}C$
- Compatible with tantalum capacitor, electrolytic capacitor and MLCC.

APPLICATIONS

- Power Management for Computer Mother Board, Graphic Card
- LCD Monitor and LCD TV
- DVD Decode Board
- ADSL Modem
- Post Regulators for Switching Supplies

TYPICAL APPLICATION

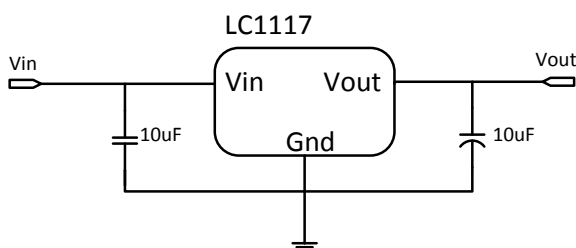

Application circuit of LC1117 fixed version

TYPICAL ELECTRICAL CHARACTERISTIC

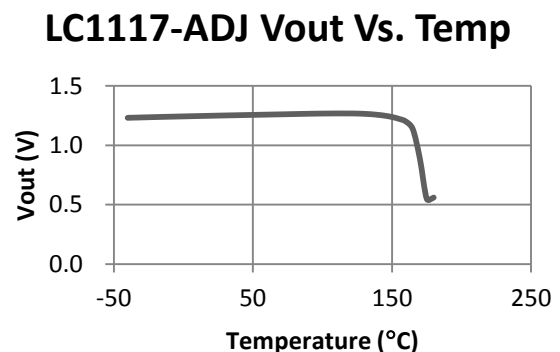

ORDERING INFORMATION

LC1117 [1](#) [2](#) [3](#) [4](#) [5](#)

Code	Description
1	Temperature&Rohs: C:-40~85°C ,Pb Free Rohs Std.
2	Package type: L:SOT-223 O:TO-252
3	Packing type: TR:Tape&Reel (Standard)
4	Output voltage: e.g. 12=1.2V 15=1.5V 18=1.8V 25=2.5V 33=3.3V 50=5.0V 120=12V AD=Output adjustable
5	Voltage accuracy: 1=±1%(Customized) Blank(default)=±2%

PIN CONFIGURATION

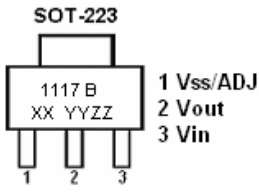
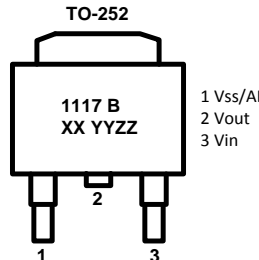
Product Classification		LC1117CLTR 1 2
Marking		
1117 B XXYYZZ	1117: Product Code	
	B: Fab Code	
	XX: Output Voltage	
	YY: Lot No.	
	ZZ: Date Code	
Product Classification		LC1117COTR 1 2
Marking		
1117 B XXYYZZ	1117: Product Code	
	B: Fab Code	
	XX: Output Voltage	
	YY: Lot No.	
	ZZ: Date Code	
Vss/Adj	Ground Pin/Adjustable	
Vin	Supply Voltage Input	
Vout	Output Voltage	

ABSOLUTE MAXIMUM RATING

Parameter		Value
Max Input Voltage		18V ^①
Max Operating Junction Temperature(Tj)		150°C
Ambient Temperature(Ta)		-40°C – 85°C
Package Thermal Resistance(θjc)	SOT-223	20°C / W
	TO-252	12.5°C / W
Storage Temperature(Ts)		-40°C - 150°C
Lead Temperature & Time		260°C, 10S

Note: Exceed these limits to damage to the device. Exposure to absolute maximum rating conditions may affect device reliability.

RECOMMENDED WORK CONDITIONS

Parameter	Value
Input Voltage Range	Max. 16V ^①
Operating Junction Temperature(Tj)	-40°C –125°C

^①Exceptional for LC1117-12V, the maximum input voltage for LC1117-12V is 20V.

ELECTRICAL CHARACTERISTICS

T_j=25°C

Symbol	Parameter	Conditions	Min	Typ	Max	Unit
Vref	Reference Voltage	LC1117-ADJ 10mA ≤ I _{out} ≤ 1A, V _{in} = 3.25V	1.225	1.25	1.275	V
Vout	Output Voltage	LC1117-1.2V 0 ≤ I _{out} ≤ 1A, V _{in} = 3.2V	1.176	1.2	1.224	V
		LC1117-1.5V 0 ≤ I _{out} ≤ 1A, V _{in} = 3.5V	1.47	1.5	1.53	V
		LC1117-1.8V 0 ≤ I _{out} ≤ 1A, V _{in} = 3.8V	1.764	1.8	1.836	V
		LC1117-2.5V 0 ≤ I _{out} ≤ 1A, V _{in} = 4.5V	2.45	2.5	2.55	V
		LC1117-3.3V 0 ≤ I _{out} ≤ 1A, V _{in} = 5.3V	3.234	3.3	3.366	V
		LC1117-5.0V 0 ≤ I _{out} ≤ 1A, V _{in} = 7.0V	4.9	5	5.1	V
		LC1117-12.0V 0 ≤ I _{out} ≤ 1A, V _{in} = 14V	11.76	12	12.24	V
		ΔVout	Line Regulation	LC1117-1.2V I _{out} = 10mA, 2.7V ≤ V _{in} ≤ 15V		0.1
LC1117-ADJ I _{out} = 10mA, 2.75V ≤ V _{in} ≤ 16V				0.1	0.2	%/V
LC1117-1.5V I _{out} = 10mA, 3.0V ≤ V _{in} ≤ 16V				0.1	0.2	%/V
LC1117-1.8V I _{out} = 10mA, 3.3V ≤ V _{in} ≤ 16V				0.1	0.2	%/V
LC1117-2.5V I _{out} = 10mA, 4.0V ≤ V _{in} ≤ 16V				0.1	0.2	%/V
LC1117-3.3V I _{out} = 10mA, 4.8V ≤ V _{in} ≤ 16V				0.1	0.2	%/V
LC1117-5.0V I _{out} = 10mA, 6.5V ≤ V _{in} ≤ 16V				0.1	0.2	%/V
LC1117-12.0V I _{out} = 10mA, 13.5V ≤ V _{in} ≤ 20V				0.1	0.2	%/V
ΔVout	Load Regulation	LC1117-ADJ V _{in} = 2.7V, 10mA ≤ I _{out} ≤ 1A		10	30	mV
		LC1117-ADJ V _{in} = 2.75V, 10mA ≤ I _{out} ≤ 1A		10	30	mV
		LC1117-1.5V V _{in} = 3.0V, 10mA ≤ I _{out} ≤ 1A		10	30	mV
		LC1117-1.8V V _{in} = 3.3V, 10mA ≤ I _{out} ≤ 1A		10	30	mV
		LC1117-2.5V V _{in} = 4.0V, 10mA ≤ I _{out} ≤ 1A		10	30	mV
		LC1117-3.3V V _{in} = 4.8V, 10mA ≤ I _{out} ≤ 1A		10	30	mV
		LC1117-5.0V V _{in} = 6.5V, 10mA ≤ I _{out} ≤ 1A		10	30	mV
		LC1117-12.0V V _{in} = 13.5V, 10mA ≤ I _{out} ≤ 1A		10	30	mV

ELECTRICAL CHARACTERISTICS continued

T_j=25°C

Symbol	Parameter	Conditions	Min	Typ	Max	Unit
Vdrop	Dropout Voltage	I _{out} =100mA		1.23	1.3	V
		I _{out} =1A		1.3	1.5	V
I _{limit}	Current Limit	V _{in} -V _{out} =2V, T _j =25°C	1			A
I _{min}	Minimum Load Current	LC1117-ADJ		2	10	mA
I _q	Quiescent Current	LC1117-1.2V, V _{in} =10V		2	5	mA
		LC1117-1.5V, V _{in} =12V		2	5	mA
		LC1117-1.8V, V _{in} =12V		2	5	mA
		LC1117-2.5V, V _{in} =12V		2	5	mA
		LC1117-3.3V, V _{in} =12V		2	5	mA
		LC1117-5.0V, V _{in} =12V		2	5	mA
		LC1117-12.0V, V _{in} =20V		2	5	mA
I _{Adj}	Adjust Pin Current	LC1117-ADJ V _{in} =5V, 10mA ≤ I _{out} ≤ 1A		55	120	uA
I _{change}	I _{adj} change	LC1117-ADJ V _{in} =5V, 10mA ≤ I _{out} ≤ 1A		0.2	10	uA
ΔV/ΔT	Temperature coefficient			±100		ppm
θ _{JC}	Thermal Resistance	SOT-223		20		°C/W
		TO-252		10		
		TO-220		4.5		

Note1: All test are conducted under ambient temperature 25°C and within a short period of time 20ms

Note2: Load current smaller than minimum load current of LC1117-ADJ will lead to unstable or oscillation output.

BLOCK DIAGRAM

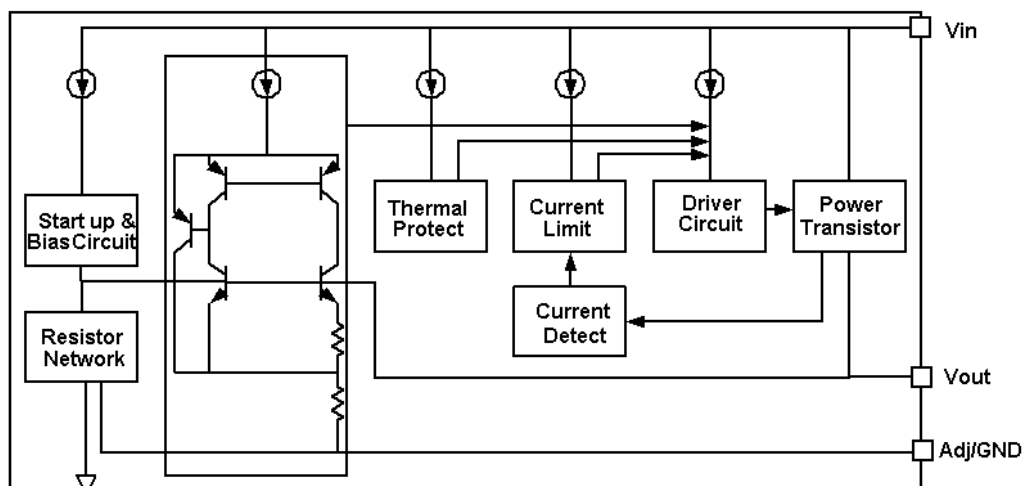

DETAILED DESCRIPTION

LC1117 is a series of low dropout voltage, three terminal regulators. Its application circuit is very simple: the fixed version only needs two capacitors and the adjustable version only needs two resistors and two capacitors to work. It is composed of some modules including start-up circuit, bias circuit, bandgap, thermal shutdown, current limit, power transistors and its driver circuit and so on.

The thermal shut down modules can assure chip and its application system working safety when the junction temperature is larger than 140°C.

The bandgap module provides stable reference voltage, whose temperature coefficient is compensated by careful design considerations. The temperature coefficient is under 100 ppm/°C. And the accuracy of output voltage is guaranteed by trimming technique.

TYPICAL APPLICATION

LC1117 has an adjustable version and six fixed versions (1.2V, 1.5V, 1.8V, 2.5V, 3.3V, 5V and 12V)

Fixed Output Voltage Version

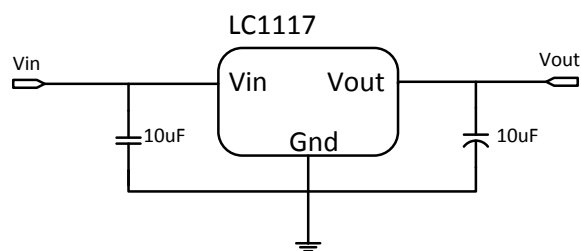

Application circuit of LC1117 fixed version

- 1) Recommend using 10µF tan capacitor as bypass capacitor (C1) for all application circuit.
- 2) Recommend using 10µF tan capacitor to assure circuit stability.

Adjustable Output Voltage Version

LC1117-ADJ provides a 1.25V reference voltage. Any output voltage between 1.25V~12V can be achievable by choosing two external resistors (schematic is shown below), R1 and R2

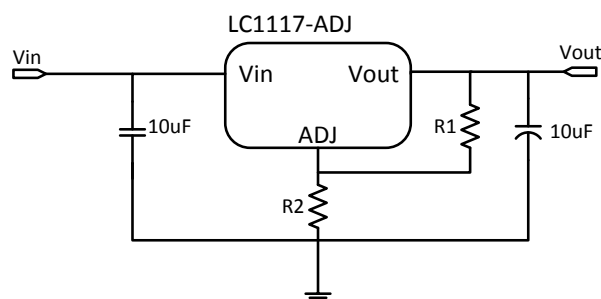

Application Circuit of LC1117-ADJ

The output voltage of adjustable version follows the equation: $V_{out} = 1.25 \times (1 + R2/R1) + I_{Adj} \times R2$. We can ignore I_{Adj} because I_{Adj} (about 50µA) is much less than the current of R1 (about 2~10mA).

- 1) To meet the minimum load current (>10mA) requirement, R1 is recommended to be 125ohm or lower. As LC1117-ADJ can keep itself stable at load current about 2mA, R1 is not allowed to be higher than 625ohm.
- 2) Using a bypass capacitor (C_{ADJ}) between the ADJ pin and ground can improve ripple rejection. This bypass capacitor prevents ripple from being amplified as the output voltage is increased. The impedance of C_{ADJ} should be less than R1 to prevent ripple from being amplified. As R1 is normally in the range of 100Ω~500Ω, the value of C_{ADJ} should satisfy this equation: $1/(2\pi \times f_{ripple} \times C_{ADJ}) < R1$.

THERMAL CONSIDERATIONS

We have to take heat dissipation into great consideration when output current or differential voltage of input and output voltage is large. Because in such cases, the power dissipation consumed by LC1117 is very large. LC1117 series uses SOT-223 package type and its thermal resistance is about 20°C/W. And the copper area of application board can affect the total thermal resistance. If copper area is 5cm*5cm (two sides), the resistance is about 30°C/W. So the total thermal resistance is about 20°C/W + 30°C/W. We can decrease total thermal resistance by increasing copper area in application board. When there is no good heat dissipation copper are in PCB, the total thermal resistance will be as high as 120°C/W, then the power dissipation of LC1117 could allow on itself is less than 1W. And furthermore, LC1117 will work at junction temperature higher than 125°C under such condition and no lifetime is guaranteed.

TYPICAL PERFORMANCE CHARACTERISTICS

T=25°C unless specified.

Line Regulation

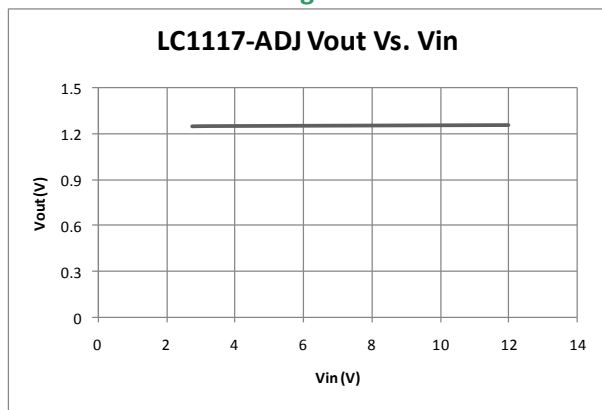

Load Regulation

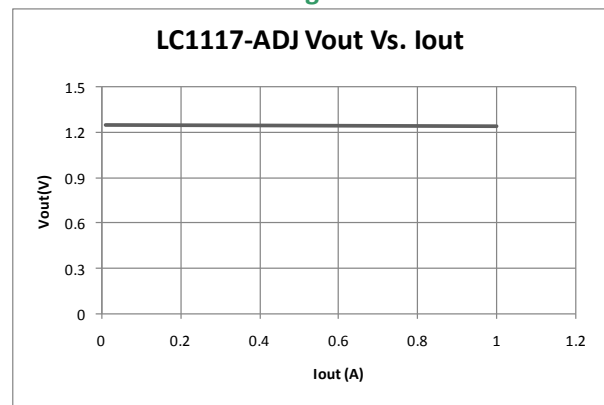

Dropout Voltage

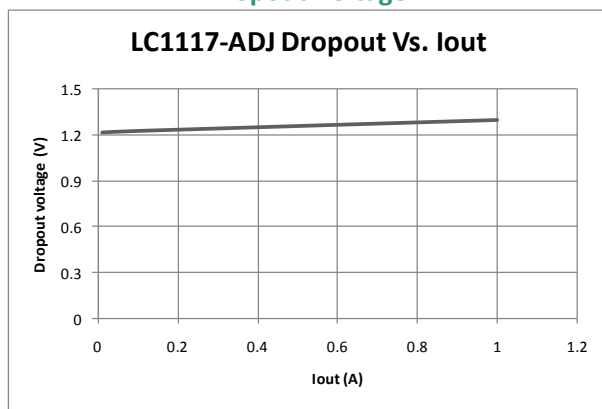

Thermal performance with OTP

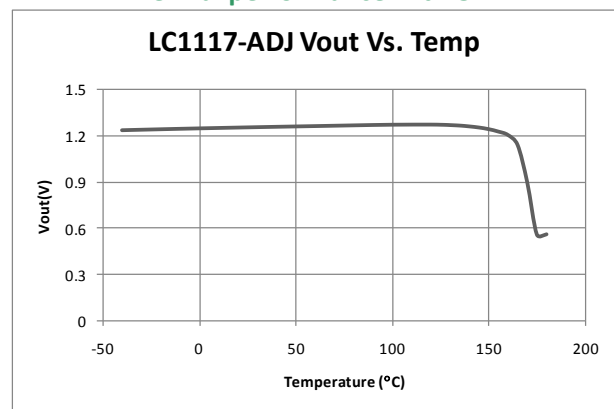

PACKAGE OUTLINE

Package	SOT-223	Devices per reel	2500	Unit	mm																																																																																																								
Package specification:																																																																																																													
		<p>COMMON DIMENSIONS (UNITS OF MEASURE=MILLIMETER)</p> <table border="1"> <thead> <tr> <th>SYMBOL</th> <th>MIN</th> <th>NOM</th> <th>MAX</th> </tr> </thead> <tbody> <tr><td>A</td><td>-</td><td>-</td><td>1.80</td></tr> <tr><td>A1</td><td>0.02</td><td>-</td><td>0.10</td></tr> <tr><td>A2</td><td>1.50</td><td>1.60</td><td>1.70</td></tr> <tr><td>A3</td><td>0.80</td><td>0.90</td><td>1.00</td></tr> <tr><td>b</td><td>0.67</td><td>-</td><td>0.80</td></tr> <tr><td>b1</td><td>0.66</td><td>0.71</td><td>0.76</td></tr> <tr><td>b2</td><td>2.96</td><td>-</td><td>3.09</td></tr> <tr><td>b3</td><td>2.95</td><td>3.00</td><td>3.05</td></tr> <tr><td>c</td><td>0.30</td><td>-</td><td>0.35</td></tr> <tr><td>c1</td><td>0.29</td><td>0.30</td><td>0.31</td></tr> <tr><td>D</td><td>6.48</td><td>6.53</td><td>6.58</td></tr> <tr><td>D1</td><td>6.55</td><td>6.60</td><td>6.65</td></tr> <tr><td>D2</td><td>-</td><td>-</td><td>7.05</td></tr> <tr><td>E</td><td>6.80</td><td>-</td><td>7.20</td></tr> <tr><td>E1</td><td>3.40</td><td>3.50</td><td>3.60</td></tr> <tr><td>E2</td><td>3.33</td><td>3.43</td><td>3.53</td></tr> <tr><td>e</td><td colspan="3">2.30BSC</td></tr> <tr><td>e1</td><td colspan="3">4.60BSC</td></tr> <tr><td>L</td><td>0.80</td><td>1.00</td><td>1.20</td></tr> <tr><td>L1</td><td colspan="3">1.75REF</td></tr> <tr><td>L2</td><td colspan="3">0.25BSC</td></tr> <tr><td>R</td><td>0.10</td><td>-</td><td>-</td></tr> <tr><td>R1</td><td>0.10</td><td>-</td><td>-</td></tr> <tr><td>θ</td><td>0°</td><td>-</td><td>8°</td></tr> <tr><td>θ 1</td><td>10°</td><td>12°</td><td>14°</td></tr> </tbody> </table> <p>NOTES: ALL DIMENSIONS REFER TO JEDEC STANDARD TO261-AA</p>				SYMBOL	MIN	NOM	MAX	A	-	-	1.80	A1	0.02	-	0.10	A2	1.50	1.60	1.70	A3	0.80	0.90	1.00	b	0.67	-	0.80	b1	0.66	0.71	0.76	b2	2.96	-	3.09	b3	2.95	3.00	3.05	c	0.30	-	0.35	c1	0.29	0.30	0.31	D	6.48	6.53	6.58	D1	6.55	6.60	6.65	D2	-	-	7.05	E	6.80	-	7.20	E1	3.40	3.50	3.60	E2	3.33	3.43	3.53	e	2.30BSC			e1	4.60BSC			L	0.80	1.00	1.20	L1	1.75REF			L2	0.25BSC			R	0.10	-	-	R1	0.10	-	-	θ	0°	-	8°	θ 1	10°	12°	14°
SYMBOL	MIN	NOM	MAX																																																																																																										
A	-	-	1.80																																																																																																										
A1	0.02	-	0.10																																																																																																										
A2	1.50	1.60	1.70																																																																																																										
A3	0.80	0.90	1.00																																																																																																										
b	0.67	-	0.80																																																																																																										
b1	0.66	0.71	0.76																																																																																																										
b2	2.96	-	3.09																																																																																																										
b3	2.95	3.00	3.05																																																																																																										
c	0.30	-	0.35																																																																																																										
c1	0.29	0.30	0.31																																																																																																										
D	6.48	6.53	6.58																																																																																																										
D1	6.55	6.60	6.65																																																																																																										
D2	-	-	7.05																																																																																																										
E	6.80	-	7.20																																																																																																										
E1	3.40	3.50	3.60																																																																																																										
E2	3.33	3.43	3.53																																																																																																										
e	2.30BSC																																																																																																												
e1	4.60BSC																																																																																																												
L	0.80	1.00	1.20																																																																																																										
L1	1.75REF																																																																																																												
L2	0.25BSC																																																																																																												
R	0.10	-	-																																																																																																										
R1	0.10	-	-																																																																																																										
θ	0°	-	8°																																																																																																										
θ 1	10°	12°	14°																																																																																																										
<p>SECTION C-C</p>		<p>SECTION D-D</p>																																																																																																											

Package	TO-252	Devices per reel	2500	Unit	mm																																																																																							
Package specification:																																																																																												
		<table border="1"> <thead> <tr> <th rowspan="2">SYMBOL</th> <th colspan="3">MILLIMETER</th> </tr> <tr> <th>MIN</th> <th>NOM</th> <th>MAX</th> </tr> </thead> <tbody> <tr><td>A1</td><td>0</td><td>-</td><td>0.10</td></tr> <tr><td>A2</td><td>2.2</td><td>2.3</td><td>2.4</td></tr> <tr><td>A3</td><td>1.02</td><td>1.067</td><td>1.12</td></tr> <tr><td>b</td><td>0.75</td><td>-</td><td>0.84</td></tr> <tr><td>b1</td><td>0.74</td><td>-</td><td>0.79</td></tr> <tr><td>c</td><td>0.49</td><td>-</td><td>0.57</td></tr> <tr><td>c1</td><td>0.48</td><td>0.508</td><td>0.52</td></tr> <tr><td>D</td><td>6.50</td><td>6.60</td><td>6.70</td></tr> <tr><td>D1</td><td colspan="3">5.334REF</td></tr> <tr><td>D2</td><td>4.70</td><td>4.826</td><td>4.92</td></tr> <tr><td>E</td><td>9.90</td><td>10.10</td><td>10.30</td></tr> <tr><td>E1</td><td>6.00</td><td>6.10</td><td>6.20</td></tr> <tr><td>E2</td><td colspan="3">5.30REF</td></tr> <tr><td>e</td><td colspan="3">2.286BSC</td></tr> <tr><td>L</td><td>1.40</td><td>1.50</td><td>1.60</td></tr> <tr><td>L2</td><td>0.90</td><td>-</td><td>1.25</td></tr> <tr><td>L3</td><td>0.60</td><td>0.80</td><td>1.00</td></tr> <tr><td>L4</td><td>1.70</td><td>1.80</td><td>1.90</td></tr> <tr><td>θ</td><td>0</td><td>-</td><td>8°</td></tr> <tr><td>L/F载体尺寸</td><td colspan="3">198×133</td></tr> </tbody> </table>				SYMBOL	MILLIMETER			MIN	NOM	MAX	A1	0	-	0.10	A2	2.2	2.3	2.4	A3	1.02	1.067	1.12	b	0.75	-	0.84	b1	0.74	-	0.79	c	0.49	-	0.57	c1	0.48	0.508	0.52	D	6.50	6.60	6.70	D1	5.334REF			D2	4.70	4.826	4.92	E	9.90	10.10	10.30	E1	6.00	6.10	6.20	E2	5.30REF			e	2.286BSC			L	1.40	1.50	1.60	L2	0.90	-	1.25	L3	0.60	0.80	1.00	L4	1.70	1.80	1.90	θ	0	-	8°	L/F载体尺寸	198×133		
SYMBOL	MILLIMETER																																																																																											
	MIN	NOM	MAX																																																																																									
A1	0	-	0.10																																																																																									
A2	2.2	2.3	2.4																																																																																									
A3	1.02	1.067	1.12																																																																																									
b	0.75	-	0.84																																																																																									
b1	0.74	-	0.79																																																																																									
c	0.49	-	0.57																																																																																									
c1	0.48	0.508	0.52																																																																																									
D	6.50	6.60	6.70																																																																																									
D1	5.334REF																																																																																											
D2	4.70	4.826	4.92																																																																																									
E	9.90	10.10	10.30																																																																																									
E1	6.00	6.10	6.20																																																																																									
E2	5.30REF																																																																																											
e	2.286BSC																																																																																											
L	1.40	1.50	1.60																																																																																									
L2	0.90	-	1.25																																																																																									
L3	0.60	0.80	1.00																																																																																									
L4	1.70	1.80	1.90																																																																																									
θ	0	-	8°																																																																																									
L/F载体尺寸	198×133																																																																																											
<p>SECTION A-A</p>		<p>SECTION B-B</p>																																																																																										

X-ON Electronics

Largest Supplier of Electrical and Electronic Components

Click to view similar products for [LDO Voltage Regulators](#) category:

Click to view products by [LEADCHIP](#) manufacturer:

Other Similar products are found below :

[M38D29FFHP#U1](#) [702103A](#) [717726C](#) [742457H](#) [MP20051DN-LF-Z](#) [R5F111PGGFB#30](#) [AP7363-SP-13](#) [NCP103AMX285TCG](#)
[NCV8664CST33T3G](#) [NCV8752AMX28TCG](#) [L9454](#) [AP7362-HA-7](#) [LX13043CLD](#) [TCR3DF185,LM\(CT](#) [TCR3DF24,LM\(CT](#)
[TCR3DF285,LM\(CT](#) [TCR3DF31,LM\(CT](#) [TCR3DF45,LM\(CT](#) [TLF4949EJ](#) [L9708](#) [L970813TR](#) [030014BB](#) [059985X](#) [EAN61387601](#)
[EAN61573601](#) [NCP121AMX173TCG](#) [NCP4687DH15T1G](#) [NCV8703MX30TCG](#) [701326R](#) [702087BB](#) [755078E](#) [TCR2EN28,LF\(S](#)
[LM1117DT-1.8/NO](#) [LT1086CM#TRPBF](#) [AZ1085S2-1.5TRE1](#) [MAX15101EWL+T](#) [NCV8170AXV250T2G](#) [SCD337BTG](#)
[TCR3DF27,LM\(CT](#) [TCR3DF19,LM\(CT](#) [TCR3DF125,LM\(CT](#) [TCR2EN18,LF\(S](#) [MAX15103EWL+T](#) [TS2937CZ-5.0 C0](#) [MAX8878EUK30-](#)
[T](#) [MAX663CPA](#) [NCV4269CPD50R2G](#) [NCV8716MT30TBG](#) [AZ1117IH-1.2TRG1](#) [MP2013GQ-P](#)