



# LC1463

## 300mA High PSRR, Fast Response Linear Regulator

### DESCRIPTION

LC1463 series is a group of positive voltage output, low power consumption, low dropout voltage regulator.

LC1463 can provide output value in the range of 1.0V~4.5V every 0.1V step. It also can be customized on command.

LC1463 includes high accuracy voltage reference, error amplifier, current limit circuit and output driver module with discharge capability.

LC1463 has excellent load and line transient response and good temperature characteristics, which can assure the stability of chip and power system. And it uses trimming technique to guarantee output voltage accuracy within  $\pm 2\%$ .

LC1463 is available in SOT-23-3, SOT23-5, SC-70-5 and DFN1x1-4 packages which are lead free.

### FEATURES

- Low Power Consumption: 35uA (Typ.)
- Low output noise (47uVRMS)
- Standby Mode: 0.1uA
- Low dropout Voltage: 300mV@300mA (Typ.)
- High Ripple Rejection: 70dB@10KHz (Typ.)
- Low Temperature Coefficient:  $\pm 100\text{ppm}/^\circ\text{C}$
- Excellent Line regulation: 0.05%/V
- Build-in chip enable and discharge circuit
- Output Voltage Range: 1.0V~4.5V (customized on command every 0.1V step)
- Highly Accurate:  $\pm 2\%$
- Output Current Limit

### APPLICATIONS

- Power source for cellular phones and various kind of PCSs
- Battery Powered equipment
- Power Management of MP3, PDA, DSC, Mouse, PS2 Games
- Reference Voltage Source
- Regulation after Switching Power

### TYPICAL APPLICATION

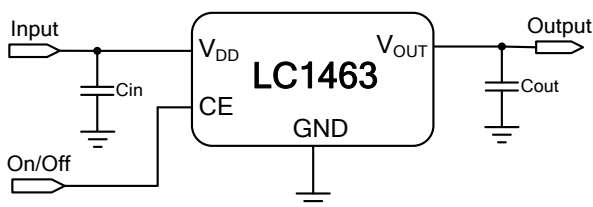

NOTE: Input capacitor ( $C_{in}=1\mu\text{F}$ ) and Output capacitor ( $C_{out}=1\mu\text{F}$ ) are recommended in all application circuit.

### ELECTRICAL CHARACTERISTICS

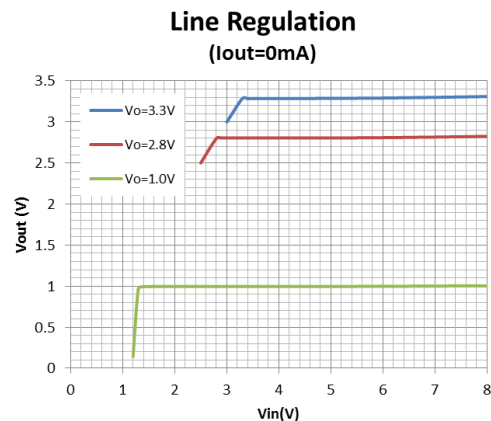

## ORDERING INFORMATION

LC1463 [1](#) [2](#) [3](#) [4](#)

Code	Description
<a href="#">1</a>	Temperature&RoHS: C:-40~85°C ,Pb Free RoHS Std. A: short circuit current >100mA
<a href="#">2</a>	Package type: A5:SC-70-5 B5A:SOT-23-5(A) B5B:SOT-23-5(B) B3: SOT23-3 KE:DFN1x1-4
<a href="#">3</a>	Packing type: TR:Tape&Reel (Standard)
<a href="#">4</a>	Output voltage: e.g. 15=1.5V 18=1.8V 45=4.5V

## MARKING DESCRIPTON

$\bar{F}$ : Product Code  
X: Output Voltage

Vout	Code	Vout	Code	Vout	Code
1.0V	0	2.3V	$\bar{3}$	3.6V	$\bar{6}$
1.1V	1	2.4V	$\bar{4}$	3.7V	$\bar{7}$
1.2V	2	2.5V	$\bar{5}$	3.8V	$\bar{8}$
1.3V	3	2.6V	$\bar{6}$	3.9V	$\bar{9}$
1.4V	4	2.7V	$\bar{7}$	4.0V	$\bar{0}$
1.5V	5	2.8V	$\bar{8}$	4.1V	$\bar{1}$
1.6V	6	2.9V	$\bar{9}$	4.2V	$\bar{2}$
1.7V	7	3.0V	$\bar{0}$	4.3V	$\bar{3}$
1.8V	8	3.1V	$\bar{1}$	4.4V	$\bar{4}$
1.9V	9	3.2V	$\bar{2}$	4.5V	$\bar{5}$
2.0V	$\bar{0}$	3.3V	$\bar{3}$		
2.1V	$\bar{1}$	3.4V	$\bar{4}$		
2.2V	$\bar{2}$	3.5V	$\bar{5}$		

Z: The Year of manufacturing, "1" stands for year 2011, "2" stands for year 2012, and "8" stands for year 2018.

Z: The week of manufacturing. "A" stands for week 1, "Z" stands for week 26, "A" stands for week 27, "Z" stands for week 52.

## PIN CONFIGURATION

Product Classification	LC1463CA5TR□□
$\bar{F}$ : Product Code	
X: Output Voltage	
ZZ: Date Code	
Product Classification	LC1463CB5ATR□□
$\bar{F}$ : Product Code	
X: Output Voltage	
ZZ: Date Code	
Product Classification	LC1463CB5BTR□□
$\bar{F}$ : Product Code	
X: Output Voltage	
ZZ: Date Code	
I: B type	
Product Classification	LC1463CB3TR□□
F: Product Code	
X: Output Voltage	
ZZ: Date Code	
Product Classification	LC1463CKETR□□
XX: Output Voltage	
Vss	Ground Pin
Vin	Supply Voltage Input
Vout	Output Voltage
CE	Chip Enable
NC	No Connection

## ABSOLUTE MAXIMUM RATING

Parameter		Value
Max Input Voltage		8V
Operating Junction Temperature(Tj)		125°C
Output Current		300mA
Ambient Temperature(Ta)		-40°C -85°C
Package Thermal Resistance ( $\theta_{JA}$ )	SOT-23-5	220°C / W
	SOT-23-3	220°C / W
Power Dissipation	SC70-5	250mW
	SOT-23-5	250mW
	SOT-23-3	250mW
	DFN1x1-4	600mW
Storage Temperature(Ts)		-40°C -150°C
Lead Temperature & Time		260°C,10S

**Note:**

- 1) Heat Sink Area of PCB for DFN1x1-4 is recommended at least 2.5mmx4mm.
- 2) Package Thermal Resistance value can be affected by PCB design, outside radiator, ambient airflow, operating power, it just shows for reference.
- 3) Exceed these limits to damage to the device.
- 4) Exposure to absolute maximum rating conditions may affect device reliability.

## RECOMMENDED WORK CONDITIONS

Item	Min	Recommended	Max.	Unit
Input Voltage Range	2		6	V
Ambient Temperature	-40		85	°C

## ELECTRICAL CHARACTERISTICS

(Test Conditions: Cin=1uF,Cout=1uF,TA=25°C, unless otherwise specified. )

LC1463, For Arbitrary Output Voltage

Symbol	Parameter	Conditions	Min	Typ	Max	Units
Vin	Input Voltage		2		6	V
Vout	Output Voltage	Vout>1.5V	Vin=Set Vout+1V	Vout x0.98	Vout X1.02	V
		Vout<=1.5V	1mA≤Iout≤30mA	Vout -0.03	Vout +0.03	
Iout (Max.)	Maximum Output Current	Vin-Vout=1V	300			mA
Vdrop <sup>1</sup>	Dropout Voltage, Vout≥2.8V	Iout=100mA		100	150	mV
		Iout=300mA		300	400	mV
$\frac{\Delta V_{out}}{\Delta V_{in} \cdot V_{out}}$	Line Regulation	Iout=40mA 2.8V≤Vin≤6V		0.05	0.2	%/V
$\frac{\Delta V_{out}}{\Delta I_{out}}$	Load Regulation	Vin=Set Vout+1V 1mA≤Iout≤300mA		50	80	mV
Iss	Supply Current	Vin=Set Vout+1V		35	80	uA
Istandby	Supply Current (Srandby)	Vin=Set Vout+1V Vce=GND		0.1	1.0	uA

# LC1463

$\frac{\Delta V_{out}}{\Delta T \cdot V_{out}}$	Output Voltage Temperature Coefficient	$I_{out}=30mA$		$\pm 100$		ppm/°C
PSRR	Ripple Rejection	F=1KHz, Ripple=0.5Vp-p Vin=Set Vout+1V		70		dB
Ilim	Current Limit		300			mA
Rpd	CE Pull down Resistance			500		KΩ
Rdischarge	Discharge Resistor	CE=0, Vout=3.0V		1.5K		ohm
Vceh	CE Input Voltage "H"		1.5		Vin	V
Vcel	CE Input Voltage "L"		0		0.25	V
en	Output Noise	BW=10Hz~100kHz		47		uVrms

**Note:**

$V_{drop} = V_{in1} - (V_{out2} * 0.98)$   $V_{out2}$  is the output voltage when  $V_{in} = V_{out1} + 1.0V$  and  $I_{out} = 300mA$ .

$V_{in1}$  is the input voltage at which the output voltage becomes 98% of  $V_{out1}$  after gradually decreasing the input voltage.

## BLOCK DIAGRAM

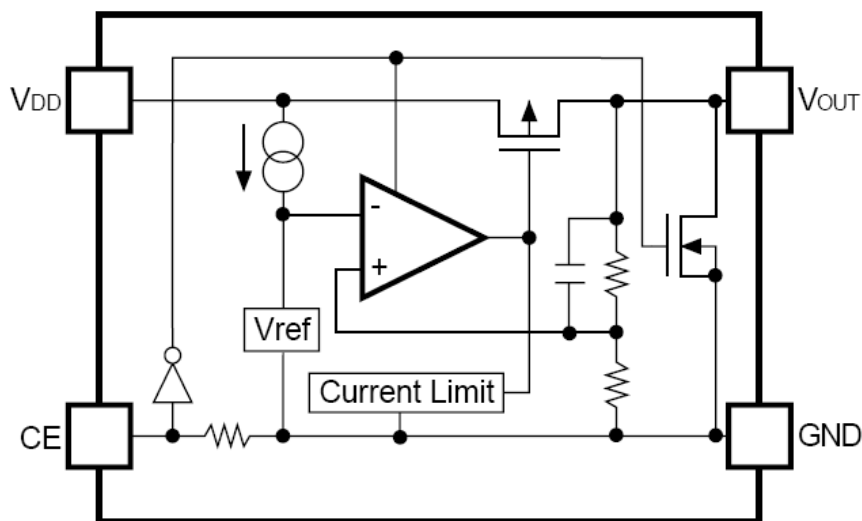

## EXPLANATION

LC1463 series is a group of positive voltage output, low noise, low power consumption, low dropout voltage regulator.

LC1463 can provide output value in the range of 1.0V~4.5V every 0.1V step. It also can be customized on command.

LC1463 includes high accuracy voltage reference, error amplifier, current limit circuit and output driver module.

LC1463 has excellent load and line transient response and good temperature characteristics, which can assure the stability of chip and power system. And it uses trimming technique to guarantee output voltage accuracy within  $\pm 2\%$ .

## TYPICAL PERFORMANCE CHARACTERISTICS

**Load Regulation**  
( $V_{out}=3.3V$ )

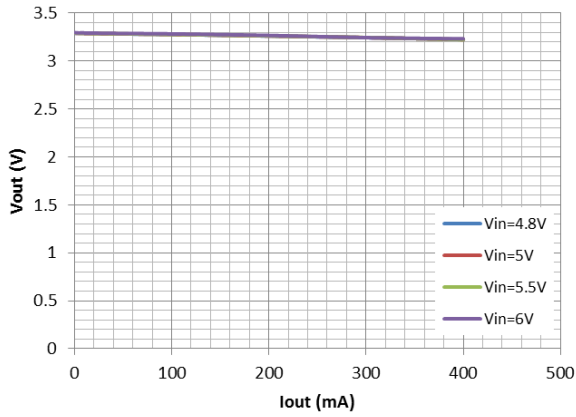

**Load Regulation**  
( $V_{out}=2.8V$ )

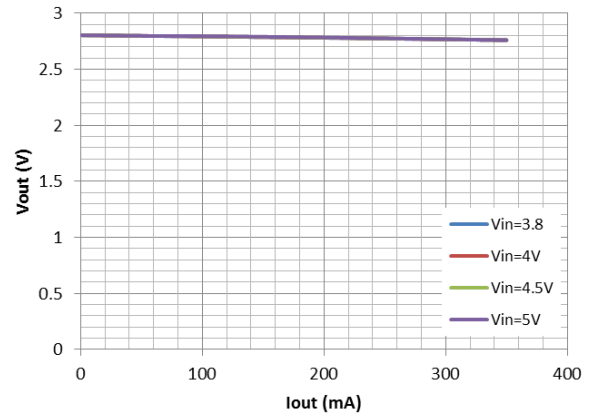

**Load Regulation**  
( $V_{out}=1.0V$ )

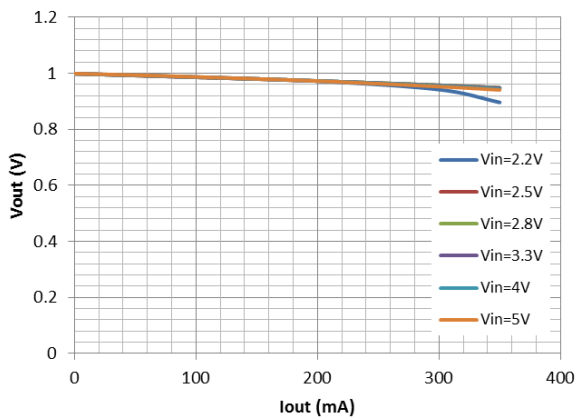

**Line Regulation**  
( $I_{out}=0mA$ )

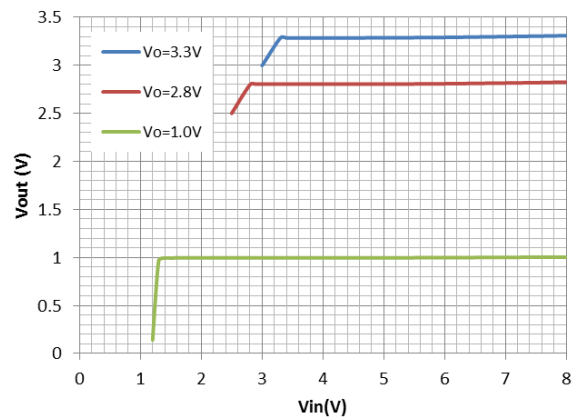

**Quiescent Current**  
( $I_{out}=0mA$  and  $C_E=high$ )

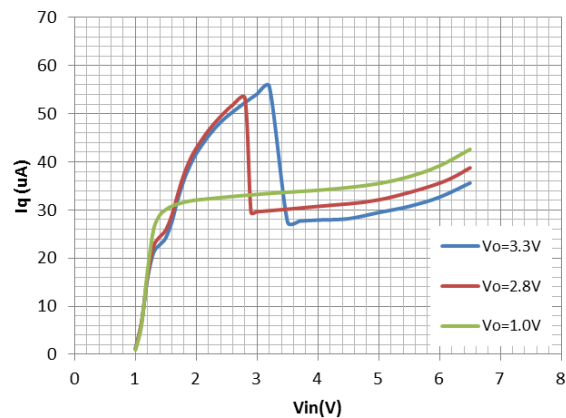

**Dropout Voltage**  
( $V_{out}=3.3V$ )

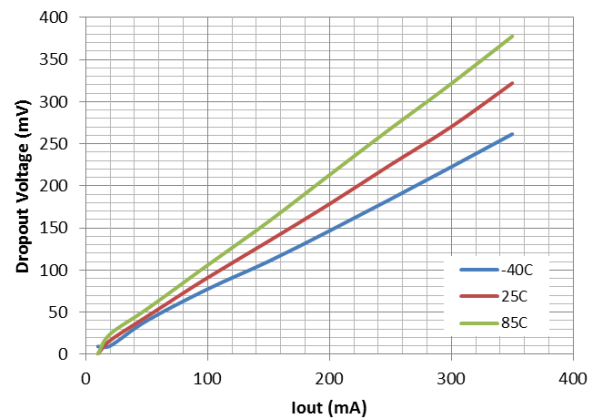

## Dropout Voltage

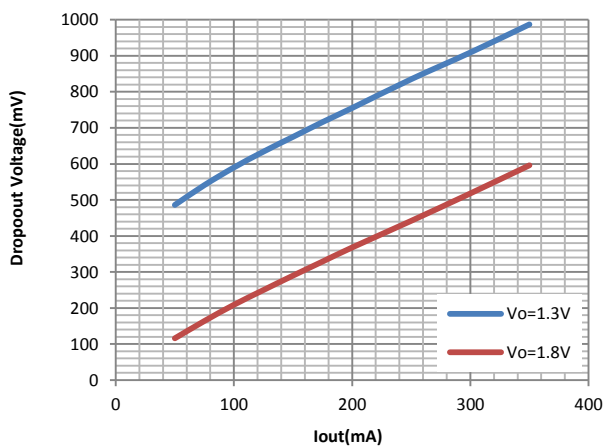

## Vout Temperature Coefficient (Vout=3.3V)

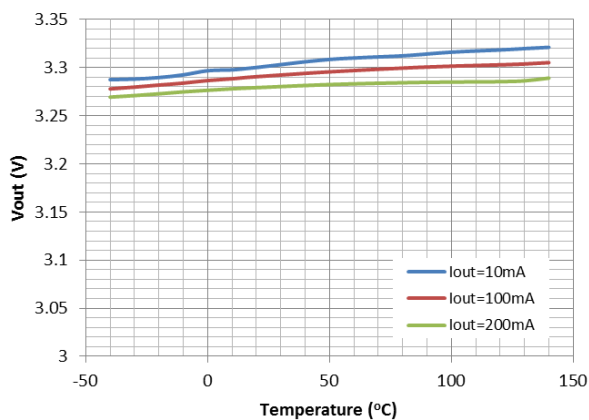

## PSRR

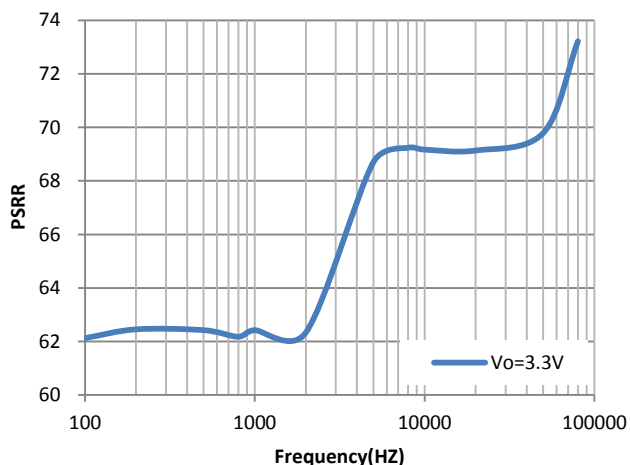

## CE Chip Enable Response

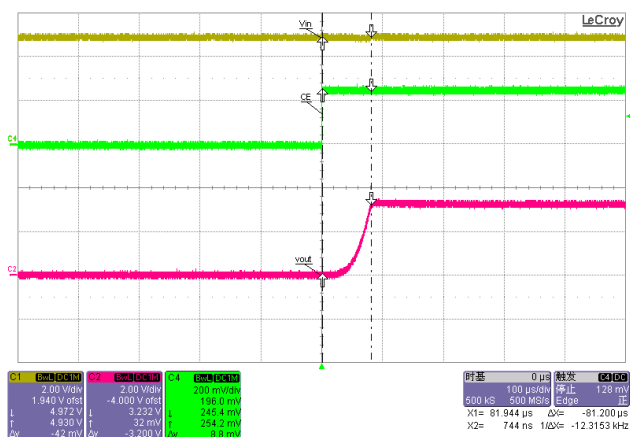

## Line Transient Response

Vout=3.3V, Iout=20mA  
(brown: Vin; Red: Vout)

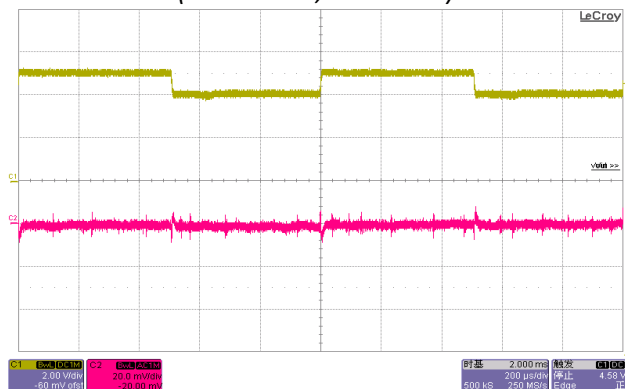

## Load Transient Response

Vin=5V, Vout=3.3V, Iout=1-100mA  
(Green: Iout; Red: Vout)

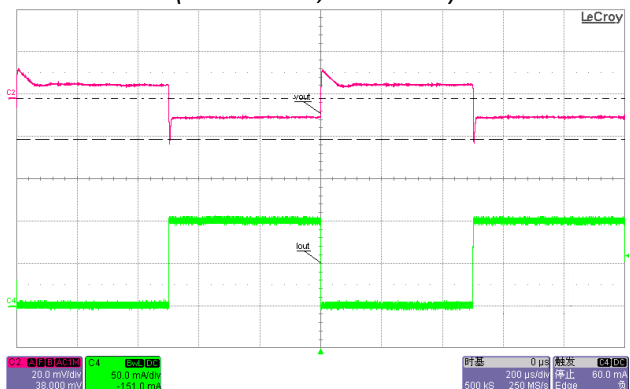

## PACKAGE OUTLINE

Package	SC70-5	Devices per reel	3000Pcs	Unit	mm
<p>Package dimension:</p>					
Package	SOT-23-5	Devices per reel	3000Pcs	Unit	mm
<p>Package Dimension:</p>					

Package	SOT-23-3	Devices per reel	3000Pcs	Unit	mm
---------	----------	------------------	---------	------	----

Package Dimension:

Top View Dimensions:  
 Total width:  $2.9 \pm 0.2$   
 Pin 3 width:  $0.4 \pm 0.1$   
 Pin 1 width:  $0.95$   
 Pin 2 width:  $0.95$   
 Pin 1-2 spacing:  $1.9 \pm 0.2$   
 Body width:  $1.6 \pm 0.2$   
 Total height:  $2.8 \pm 0.3$

Side View Dimensions:  
 Max. height:  $1.4 \text{ MAX.}$   
 Pin 3 height:  $1.1^{+0.2}_{-0.1}$   
 Pin 3 width:  $0.8$   
 Pin 3 chamfer:  $0 \text{ to } 0.1$   
 Pin 1-2 height:  $0.2 \text{ MIN.}$   
 Pin 1-2 width:  $0.16^{+0.1}_{-0.06}$

Package	DFN1x1-4	Devices per reel	5000Pcs	Unit	mm
---------	----------	------------------	---------	------	----

Package dimension:

TOP VIEW:  
 Width:  $1.000 \pm 0.050$   
 Height:  $1.000 \pm 0.050$   
 Marking: 4L STSLP (1x1mm)  
 PIN 1# DOT BY MARKING

BOTTOM VIEW:  
 Pin 1 width:  $0.500 \pm 0.050$  Exp. DAP  
 Pin 2 width:  $0.500 \pm 0.050$  Exp. DAP  
 Pin 3 width:  $0.625$  Bsc  
 Pin 4 width:  $0.225 \pm 0.050$   
 Pin 1-4 spacing:  $0.250 \pm 0.050$   
 PIN #1 IDENTIFICATION CHAMFER R0.075mm  
 Chamfer: 4-C0.18

NOTE:  
 1). 'A' DIMENSION AS BELOW TABLE

A	STSLP	
	MAX.	0.600
NOM.	0.550	
MIN.	0.500	

SIDE VIEW:  
 Pin 1-4 height:  $0.000 - 0.050$   
 Pin 1-4 width:  $0.152 \text{ Ref.}$



## X-ON Electronics

Largest Supplier of Electrical and Electronic Components

*Click to view similar products for [LDO Voltage Regulators](#) category:*

*Click to view products by [LEADCHIP](#) manufacturer:*

Other Similar products are found below :

[M38D29FFHP#U1](#) [702103A](#) [717726C](#) [742457H](#) [MP20051DN-LF-Z](#) [R5F111PGGFB#30](#) [AP7363-SP-13](#) [NCP103AMX285TCG](#)  
[NCV8664CST33T3G](#) [NCV8752AMX28TCG](#) [L9454](#) [AP7362-HA-7](#) [LX13043CLD](#) [TCR3DF185,LM\(CT](#) [TCR3DF24,LM\(CT](#)  
[TCR3DF285,LM\(CT](#) [TCR3DF31,LM\(CT](#) [TCR3DF45,LM\(CT](#) [TLF4949EJ](#) [L9708](#) [L970813TR](#) [030014BB](#) [059985X](#) [EAN61387601](#)  
[EAN61573601](#) [NCP121AMX173TCG](#) [NCP4687DH15T1G](#) [NCV8703MX30TCG](#) [701326R](#) [702087BB](#) [755078E](#) [TCR2EN28,LF\(S](#)  
[LM1117DT-1.8/NO](#) [LT1086CM#TRPBF](#) [AZ1085S2-1.5TRE1](#) [MAX15101EWL+T](#) [NCV8170AXV250T2G](#) [SCD337BTG](#)  
[TCR3DF27,LM\(CT](#) [TCR3DF19,LM\(CT](#) [TCR3DF125,LM\(CT](#) [TCR2EN18,LF\(S](#) [MAX15103EWL+T](#) [TS2937CZ-5.0 C0](#) [MAX8878EUK30-](#)  
[T](#) [MAX663CPA](#) [NCV4269CPD50R2G](#) [NCV8716MT30TBG](#) [AZ1117IH-1.2TRG1](#) [MP2013GQ-P](#)