



# LC1463

## 300mA High PSRR, Fast Response Linear Regulator

### DESCRIPTION

LC1463 series is a group of positive voltage output, low power consumption, low dropout voltage regulator.

LC1463 can provide output value in the range of 1.0V~4.5V every 0.1V step. It also can be customized on command.

LC1463 includes high accuracy voltage reference, error amplifier, current limit circuit and output driver module with discharge capability.

LC1463 has excellent load and line transient response and good temperature characteristics, which can assure the stability of chip and power system. And it uses trimming technique to guarantee output voltage accuracy within  $\pm 2\%$ .

LC1463 is available in SOT-23-3, SOT23-5, SC-70-5 and DFN1x1-4 packages which are lead free.

### FEATURES

- Low Power Consumption: 35 $\mu$ A (Typ.)
- Low output noise (47 $\mu$ V<sub>RMS</sub>)
- Standby Mode: 0.1 $\mu$ A
- Low dropout Voltage: 300mV@300mA (Typ.)
- High Ripple Rejection: 70dB@10KHz (Typ.)
- Low Temperature Coefficient:  $\pm 100$ ppm/ $^{\circ}$ C
- Excellent Line regulation: 0.05%/V
- Build-in chip enable and discharge circuit
- Output Voltage Range: 1.0V~4.5V (customized on command every 0.1V step)
- Highly Accurate:  $\pm 2\%$
- Output Current Limit

### APPLICATIONS

- Power source for cellular phones and various kind of PCSs
- Battery Powered equipment
- Power Management of MP3, PDA, DSC, Mouse, PS2 Games
- Reference Voltage Source
- Regulation after Switching Power

### TYPICAL APPLICATION

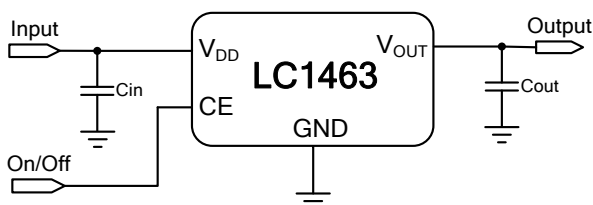

NOTE: Input capacitor ( $C_{in}=1\mu F$ ) and Output capacitor ( $C_{out}=1\mu F$ ) are recommended in all application circuit.

### ELECTRICAL CHARACTERISTICS

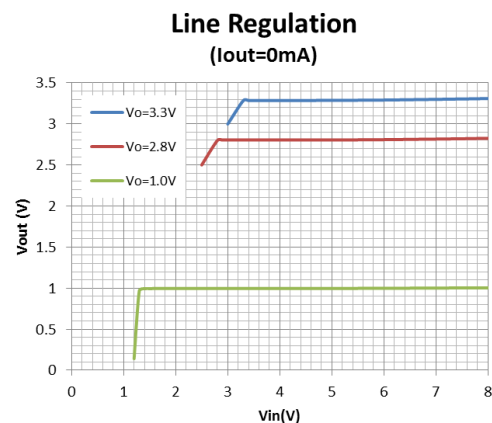

## ORDERING INFORMATION

LC1463 [1](#) [2](#) [3](#) [4](#)

| Code              | Description   |
|-------------------|---|
| <a href="#">1</a> | Temperature&RoHS:<br>C:-40~85°C ,Pb Free RoHS Std.<br>A: short circuit current >100mA           |
| <a href="#">2</a> | Package type:<br>A5:SC-70-5<br>B5A:SOT-23-5(A)<br>B5B:SOT-23-5(B)<br>B3: SOT23-3<br>KE:DFN1x1-4 |
| <a href="#">3</a> | Packing type:<br>TR:Tape&Reel (Standard)  |
| <a href="#">4</a> | Output voltage:<br>e.g. 15=1.5V<br>18=1.8V<br>45=4.5V   |

## MARKING DESCRIPTON

$\bar{F}$ : Product Code  
X: Output Voltage

| Vout | Code      | Vout | Code      | Vout | Code      |
|------|-----------|------|-----------|------|-----------|
| 1.0V | 0         | 2.3V | $\bar{3}$ | 3.6V | $\bar{6}$ |
| 1.1V | 1         | 2.4V | $\bar{4}$ | 3.7V | $\bar{7}$ |
| 1.2V | 2         | 2.5V | $\bar{5}$ | 3.8V | $\bar{8}$ |
| 1.3V | 3         | 2.6V | $\bar{6}$ | 3.9V | $\bar{9}$ |
| 1.4V | 4         | 2.7V | $\bar{7}$ | 4.0V | $\bar{0}$ |
| 1.5V | 5         | 2.8V | $\bar{8}$ | 4.1V | $\bar{1}$ |
| 1.6V | 6         | 2.9V | $\bar{9}$ | 4.2V | $\bar{2}$ |
| 1.7V | 7         | 3.0V | $\bar{0}$ | 4.3V | $\bar{3}$ |
| 1.8V | 8         | 3.1V | $\bar{1}$ | 4.4V | $\bar{4}$ |
| 1.9V | 9         | 3.2V | $\bar{2}$ | 4.5V | $\bar{5}$ |
| 2.0V | $\bar{0}$ | 3.3V | $\bar{3}$ |      |           |
| 2.1V | $\bar{1}$ | 3.4V | $\bar{4}$ |      |           |
| 2.2V | $\bar{2}$ | 3.5V | $\bar{5}$ |      |           |

Z: The Year of manufacturing, "1" stands for year 2011, "2" stands for year 2012, and "8" stands for year 2018.

Z: The week of manufacturing. "A" stands for week 1, "Z" stands for week 26, "A" stands for week 27, "Z" stands for week 52.

## PIN CONFIGURATION

|                          |                      |
|--------------------------|----------------------|
| Product Classification   | LC1463CA5TR□□        |
| $\bar{F}$ : Product Code |                      |
| X: Output Voltage        |                      |
| ZZ: Date Code            |                      |
| Product Classification   | LC1463CB5ATR□□       |
| $\bar{F}$ : Product Code |                      |
| X: Output Voltage        |                      |
| ZZ: Date Code            |                      |
| Product Classification   | LC1463CB5BTR□□       |
| $\bar{F}$ : Product Code |                      |
| X: Output Voltage        |                      |
| ZZ: Date Code            |                      |
| I: B type                |                      |
| Product Classification   | LC1463CB3TR□□        |
| F: Product Code          |                      |
| X: Output Voltage        |                      |
| ZZ: Date Code            |                      |
| Product Classification   | LC1463CKETR□□        |
| XX: Output Voltage       |                      |
| Vss                      | Ground Pin           |
| Vin                      | Supply Voltage Input |
| Vout                     | Output Voltage       |
| CE                       | Chip Enable          |
| NC                       | No Connection        |

## ABSOLUTE MAXIMUM RATING

| Parameter                                    |          | Value        |
|--|----------|--------------|
| Max Input Voltage                            |          | 8V           |
| Operating Junction Temperature(Tj)           |          | 125°C        |
| Output Current                               |          | 300mA        |
| Ambient Temperature(Ta)                      |          | -40°C –85°C  |
| Package Thermal Resistance ( $\theta_{JA}$ ) | SOT-23-5 | 220°C / W    |
|  | SOT-23-3 | 220°C / W    |
| Power Dissipation                            | SC70-5   | 250mW        |
|  | SOT-23-5 | 250mW        |
|  | SOT-23-3 | 250mW        |
|  | DFN1x1-4 | 600mW        |
| Storage Temperature(Ts)                      |          | -40°C -150°C |
| Lead Temperature & Time                      |          | 260°C,10S    |

**Note:**

- 1) Heat Sink Area of PCB for DFN1x1-4 is recommended at least 2.5mmx4mm.
- 2) Package Thermal Resistance value can be affected by PCB design, outside radiator, ambient airflow, operating power, it just shows for reference.
- 3) Exceed these limits to damage to the device.
- 4) Exposure to absolute maximum rating conditions may affect device reliability.

## RECOMMENDED WORK CONDITIONS

| Item                | Min | Recommended | Max. | Unit |
|---------------------|-----|-------------|------|------|
| Input Voltage Range | 2   |             | 6    | V    |
| Ambient Temperature | -40 |             | 85   | °C   |

## ELECTRICAL CHARACTERISTICS

(Test Conditions:  $C_{in}=1\mu F, C_{out}=1\mu F, T_A=25^\circ C$ , unless otherwise specified. )

LC1463, For Arbitrary Output Voltage

| Symbol   | Parameter                            | Conditions   | Min                   | Typ       | Max                   | Units |
|--|--------------------------------------|--|-----------------------|-----------|-----------------------|-------|
| $V_{in}$   | Input Voltage                        |  | 2                     |           | 6                     | V     |
| $V_{out}$  | Output Voltage                       | $V_{out}>1.5V$   | $V_{out} \times 0.98$ | $V_{out}$ | $V_{out} \times 1.02$ | V     |
|  |                                      | $V_{out} \leq 1.5V$  | $V_{out} - 0.03$      |           | $V_{out} + 0.03$      |       |
| $I_{out} (Max.)$                                     | Maximum Output Current               | $V_{in}-V_{out}=1V$  | 300                   |           |                       | mA    |
| $V_{drop}^1$   | Dropout Voltage, $V_{out} \geq 2.8V$ | $I_{out}=100mA$  |                       | 100       | 150                   | mV    |
|  |                                      | $I_{out}=300mA$  |                       | 300       | 400                   | mV    |
| $\frac{\Delta V_{out}}{\Delta V_{in} \cdot V_{out}}$ | Line Regulation                      | $I_{out}=40mA$<br>$2.8V \leq V_{in} \leq 6V$                   |                       | 0.05      | 0.2                   | %/V   |
| $\frac{\Delta V_{out}}{\Delta I_{out}}$              | Load Regulation                      | $V_{in} = Set \ V_{out} + 1V$<br>$1mA \leq I_{out} \leq 300mA$ |                       | 50        | 80                    | mV    |
| $I_{ss}$   | Supply Current                       | $V_{in} = Set \ V_{out} + 1V$                                  |                       | 35        | 80                    | uA    |
| $I_{standby}$  | Supply Current (Standby)             | $V_{in} = Set \ V_{out} + 1V$<br>$V_{ce} = GND$                |                       | 0.1       | 1.0                   | uA    |

# LC1463

| $\frac{\Delta V_{out}}{\Delta T \cdot V_{out}}$ | Output Voltage Temperature Coefficient | $I_{out}=30mA$                            |     | $\pm 100$ |      | ppm/°C |
|---|--|---|-----|-----------|------|--------|
| PSRR  | Ripple Rejection                       | F=1KHz, Ripple=0.5Vp-p<br>Vin=Set Vout+1V |     | 70        |      | dB     |
| Ilim  | Current Limit                          |   | 300 |           |      | mA     |
| Rpd   | CE Pull down Resistance                |   |     | 500       |      | KΩ     |
| Rdischarge                                      | Discharge Resistor                     | CE=0, Vout=3.0V                           |     | 1.5K      |      | ohm    |
| Vceh  | CE Input Voltage "H"                   |   | 1.5 |           | Vin  | V      |
| Vcel  | CE Input Voltage "L"                   |   | 0   |           | 0.25 | V      |
| en  | Output Noise                           | BW=10Hz~100kHz                            |     | 47        |      | uVrms  |

**Note:**

$V_{drop} = V_{in1} - (V_{out2} * 0.98)$   $V_{out2}$  is the output voltage when  $V_{in} = V_{out1} + 1.0V$  and  $I_{out} = 30mA$ .

$V_{in1}$  is the input voltage at which the output voltage becomes 98% of  $V_{out1}$  after gradually decreasing the input voltage.

## BLOCK DIAGRAM

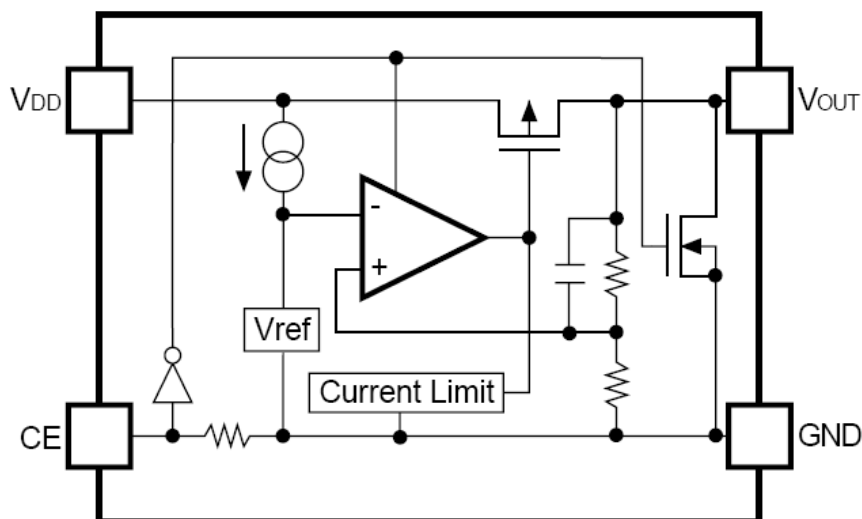

## EXPLANATION

LC1463 series is a group of positive voltage output, low noise, low power consumption, low dropout voltage regulator.

LC1463 can provide output value in the range of 1.0V~4.5V every 0.1V step. It also can be customized on command.

LC1463 includes high accuracy voltage reference, error amplifier, current limit circuit and output driver module.

LC1463 has excellent load and line transient response and good temperature characteristics, which can assure the stability of chip and power system. And it uses trimming technique to guarantee output voltage accuracy within  $\pm 2\%$ .

## TYPICAL PERFORMANCE CHARACTERISTICS

**Load Regulation**  
( $V_{out}=3.3V$ )

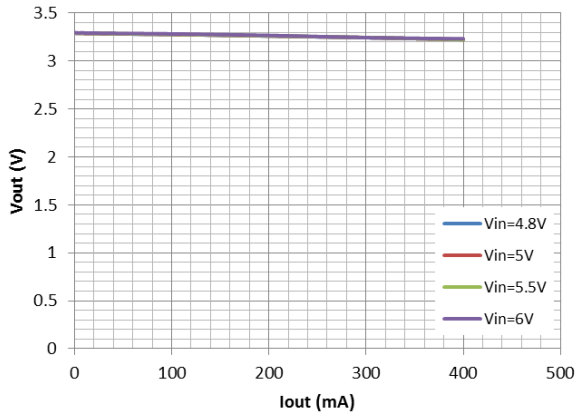

**Load Regulation**  
( $V_{out}=2.8V$ )

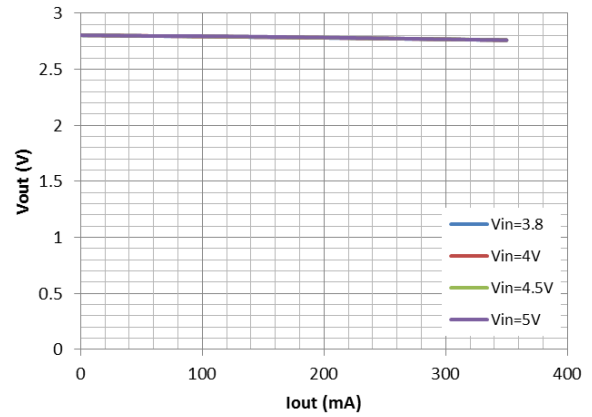

**Load Regulation**  
( $V_{out}=1.0V$ )

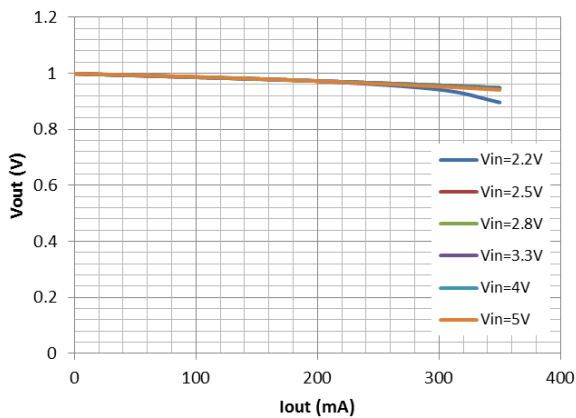

**Line Regulation**  
( $I_{out}=0mA$ )

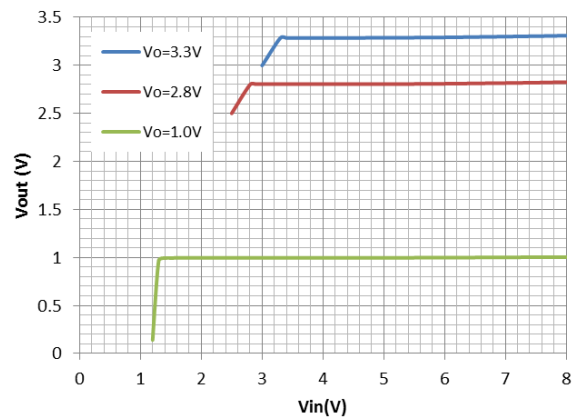

**Quiescent Current**  
( $I_{out}=0mA$  and  $C_E=high$ )

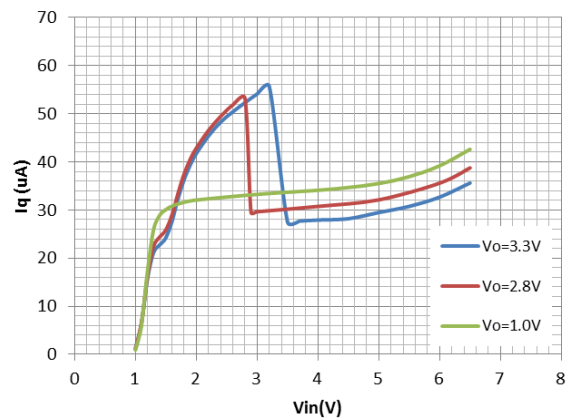

**Dropout Voltage**  
( $V_{out}=3.3V$ )

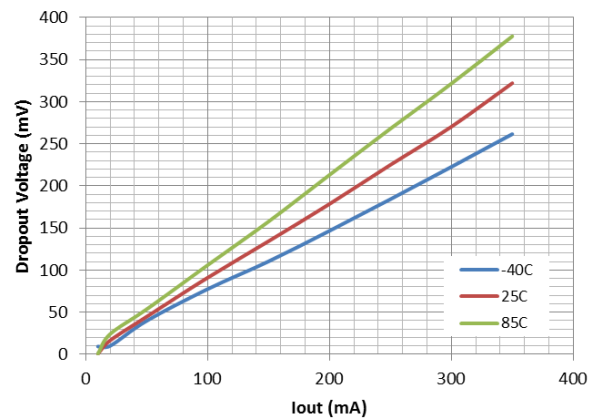

## Dropout Voltage

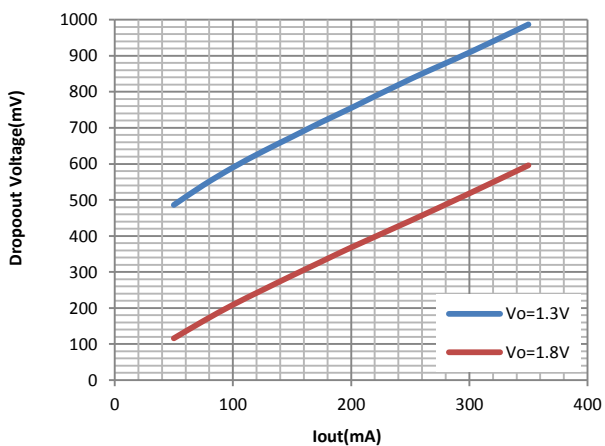

## Vout Temperature Coefficient (Vout=3.3V)

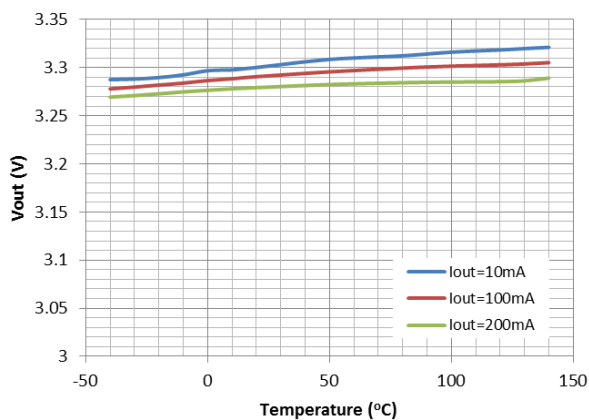

## PSRR

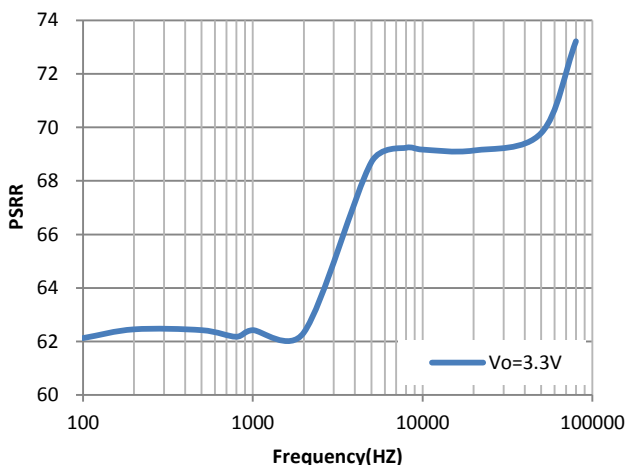

## CE Chip Enable Response

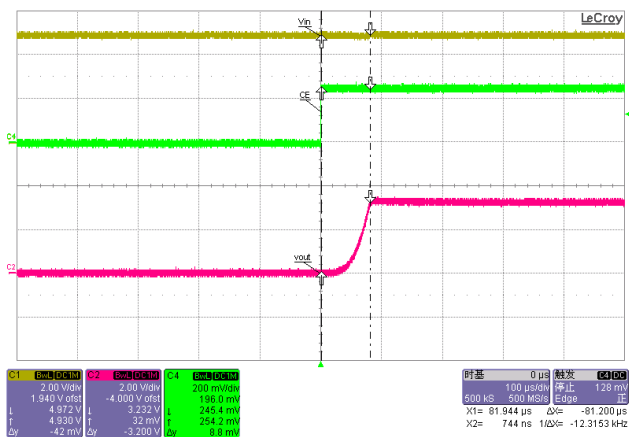

## Line Transient Response

Vout=3.3V, Iout=20mA  
(brown: Vin; Red: Vout)

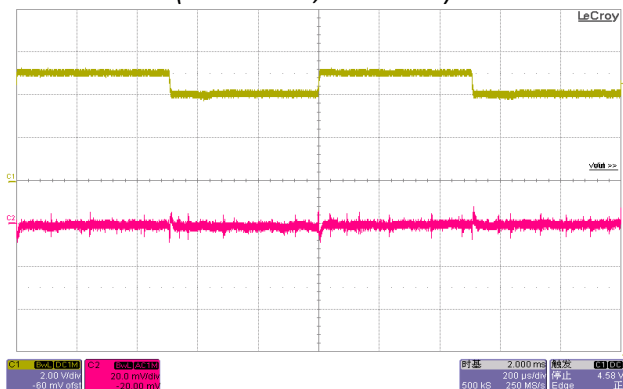

## Load Transient Response

Vin=5V, Vout=3.3V, Iout=1-100mA  
(Green: Iout; Red: Vout)

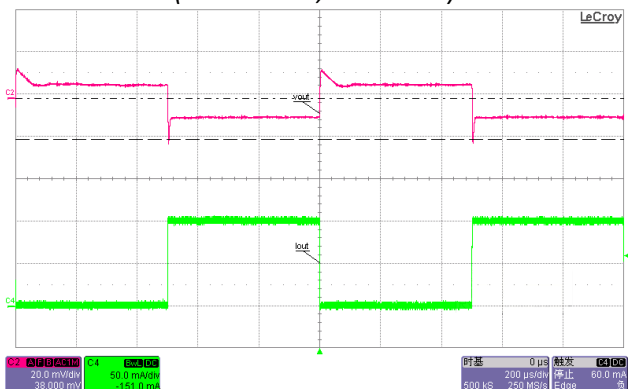

## PACKAGE OUTLINE

| Package                   | SC70-5   | Devices per reel | 3000Pcs | Unit | mm |
|---------------------------|----------|------------------|---------|------|----|
| <p>Package dimension:</p> |          |                  |         |      |    |
| Package                   | SOT-23-5 | Devices per reel | 3000Pcs | Unit | mm |
| <p>Package Dimension:</p> |          |                  |         |      |    |

|         |          |                  |         |      |    |
|---------|----------|------------------|---------|------|----|
| Package | SOT-23-3 | Devices per reel | 3000Pcs | Unit | mm |
|---------|----------|------------------|---------|------|----|

Package Dimension:

|         |          |                  |         |      |    |
|---------|----------|------------------|---------|------|----|
| Package | DFN1x1-4 | Devices per reel | 5000Pcs | Unit | mm |
|---------|----------|------------------|---------|------|----|

Package dimension:

NOTE:

1). ' A ' DIMENSION AS BELOW TABLE

| A | MAX. | STSLP |
|---|------|-------|
|   | NOM. | 0.600 |
|   | MIN. | 0.550 |



## X-ON Electronics

Largest Supplier of Electrical and Electronic Components

*Click to view similar products for [LDO Voltage Regulators](#) category:*

*Click to view products by [LEADCHIP](#) manufacturer:*

Other Similar products are found below :

[M38D29FFHP#U1](#) [702103A](#) [717726C](#) [742457H](#) [MP20051DN-LF-Z](#) [R5F111PGGFB#30](#) [AP7363-SP-13](#) [NCP103AMX285TCG](#)  
[NCV8664CST33T3G](#) [NCV8752AMX28TCG](#) [L9454](#) [AP7362-HA-7](#) [LX13043CLD](#) [TCR3DF185,LM\(CT](#) [TCR3DF24,LM\(CT](#)  
[TCR3DF285,LM\(CT](#) [TCR3DF31,LM\(CT](#) [TCR3DF45,LM\(CT](#) [TLF4949EJ](#) [L9708](#) [L970813TR](#) [030014BB](#) [059985X](#) [EAN61387601](#)  
[EAN61573601](#) [NCP121AMX173TCG](#) [NCP4687DH15T1G](#) [NCV8703MX30TCG](#) [701326R](#) [702087BB](#) [755078E](#) [TCR2EN28,LF\(S](#)  
[LM1117DT-1.8/NO](#) [LT1086CM#TRPBF](#) [AZ1085S2-1.5TRE1](#) [MAX15101EWL+T](#) [NCV8170AXV250T2G](#) [SCD337BTG](#)  
[TCR3DF27,LM\(CT](#) [TCR3DF19,LM\(CT](#) [TCR3DF125,LM\(CT](#) [TCR2EN18,LF\(S](#) [MAX15103EWL+T](#) [TS2937CZ-5.0 C0](#) [MAX8878EUK30-](#)  
[T](#) [MAX663CPA](#) [NCV4269CPD50R2G](#) [NCV8716MT30TBG](#) [AZ1117IH-1.2TRG1](#) [MP2013GQ-P](#)