



LC3500

0.9V startup, 1MHz, 300mA Iout, Low Iq, Synchronous Boost converter

DESCRIPTION

The LC3500 is a step-up converter that provides a boosted output voltage from a low voltage source. Because of its proprietary design, it starts up at a very low input voltage down to 0.9V, and only consumes 15uA at standby, making it an ideal choice for single cell alkaline/NiMH battery operations.

A switching frequency of 1MHz minimizes solution footprint by allowing the use of tiny, low profile inductors and ceramic capacitors. The current mode PWM design is internally compensated, reducing external parts count.

LC3500 is available in SOT23-3, SOT23-5 and SOT89-3 Packages.

FEATURES

- Efficiency up to 95%@Vin=2.7V, Vout=3.3V
- Typical 15uA standby current
- 1MHz Switching Frequency allows small inductor and output cap
- Input boost-strapping allows using small or no input cap
- Low Vin Start-up Voltage down to 0.9V Ideal for Single Alkaline Cell operations
- Maximum Output Current up to 300mA
- Low Noise PWM control
- Internally Compensated Current Mode Control
- Internal Synchronous Rectifier
- Available in SOT23-3, SOT23-5 and SOT89-3

APPLICATIONS

- One to Three Cell Battery Operated Devices
- Medical Instruments
- Bluetooth Headsets
- Flash-Based MP3 Players
- Noise Canceling Headphones

TYPICAL APPLICATION

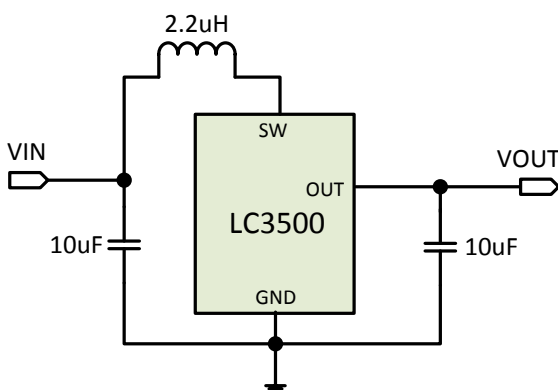

PIN OUT & MARKING

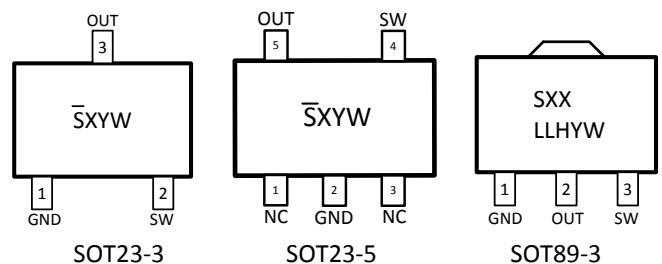

\bar{S} : Product Code
X: Output Voltage
YW: Date code

S: Product Code
XX: Output Voltage
LL: LOT No.
H: FAB Code
YW: Date code

Output Voltage Code X:

VOUT	Code	VOUT	Code
1.8V	8	3.0V	<u>0</u>
2.5V	$\bar{5}$	3.3V	<u>3</u>
2.7V	$\bar{7}$	3.6V	<u>6</u>
2.8V	$\bar{8}$		

ORDERING INFORMATION

PART No.	PACKAGE	Tape&Reel
LC3500CB3TR□□	SOT23-3	3000/Reel
LC3500CB5TR□□	SOT23-5	3000/Reel
LC3500CC3TR□□	SOT89-3	1000/Reel

Note: □□ stands for output voltage.

ABSOLUTE MAXIMUM RATING

Parameter	Value	
SW Voltage	-0.3 ~ 6V	
OUT Voltage	-0.3 ~ 6V	
Max Operating Junction Temperature(Tj)	125°C	
Maximum Power Dissipation	SOT23-3	450mW
	SOT23-5	450mW
	SOT89-3	500mW
Ambient Temperature(Ta)	-40°C – 85°C	
Storage Temperature(Ts)	-55°C - 150°C	
Lead Temperature & Time	260°C, 10S	

Note: Exceed these limits to damage to the device.

Exposure to absolute maximum rating conditions may affect device reliability.

ELECTRICAL CHARACTERISTICS

(T_A=25°C)

Symbol	Parameter	Conditions	Min	Typ	Max	Unit
V _{in}	Input Voltage Range		0.9		5	V
V _{start}	Startup Voltage	I _{out} = 1mA		0.9		V
V _{hold}	Hold Voltage	I _{out} = 50mA		0.5	0.7	V
V _{out}	Output Voltage Range		1.8		3.6	V
	Output voltage accuracy	I _{out} = 0mA		2		%
	Line regulation	I _{out} = 50mA		0.1	0.2	%/V
	Load regulation	I _{out} = 0~300mA		1	2	%
F _{soc}	Switching Frequency	V _{out} =0.95V _o , No inductor	0.7	1	1.4	MHz
	Max Duty cycle	V _{out} =0.95V _o , No inductor	85	90	95	%
I _q	Quiescent Current at V _{out}	V _{out} =1.05*V _o	5	8	15	uA
	Supply current at V _{in}	I _{out} = 0mA			20	uA
	Efficiency	I _{out} = 100mA	85			%
R _{dsonP}	PMOS R _{dson}	I _{sw} =100mA		400	600	mohm
R _{dsonN}	NMOS R _{dson}	I _{sw} =100mA		200	300	mohm
I _{swlk}	SW Leakage Current	V _{out} =3.6V, V _{sw} =0 or 5.2V			1	uA

PIN DESCRIPTION

PIN #			NAME	DESCRIPTION
SOT23-3	SOT23-5	SOT89-3		
1	2	1	GND	Ground
2	4	3	SW	To connect inductor to VIN
3	5	2	OUT	Output voltage pin, with 10uF ceramic capacitor closely connected to GND
-	1, 3	-	NC	No Connection

ELECTRICAL PERFORMANCE

Tested under $C_{in}=C_{out}=10\mu F$, $L=2.2\mu H$, $T_A=25^\circ C$, unless otherwise specified

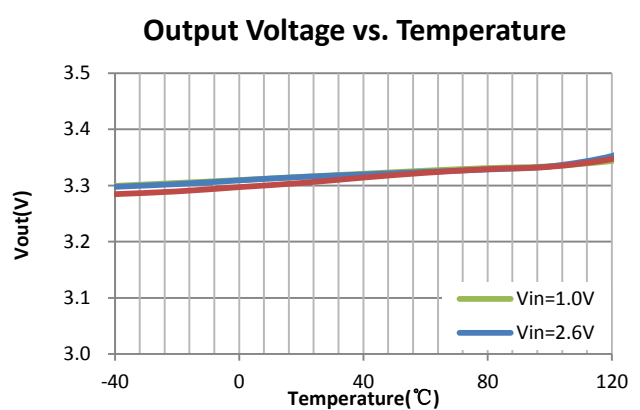
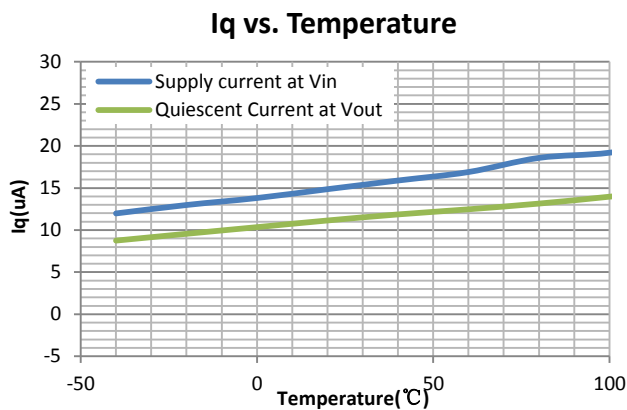
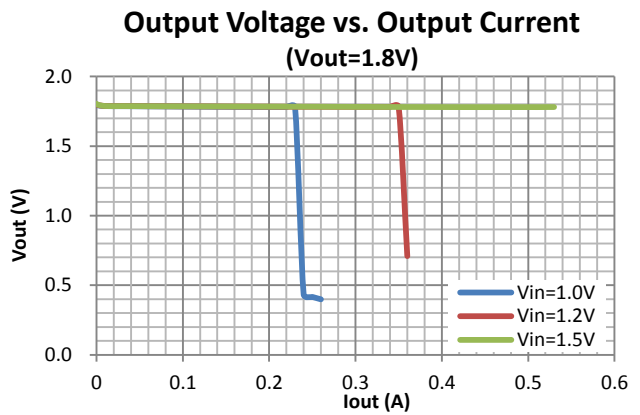
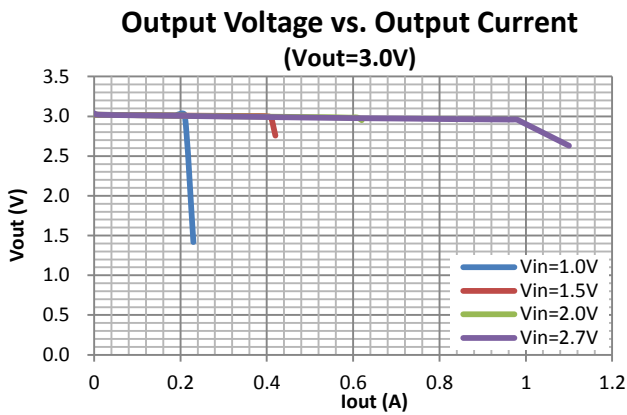
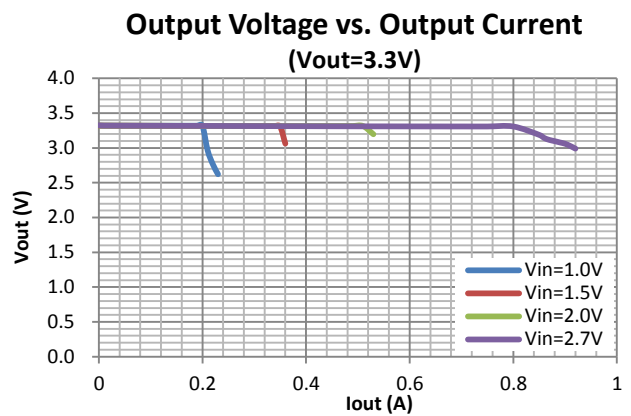
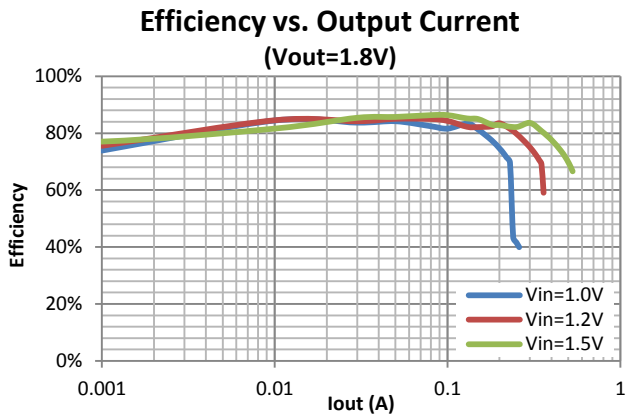
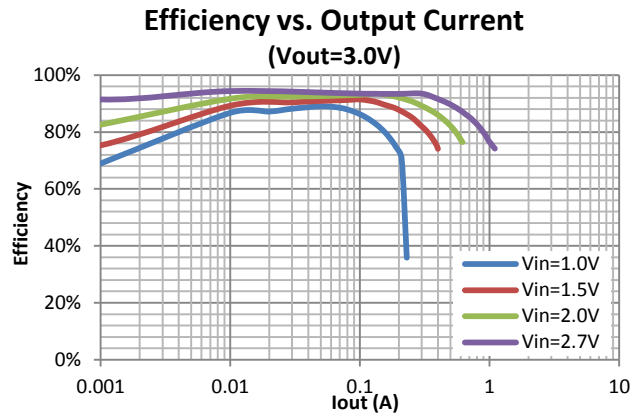
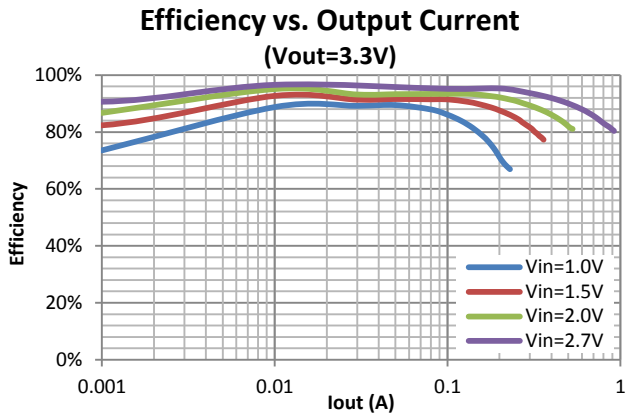

PACKAGE OUTLINE

Package	SOT-23-3	Devices per reel	3000Pcs	Unit	mm
Package dimension:					
<p>Top view dimensions: Total width 2.9 ± 0.2, lead width 0.4 ± 0.1, lead spacing 1.9 ± 0.2 (with 0.95 spacing between leads), body width 1.6 ± 0.2, total height 2.8 ± 0.3, and lead height 1.6 ± 0.2.</p> <p>Side view dimensions: Maximum lead height 1.4 MAX., lead height $1.1 \begin{smallmatrix} +0.2 \\ -0.1 \end{smallmatrix}$, lead width 0.8, lead thickness 0 to 0.1, and lead bottom width $0.16 \begin{smallmatrix} +0.1 \\ -0.06 \end{smallmatrix}$. A minimum lead thickness of 0.2 MIN. is also indicated.</p>					

Package	SOT23-5	Devices per reel	3000	Unit	mm
Package specification:					
<p>Top view dimensions: Total width 2.9 ± 0.2, lead width 0.4 ± 0.1, lead spacing 1.9 ± 0.2 (with 0.95 spacing between leads), body width $1.6 \begin{smallmatrix} +0.2 \\ -0.1 \end{smallmatrix}$, total height 2.8 ± 0.3, and lead height 1.6 ± 0.2.</p> <p>Side view dimensions: Lead height $1.1 \begin{smallmatrix} +0.2 \\ -0.1 \end{smallmatrix}$, lead width 0.8 ± 0.1, lead thickness 0 to 0.1, and lead bottom width $0.15 \begin{smallmatrix} +0.1 \\ -0.05 \end{smallmatrix}$. A minimum lead thickness of 0.2 MIN. is also indicated.</p>					

Package	SOT-89-3	Devices per reel	1000Pcs	Unit	mm
Package dimension:					
<p>The technical drawing illustrates the LC3500 SOT-89-3 package from three perspectives: top, side, and bottom views. The top view shows a rectangular package with a width of 4.5 ± 0.1 mm and a length of 2.5 ± 0.1 mm. A central circular feature has a diameter of $\varnothing 1.0$ mm. Three leads are positioned at the bottom, with a minimum spacing of 0.8 mm between them. The side view shows a maximum height of 4.25 mm, with a lead height of 0.4 ± 0.1 mm and a lead width of 1.5 ± 0.1 mm. The bottom view shows a lead width of 1.5 ± 0.1 mm and a lead thickness of 0.42 ± 0.2 mm. A central feature on the bottom has a width of 0.47 ± 0.1 mm.</p>					

X-ON Electronics

Largest Supplier of Electrical and Electronic Components

Click to view similar products for [Isolated DC/DC Converters](#) category:

Click to view products by [LEADCHIP](#) manufacturer:

Other Similar products are found below :

[ESM6D044440C05AAQ](#) [FMD15.24G](#) [PSL486-7LR](#) [PSR152.5-7IR](#) [Q48T30020-NBB0](#) [AVO240-48S12B-6L](#) [AVO250-48S28B-6L](#) [NAN-0505](#) [HW-L16D](#) [JAHW100Y1](#) [217-1617-001](#) [22827](#) [SPB05C-12](#) [SQ24S15033-PS0S](#) [18952](#) [19-130041](#) [CE-1003](#) [CE-1004](#) [GQ2541-7R](#) [PSE1000DCDC-12V](#) [RDS180245](#) [MAU228](#) [419-2065-201](#) [449-2075-101](#) [J80-0041NL](#) [V300C24C150BG](#) [419-2062-200](#) [419-2063-401](#) [419-2067-101](#) [419-2067-501](#) [419-2068-001](#) [DCG40-5G](#) [DFC15U48D15](#) [449-2067-000](#) [XGS-0512](#) [XGS-1205](#) [XGS-1212](#) [XGS-2412](#) [XGS-2415](#) [XKS-1215](#) [033456](#) [NCT1000N040R050B](#) [SPB05B-15](#) [SPB05C-15](#) [SSQE48T25025-NAA0G](#) [L-DA20](#) [HP3040-9RG](#) [HP1001-9RTG](#) [XKS-2415](#) [XKS-2412](#)