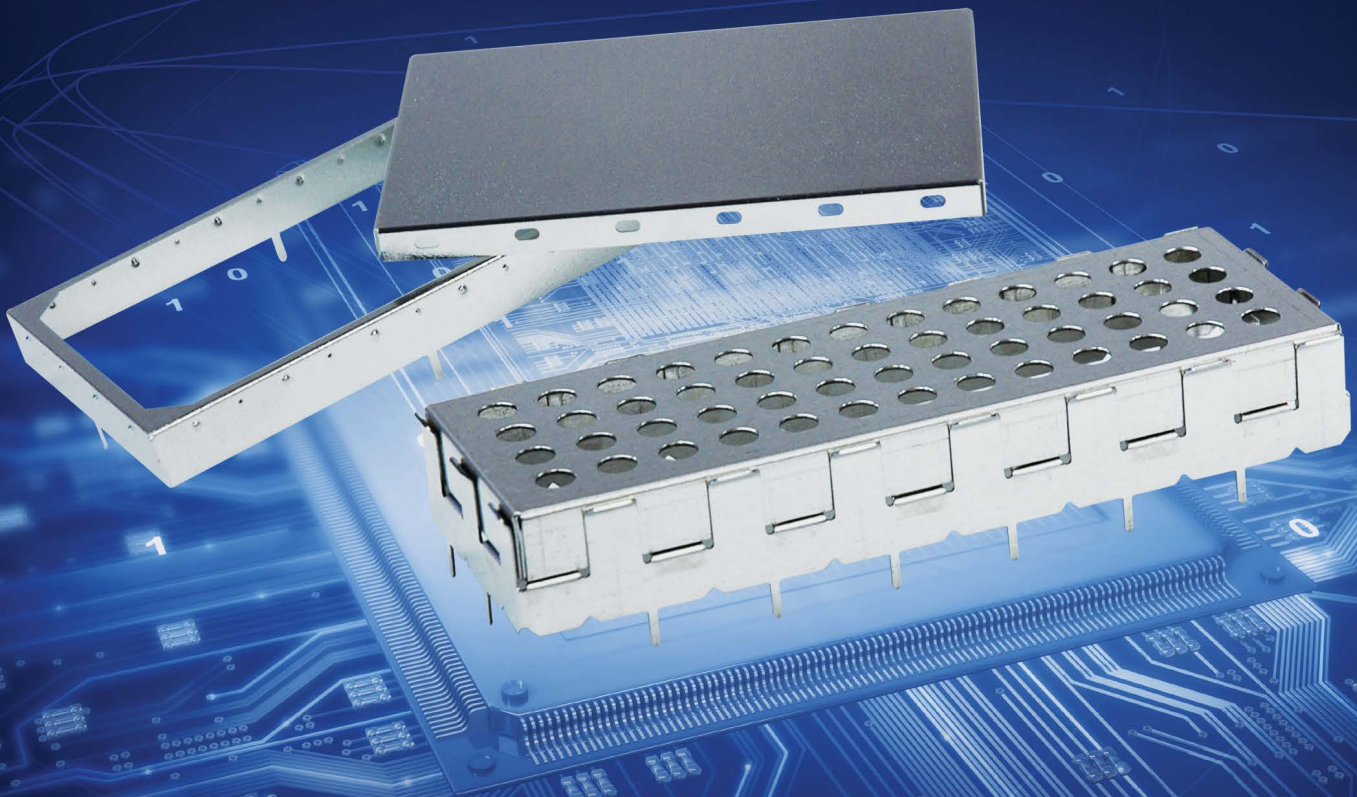


# CBS **CIRCUIT BOARD SHIELDING**

STANDARDS • MODIFIED STANDARDS • CUSTOMS



**LEADER  
TECH**   
a HEICO company

*The Leading Edge In EMI Shielding Technology*

## 1. OUR VISION *(An aspiration worthy to strive for)*

We are committed to being the most reliable and innovative supplier in the EMI/RFI industry, and as our name implies, the leader. In order to achieve this we will consistently strive to provide you with unparalleled service, innovation, and solutions.

## 2. OUR MISSION *(Our daily commitment to you)*

We are committed to consistently provide you with innovation and flexibility of design. Our engineering expertise and conscientious, outstanding customer service that will provide you with the right product, delivered on time. We are dedicated to making you look good to your customers. We want your repeat business.

## 3. OUR PRODUCTS *(Precision engineered to work in your application)*

We are committed to product excellence. We offer our patented Circuit Board Shields (CBS), an extensive range of copper beryllium (CuBE), a Conductive Elastomer product line, TechVENT Honeycomb Panels, TechMESH knitted mesh, microwave absorbers, and FerriShield Ferrites. Using this diverse product line, Leader Tech is positioned to provide you with a 'total shielding solution' for all of your EMI/RFI shielding requirements.

## 4. OUR FACILITIES *(Continually expanding to meet your needs)*

Leader Tech is committed to expansion wherever and whenever necessary. We are constantly expanding our hardware and software capabilities while investing in new equipment to manufacture and deliver the most precise and cost efficient shielding in the industry. Through the continuous support and backing of our parent company HEICO, the possibilities for new space and equipment are an ever-present reality.

## 5. OUR SERVICES *(Consistent reliability each time you order)*

We are committed to excellent service. Our staff undergoes a rigorous daily product, sales, and service training in order to serve you better. We want your calls answered by a person, not a machine, someone trained to qualify your needs and get answers to you when you need them. At Leader Tech we believe that the right people and the right equipment go hand in hand.



ISO 9001: 2008  
CERTIFIED



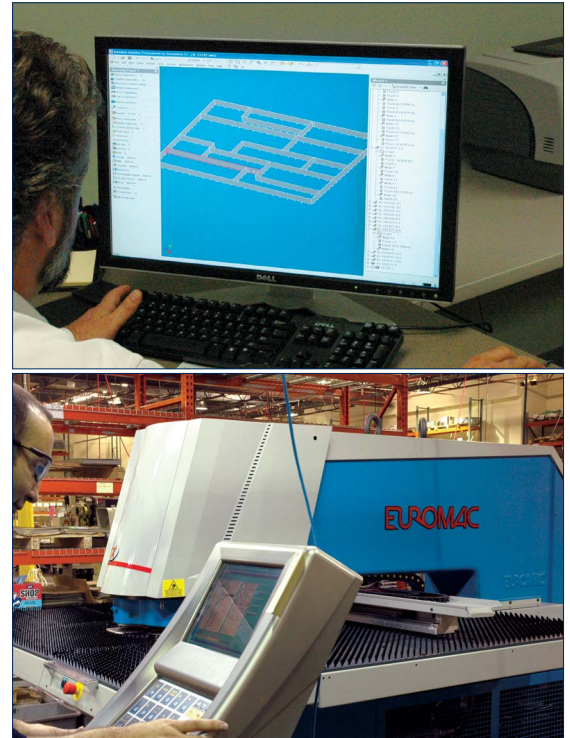
<b>CBS Circuit Board Shielding</b>		
<b>2</b>	Intro to CBS	
<b>3</b>	Shielding at the Source	
<b>Standard CBS</b>		
<b>4</b>	10 and 20 Series . . . . . <i>Shield heights from .130"</i>	
<b>6</b>	40 Series . . . . . <i>Shield heights from .400"</i>	
<b>8</b>	50 Series . . . . . <i>Shield heights from .500"</i>	
<b>10</b>	80 Series . . . . . <i>Shield heights from .800"</i>	
<b>12</b>	KE Series . . . . . <i>Offers alternate pin placement across various shield heights</i>	
<b>14</b>	CBS2 . . . . . <i>Self-contained, 6-sided enclosure</i>	
<b>16</b>	Multi-Cavity CBS . . . . . <i>Isolate multiple components in one shield</i>	
<b>17</b>	CBS Engineering Notes . . . <i>Technical specifications</i>	
<b>Modified CBS</b>		
<b>15</b>	Modified CBS . . . . . <i>Near custom solutions without the cost</i>	
<b>Slot-Lok™ Shields</b>		
<b>18</b>	Slot-Lok™ Standard . . . . . <i>Quick-Turn, Near-Custom Shielding</i>	
<b>19</b>	Slot-Lok™ . . . . . <i>Enhanced Slot-Lok™ shielding variation</i>	
<b>20</b>	Low Profile Slot-Lok™ . . . <i>Shield heights less than .150"</i>	
<b>21</b>	Multi-Cavity Slot-Lok™ . . . <i>Isolate multiple components in one shield</i>	
<b>Custom Shielding</b>		
<b>22</b>	Custom Shielding . . . . . <i>Unlimited design and production options</i>	
<b>Related Technical Information</b>		
<b>23</b>	Packaging and Materials	
<b>24</b>	Products and Literature	
<b>25</b>	Global EMI Technology Center	
<b>26</b>	CBS Part Number Builder	

Circuit Board Shields (CBS) Using Standard Modular off-the-shelf Fence and Covers.

## It's Our Legacy!

EMI designers demand extremely tight circuit board shields to prevent EMI/RFI radiation and susceptibility. This CBS Circuit Board Shielding Design Guide features multiple design variations of Leader Tech's patented two-piece construction with a solderable fence and removable cover, considered by designers to have the strongest cover retention in the industry. It provides protection for sensitive components while allowing your technician access to adjust and repair.

Leader Tech provides EMI designers flexibility and cost-effective custom solutions. This is achieved by stocking a large variety of standard "off-the-shelf" fence options, which can be formed and combined with a cover to create a fully custom design. Additional features such as special cutouts, vent holes, insulating materials and other special requirements, can be added to create the right Circuit Board Shield for your application. Avoid long lead-times and expensive custom tooling by reviewing these EMI shielding innovations and selecting the right one for your next application. You will find that Leader Tech's product diversity includes simple one-piece shields to more complicated multi-cavity shields using a variety of through-hole and surface mounting options.



## WELCOME TO LEADER TECH CBS



## Diverse board-level shielding solutions for all electronic applications

Leader Tech is not a one-product-fits-all company. We are innovators focused on constant improvement and refinement of proven product platforms and manufacturing methods. This allows us to deliver cost-effective shielding solutions that solve EMI problems for both current and emerging electronic applications.

From small footprints and low-profile applications to multi-level board designs, we offer a wide selection of standard, modified standard and custom board level shielding products to fit your exact specifications.

Four of the Leader Tech's most popular product lines are described below. Additionally, the product comparison chart allows for "at-a-glance" comparisons of all design options.

### Leader Tech Standard CBS

#### Simply one of the best shields ever made.

Our standard CBS products lead the board-level shielding industry in performance, flexibility and value. The highly reliable 2-piece design (fence and cover) accommodates virtually any through-hole or surface mount application.

### Multi-Cavity designs

#### When space, weight and costs are all design priorities.

Our flexible CBS and Slot Lok design and manufacturing processes allow engineers to effectively isolate multiple components using the same shield. The custom designed product typically incorporates multiple internal cavities that share connecting walls and a single cover. This allows for a reduction in shield weight and occupied board space.

### Slot-Lok™ Shields

#### As close to custom as you can get...without the cost!

Slot-Lok™ shields are designed and manufactured using proprietary methods that increase shield design flexibility while reducing lead time and total product cost. If you need a cost-effective shielding solution with near limitless design flexibility, Slot-Lok™ is the option of choice.

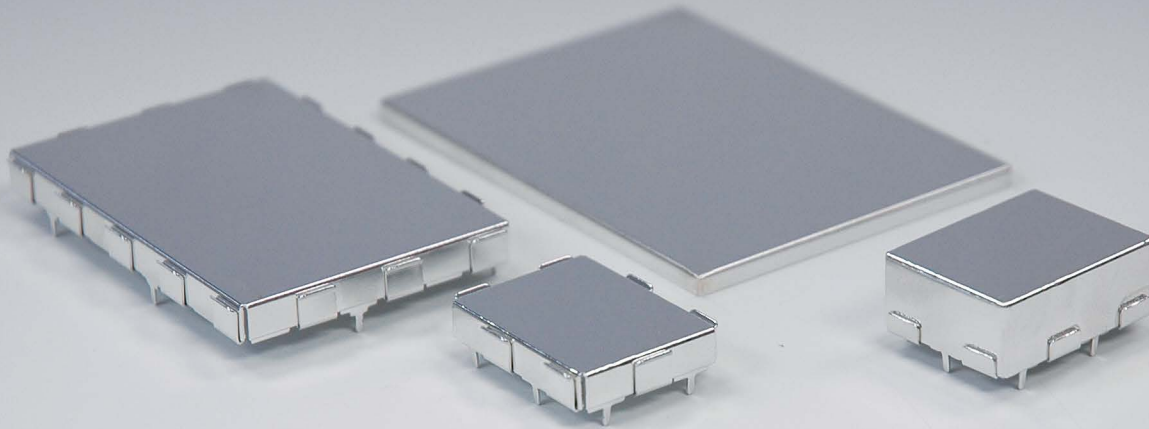
### Custom shielding solutions

#### If you can describe it, we can manufacture it.

Decades of engineering and manufacturing experience provide you with the ultimate board level shielding flexibility. From 3D modeling, material selection and prototyping to high volume production, we are with you every step of the way.

## Product Comparison Chart

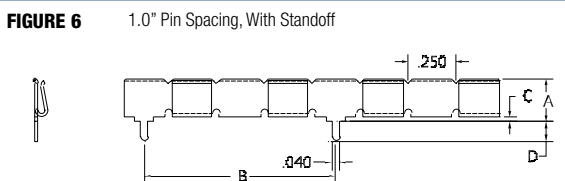
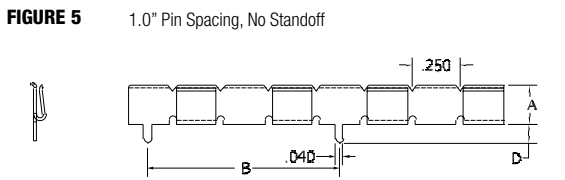
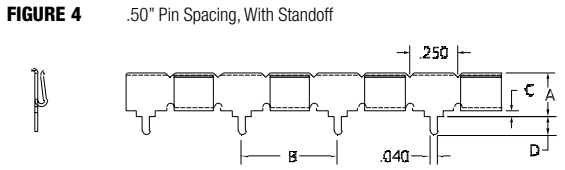
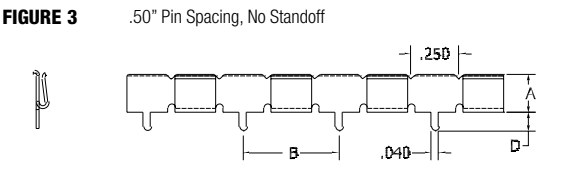
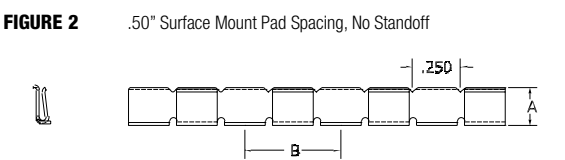
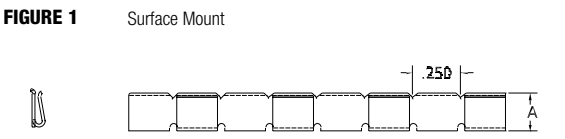
						
PARAMETERS	STD. CBS	KE CBS	MODIFIED STD.	SLOT-LOK™	MULTI-CAVITY	CUSTOM
Through-Hole	Yes	Yes	Yes	Yes	Yes	Yes
Surface Mount	Yes	Yes	Yes	Yes	Yes	Yes
Height Flexibility	0.13"-4.0"	0.40"-2.0"	0.13"-4.0"	.080"-2.0"	0.10"-2.0"	from .080"
Design Flexibility	Good	Good	Very Good	Very Good	Very Good	Excellent
Material Flexibility	Very Good	Very Good	Very Good	Very Good	Very Good	Excellent
Shielding Effectiveness	Excellent	Excellent	Excellent	Excellent	Excellent	Excellent
Cover Retention	Excellent	Excellent	Excellent	Very Good	Very Good	Excellent
Tooling/NRE	None	None	Low	Low	Low-Med	Low-Med
Lead-Times	Excellent	Excellent	Excellent	Very Good	Very Good	Very Good
RoHS Compliant	Yes	Yes	Yes	Yes	Yes	Yes



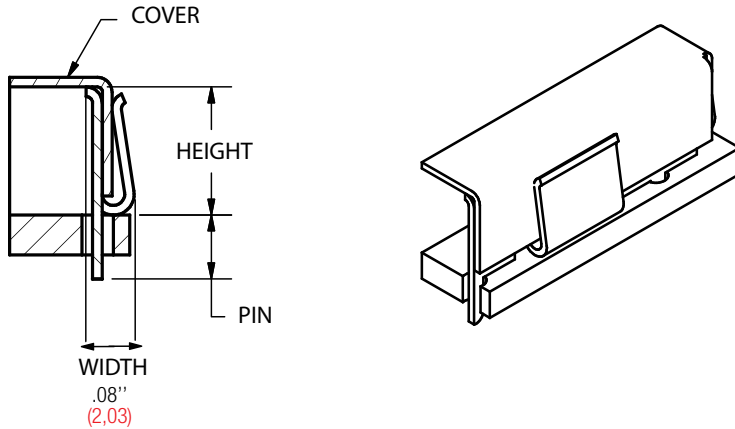
<b>10 - CBS Series</b>		Black = inches		Red = mm	
STYLE	FIG.	A HEIGHT	B PIN SPACING	C STANDOFFS	D PIN LENGTH
10-CBS surface mount	1	.13 (3,30)	none	none	none
14-CBS	5	.13 (3,30)	1.0 (25,4)	none	.05 (1,27)
14R-CBS	3	.13 (3,30)	.50 (12,7)	none	.10 (2,54)
14RA-CBS	3	.13 (3,30)	.50 (12,7)	none	.05 (1,27)
18R-CBS	3	.13 (3,30)	.50 (12,7)	none	.13 (3,30)

<b>20 - CBS Series</b>		Black = inches		Red = mm	
STYLE	FIG.	A HEIGHT	B PIN SPACING	C STANDOFFS	D PIN LENGTH
20-CBS surface mount	1	.200 (5,08)	none	none	none
20S-CBS surface mount	2	.200 (5,08)	.50 (12,7) pad spacing	none	.21L (5,33) .075W (1,90)
21L-CBS	4	.225 (5,72)	.50 (12,7)	.025 (.63)	.15 (3,81)
21M-CBS	4	.225 (5,72)	.50 (12,7)	.025 (.63)	.13 (3,30)
21-CBS	4	.225 (5,72)	.50 (12,7)	.025 (.63)	.10 (2,54)
22-CBS	5	.200 (5,08)	1.0 (25,4)	none	.10 (2,54)
23-CBS	4	.250 (6,35)	.50 (12,7)	.050 (1,27)	.10 (2,54)
24-CBS	3	.200 (5,08)	.50 (12,7)	none	.10 (2,54)
24S-CBS	3	.200 (5,08)	.50 (12,7)	none	.05 (1,27)
25-CBS	6	.225 (5,72)	1.0 (25,4)	.025 (.63)	.10 (2,54)
29-CBS	3	.200 (5,08)	.50 (12,7)	none	.13 (3,30)

- NOTES**
- Drawings in figures 1-6 are not to scale; see chart for sizing
  - Standard material .015" (.38) pre-tin plated steel
  - Other cover heights available, consult factory
  - Standard cover height: .115" (2,92) 10-CBS  
.185" (4,70) 20-CBS



**CBS 10 and 20 Series Configuration**

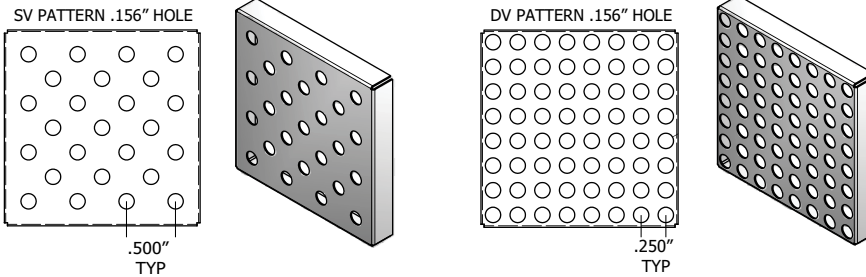


AVAILABLE HEIGHTS:

10 SERIES - .13" TO 2.0" (3,3 TO 50,8) 20 SERIES - .20" TO 2.0" (5,08 TO 50,8)

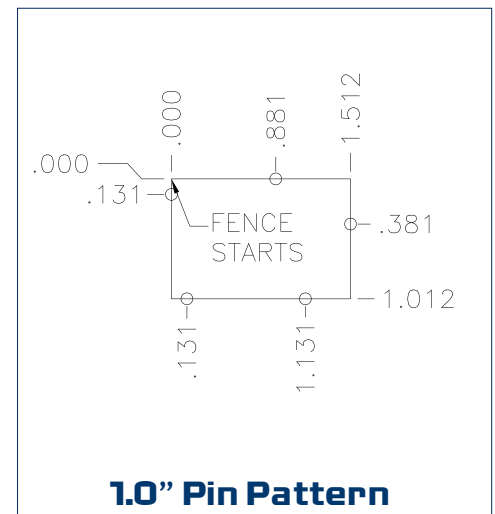
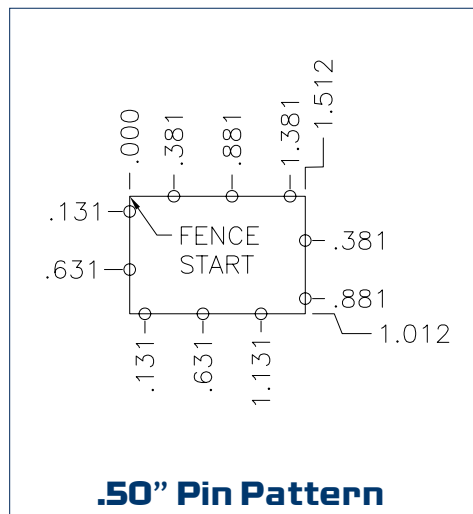
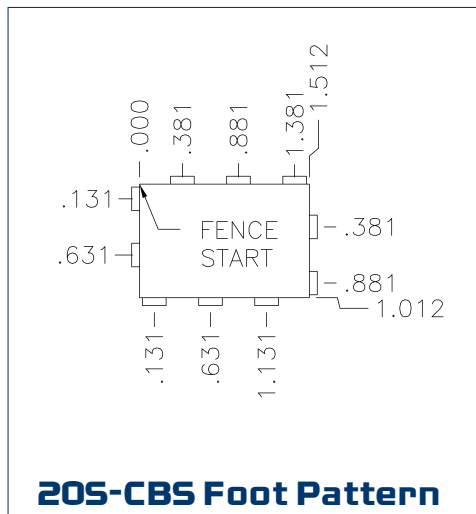
Recommended hole size: .050" (1,27)

**Ventilation Patterns**



Single density and double density ventilation holes available upon request.  
SV/DV (Standard) = .156" dia. SV2/DV2 (Alternate) = .08" dia.

**Mounting Hole Patterns (10 and 20 series)**



Pin pattern viewed from top of shield. Consult factory for pin patterns for your application

**10 and 20 Series Specs**

**Sizes:** .50" x .50" to 12" x 24" (.25" increments)

**Shapes:** Squares, rectangles and odd shapes in .25" increments

**Heights:** .13" to 2.00"

**Mounting Pins:** .50" or 1.00" spacing

**Surface Mount:** Available for all 10 and 20 series CBS

**Std Material:** .015" (.38) pre-tin plated steel

**Cover Retention:** 1.5 - 2.5 lb./linear inch

**Shielding Effectiveness:** up to 60 dB

**Standard Options**

- Formed fence and cover - unassembled (F)
- Assembled fence and cover (A)
- Flat fence and formed cover (U)
- Pre-tin plated Phos Bronze (P), Alloy 770 (N)
- Ventilation holes (SV 15% or DV 30%)

**Ordering a CBS is Easy**

1. Select your style number - **"21-CBS"**
2. Choose standard options listed above - **"21-CBSFNSV"**
3. Specify your width in .25" increments from .50" to 12.00" - **"21-CBSFNSV-2.5"**
4. Specify your length in .25" increments from .50" to 24.00" - **"21-CBSFNSV-2.5x4.5"**
5. Specify your height from board to inside cover from .13" to 2.00" **"21-CBSFNSV-2.5x4.5x.225"**

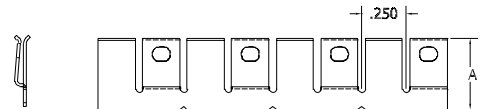


<b>40-CBS Series</b>		Black = inches		Red = mm	
STYLE	FIG.	A HEIGHT	B PIN SPACING	C STANDOFFS	D PIN LENGTH
40-CBS surface mount	1	.40 (10,16)	none	none	none
42-CBS	3	.40 (10,16)	1.0 (25,4)	none	.12 (3,05)
44-CBS	2	.40 (10,16)	.50 (12,7)	none	.12 (3,05)
45-CBS	4	.40 (10,16)	1.0 (25,4)	.010 (.25)	.12 (3,05)
47-CBS	4	.40 (10,16)	1.0 (25,4)	.010 (.25)	.15 (3,81)
48-CBS	2	.40 (10,16)	.50 (12,7)	none	.15 (3,81)
49-CBS	5	.40 (10,16)	.25 (6,35)	none	.12 (3,05)
49L-CBS	6	.40 (10,16)	.25 (6,35)	.005 (.13)	.12 (3,05)

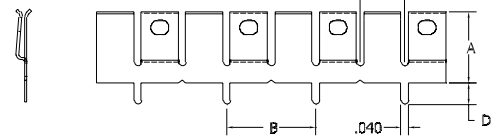
**NOTES**

- Drawings in figures 1-6 are not to scale; see chart for sizing
- Standard cover height: .280" (7,11) 40-CBS
- Other cover heights available, consult factory

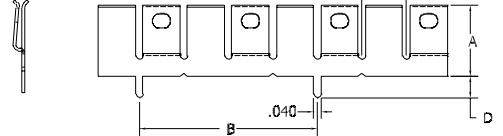
**FIGURE 1** Surface Mount



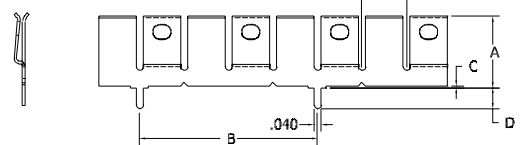
**FIGURE 2** .50" Pin Spacing, No Standoff



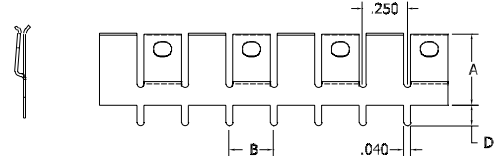
**FIGURE 3** 1.0" Pin Spacing, No Standoff



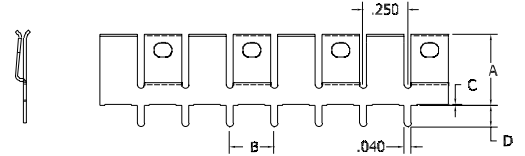
**FIGURE 4** 1.0" Pin Spacing, With Standoff



**FIGURE 5** .25" Pin Spacing, No Standoff

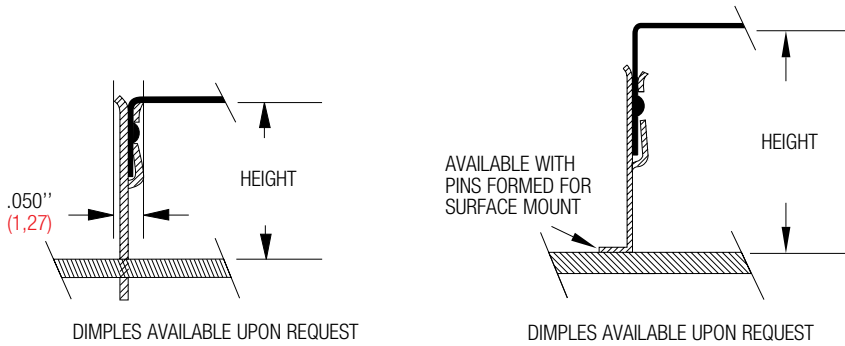


**FIGURE 6** .25" Pin Spacing, With Standoff



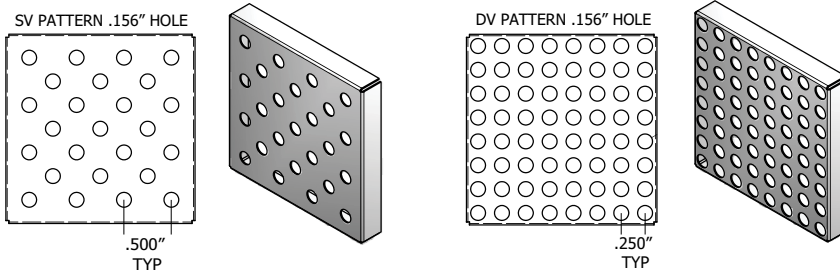


**CBS 40 Series Configuration**



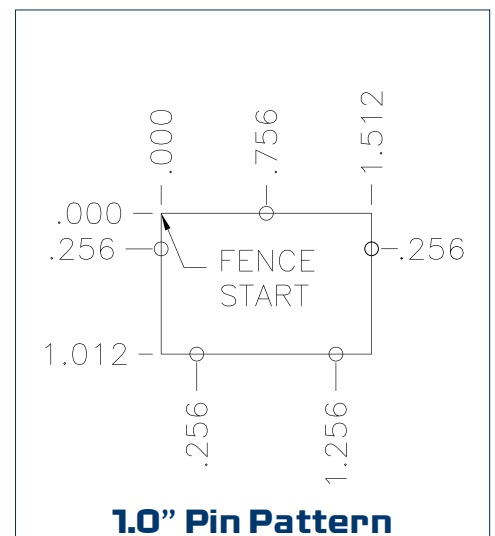
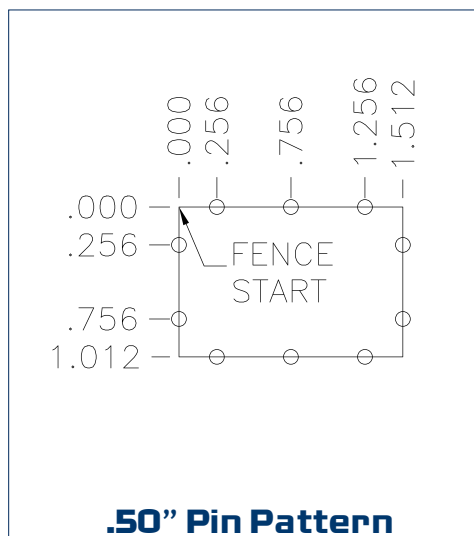
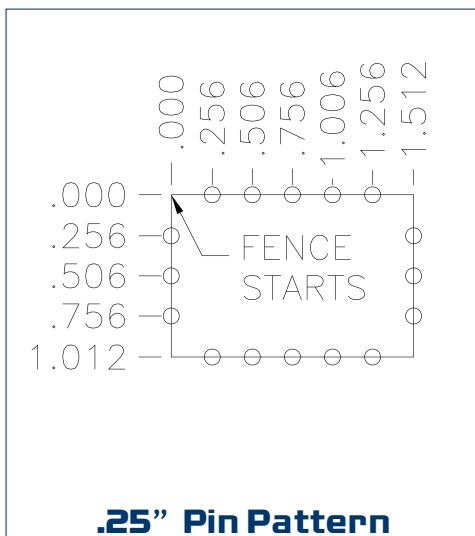
AVAILABLE HEIGHTS:  
 40 SERIES - .40" TO 2.0" (10,16 TO 50,5)  
 Recommended hole size: .050" (1,27)

**Ventilation Patterns**



Single density and double density ventilation holes available upon request.  
 SV/DV (Standard) = .156" dia. SV2/DV2 (Alternate) = .08" dia.

**Mounting Hole Patterns (40 series)**



Pin pattern viewed from top of shield. Consult factory for pin patterns for your application

**40 Series Specs**

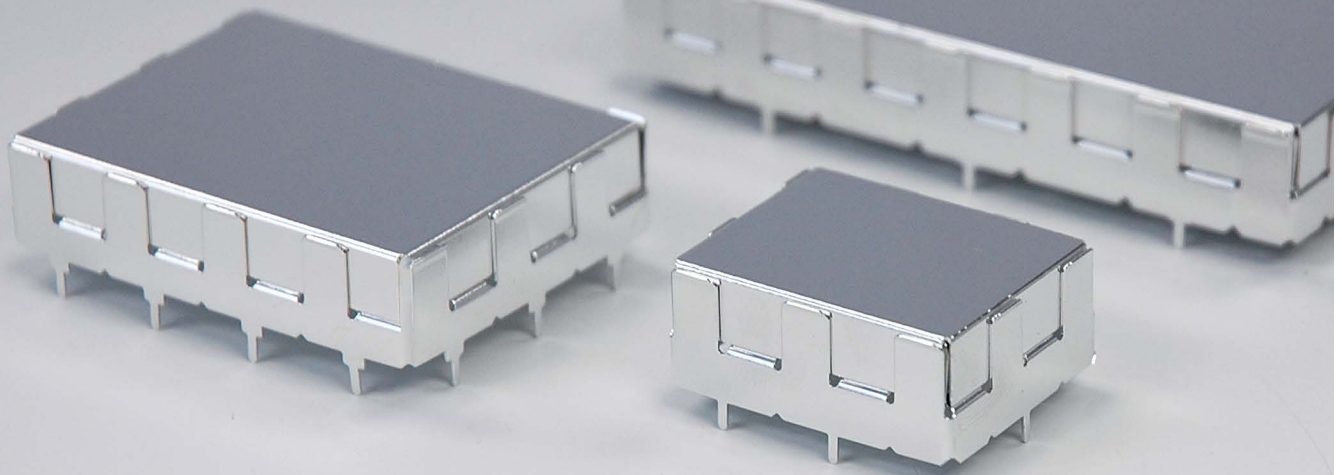
- Sizes:** .50" x .50" to 12" x 24" (.25" increments)
- Shapes:** Squares, rectangles and odd shapes in .25" increments
- Heights:** .40" to 3.00"
- Mounting Pins:** .25", .50" or 1.00" spacing
- Surface Mount:** Available for all 40 series CBS
- Std Material:** .015" (.38) pre-tin plated steel
- Cover Retention:** 1.5 - 2.5 lb./linear inch
- Shielding Effectiveness:** up to 60 dB

**Standard Options**

- Formed fence and cover - unassembled (F)
- Assembled fence and cover (A)
- Flat fence and formed cover (U)
- Pre-tin plated Phos Bronze (P), Alloy 770 (N)
- Ventilation holes (SV 15% or DV 30%)
- Dimples for improved retention (D)

**Ordering a CBS is Easy**

1. Select your style number - **"42-CBS"**
2. Choose standard options listed above - **"42-CBSFNSV"**
3. Specify your width in .25" increments from .50" to 12.00" - **"42-CBSFNSV-2.5"**
4. Specify your length in .25" increments from .50" to 24.00" - **"42-CBSFNSV-2.5x4.5"**
5. Specify your height from board to inside cover from .40" to 2.00" **"42-CBSFNSV-2.5x4.5x.40"**



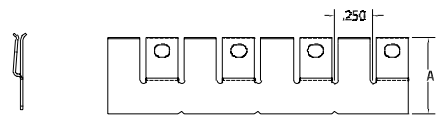
<b>50-CBS Series</b>		Black = inches		Red = mm			
STYLE	FIG.	A HEIGHT	B PIN SPACING	C STANDOFFS	D PIN LENGTH		
50-CBS surface mount	1	.50 (12,7)	none	none	none		
51-CBS	5	.50 (12,7)	1.0 (25,4)	.05 (1,27)	.12 (3,05)		
52-CBS	4	.50 (12,7)	1.0 (25,4)	none	.12 (3,05)		
52NN-CBS	4*	.50 (12,7)	1.0 (25,4)	none	.12 (3,05)		
53-CBS	3	.50 (12,7)	.50 (12,7)	.05 (1,27)	.12 (3,05)		
53A-CBS	3	.50 (12,7)	.50 (12,7)	.05 (1,27)	.06 (1,53)		
54-CBS	2	.50 (12,7)	.50 (12,7)	none	.12 (3,05)		
55-CBS	5	.50 (12,7)	1.0 (25,4)	.01 (.250)	.12 (3,05)		
56-CBS	5	.50 (12,7)	1.0 (25,4)	.05 (1,27)	.15 (3,81)		
57-CBS	5	.50 (12,7)	1.0 (25,4)	.01 (.250)	.15 (3,81)		
58-CBS	2	.50 (12,7)	.50 (12,7)	none	.15 (3,81)		
59-CBS	6	.50 (12,7)	.25 (6,35)	none	.12 (3,05)		

**NOTES**

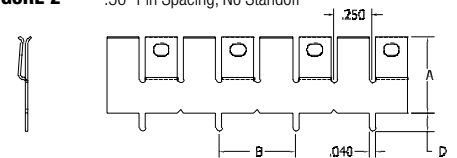
- Drawings in figures 1-6 are not to scale; see chart for sizing
- Standard cover height: .280" (7,11) 50-CBS
- Other cover heights available, consult factory
- \*52NN-CBS has no v-notches as depicted in fig. 4



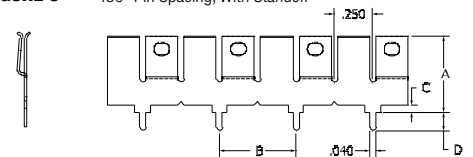
**FIGURE 1** Surface Mount



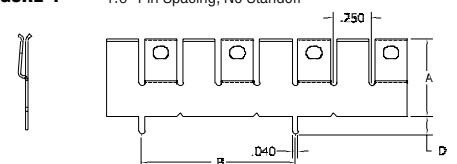
**FIGURE 2** .50" Pin Spacing, No Standoff



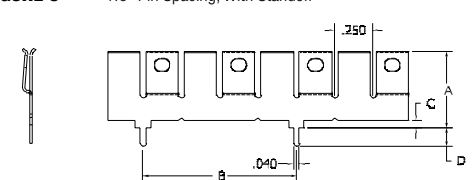
**FIGURE 3** .50" Pin Spacing, With Standoff



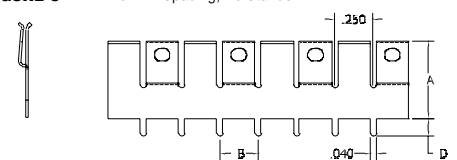
**FIGURE 4** 1.0" Pin Spacing, No Standoff



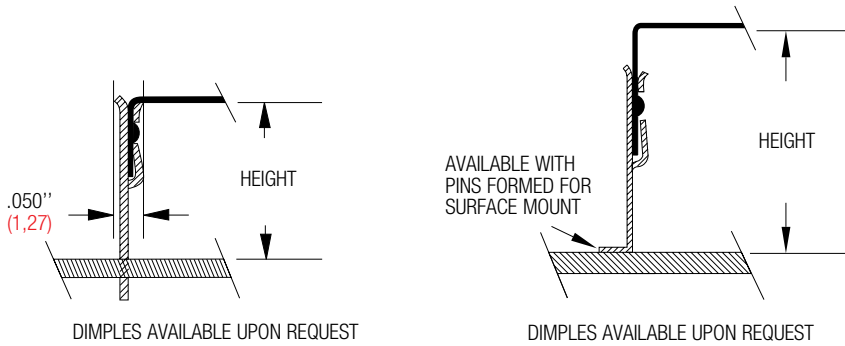
**FIGURE 5** 1.0" Pin Spacing, With Standoff



**FIGURE 6** .25" Pin Spacing, No Standoff

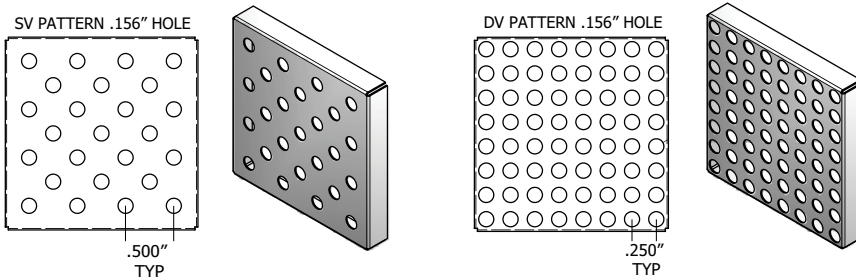


**CBS 50 Series Configuration**



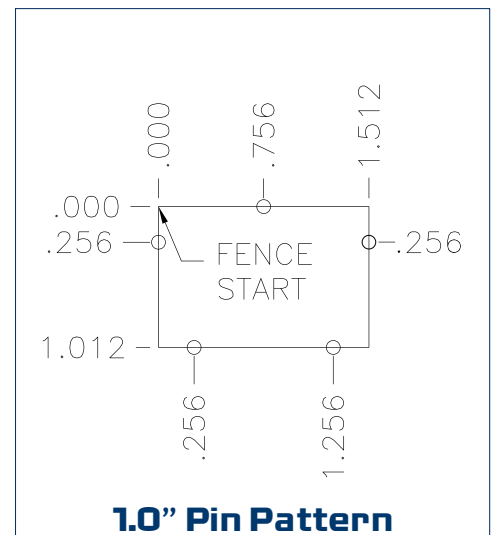
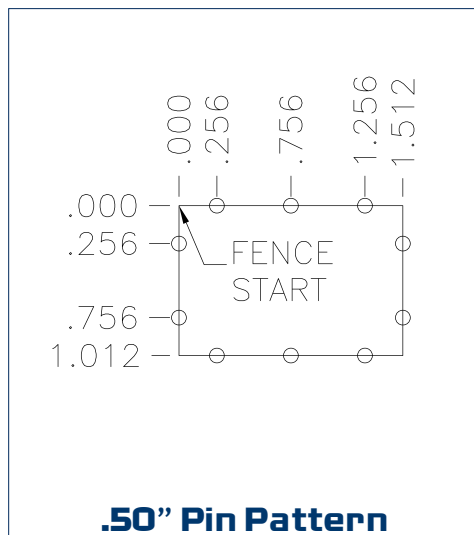
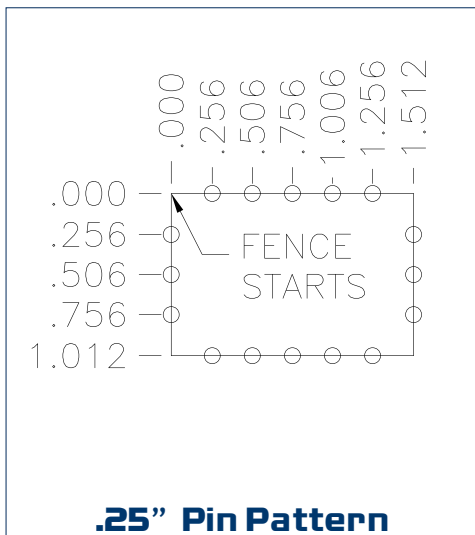
AVAILABLE HEIGHTS:  
 50 SERIES - .50" TO 2.0" (12,7 TO 50,5)  
 Recommended hole size: .050" (1,27)

**Ventilation Patterns**



Single density and double density ventilation holes available upon request.  
 SV/DV (Standard) = .156" SV2/DV2(Alternate) = .08"

**Mounting Hole Patterns (50 series)**



Pin pattern viewed from top of shield. Consult factory for pin patterns for your application

**50 Series Specs**

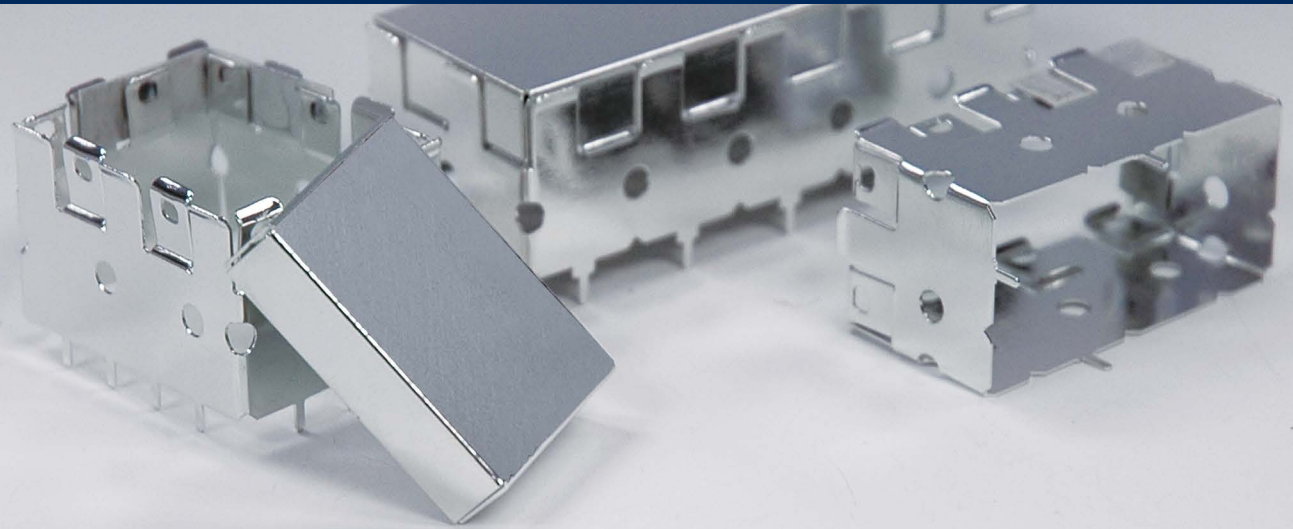
- Sizes:** .50" x .50" to 12" x 24" (.25" increments)
- Shapes:** Squares, Rectangles and Odd Shapes in .25" increments
- Heights:** .50" to 3.00"
- Mounting Pins:** .25", .50" or 1.00" spacing
- Surface Mount:** Available for all 50 series CBS
- Std Material:** .015" (.38) pre-tin plated steel
- Cover Retention:** 1.5 - 2.5 lb./linear inch
- Shielding Effectiveness:** up to 60 dB

**Standard Options**

- Formed fence and cover - unassembled (F)
- Assembled fence and cover (A)
- Flat fence and formed cover (U)
- Pre-tin plated Phos Bronze (P), Alloy 770 (N)
- Ventilation holes (SV 15% or DV 30%)
- Dimples for improved retention (D)

**Ordering a CBS is Easy**

1. Select your style number - **"51-CBS"**
2. Choose standard options listed above - **"51-CBSFNSV"**
3. Specify your width in .25" increments from .50" to 12.00" - **"51-CBSFNSV-2.5"**
4. Specify your length in .25" increments from .50" to 24.00" - **"51-CBSFNSV-2.5x4.5"**
5. Specify your height from board to inside cover from .50" to 2.00" **"51-CBSFNSV-2.5x4.5x.50"**



**80-CBS Series**

Black = inches Red = mm

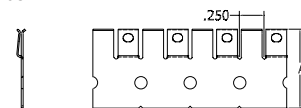
STYLE	FIG.	A HEIGHT	B PIN SPACING	C STANDOFFS	D PIN LENGTH
80-CBS surface mount	1	.80 (20,3)	none	none	none
81-CBS	7	.80 (20,3)	1.0 (25,4)	.05 (1,27)	.12 (3,05)
82-CBS	5	.80 (20,3)	1.0 (25,4)	none	.12 (3,05)
82NH	6	.80 (20,3)	1.0 (25,4)	none	.12 (3,05)
83-CBS	4	.80 (20,3)	.50 (12,7)	.05 (1,27)	.12 (3,05)
83A-CBS	4	.80 (20,3)	.50 (12,7)	.05 (1,27)	.06 (1,53)
84-CBS	2	.80 (20,3)	.50 (12,7)	none	.12 (3,05)
84NH	3	.80 (20,3)	.50 (12,7)	none	.12 (3,05)
84VH	9	.80 (20,3)	.50 (12,7)	none	.12 (3,05)
85-CBS	7	.80 (20,3)	1.0 (25,4)	.01 (,250)	.12 (3,05)
86-CBS	7	.80 (20,3)	1.0 (25,4)	.05 (1,27)	.15 (3,81)
87-CBS	7	.80 (20,3)	1.0 (25,4)	.01 (,250)	.15 (3,81)
88-CBS	2	.80 (20,3)	.50 (12,7)	none	.15 (3,81)
89-CBS	8	.80 (20,3)	.25 (6,35)	none	.12 (3,05)

**NOTES**

- Drawings in figures 1-9 are not to scale; see chart for sizing
- Standard cover height .280" (7,11) 80-CBS
- Other cover heights available, consult factory

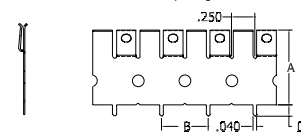
**FIGURE 1**

Surface Mount



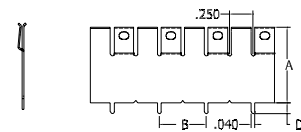
**FIGURE 2**

.50" Pin Spacing, No Standoff, With Holes



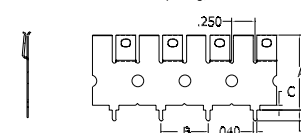
**FIGURE 3**

.50" Pin Spacing, No Standoff, No Holes



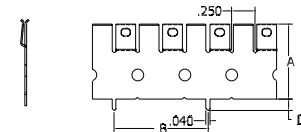
**FIGURE 4**

.50" Pin Spacing, With Standoff



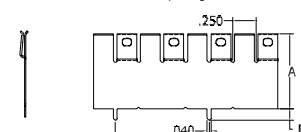
**FIGURE 5**

1.0" Pin Spacing, No Standoff, With Holes



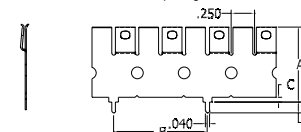
**FIGURE 6**

1.0" Pin Spacing, No Standoff, No Holes



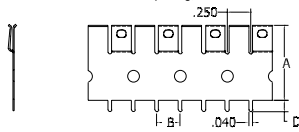
**FIGURE 7**

1.0" Pin Spacing, With Standoff, with holes



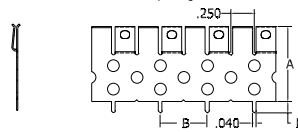
**FIGURE 8**

.25" Pin Spacing, No Standoff

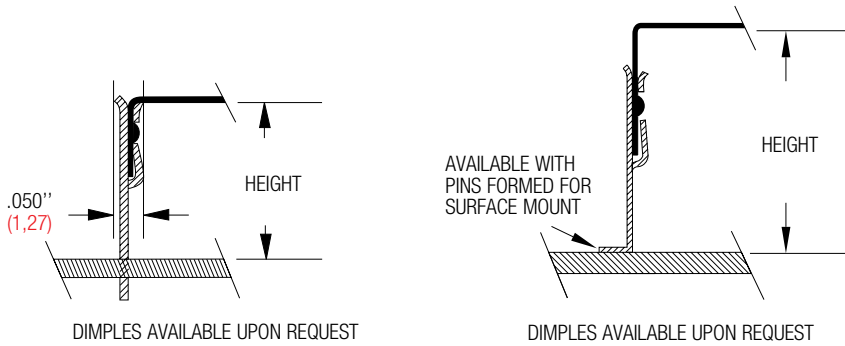


**FIGURE 9**

.50" Pin Spacing, No Standoff

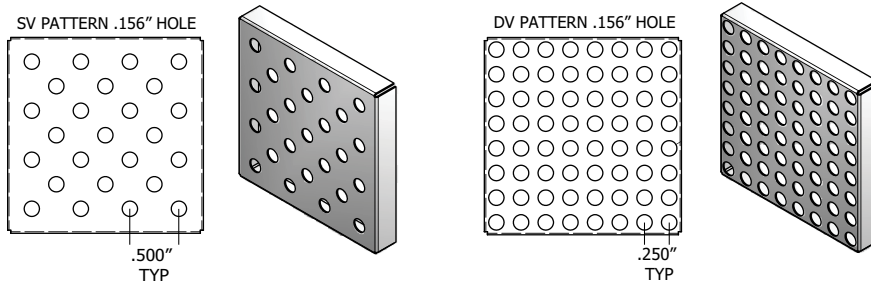


**CBS 80 Series Configuration**



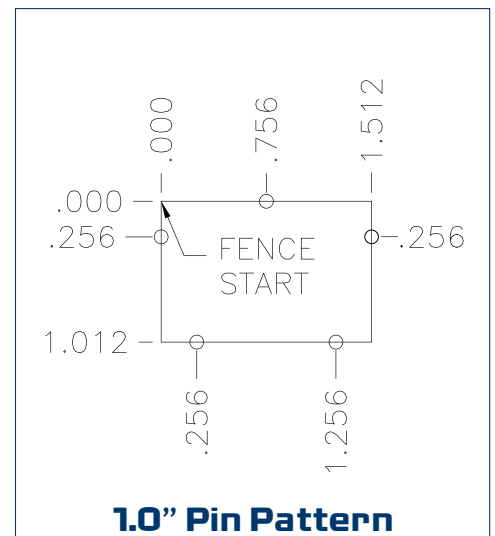
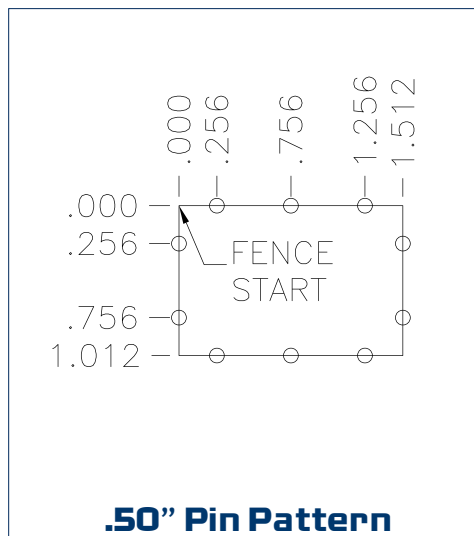
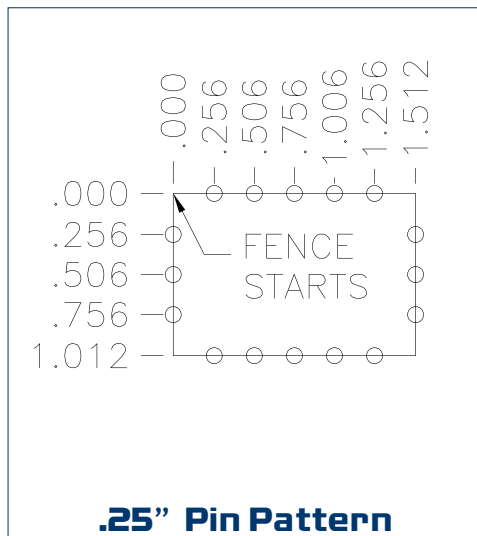
AVAILABLE HEIGHTS:  
 80 SERIES - .80" TO 2.0" (20,3 TO 50,5)  
 Recommended hole size: .050" (1,27)

**Ventilation Patterns**



Single density and double density ventilation holes available upon request.  
 SV/DV (Standard) = .156" dia. SV2/DV2 (Alternate) = .08" dia.

**Mounting Hole Patterns (80 series)**



Pin pattern viewed from top of shield. Consult factory for pin patterns for your application

**80 Series Specs**

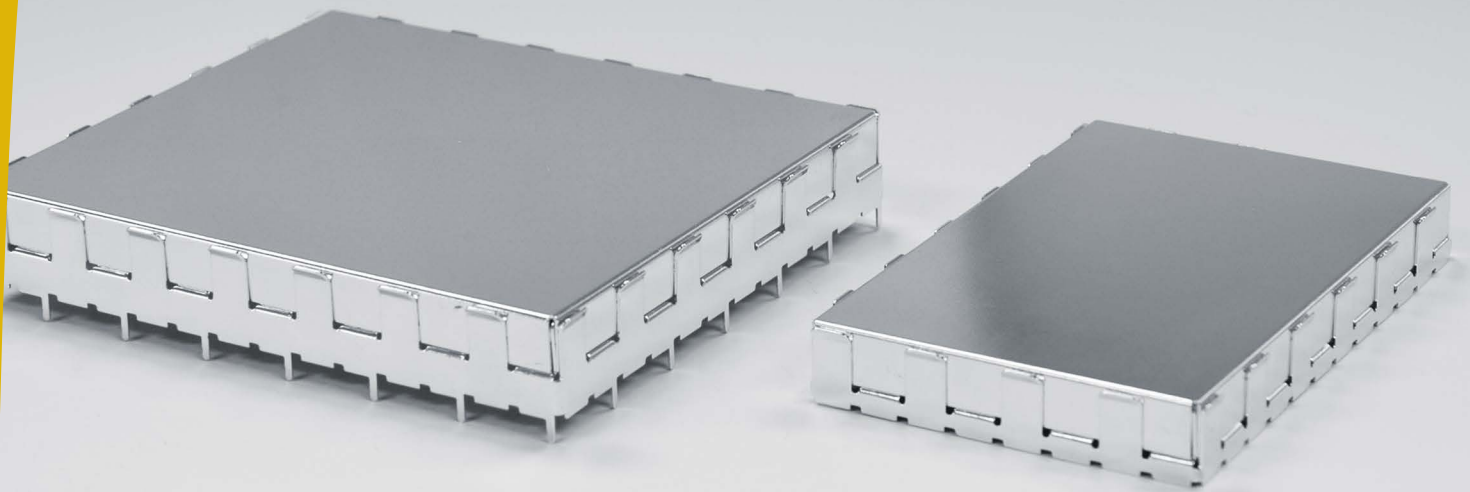
- Sizes:** .50" x .50" to 12" x 24" (.25" increments)
- Shapes:** Squares, rectangles and odd shapes in .25" increments
- Heights:** .80" to 4.00"
- Mounting Pins:** .25", .50" or 1.00" spacing
- Surface Mount:** Available for all 80 series CBS
- Std Material:** .015" (.38) pre-tin plated steel
- Cover Retention:** 1.5 - 2.5 lb./linear inch
- Shielding Effectiveness:** up to 60 dB

**Standard Options**

- Formed fence and cover - unassembled (F)
- Assembled fence and cover (A)
- Flat fence and formed cover (U)
- Pre-tin plated Phos Bronze (P), Alloy 770 (N)
- Ventilation holes (SV 15% or DV 30%)
- Dimples for improved retention (D)

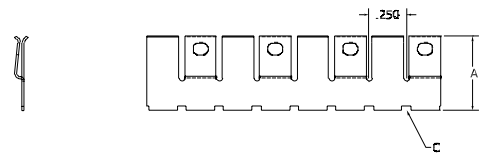
**Ordering a CBS is Easy**

1. Select your style number - **"81-CBS"**
2. Choose standard options listed above - **"81-CBSFNSV"**
3. Specify your width in .25" increments from .50" to 12.00" - **"81-CBSFNSV-2.5"**
4. Specify your length in .25" increments from .50" to 24.00" - **"81-CBSFNSV-2.5x4.5"**
5. Specify your height from board to inside cover from .80" to 2.00" **"81-CBSFNSV-2.5x4.5x.80"**

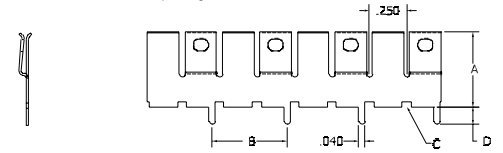


<b>CBS KE Series</b>		Black = inches		Red = mm	
STYLE	FIG.	A HEIGHT	B PIN SPACING	C NOTCH SIZE	D PIN LENGTH
KE40 Surface mount	1	.40 (10,16)	none	.03H (0,76) .06W (1,52)	none
KE44	2	.40 (10,16)	.50 (12,7)	.03H (0,76) .06W (1,52)	.12 (3,05)
KE49	3	.40 (10,16)	.25 (6,35)	.03H (0,76) .06W (1,52)	.12 (3,05)
KE50 Surface mount	1	.50 (12,70)	none	.03H (0,76) .06W (1,52)	none
KE54	2	.50 (12,70)	.50 (12,7)	.03H (0,76) .06W (1,52)	.12 (3,05)
KE59	3	.50 (12,70)	.25 (6,35)	.03H (0,76) .06W (1,52)	.12 (3,05)
KE80 Surface mount	1	.80 (20,32)	none	.03H (0,76) .06W (1,52)	none
KE84	2	.80 (20,32)	.50 (12,7)	.03H (0,76) .06W (1,52)	.12 (3,05)
KE89	3	.80 (20,32)	.25 (6,35)	.03H (0,76) .06W (1,52)	.12 (3,05)

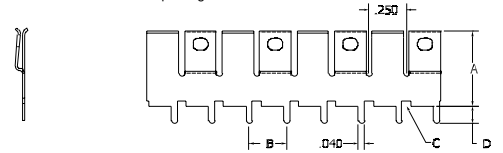
**FIGURE 1** Surface Mount



**FIGURE 2** .50" Pin Spacing



**FIGURE 3** .25" Pin Spacing

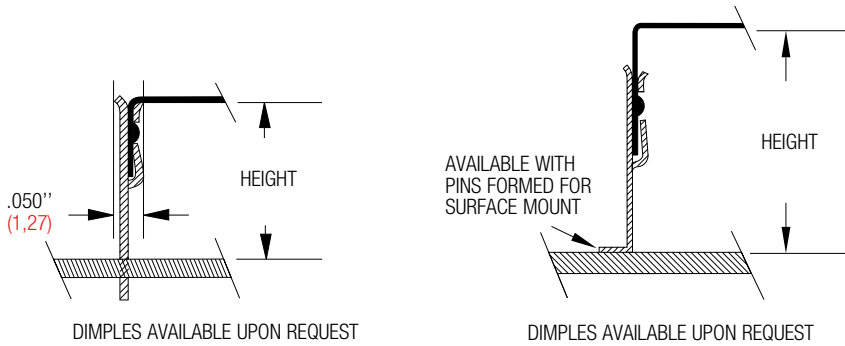


**NOTES**

- Drawings in figures 1-3 are not to scale; see chart for sizing
- Standard cover height: .280" (7,11) KE-CBS
- Other cover heights available, consult factory

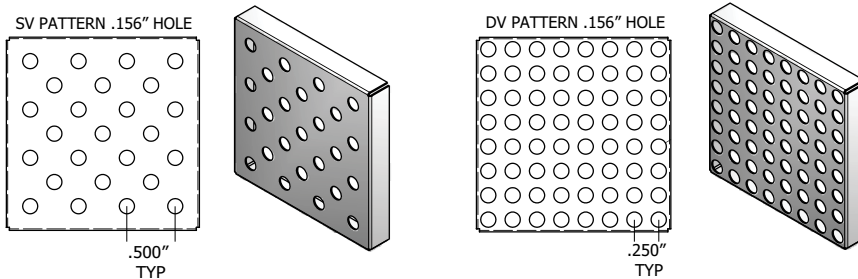


**CBS KE Series Configuration**



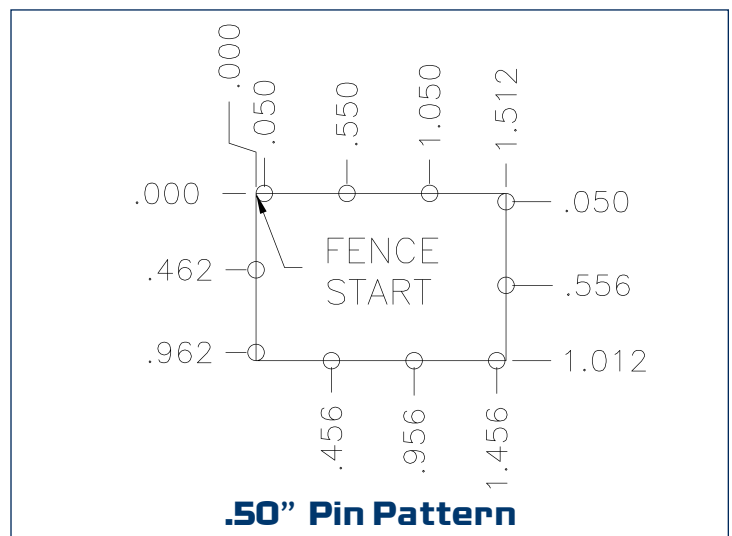
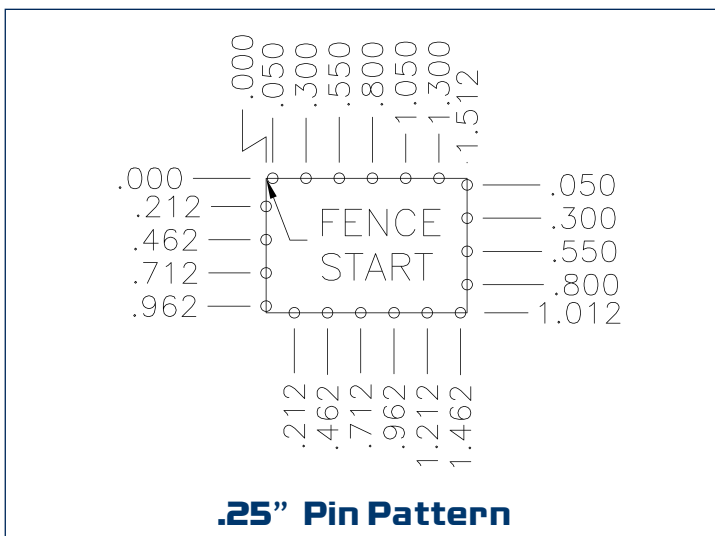
AVAILABLE HEIGHTS:  
 KE SERIES - .40" TO 2.0" (10,16 TO 50,8)  
 Recommended hole size: .050" (1,27)

**Ventilation Patterns**



Single density and double density ventilation holes available upon request.  
 SV/DV (Standard) = .156" dia. SV2/DV2 (Alternate) = .08" dia.

**Mounting Hole Patterns (KE Series)**



Pin pattern viewed from top of shield. Consult factory for pin patterns for your application

**KE Series Specs**

- Sizes:** .50" x .50" to 12" x 24" (.25" increments)
- Shapes:** Squares, rectangles and odd shapes in .25" increments
- Heights:** .40" to 2.00"
- Mounting Pins:** .25", .50" or 1.00" spacing
- Std Material:** .015" (.38) pre-tin plated steel
- Cover Retention:** 1.5 - 2.5 lb./linear inch
- Shielding Effectiveness:** up to 60 dB

**Standard Options**

- Formed fence and cover - unassembled (F)
- Assembled fence and cover (A)
- Flat fence and formed cover (U)
- Pre-tin plated Phos Bronze (P), Alloy 770 (N)
- Ventilation holes (SV 15% or DV 30%)
- Dimples for improved retention (D)

**Ordering a CBS is Easy**

1. Select your style number - "KE40-CBS"
2. Choose standard options listed above - "KE40-CBSFNSV"
3. Specify your width in .25" increments from .50" to 12.00" - "KE40-CBSFNSV-2.5"
4. Specify your length in .25" increments from .50" to 24.00" "KE40-CBSFNSV-2.5x4.5"
5. Specify your height from board to inside cover from .40" to 2.00" "KE40-CBSFNSV-2.5x4.5x.40"

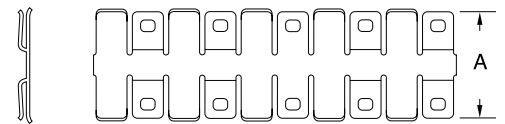


CBS2 Series		Black = inches Red = mm	
STYLE	FIG.	A HEIGHT	PACKAGE HEIGHT
CBS2	1	.800 (20,32)	.840 min. - 2.240 max (21,36 min. - 56,90 max)

NOTES: Drawing in Figure 1 is not to scale; see chart for sizing

**FIGURE 1**

CBS2: Specific packaging heights and relative PCB locations are obtained by adjusting individual cover heights.



## Engineered 6-sided Shield Enclosure

The versatile 6-sided CBS2 Shielding Box can be mounted on any side or orientation. We recommend the use of GRIP-SERT style threaded inserts. These inserts are completely threaded, enabling them to be utilized both as a method of exterior box attachment and for PCB attachment inside of the shielding box. This allows the use of CBS2 shielding boxes in a wide variety of unique mounting applications.

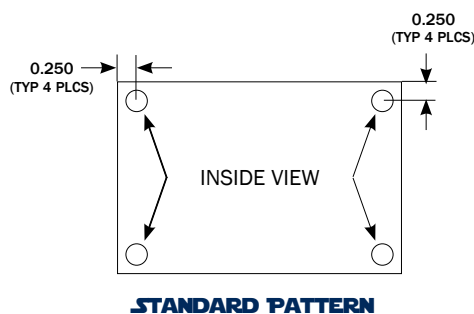
These highly versatile inserts deliver high torque-out resistance and high pull-out values in our standard .015" pre-tin plated steel or pre-tin plated Phos Bronze (P).

## Design

The Leader Tech CBS2 consists of the following:

- (1) fence using proven cover retention fingers on both sides
- (2) covers with height and features to be specified

### CBS2 Standoff Location



## CBS2 Series Specs

### Material Options

- Pre-tin plated steel
- Pre-tin plated Phos Bronze (P)
- Mu metal
- Alloy 770

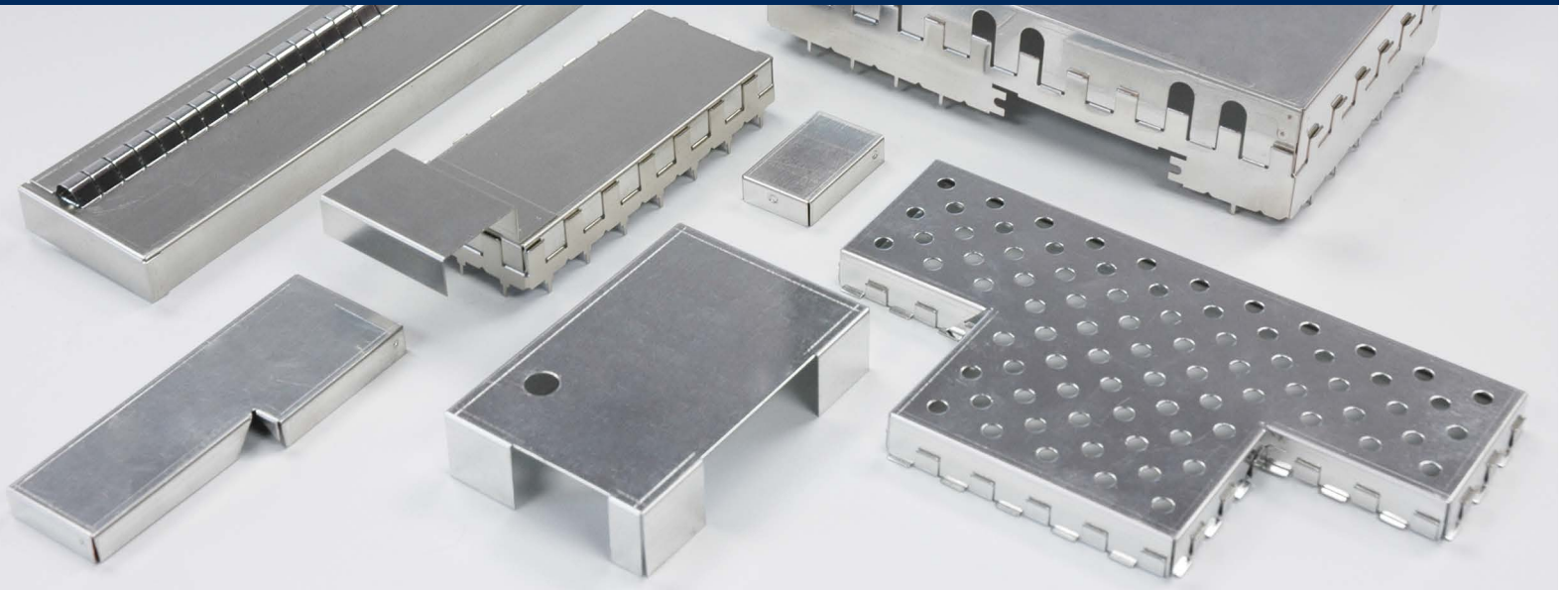
### Shapes

- Square
- Rectangle
- L-shape
- T-shape

### Optional Features

- I/O cutouts
- Mounting hardware for PCB
- Ventilation holes
- Locking dimples





## Standard Modifications Made Easy

Leader Tech understands that not all shielding applications can be satisfied with a standard CBS product. We also recognize that target budgets do not always accommodate a custom shielding solution. The Leader Tech Modified CBS gives you the flexibility to customize a standard CBS shield with significant savings compared to custom alternatives. Our Modified CBS products use existing tooling and manufacturing processes to give you a near-custom shielding solution at a fraction of the cost.

### Features/Benefits:

- Short lead time
- Little or no NRE required (tooling cost)
- Surface mount or through-hole design
- Unrestricted perimeter sizes
- Custom shapes to save space - rectangle, "T", "L", "Z"
- Multi-cavity design flexibility
- Multiple level design options
- Strong cover retention using patented Leader Tech "fingers"
- Removable cover for access to components
- Grounding gaskets
- I/O holes
- Trace notches
- Connector cutouts
- Enhanced shielding with RF absorbers
- ESD protection with insulator padding

### Modified CBS Specs

#### Material Options

- Alloy 770
- Pre-tin plated Phos Bronze
- Pre-tin plated steel

#### Plating Options

- Bright tin
- Matte tin
- Tin lead (not RoHS compliant)
- Nickel

#### Height Options

- .13" to 4.0"

#### Through-hole Mounting Pins

- .25", .50" & 1.0" spacing



## Multi-Cavity Shields Overview

As the complexity of a board's layout increases so does the need to maintain space, weight and cost control. To satisfy these demanding requirements, Leader Tech offers a cost-effective, multi-cavity version of its standard CBS product line.

Our proprietary multi-cavity manufacturing process gives engineers the flexibility to isolate multiple board-level components using the same shield. The near-custom product uses "off-the-shelf" components to create multiple internal cavities that share connecting walls and a single cover. This allows for a significant reduction in shield weight and allocated board space while maintaining tight cost controls.

In addition to unmatched performance, Leader Tech Multi-Cavity CBS shields also help reduce your final assembly cost and time-to-market. Our shields arrive ready to install for both through-hole and surface mount applications.

### Features/Benefits:

- Proven multi-cavity performance
- Minimal NRE
- Short lead time
- Nearly unlimited perimeter sizes
- Surface mount or through-hole design
- Mounting pins at .25", .50" or 1.0" spacing
- Shape possibilities- rectangle, "T", "L", "Z"
- Strong cover retention using patented Leader Tech retention "fingers"
- E-Z pull tabs for removal of cover and access to components
- Multiple level shields
- Welded partitions optional
- Semi-custom shield using standard off-the-shelf features
- Wide range of optional features based on CBS fences
- Reduced cost alternative vs. machined housings
- Consult factory for complete design assistance and engineering support

## Multi-Cavity Specs

### Material Options

- Alloy 770
- Pre-tin plated Phos Bronze
- Pre-tin plated steel

### Plating Options

- Bright tin
- Matte tin
- Tin lead (not RoHS compliant)
- Nickel

### Height Options

- .13" to 2.0"

## Overview

- The standard Leader Tech two-piece CBS consists of:
  - (1) Fence- wave, reflow or hand soldered to the PCB
  - (1) Cover- engages retention fingers on top edge of fence
- All dimensions are referenced from where the fence contacts the PCB
- Actual dimensions can be obtained from pin location pattern including material bend allowance (.006" per 90 degree corner in both X & Y axis)
- Recommended solder trace up to .100" wide
- It is advisable to verify pin location pattern with Leader Tech prior to manufacture of PCB to assure lowest cost solution for production of your Board Level Shield
- Pin location patterns provided on request for optimal PCB layout
- Available Materials include:
  - Pre-tin plated steel
  - Phosphorous bronze
  - Nickel silver alloy 770
- Custom shapes and multi-cavity layouts
- Applications engineers are available for design assistance

## Minimum Heights for Each Fence Series

- 10 SERIES = .130"(3,30)
- 20 SERIES = .200"(6,60)
- 40 SERIES = .400"(10,16)
- 50 SERIES = .500"(12,70)
- 80 SERIES = .800"(20,32)
- Height is measured from the top of the PCB to the underside of the cover
- Standard heights from .130"(3,3) to 2.00"(50,8)
- By simply changing the cover height, any desired overall height is achievable

## Overall Catalog Dimensions for Length and Width

- Standard sizes from .500"(12,7) x .500"(12,7) to 12.00"(304,8) x 24.00" (609,6)
- Minimum pin spacing of .250"(6,35) & minimum pad (surface mount) spacing .500"(12,7)
- Nominal catalog dimensions for length and width based on increments of .250"(6,35). Example: 21- CBSF- 1.25" x 2.75" x .225"
- Other sizes available, please consult a sales engineer for modified standard solutions
- All dimensions referenced here are nominal catalog dimensions

**Call your Leader Tech Applications Engineer or reference our web site for technical updates: [www.leadertechinc.com](http://www.leadertechinc.com)**

## Part Number Checklist

Height \_\_\_\_\_

Length \_\_\_\_\_

Width \_\_\_\_\_

### Pin spacing

- |                                |                                  |
|--------------------------------|----------------------------------|
| <input type="checkbox"/> 0.25" | <input type="checkbox"/> 0.50"   |
| <input type="checkbox"/> 1.0"  | <input type="checkbox"/> no pins |

### Pin length

- |                                |                                |
|--------------------------------|--------------------------------|
| <input type="checkbox"/> 0.05" | <input type="checkbox"/> 0.10" |
| <input type="checkbox"/> 0.12" | <input type="checkbox"/> 0.13" |
| <input type="checkbox"/> 0.15" |                                |

### Standoffs

- |                                 |                                |
|---------------------------------|--------------------------------|
| <input type="checkbox"/> 0.005" | <input type="checkbox"/> 0.01" |
| <input type="checkbox"/> 0.025" | <input type="checkbox"/> 0.05" |

### Fence series

- |                                |                               |
|--------------------------------|-------------------------------|
| <input type="checkbox"/> 10-20 | <input type="checkbox"/> 40   |
| <input type="checkbox"/> 50    | <input type="checkbox"/> 80   |
| <input type="checkbox"/> KE    | <input type="checkbox"/> CBS2 |

### Material

- |   |                                    |
|---|------------------------------------|
| <input type="checkbox"/> Pre-tin plated steel       | <input type="checkbox"/> Alloy 770 |
| <input type="checkbox"/> Pre-tin plated Phos Bronze |                                    |

### Plating

- |                                     |                                    |
|-------------------------------------|------------------------------------|
| <input type="checkbox"/> Bright tin | <input type="checkbox"/> Matte tin |
| <input type="checkbox"/> Nickel     | <input type="checkbox"/> Tin lead  |

### Ventilation holes

- |                                   |                                       |
|-----------------------------------|---------------------------------------|
| <input type="checkbox"/> Required | <input type="checkbox"/> Not required |
|-----------------------------------|---------------------------------------|

### Notches

- |                                   |                                       |
|-----------------------------------|---------------------------------------|
| <input type="checkbox"/> Required | <input type="checkbox"/> Not required |
|-----------------------------------|---------------------------------------|

### Access holes

- |                                   |                                       |
|-----------------------------------|---------------------------------------|
| <input type="checkbox"/> Required | <input type="checkbox"/> Not required |
|-----------------------------------|---------------------------------------|

### Locking dimples

- |                                   |                                       |
|-----------------------------------|---------------------------------------|
| <input type="checkbox"/> Required | <input type="checkbox"/> Not required |
|-----------------------------------|---------------------------------------|

### Multi-compartment

- |                                   |                                       |
|-----------------------------------|---------------------------------------|
| <input type="checkbox"/> Required | <input type="checkbox"/> Not required |
|-----------------------------------|---------------------------------------|



## Quick-Turn, Near Custom Shielding Solutions

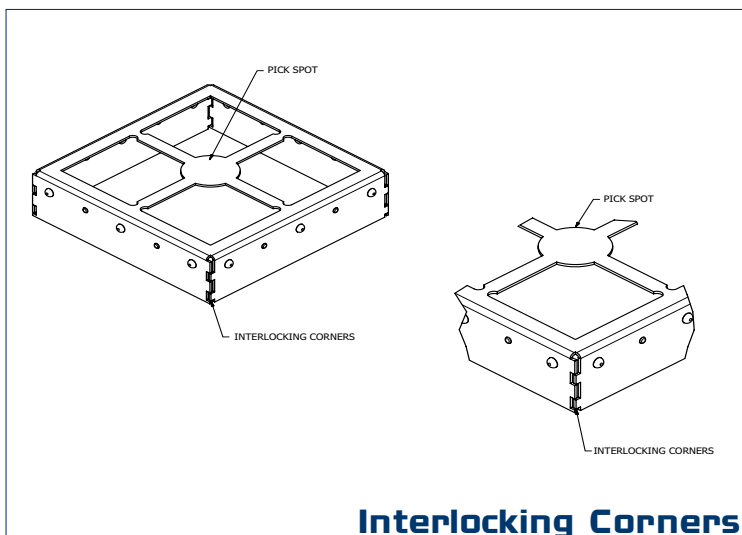
Slot-Lok™ shields from Leader Tech represent a proprietary manufacturing process that increases shield design flexibility while reducing lead time and total product cost. Slot-Lok™ Circuit Board Shields achieve this by applying standardized manufacturing methods to produce what would traditionally be a custom manufactured product. The proprietary Slot-Lok™ manufacturing process has helped many companies reduce their design-to-delivery time by a factor of four without incurring tooling charges.

An added feature of the Slot-Lok™ design is an audible click that confirms secure retention of the cover.

### A Slot-Lok™ Solution for any application

Slot-Lok™ .....	p.18
Slot-Lok™ Pro .....	p.19
Low Profile Slot-Lok™ .....	p.20
Multi-cavity Slot-Lok™ .....	p.21

## Slot-Lok™ with Interlocking Corners

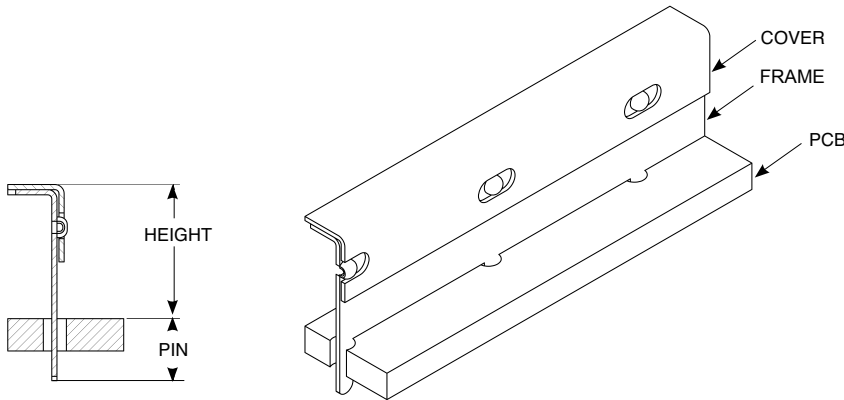


**Interlocking Corners**

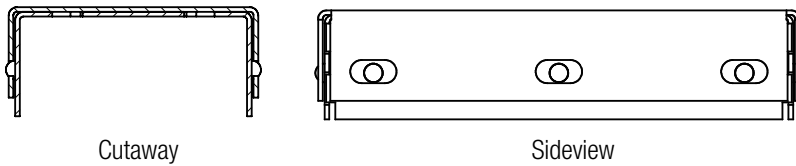
## Features and Benefits

- Lowest cost Slot-Lok™ design
- Shortest lead time
- Custom options available
- Through-hole or surface mount
- Locking & grounding dimples standard
- Automated pick & place option
- Tape & reel packaging option
- RoHS compliant
- Multiple finish plating options

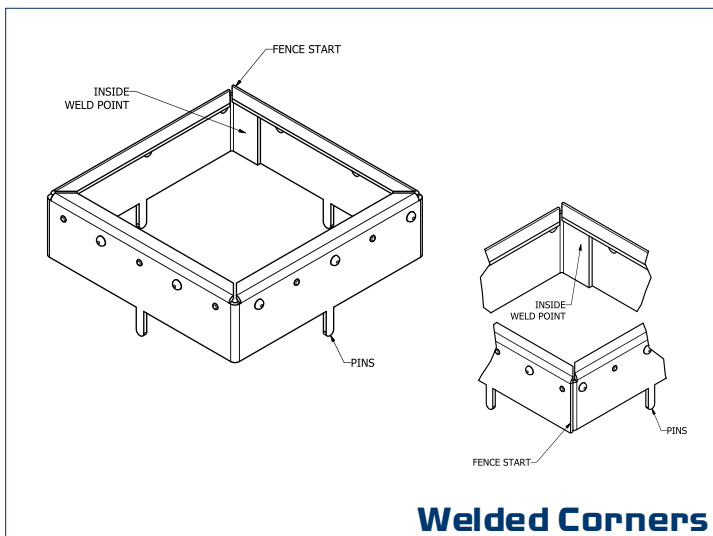
**Slot-Lok™ Configuration**



**Cutaway and Sideview**



**Slot-Lok™ Pro with Welded Corners**



**Welded Corners**

**Slot-Lok™ Series Specs**

**Sizes:** .50" x 12.00"

**Shapes:** Squares, Rectangles and Odd Shapes

**Heights:** <.150" to 2.00"

**Material Thickness:** .010" (.25), .012" (.31) or .015" (.38)

**Std Material:** Pre-tin plated steel  
Alloy 770 (Slot Lok™ Pro)

**Cover Retention:** 1.5 - 2.5 lb./linear inch

**Shielding Effectiveness:** up to 60 dB

**Standard Options**

- Unlimited board shield sizes
- Limitless pin spacing options
- Variety of cover retention methods
- Pull tabs for ease of cover removal
- Custom access holes and notches
- Ventilation holes for cover
- Multiple finish plating options

**Material Options**

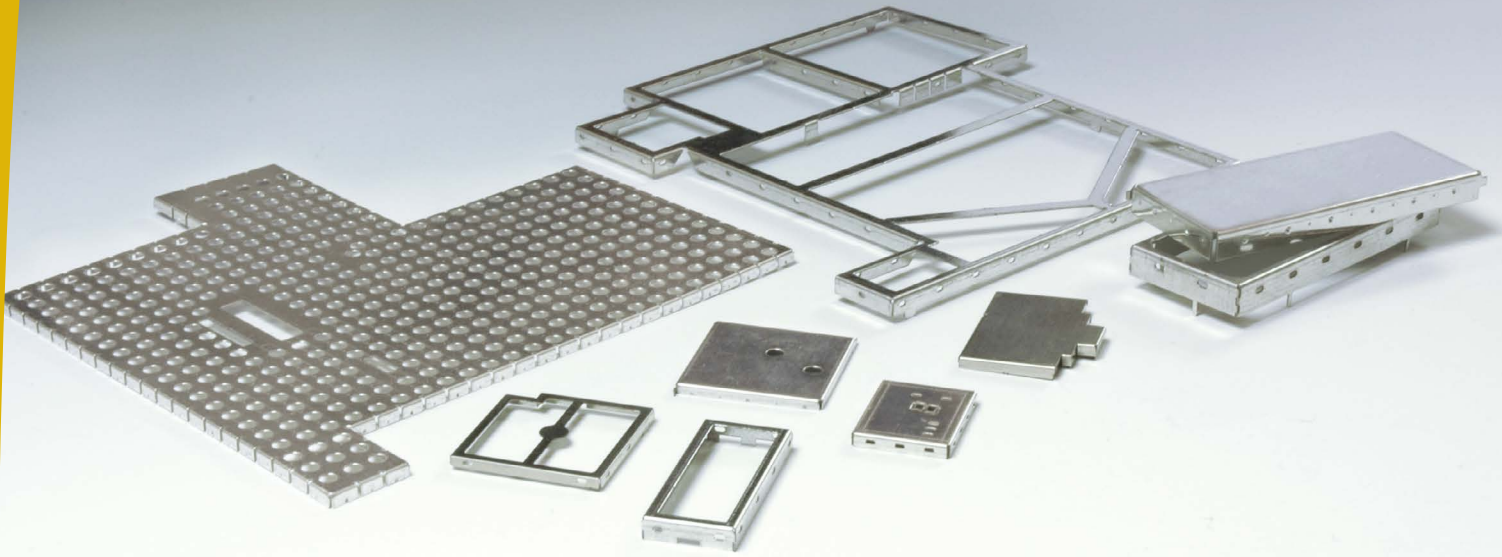
- Pre-tin plated Phos Bronze
- Brass
- BeCu

**Finish Plating Options**

- Bright tin
- Matte tin
- Tin lead (not RoHS compliant)
- Nickel

**Features and Benefits**

- No apertures for enhanced shielding performance
- Solid wall construction with welded corner
- Through-hole or surface mount
- Unlimited flexibility in size and shape
- Locking & grounding dimples standard
- Highly customizable platform
- Available in multi-cavity configurations
- RoHS compliant



## When space is tight...we've got you covered.

Leader Tech's Low Profile Slot-Lok™ design is the perfect choice for demanding applications that require a board-level shield, but have a stringent height requirement of less than .150".

This design variation offers all of the flexibility and benefits of the standard Slot-Lok™ series with a very compact profile. The shields are manufactured using RoHS compliant materials which exhibit exceptional solder characteristics, corrosion resistance and shielding effectiveness.

### Low Profile Slot-Lok™ Features and Benefits

- Low profile Slot-Lok™ design
- Short lead time
- Through-hole or surface mount
- Tape and reel packaging for automatic placement available
- Ideal for applications with height restrictions under .150"

*Slots on frame to accommodate lower profile*

### Low Profile Slot-Lok™ Specs

**Sizes:** .50" x 12.00"

**Shapes:** Squares, Rectangles and Odd Shapes

**Heights:** <.150" to 2.00"

**Material Thickness:** .010" (.25), .012" (.31) or .015" (.38)

**Std Material:** Pre-tin plated steel

**Cover Retention:** 1.5 - 2.5 lb./linear inch

**Shielding Effectiveness:** up to 60 dB

### Standard Options

- Unlimited board shield sizes
- Limitless pin spacing options
- Variety of cover retention methods
- Pull tabs for ease of cover removal
- Custom access holes and notches
- Ventilation holes for cover
- Multiple finish plating options

### Material Options

- Pre-tin plated Phos Bronze
- Alloy 770
- Brass
- BeCu

### Finish Plating Options

- Bright tin
- Matte tin
- Tin lead (not RoHS compliant)
- Nickel



## A Low-Cost, Multi-Cavity Alternative

The proprietary and extremely cost-effective Slot-Lok™ design and manufacturing process can accommodate virtually any multi-cavity shielding application requirement. This circuit board shield uses a flexible manufacturing technology that increases design options while reducing lead time and total product cost.

### Multi-Cavity Slot Lok™ Features and Benefits

- Minimal NRE
- Short lead time
- Surface mount or through-hole design
- Pin pitch matching - to replace existing "legacy" shields
- E-Z pull tabs for ease of cover removal
- Removable cover for access to components
- Cover retention using standard locking and grounding dimples
- Proven multi-cavity performance with interlocking corners
- Multiple level shields

### Multi-Cavity / Slot-Lok™ Specs

**Sizes:** .50" x 12.00"

**Shapes:** Squares, Rectangles and Odd Shapes

**Heights:** <.150" to 2.00"

**Material Thickness:** .010" (.25), .012" (.31) or .015" (.38)

**Std Material:** Alloy 770

**Cover Retention:** 1.5 - 2.5 lb./linear inch

**Shielding Effectiveness:** up to 60 dB

### Standard Options

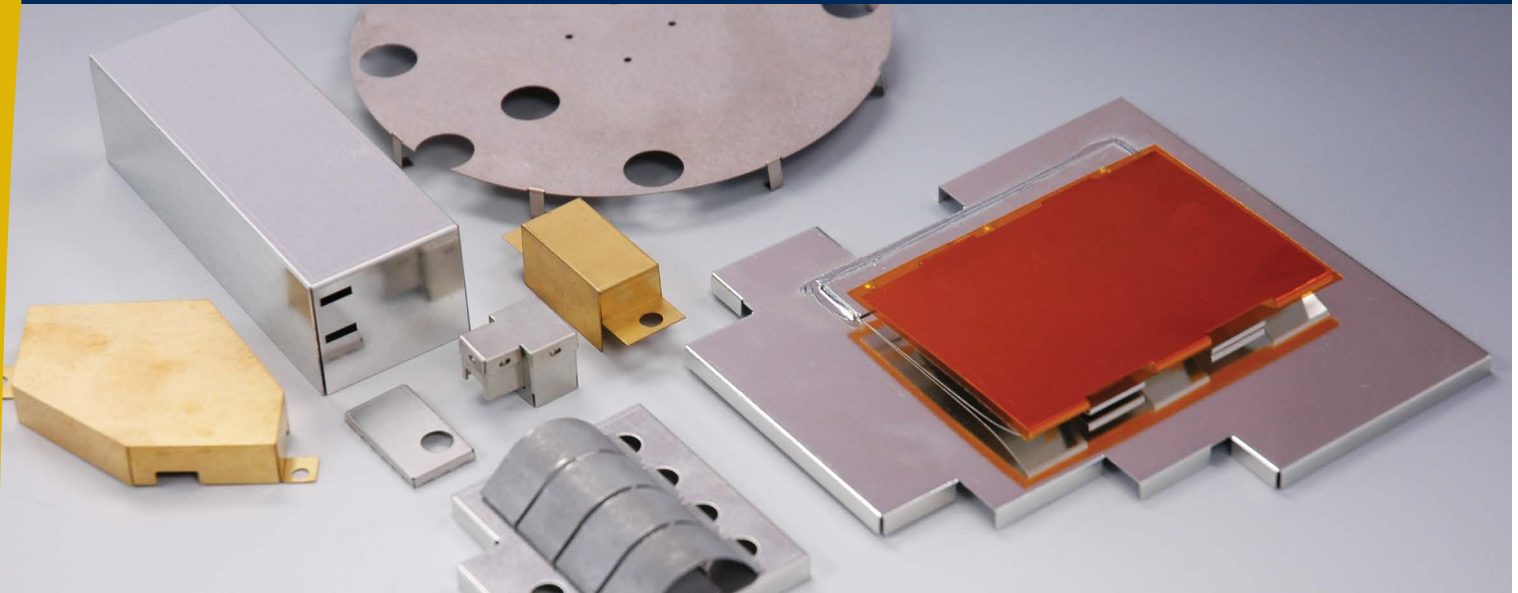
- Welded partitions
- Mouse holes, notches, ventilation, standoffs
- Welded fence assembly
- Pick & place spot
- Custom packaging: tape & reel, vacuum trays

### Material Options

- Pre-tin plated Phos Bronze
- Pre-tin plated steel

### Finish Plating Options

- Bright tin
- Matte tin
- Tin lead (not RoHS compliant)
- Nickel



## If you can describe it, we can make it! Customs are standard with Leader Tech.

Leader Tech is recognized as a world leader in the design and manufacturing of custom circuit board shields. Our comprehensive, consultative approach provides you with virtually limitless board-level shielding options. Our team involvement starts with your initial design concept and continues through 3D modeling, prototyping, testing, tooling and low- to high-volume manufacturing.

We are pioneers in the development of new and innovative manufacturing techniques and processes. By relying on Leader Tech's decades of experience, you can develop a custom shielding solution that is manufactured using proven, standardized methods- ultimately lowering your product cost while increasing your flexibility.

### The Ultimate Flexibility

- Unlimited shapes & sizes
- Unlimited material options
- Unlimited plating options
- Unlimited height- low to high
- One or two piece design
- Low volume prototype to high volume production
- Welding
- Soldering
- Combination shields
- Custom packaging
- Embossing

### Leader Tech Benefits

- Complete design assistance and 3D modeling services
- Engineering assistance on existing "legacy" shields
- Universal tooling and manufacturing experience
- Cost containment options
- Low- and high-volume product capabilities
- Industry-best lead time
- U.S.-based manufacturing

**ISO 9001: 2008**  
CERTIFIED





## Standard Packaging

All Leader Tech products are packaged and shipped direct from our Florida manufacturing facility. We hand pack all items to ensure the greatest product quality and the most economical shipping cost.

- Hand-packed foam liners with inner cardboard reinforcement- at no extra charge
- Bar coding on every package, including customer part number

## Optional Packaging

Leader Tech can accommodate virtually any packaging request. Some of the most common packaging requests include:

- Tape & Reel packaging
- Vacuum tray
- Customer-specified packaging

## Materials

Below is a list of the most common materials used by Leader Tech to manufacture standard, modified standard and custom circuit board shields.

### Tin Plated Steel

- Most cost effective option
- Most common material in PCB shielding
- Stocked thicknesses .008, .010, .012 & .015" (other thickness available)
- Bright tin and matte tin standard finish plating
- Highly solderable

### Nickel Silver Alloy 770

- Copper based alloy
- Common material used in PCB components
- Stocked thicknesses .008", .010", .012" & .015"
- Highly solderable
- High corrosion resistance

### Phosphorous Bronze

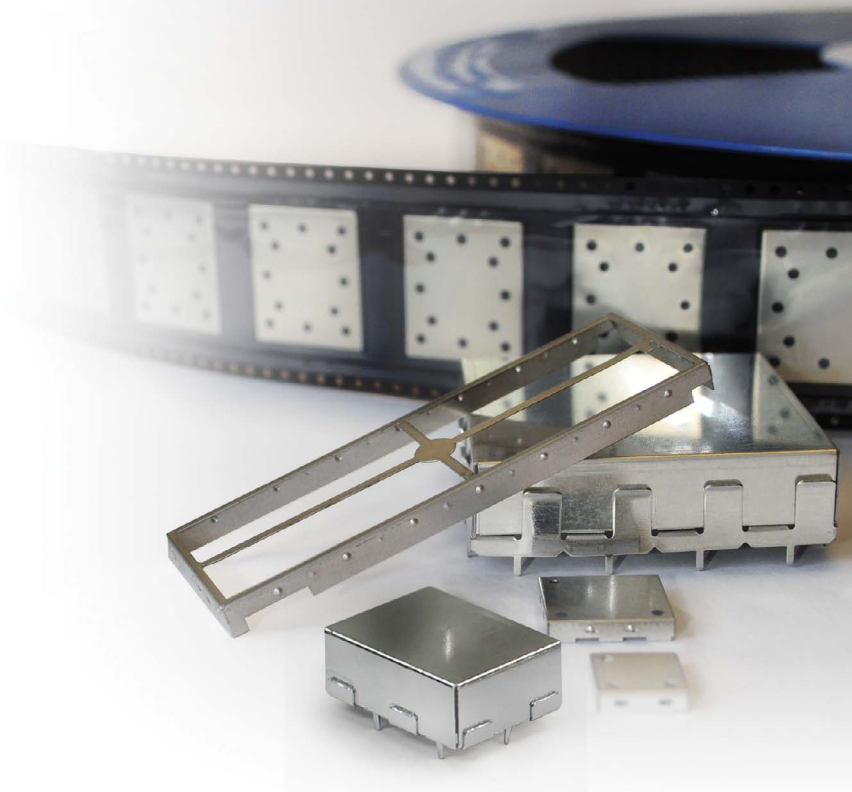
- Copper based alloy
- Non-magnetic applications
- Stocked thicknesses .010" & .015"
- Pre-tin plated and unplated available

### Mu Metal

- For use in low frequency applications
- Non-magnetic applications

### Other Materials Upon Request

- Copper
- Brass
- BeCu
- Stainless steel



# We've Got You Covered

*Reliable Board, Enclosure and Cable Shielding Solutions*

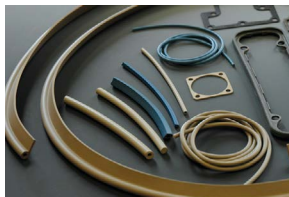
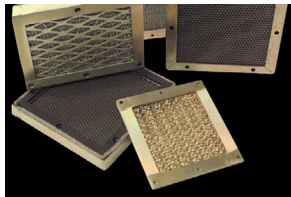
Leader Tech is a world-leading innovator and US-based manufacturer of EMI shielding products for circuit boards, enclosures and cables. In addition to our best selling standard, modified standard and custom CBS shields, Leader Tech offers an expansive line of beryllium copper fingerstock gaskets, conductive elastomers, advanced RF absorber materials and EMI/RFI ferrites.



EMI Enclosure Solutions Catalog

FerriShield Ferrite Catalog

EMI FSG Fabric Shielding Gasket Catalog



## LeaderTech Shielding Products

### Board Level Shielding

- Standard and Multi-Cavity CBS
- Modified Standard Options
- Custom Circuit Board Shields

### FerriShield Ferrites

- Snap-On Bisected & Solid Bead Ferrites
- Round & Flat Styles for Cables, Wires and Flex Circuits
- Low, High, Microwave and Wideband Frequency-Specific Material

### Enclosure Shielding

- BeCu Fingerstock Gaskets
- TechSIL 5000 Conductive Elastomers
- Conductive Fabric Shielding Gaskets
- TechSIL 8000 Oriented Wire Gaskets
- TechMESH Knitted Wire Gaskets
- TechMESH Combo Strip & Gaskets
- TechVent Honeycomb Shielding Panels

## EMI problem?

*Our sales engineers are waiting for your call: 866-TECH-EMI (866-832-4364)*

*Visit our web site today to browse our complete product line, download literature and find your local sales engineer or sales representative! [www.leadertechinc.com](http://www.leadertechinc.com)*

## Global EMI Shielding Technology Center

Leader Tech's Global EMI Shielding Technology Center located in Tampa, Florida is a one-of-a-kind, innovative manufacturing facility that delivers an unparalleled customer experience while satisfying growing demands for high-quality board, enclosure and cable shielding products.

Every detail of our ultra-modern facility is tailor-engineered to streamline and improve our customer interaction, engineering and manufacturing processes. The Shielding Technology Center encompasses all facets of the business including people, building size and equipment to dramatically improve productivity and capacity across all of our EMI shielding product lines.

From an enhanced engineering department to the optimized placement of every raw material and the deployment of custom designed manufacturing equipment, our facility is

uniquely positioned to capture an ever-increasing share of the custom and semi-custom segment within the shielding market.

In a time when companies are moving away from the EMI Shielding customer through offshore manufacturing and distribution channels, Leader Tech is committed to the US market by continuing to expand its industry experienced team, innovative manufacturing technology and US-based headquarters. As a core value of our company, Leader Tech believes that customers are better served when they are able to communicate directly with a live applications engineer instead of a machine or web site. Personalized and responsive support coupled with innovative domestic manufacturing have been and will continue to be the hallmark of Leader Tech's industry-best engineering and customer support departments.

### **You're Invited...**

*Consider it an open invitation to visit!*

As a current or prospective Leader Tech customer you are invited to our beautiful Tampa, Florida headquarters for a personal tour of our facility and manufacturing capabilities.

Please contact your regional sales engineer or our Tampa-based customer service department at 866.832.4364 or 813-855-6921.

**ISO 9001: 2008**  
CERTIFIED



## Leader Tech Modifiable Standard CBS Shields

Simply one of the best shields ever made. Our standard CBS products are at the top of the board-level shielding industry in performance, flexibility and value. The highly reliable 2-piece design (fence and cover) accommodates virtually any through-hole or surface mount application.

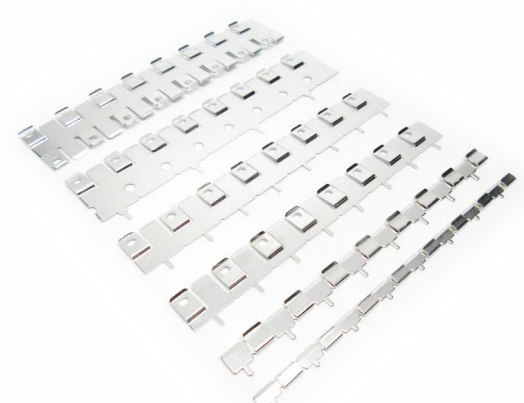


### CBS Features and Benefits

- 3 – 5 Day Lead time
- No tooling or NRE costs
- ¼" increment shield length and width
- Pin Spacing available in ¼", ½", 1"
- .015 Tin plated steel
- .015 Phosphor bronze Alloy 510
- .015 Nickel silver alloy 770
- Surface mount or through hole
- Low Piece Price
- Many sizes available with minimum heights as shown
  - 10 Series = .130" (3,30)
  - 20 Series = .200" (6,60)
  - 40 Series = .400" (10,16)
  - 50 Series = .500" (12,70)
  - 80 Series = .800" (20,32)
  - KE Series = .400" (10,16)  
= .500" (12,70)  
= .800" (20,32)
- Additional options available online

### CBS Part Number Builder

XX	-	CBS	X	X	X	X	-	XX	x	XX	x	XXX		
Select a CBS Series #			Assembly Options	Material	Vent Hole Options		Dimples			Shield Width (.25" increment)		Shield Length (.25" increment)		Undercover Height
			<b>F</b> Formed Fence & Cover <b>Unassembled</b>	<b>Leave Blank</b>	.015" thick Tin Plated Steel	<b>Leave Blank</b>	No Vent Holes Required	<b>Leave Blank</b>	No Dimples Required					
			<b>A</b> Formed Fence & Cover <b>Assembled</b>	<b>N</b>	.015" thick Alloy 770	<b>SV</b>	0.156" Single Vent Hole Pattern (15%)	<b>D</b>	Dimples Required (40, 50, 80, KE Series)					
			<b>U</b> Flat Fence & Formed Cover	<b>P</b>	.015" thick Tin Plated Phos. Bronze	<b>SV2</b>	0.080" Single Vent Hole Pattern							
						<b>SV3</b>	0.118" Single Vent Hole Pattern							
						<b>DV</b>	0.156" Double Vent Hole Pattern (30%)							
						<b>DV2</b>	0.080" Double Vent Hole Pattern							
						<b>DV3</b>	0.118" Double Vent Hole Pattern							



### Part Number Examples

**Standard Example:**  
54-CBSF-1.5x2.5x0.5

**Example with Alloy 770 & SV Vent Holes:**  
54-CBSFNSV-1.5x2.5x0.5

# CBS **CIRCUIT BOARD SHIELDING**

STANDARDS • MODIFIED STANDARDS • CUSTOMS

*A passion in all we do*

**LEADER  
TECH**   
a HEICO company

12420 Race Track Road Tampa, Florida 33626

[www.leadertechinc.com](http://www.leadertechinc.com) • [sales@leadertechinc.com](mailto:sales@leadertechinc.com)

866.TECH.EMI (866.832.4364) • Local: 813-855-6921 • Fax: (813) 855-3291

ISO 9001: 2008  
CERTIFIED



## X-ON Electronics

Largest Supplier of Electrical and Electronic Components

*Click to view similar products for [EMI Gaskets, Sheets, Absorbers & Shielding](#) category:*

*Click to view products by [LeaderTech](#) manufacturer:*

Other Similar products are found below :

[8101010140](#) [1194-14"X36YD](#) [1194-7.7X10](#) [1245-34"X18YD](#) [1267](#) [1345-3/8x18yrd](#) [1380-2"X8"](#) [1554907-1](#) [2320002000](#) [2320014700](#)  
[SG293037DS](#) [ST005PCN50](#) [3070-500-STD](#) [46739-24](#) [55005107](#) [38M4040AA0606](#) [1125-8X10](#) [1126X1"](#) [1170-3/4X18YDS](#) [1170-7.7x10](#)  
[1183-12"X18YD](#) [6-34T-BD-0.315](#) [SG125187D-24](#) [SG125250R-24](#) [SG187375R-24](#) [SG284050DS](#) [KIT TECH CLIP](#) [10-40450-28S](#) [1245](#)  
[1267-1/2"x18yd](#) [46J8501020.NN00](#) [1170-1/4"x18yd](#) [AL-36FR-1x54.5](#) [3013310A](#) [1194X1"](#) [3020604](#) [3021302](#) [3020705](#) [3031313](#) [260709](#)  
[3021310](#) [6-34UT-070-BD-16](#) [303076048](#) [3070-500-RUB](#) [46J5N03020.NN00](#) [30206025](#) [30395641](#) [3030403](#) [3690103020](#) [HNY-](#)  
[LT15CU4241](#)