

LuxiGen™ Multi-Color Emitter Series
LZ4 RGBW Power
High Current RGBW Flat Lens Emitter

LZ4-04MDPB

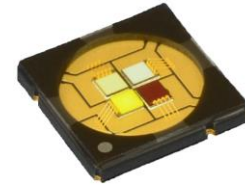

Key Features

- Highest flux density surface mount ceramic RGBW LED with integrated flat glass lens
- 40W power dissipation in a small 7.0mm x 7.0mm emitter footprint
- Compact 2.15mm x 2.15mm Light Emitting Area and low profile package maximize coupling efficiency into secondary optics
- Thermal resistance of 0.9°C/W; up to 3.0A maximum drive current per die
- Individually addressable Red, Green, Blue and Daylight White die
- Electrically neutral thermal path
- JEDEC Level 1 for Moisture Sensitivity Level
- Lead (Pb) free and RoHS compliant

Typical Applications

- Stage and Studio Lighting
- Effect Lighting
- Accent Lighting
- Display Lighting
- Architectural Lighting

Description

The 40W LZ4 RGBW Power emitter produces a full spectrum of brilliant colors with the highest flux density by allowing each die to be driven at up to 3.0A. Through its compact 2.15mm x 2.15mm Light Emitting Area, it delivers more than double the light, doubling the punch from the same fixture utilizing previous generation 4-die RGBW emitters. Utilizing a lower profile substrate and a thinner flat glass lens than its predecessor, the emitter allows the secondary optics to be closer to the die, maximizing the coupling efficiency into the zoom optics, mixing rods, light pipes and other optics. The high quality materials used in the package are chosen to maximize light output and minimize stresses which results in monumental reliability and lumen maintenance.

Part number options

Base part number

Part number	Description
LZ4-04MDPB-0000	LZ4 RGBW Power
LZ4-V4MDPB-0000	LZ4 RGBW Power on Standard Star 4 channel MCPCB

Bin kit option codes

MD, Red-Green-Blue-White (6500K)			
Kit number suffix	Min flux Bin	Color Bin Ranges	Description
0000	09R	R01	Red, full distribution flux; full distribution wavelength
	23G	G04-G05	Green, full distribution flux; full distribution wavelength
	19B	B05-B08	Blue, full distribution flux; full distribution wavelength
	13W	1V2U	White full distribution flux and CCT

Daylight White Chromaticity Groups

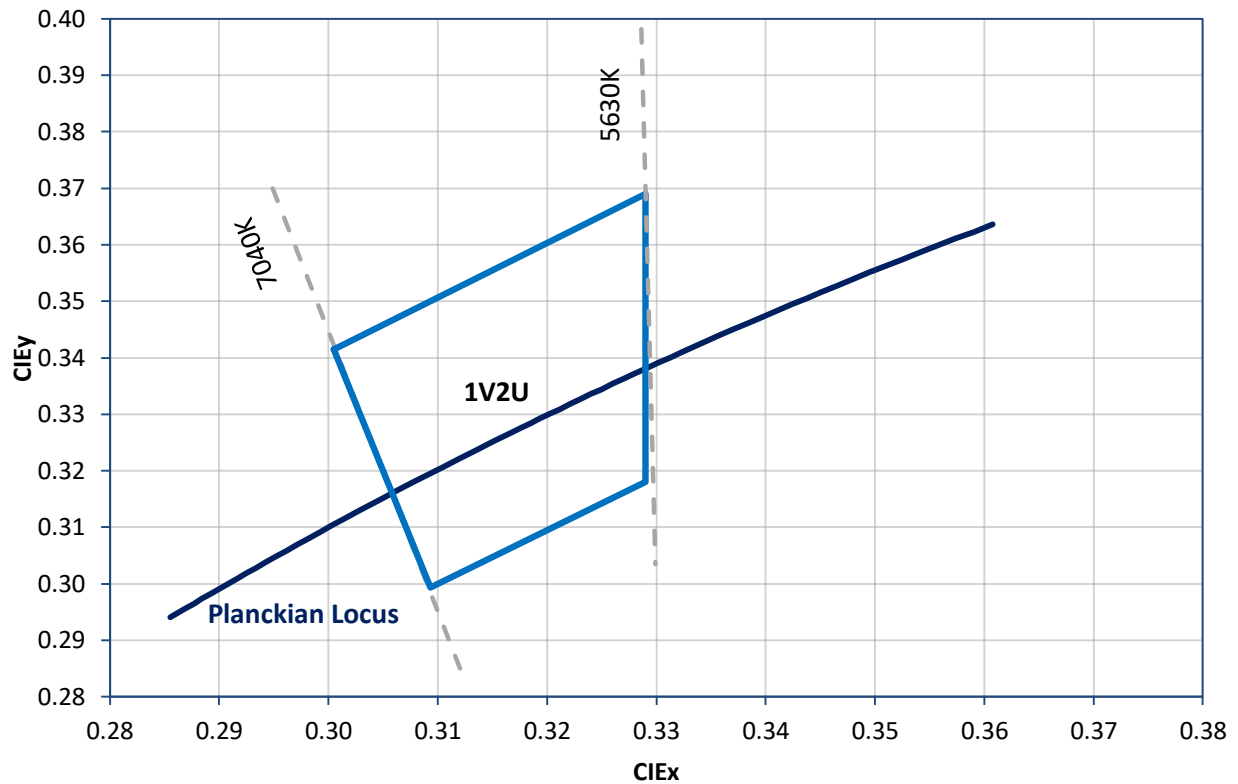

Standard Chromaticity Groups plotted on excerpt from the CIE 1931 (2°) x-y Chromaticity Diagram. Coordinates are listed below.

Daylight White Bin Coordinates

Bin Code	CIE _x	CIE _y
1V2U	0.3005	0.3415
	0.329	0.369
	0.329	0.318
	0.3093	0.2993
	0.3005	0.3415

Flux Bins

Table 1:

Bin Code	Minimum Flux (Φ) @ $I_F = 1000\text{mA}^{[1]}$				Maximum Flux (Φ) @ $I_F = 1000\text{mA}^{[1]}$			
	Luminous Flux (lm)	Luminous Flux (lm)	Radiant Flux (W)	Luminous Flux (lm)	Luminous Flux (lm)	Luminous Flux (lm)	Radiant Flux (W)	Luminous Flux (lm)
	Red	Green	Blue	White	Red	Green	Blue	White
09R	90				140			
23G		160				280		
19B			1.0				1.5	
13W				235				360

Notes for Table 1:

- Flux performance is measured at 10ms pulse, $T_c=25^\circ\text{C}$. LED Engin maintains a tolerance of $\pm 10\%$ on flux measurements.

Dominant Wavelength Bins

Table 2:

Bin Code	Minimum Dominant Wavelength (λ_D) @ $I_F = 1000\text{mA}^{[1]}$ (nm)			Maximum Dominant Wavelength (λ_D) @ $I_F = 1000\text{mA}^{[1]}$ (nm)		
	Red	Green	Blue	Red	Green	Blue
	R01	617			630	
G04		519			525	
G05		525			531	
B05			449			453
B08			453			458

Notes for Table 2:

- Dominant wavelength is measured at 10ms pulse, $T_c=25^\circ\text{C}$. LED Engin maintains a tolerance of $\pm 1.0\text{nm}$ on dominant wavelength measurements.

Forward Voltage Bin

Table 3:

Bin Code	Minimum Forward Voltage (V_F) @ $I_F = 1000\text{mA}^{[1]}$ (V)				Maximum Forward Voltage (V_F) @ $I_F = 1000\text{mA}^{[1]}$ (V)			
	Red	Green	Blue	White	Red	Green	Blue	White
	0	1.8	3.0	2.7	2.7	2.8	4.1	3.4

Notes for Table 3:

- Forward voltage is measured at 10ms pulse, $T_c=25^\circ\text{C}$. LED Engin maintains a tolerance of $\pm 0.04\text{V}$ on forward voltage measurements.

Absolute Maximum Ratings

Table 4:

Parameter	Symbol	Value	Unit
DC Forward Current - Red ^[1]	I_F	2500	mA
DC Forward Current – Green, Blue, White ^[1]	I_F	3000	mA
Peak Pulsed Forward Current ^[2]	I_{FP}	3000	mA
Reverse Voltage	V_R	See Note 3	V
Storage Temperature	T_{std}	-40 ~ +150	°C
Junction Temperature	T_J	125	°C
Soldering Temperature ^[4]	T_{sol}	260	°C

Notes for Table 4:

- Maximum DC forward current is determined by the overall thermal resistance and ambient temperature. Follow the curves in Figure 11 for current derating.
- Pulse forward current conditions: Pulse Width \leq 10msec and Duty Cycle \leq 10%.
- LEDs are not designed to be reversing biased.
- Solder conditions per JEDEC 020D. See Reflow Soldering Profile Figure 4.
- LED Engin recommends taking reasonable precautions towards possible ESD damages and handling the emitter in an electrostatic protected area (EPA). An EPA may be adequately protected by ESD controls as outlined in ANSI/ESD S6.1.

Optical Characteristics @ $T_C = 25^\circ\text{C}$

Table 5:

Parameter	Symbol	Typical				Unit
		Red	Green	Blue ^[1]	White	
Luminous Flux (@ $I_F = 1000\text{mA}$)	Φ_V	105	200	35	280	lm
Luminous Flux (@ $I_F = 2500\text{mA}$)	Φ_V	240	350	70	560	lm
Luminous Flux (@ $I_F = 3000\text{mA}$)	Φ_V	-	380	82	630	lm
Radiant Flux (@ $I_F = 1000\text{mA}$)	Φ			1.2		W
Radiant Flux (@ $I_F = 2500\text{mA}$)	Φ			2.4		W
Radiant Flux (@ $I_F = 3000\text{mA}$)	Φ			2.8		W
Dominant Wavelength	λ_D	623	523	451		
Correlated Color Temperature	CCT				6500	K
Color Rendering Index (CRI)	R_a				75	
Viewing Angle ^[2]	$2\Theta_{\frac{1}{2}}$		110			
Total Included Angle ^[3]	$\Theta_{0.9}$		150			Degrees

Notes for Table 5:

- When operating the Blue LED, observe IEC 60825-1 class 2 rating. Do not stare into the beam.
- Viewing Angle is the off axis angle from emitter centerline where the luminous intensity is $\frac{1}{2}$ of the peak value.
- Total Included Angle is the total angle that includes 90% of the total luminous flux.

Electrical Characteristics @ $T_C = 25^\circ\text{C}$

Table 6:

Parameter	Symbol	Typical				Unit
		Red	Green	Blue	White	
Forward Voltage (@ $I_F = 1000\text{mA}$)	V_F	2.4	3.5	3.0	3.0	V
Temperature Coefficient of Forward Voltage	$\Delta V_F / \Delta T_J$	-1.9	-4.2	-1.8	-1.8	mV/°C
Thermal Resistance (@ $I_F = 1000\text{mA}$) (Junction to Case)	RO_{J-C}		0.9			°C/W
Thermal Resistance (@ $I_F = 3000\text{mA}$) (Junction to Case)	RO_{J-C}		1.5			°C/W

IPC/JEDEC Moisture Sensitivity Level

Table 7 - IPC/JEDEC J-STD-20D.1 MSL Classification:

Level	Floor Life		Soak Requirements			
	Time	Conditions	Standard	Accelerated	Standard	Accelerated
	Time	Conditions	Time (hrs)	Conditions	Time (hrs)	Conditions
1	Unlimited	≤ 30°C/ 85% RH	168 +5/-0	85°C/ 85% RH	n/a	n/a

Notes for Table 7:

- The standard soak time includes a default value of 24 hours for semiconductor manufacturer's exposure time (MET) between bake and bag and includes the maximum time allowed out of the bag at the distributor's facility.

Average Lumen Maintenance Projections

Lumen maintenance generally describes the ability of a lamp to retain its output over time. The useful lifetime for solid state lighting devices (Power LEDs) is also defined as Lumen Maintenance, with the percentage of the original light output remaining at a defined time period.

Based on long-term HTOL testing, LED Engin projects that LZ4-04MDPB will deliver, on average, 70% Lumen Maintenance at 20,000 hours of operation at a forward current of 2.5A for Red, 3.0A for Green, Blue and White. This projection is based on constant current operation with junction temperature maintained at or below 125°C.

Mechanical Dimensions (mm)

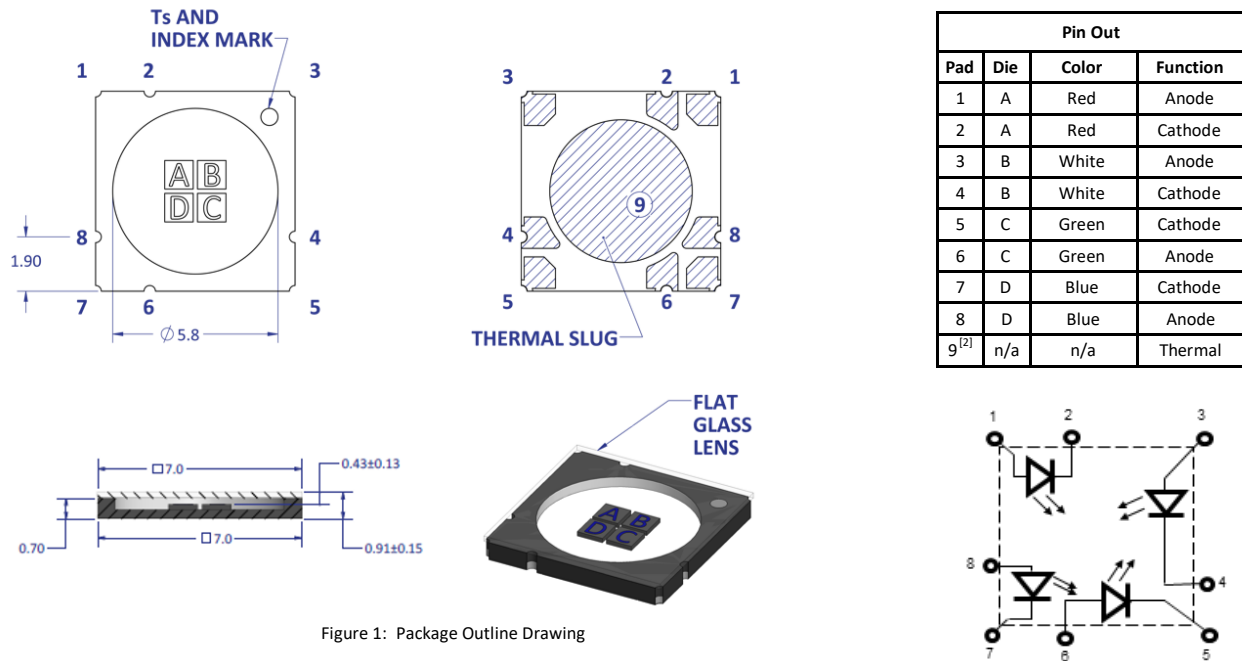

Figure 1: Package Outline Drawing

Notes for Figure 1:

1. Unless otherwise noted, the tolerance = ± 0.20 mm.
2. Nominal die spacing is 0.15mm.
3. Thermal contact, Pad 9, is electrically neutral.

Recommended Solder Pad Layout (mm)

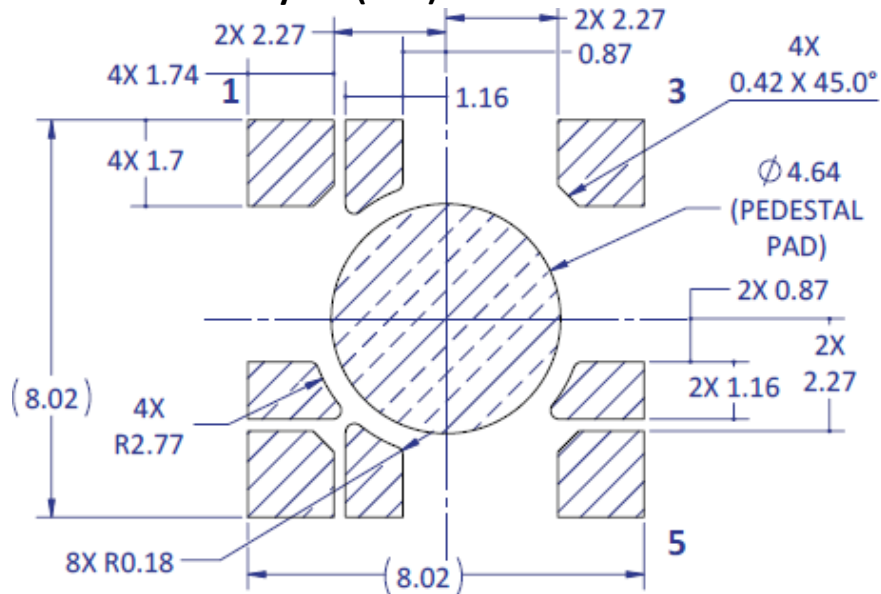

Figure 2a: Recommended solder pad layout for anode, cathode, and thermal pad.

Note for Figure 2a:

1. Unless otherwise noted, the tolerance = ± 0.20 mm.
2. Pedestal MCPCB allows the emitter thermal slug to be soldered directly to the metal core of the MCPCB. Such MCPCB eliminate the high thermal resistance dielectric layer that standard MCPCB technologies use in between the emitter thermal slug and the metal core of the MCPCB, thus lowering the overall system thermal resistance.
3. LED Engin recommends x-ray sample monitoring for solder voids underneath the emitter thermal slug. The total area covered by solder voids should be less than 20% of the total emitter thermal slug area. Excessive solder voids will increase the emitter to MCPCB thermal resistance and may lead to higher failure rates due to thermal over stress.

Reflow Soldering Profile



Figure 3: Reflow soldering profile for lead free soldering

Typical Radiation Pattern

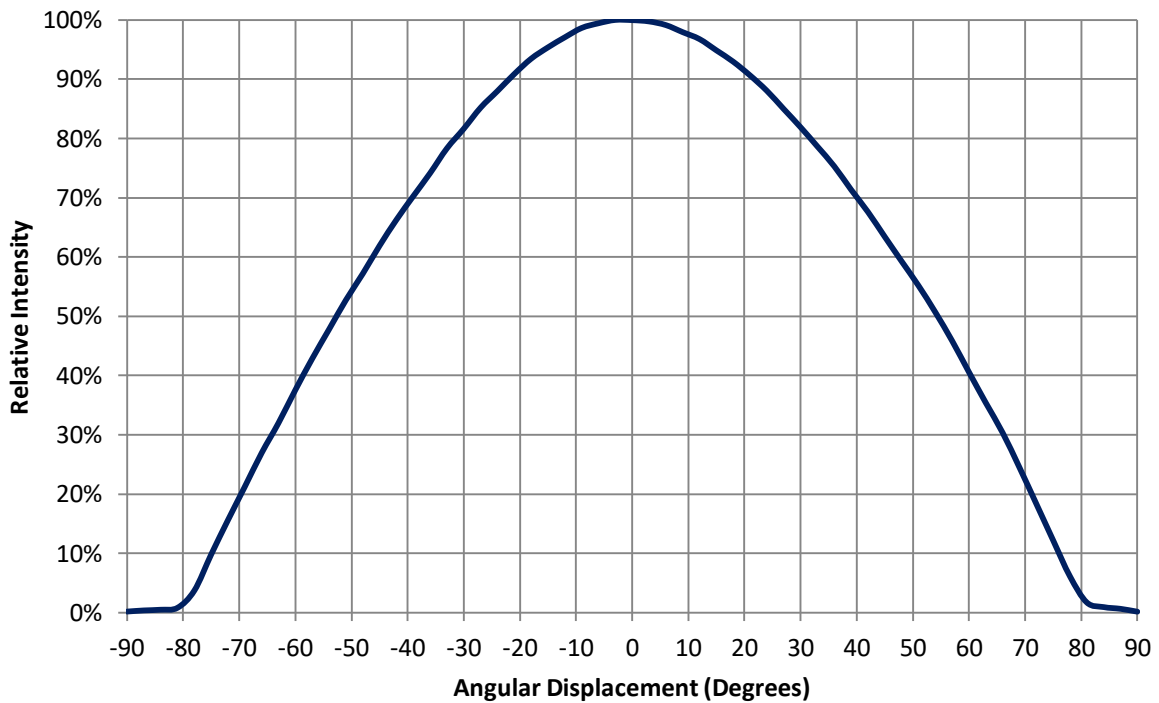

Figure 4: Typical representative spatial radiation pattern

Typical Relative Spectral Power Distribution

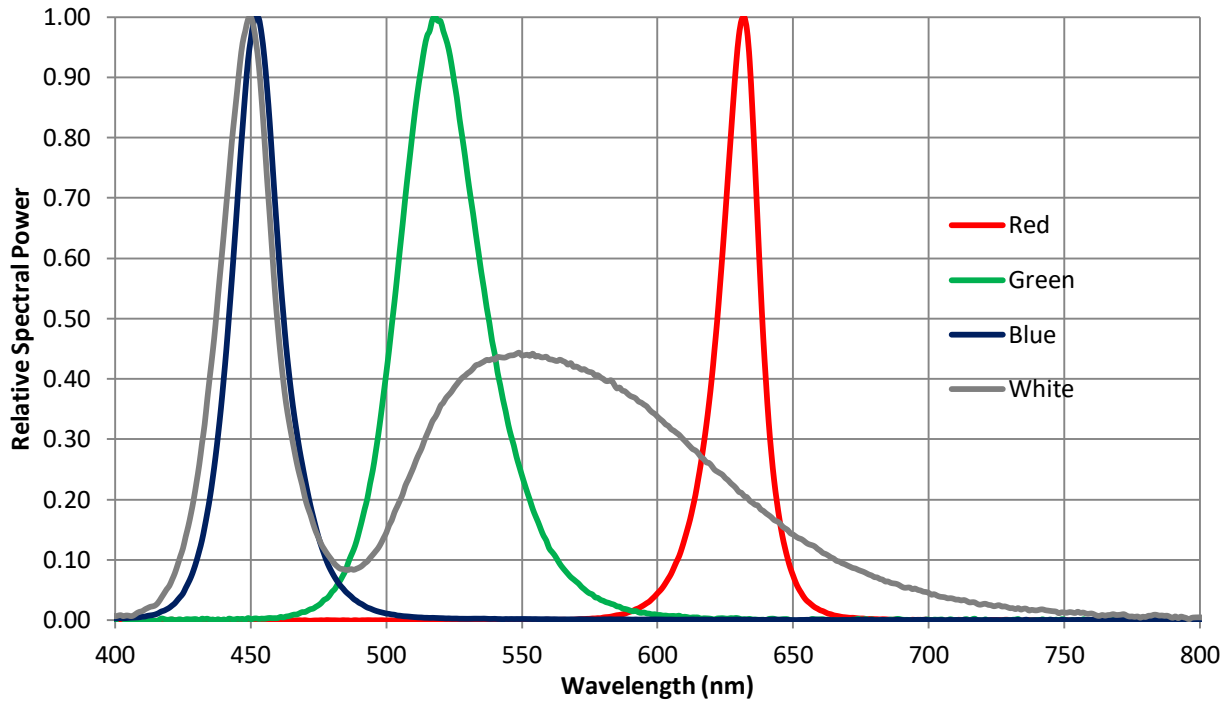

Figure 5: Typical relative spectral power vs. wavelength @ T_c = 25°C.

Typical Forward Current Characteristics

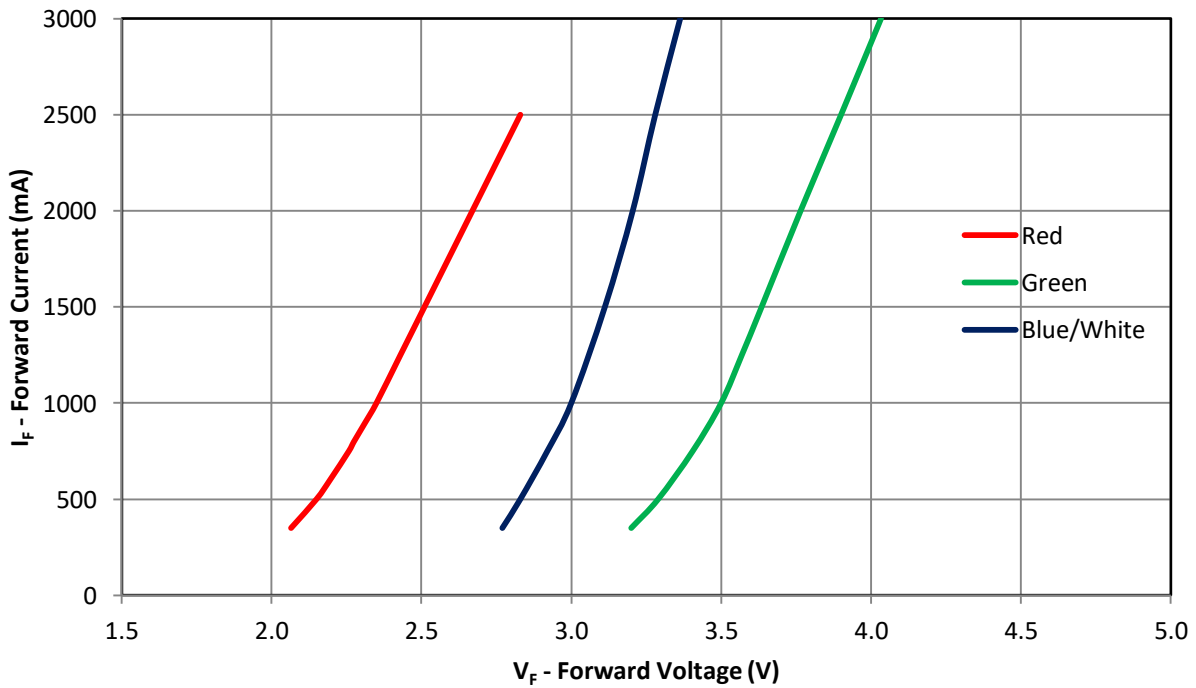

Figure 6: Typical forward current vs. forward voltage @ T_c = 25°C

Typical Relative Light Output over Current

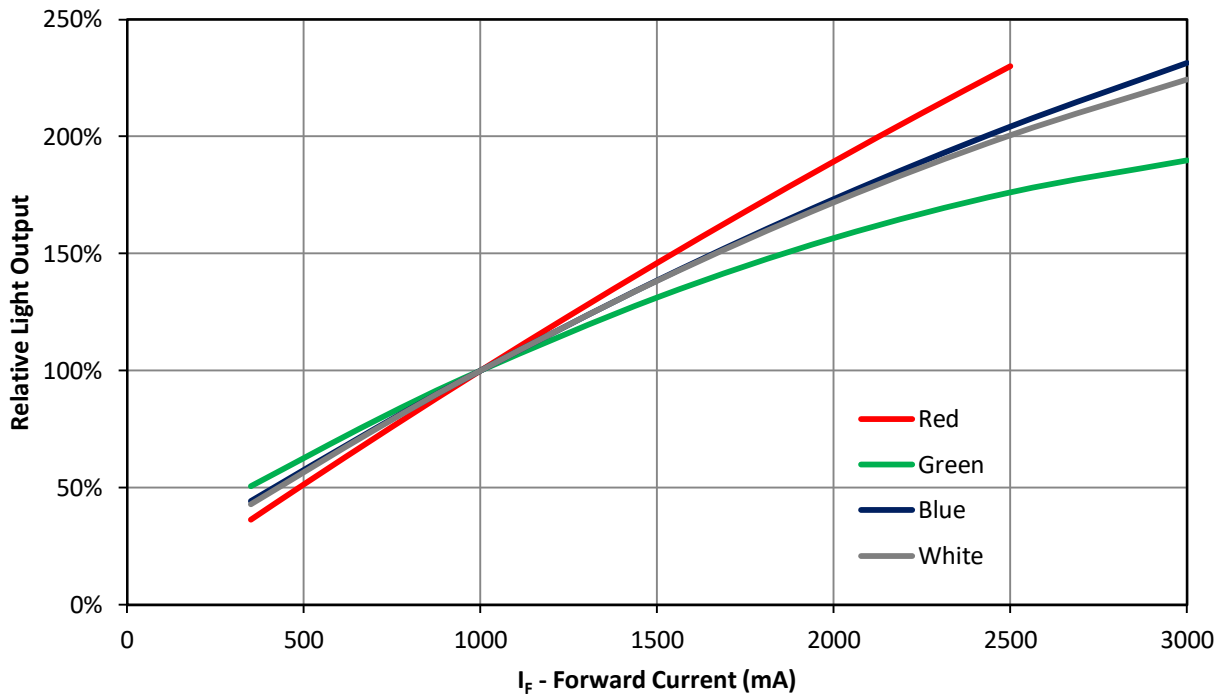

Figure 7: Typical relative light output vs. forward current @ T_c = 25°C

Typical Relative Light Output over Temperature

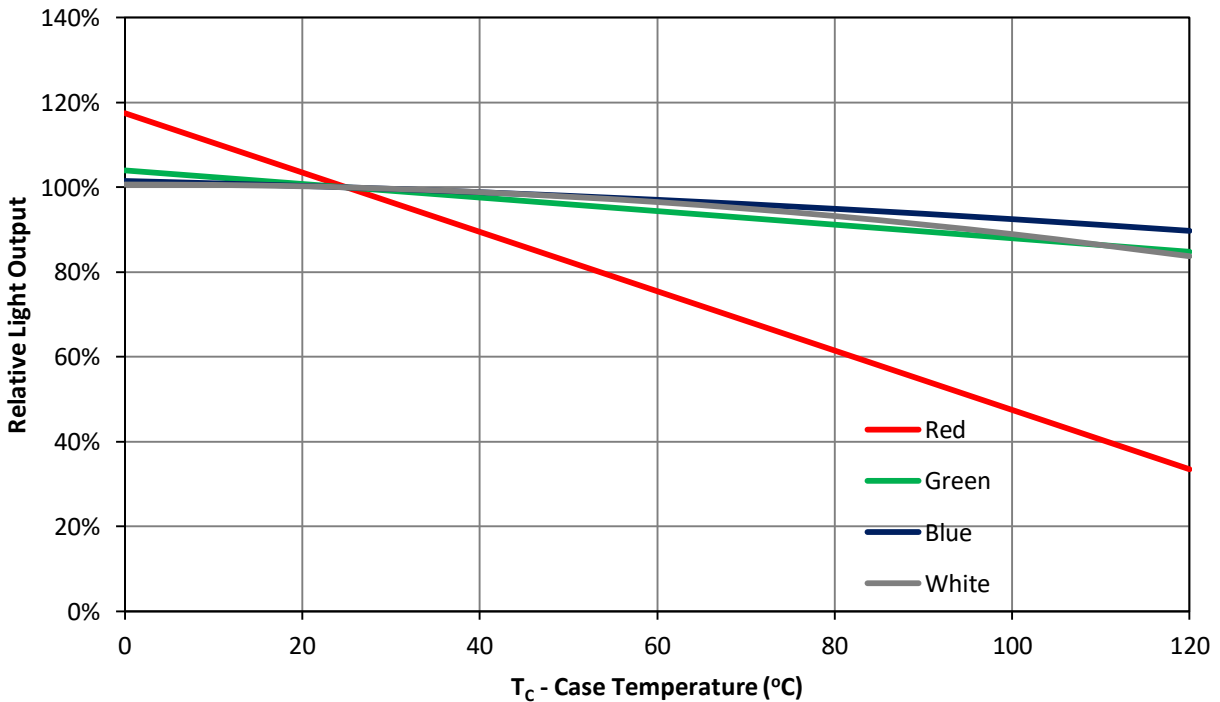

Figure 8: Typical relative light output vs. case temperature.

Typical Dominant Wavelength/Chromaticity Coordinate Shift over Current

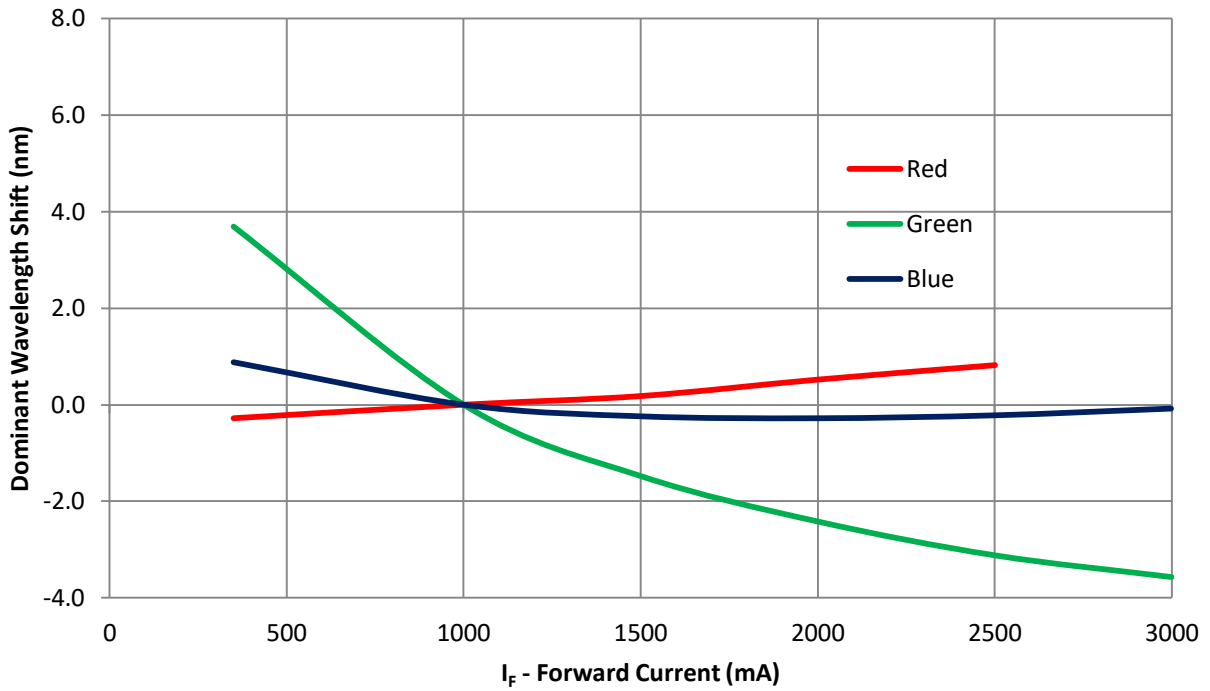

Figure 9a: Typical dominant wavelength shift vs. forward current @ $T_c = 25^\circ\text{C}$.

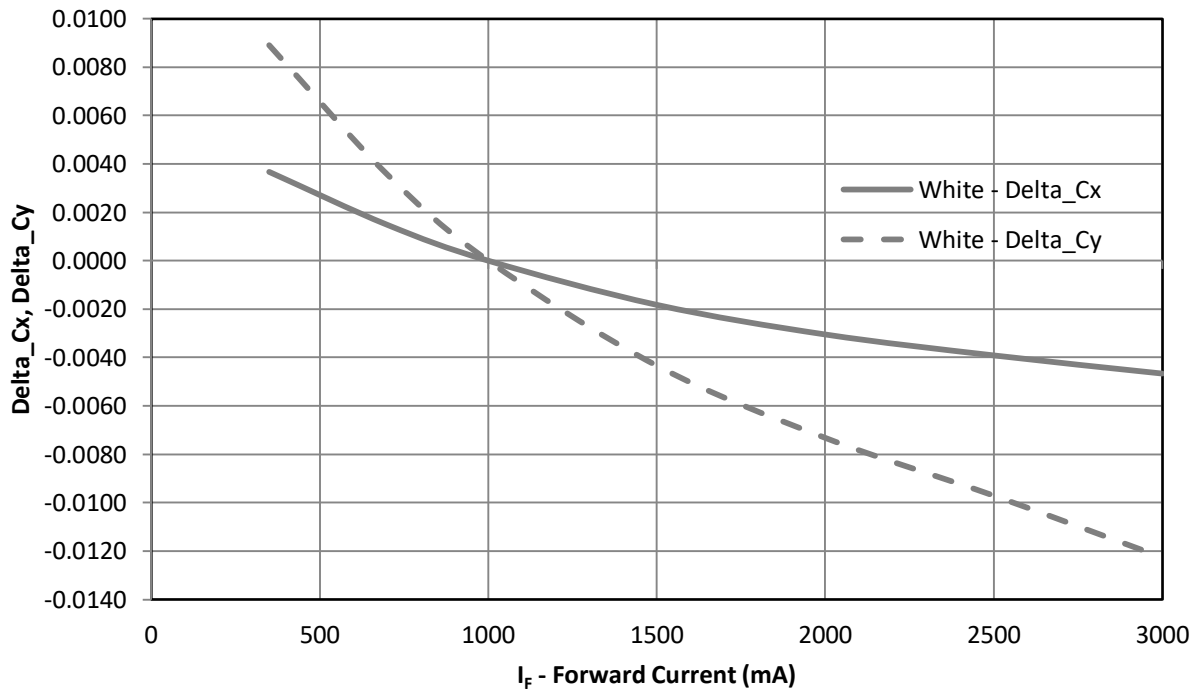

Figure 9b: Typical chromaticity coordinate shift vs. forward current @ $T_c = 25^\circ\text{C}$.

Typical Dominant Wavelength/Chromaticity Coordinate Shift over Temperature

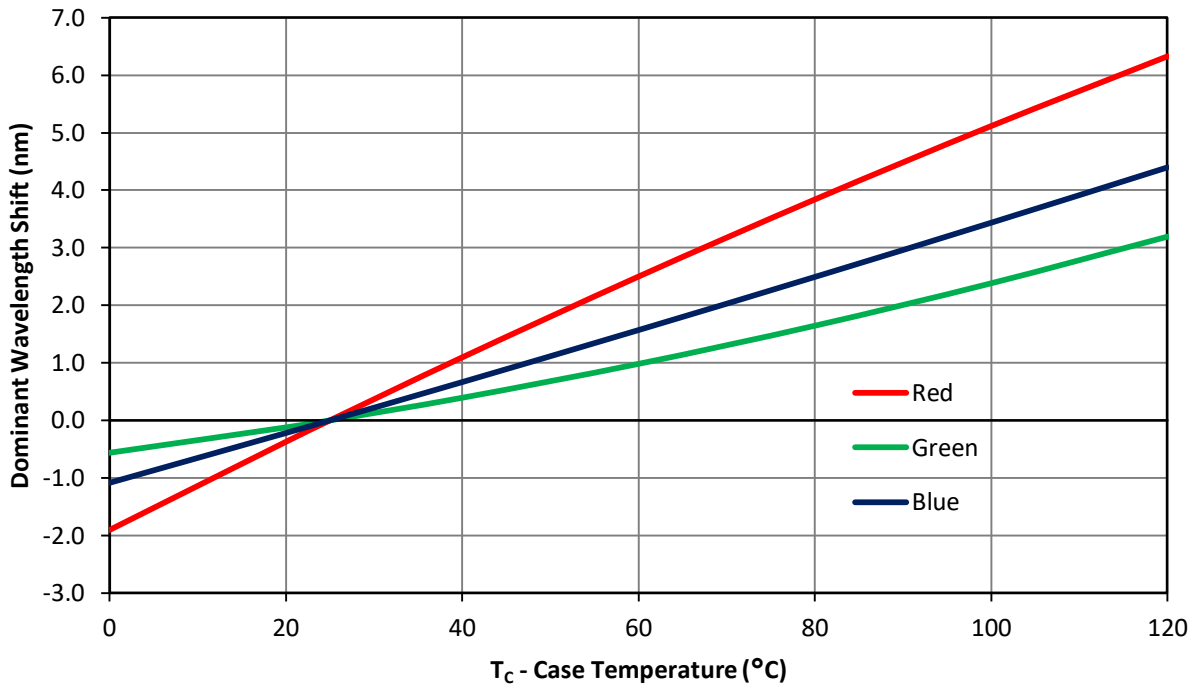

Figure 10a: Typical dominant wavelength shift vs. case temperature

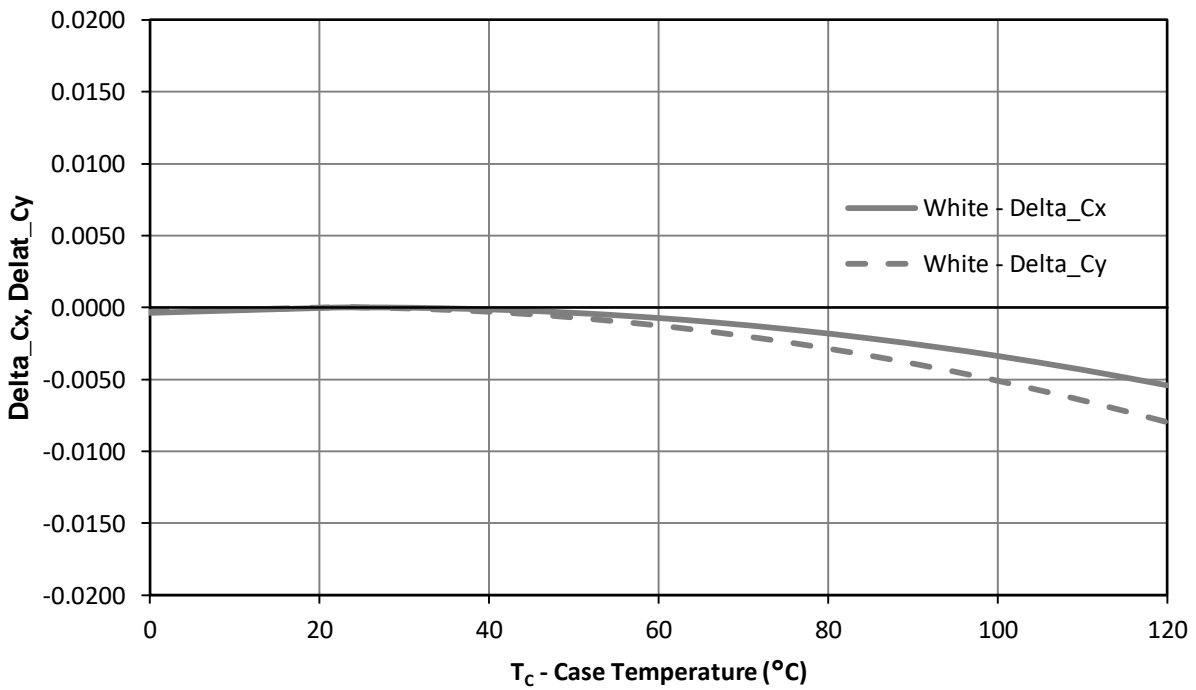

Figure 10b: Typical chromaticity coordinate shift vs. case temperature

Current De-rating

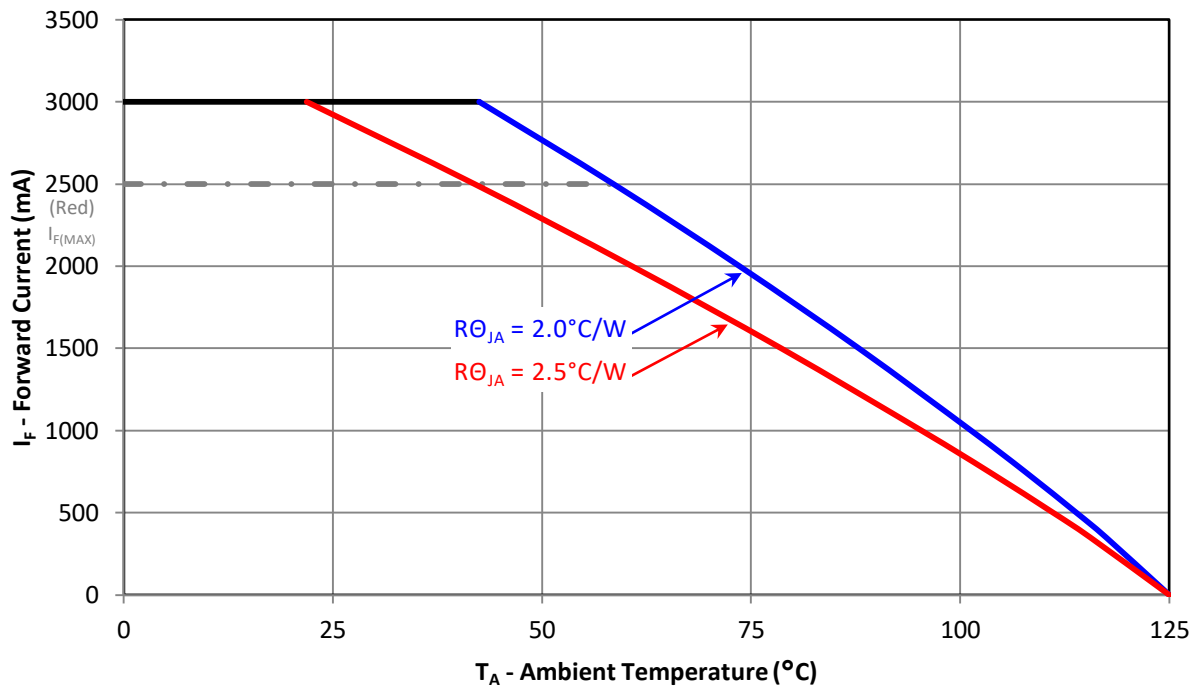

Figure 11: Maximum forward current vs. ambient temperature

Notes for Figure 11:

1. Maximum current assumes that all four LED dice are operating concurrently at the same current.
2. $R\theta_{J-C}$ [Junction to Case Thermal Resistance] for LZ4-04MDPB is 0.9°C/W at 1.0A, 1.5°C/W at 3.0A.
3. $R\theta_{J-A}$ [Junction to Ambient Thermal Resistance] = $R\theta_{J-C}$ + $R\theta_{C-A}$ [Case to Ambient Thermal Resistance].

Emitter Tape and Reel Specifications (mm)

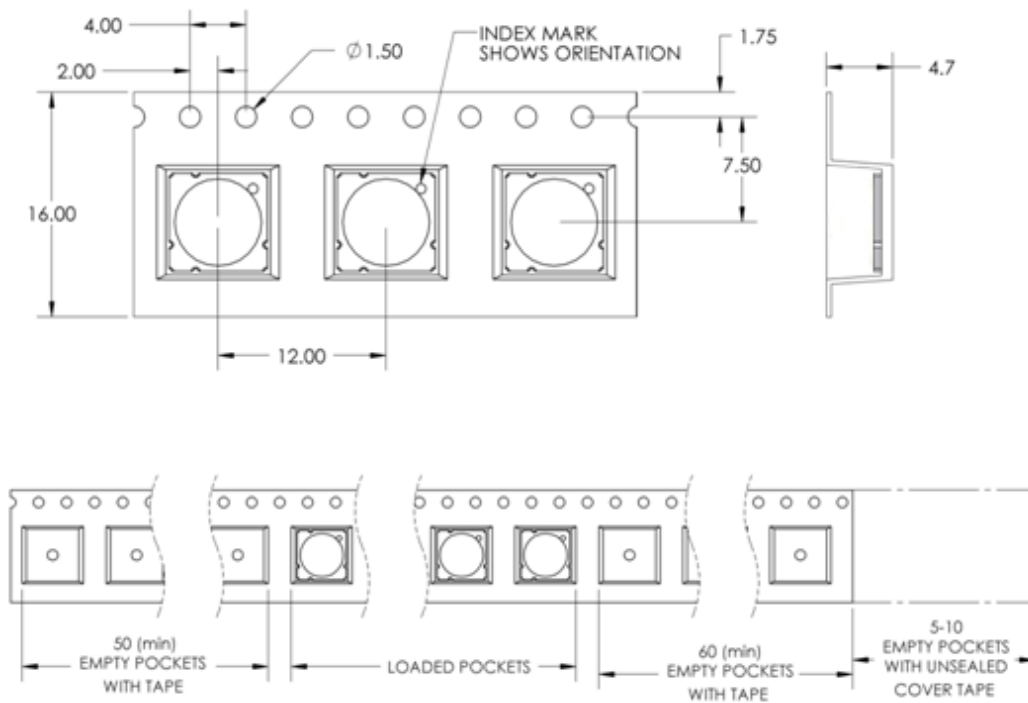

Figure 12: Emitter carrier tape specifications (mm).

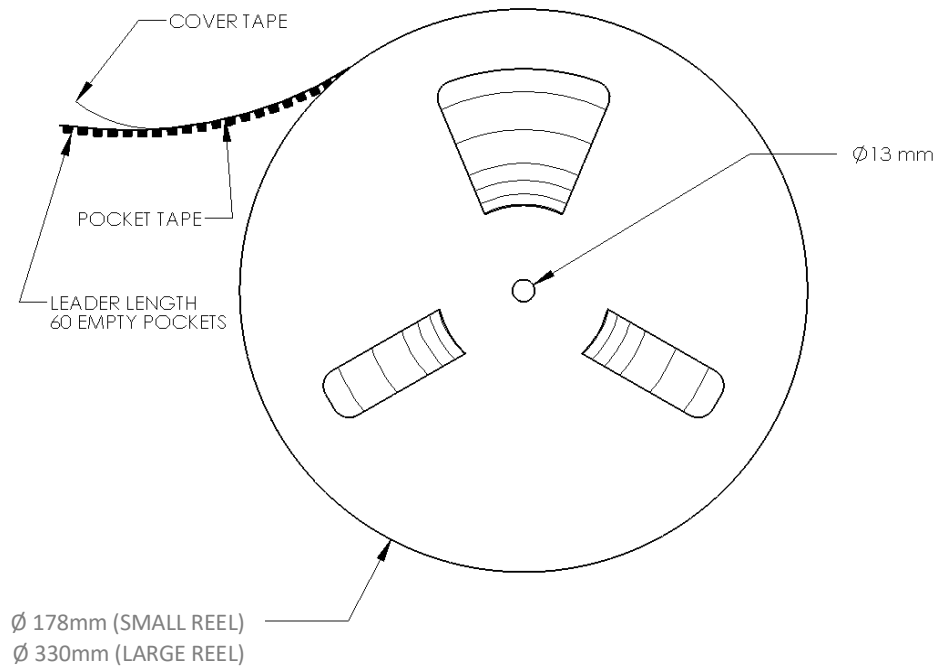

Figure 13: Emitter reel specifications (mm).

Notes for Figure 13:

1. Small reel quantity: up to 250 emitters
2. Large reel quantity: 250-2000 emitters.
3. Single flux bin and single wavelength per reel.

LZ4 MCPCB Family

Part number	Type of MCPCB	Diameter (mm)	Emitter + MCPCB Thermal Resistance (°C/W)	Typical V _F (V)	Typical I _F (mA)
LZ4-Vxxxxx	4-channel	19.9	0.9 + 0.1 = 1.0	2.4 – 3.5	1000
			1.5 + 0.1 = 1.6	2.8 – 4.0	2500 (R) 3000 (G,B,W)

LZ4-Vxxxxx

4 channel, Standard Star MCPCB (4x1) Dimensions (mm)

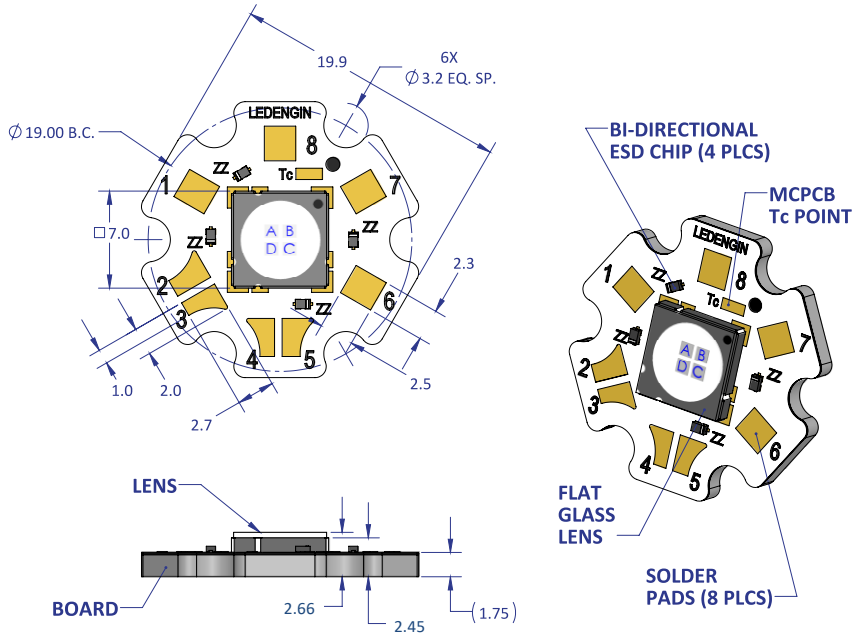

Notes:

- Unless otherwise noted, the tolerance = ± 0.2 mm.
- Slots in MCPCB are for M3 or #4-40 mounting screws.
- The thermal resistance of the MCPCB is: $R_{\theta C-B} 0.1^{\circ}\text{C/W}$

Components used

MCPCB:	MHE-301 copper	(Rayben)
ESD/ TVS Diodes:	BZT52C5V1LP-7	(Diodes, Inc., for 1 LED die)
	VBUS05L1-DD1	(Vishay Semiconductors, for 1 LED die)

Pad layout			
Ch.	MCPCB Pad	String/die	Function
1	1	1/A	Anode +
	8		Cathode -
2	7	2/B	Anode +
	6		Cathode -
3	4	3/C	Anode +
	5		Cathode -
4	2	4/D	Anode +
	3		Cathode -

Application Guidelines

MCPCB Assembly Recommendations

A good thermal design requires an efficient heat transfer from the MCPCB to the heat sink. In order to minimize air gaps in between the MCPCB and the heat sink, it is common practice to use thermal interface materials such as thermal pastes, thermal pads, phase change materials and thermal epoxies. Each material has its pros and cons depending on the design. Thermal interface materials are most efficient when the mating surfaces of the MCPCB and the heat sink are flat and smooth. Rough and uneven surfaces may cause gaps with higher thermal resistances, increasing the overall thermal resistance of this interface. It is critical that the thermal resistance of the interface is low, allowing for an efficient heat transfer to the heat sink and keeping MCPCB temperatures low.

When optimizing the thermal performance, attention must also be paid to the amount of stress that is applied on the MCPCB. Too much stress can cause the ceramic emitter to crack. To relax some of the stress, it is advisable to use plastic washers between the screw head and the MCPCB and to follow the torque range listed below. For applications where the heat sink temperature can be above 50°C, it is recommended to use high temperature and rigid plastic washers, such as polycarbonate or glass-filled nylon.

LED Engin recommends the use of the following thermal interface materials:

1. Bergquist's Gap Pad 5000S35, 0.020in thick
 - Part Number: Gap Pad® 5000S35 0.020in/0.508mm
 - Thickness: 0.020in/0.508mm
 - Thermal conductivity: 5 W/m-K
 - Continuous use max temperature: 200°C
 - Using M3 Screw (or #4 screw), with polycarbonate or glass-filled nylon washer (#4) the recommended torque range is: 20 to 25 oz-in (1.25 to 1.56 lbf-in or 0.14 to 0.18 N-m)

2. 3M's Acrylic Interface Pad 5590H
 - Part number: 5590H @ 0.5mm
 - Thickness: 0.020in/0.508mm
 - Thermal conductivity: 3 W/m-K
 - Continuous use max temperature: 100°C
 - Using M3 Screw (or #4 screw), with polycarbonate or glass-filled nylon washer (#4) the recommended torque range is: 20 to 25 oz-in (1.25 to 1.56 lbf-in or 0.14 to 0.18 N-m)

Mechanical Mounting Considerations

The mounting of MCPCB assembly is a critical process step. Excessive mechanical stress build up in the MCPCB can cause the MCPCB to warp which can lead to emitter substrate cracking and subsequent cracking of the LED dies

LED Engin recommends the following steps to avoid mechanical stress build up in the MCPCB:

- Inspect MCPCB and heat sink for flatness and smoothness.
- Select appropriate torque for mounting screws. Screw torque depends on the MCPCB mounting method (thermal interface materials, screws, and washer).
- Always use three M3 or #4-40 screws with #4 washers.
- When fastening the three screws, it is recommended to tighten the screws in multiple small steps. This method avoids building stress by tilting the MCPCB when one screw is tightened in a single step.
- Always use plastic washers in combinations with the three screws. This avoids high point contact stress on the screw head to MCPCB interface, in case the screw is not seated perpendicular.
- In designs with non-tapped holes using self-tapping screws, it is common practice to follow a method of three turns tapping a hole clockwise, followed by half a turn anti-clockwise, until the appropriate torque is reached.

Wire Soldering

- To ease soldering wire to MCPCB process, it is advised to preheat the MCPCB on a hot plate of 125-150°C. Subsequently, apply the solder and additional heat from the solder iron will initiate a good solder reflow. It is recommended to use a solder iron of more than 60W.
- It is advised to use lead-free, no-clean solder. For example: SN-96.5 AG-3.0 CU 0.5 #58/275 from Kester (pn: 24-7068-7601)

About LED Engin

LED Engin, an OSRAM business based in California's Silicon Valley, develops, manufactures, and sells advanced LED emitters, optics and light engines to create uncompromised lighting experiences for a wide range of entertainment, architectural, general lighting and specialty applications. LuxiGen™ multi-die emitter and secondary lens combinations reliably deliver industry-leading flux density, upwards of 5000 quality lumens to a target, in a wide spectrum of colors including whites, tunable whites, multi-color and UV LEDs in a unique patented compact ceramic package. Our LuxiTune™ series of tunable white lighting modules leverage our LuxiGen emitters and lenses to deliver quality, control, freedom and high density tunable white light solutions for a broad range of new recessed and downlighting applications. The small size, yet remarkably powerful beam output and superior in-source color mixing, allows for a previously unobtainable freedom of design wherever high-flux density, directional light is required. LED Engin is committed to providing products that conserve natural resources and reduce greenhouse emissions; and reserves the right to make changes to improve performance without notice.

For more information, please contact LEDE-Sales@osram.com or +1 408 922-7200.

X-ON Electronics

Largest Supplier of Electrical and Electronic Components

Click to view similar products for [High Power LEDs - Multi-Colour category](#):

Click to view products by [LED Engin manufacturer](#):

Other Similar products are found below :

[11-22/R8G6C-A30/2T](#) [LL-HP60NUYC](#) [OSB5XZE1E1E](#) [OSG5XDE5E1E](#) [OSR5XAE1E1E](#) [OSR5XAE3E1E](#) [OSR5XME1E1E](#)
[OSY5XDE5E1E](#) [PC8N-5LTS-C](#) [PK2N-3LAE-SD](#) [PK2N-3LGE-SD](#) [PK2N-3LRE-SD](#) [PM2B-3LGS-SD](#) [PQ2A-4FGE](#) [PQ2A-4FPE-YGFC](#)
[PM2E-1LAS](#) [PM2E-1LGS](#) [PM2E-1LRS](#) [PM2E-3LAE-SD](#) [PM2E-3LAS-SD](#) [PM2E-3LBS-SD](#) [PM2E-3LGS-SD](#) [PM2E-3LRE-SD](#) [PM2E-](#)
[3LRS-SD](#) [PP6N-TFFE-D60](#) [PP6N-3LFE](#) [PP6N-1LFE-P](#) [PK2N-3LLE-L](#) [OSB4XDE5E1E](#) [OSG5XME1E1E](#) [OSR5XAT1C1E](#)
[OSR5XAT3C1E](#) [OSR5XDE5E1E](#) [OSY5XAE3E1E](#) [OSY5XAT3C1E](#) [OSY5XME3E1E](#) [PC8N-5L4E-C](#) [PK2N-3LBE-SD](#) [PM2B-1LPE-M](#)
[PM2B-1LPS-M](#) [PQ2A-4FBE](#) [PQ2A-4FRE](#) [AAAF5051-05](#) [L1MC-RGB3080500MP0](#) [SBM-40-RGBW-SC41-QD100](#) [OSG5XME3E1E](#)
[OSG5XZE3E1E](#) [OSY5XME1E1E](#) [PBED-15F4E-A](#) [PBLB-3LFE](#)