

EVA-W

~40° wide beam

TECHNICAL SPECIFICATIONS:

| | |
|----------------|-----------|
| Dimensions | Ø 35.0 mm |
| Height | 16.4 mm |
| Fastening | glue |
| ROHS compliant | yes ⓘ |

MATERIAL SPECIFICATIONS:

| Component | Type | Material | Colour | Finish |
|-----------|-------------|----------|--------|--------|
| EVA-W | Single lens | PMMA | clear | |

ORDERING INFORMATION:

| Component | Qty in box | MOQ | MPQ | Box weight (kg) |
|------------------------------------------------|------------|-----|-----|-----------------|
| C10686_EVA-W » Box size: 480 x 280 x 300 mm | 540 | 90 | 45 | 5.5 |



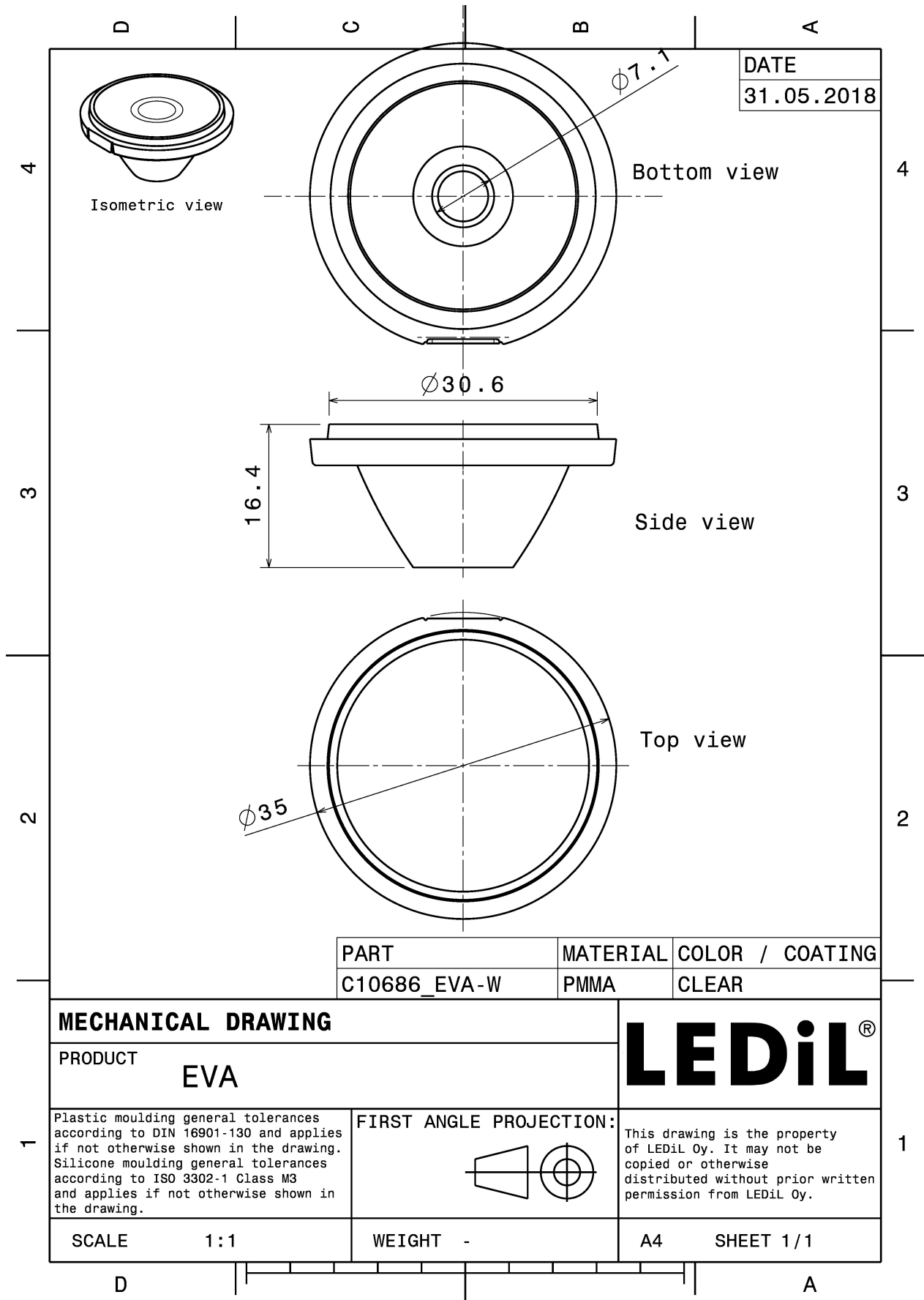

See also our general installation guide: www.ledil.com/installation_guide

PHOTOMETRIC DATA (MEASURED):

CITIZEN

LED CLU7A2 (LES 4.2mm)
 FWHM / FWTM 35.0° / 65.0°
 Efficiency 86 %
 Peak intensity 1.9 cd/lm
 LEDs/each optic 1
 Light colour White
 Required components:

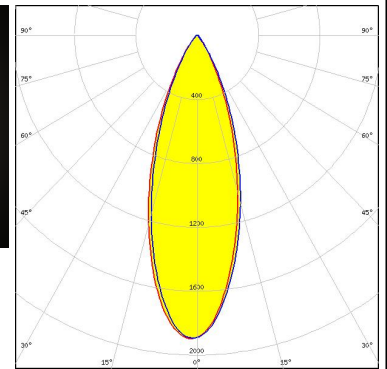
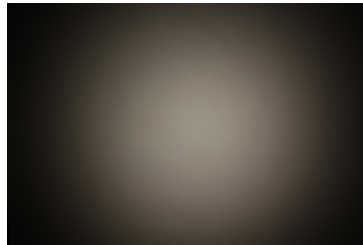

CREE → LED

LED MC-E
 FWHM / FWTM 36.0°
 Efficiency 91 %
 Peak intensity 1 cd/lm
 LEDs/each optic 1
 Light colour White
 Required components:

CREE → LED

LED MHB-A/B
 FWHM / FWTM 39.0° / 70.0°
 Efficiency 78 %
 Peak intensity 1.7 cd/lm
 LEDs/each optic 1
 Light colour White
 Required components:

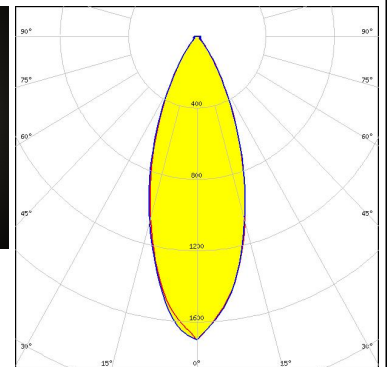
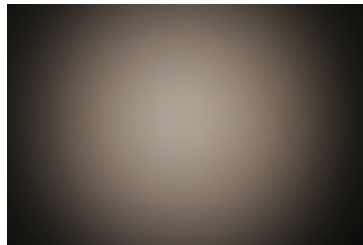

CREE → LED

LED MK-R
 FWHM / FWTM 48.0° / 75.0°
 Efficiency %
 Peak intensity 1.2 cd/lm
 LEDs/each optic 1
 Light colour White
 Required components:

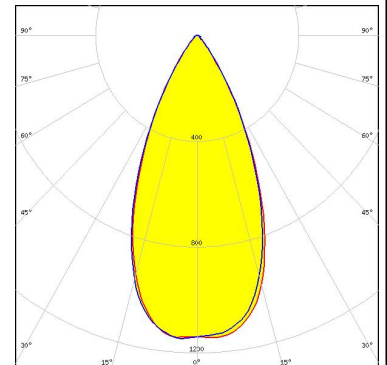

PHOTOMETRIC DATA (MEASURED):

CREE → LED

LED XHP35 HI
 FWHM / FWTM 57.0° / 82.0°
 Efficiency 75 %
 Peak intensity 0.8 cd/lm
 LEDs/each optic 1
 Light colour White
 Required components:

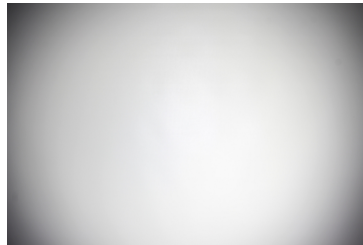

CREE → LED

LED XM-L
 FWHM / FWTM 40.0°
 Efficiency 79 %
 LEDs/each optic 1
 Light colour White
 Required components:

CREE → LED

LED XP-G2
 FWHM / FWTM 32.0° / 64.0°
 Efficiency 81 %
 Peak intensity 2.2 cd/lm
 LEDs/each optic 1
 Light colour White
 Required components:



CREE → LED

LED XT-E
 FWHM / FWTM 32.0°
 Efficiency %
 Peak intensity 1.8 cd/lm
 LEDs/each optic 1
 Light colour White
 Required components:

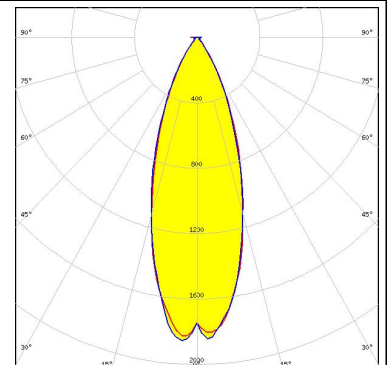

PHOTOMETRIC DATA (MEASURED):

LUMILEDS

LED LUXEON 5050 Round LES
 FWHM / FWTM 37.0° / 67.0°
 Efficiency 83 %
 Peak intensity 1.7 cd/lm
 LEDs/each optic 1
 Light colour White
 Required components:

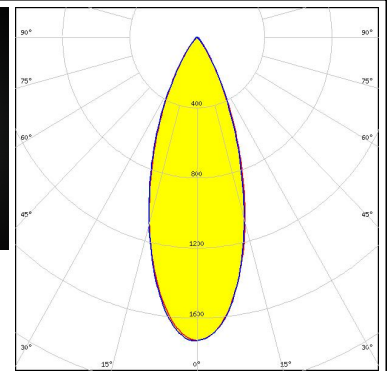
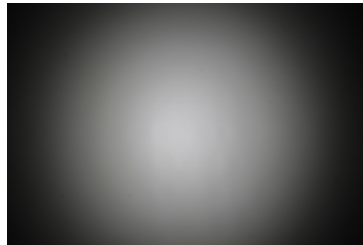

LUMILEDS

LED LUXEON M/MX
 FWHM / FWTM 45.0°
 Efficiency 80 %
 Peak intensity 1.3 cd/lm
 LEDs/each optic 1
 Light colour White
 Required components:

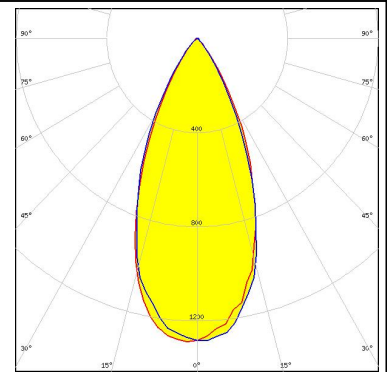
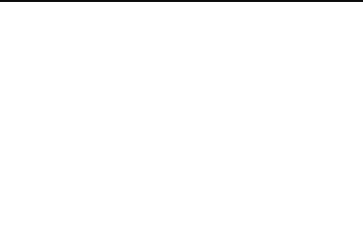

LUMILEDS

LED LUXEON MZ
 FWHM / FWTM 36.0° / 66.0°
 Efficiency 81 %
 Peak intensity 1.9 cd/lm
 LEDs/each optic 1
 Light colour White
 Required components:

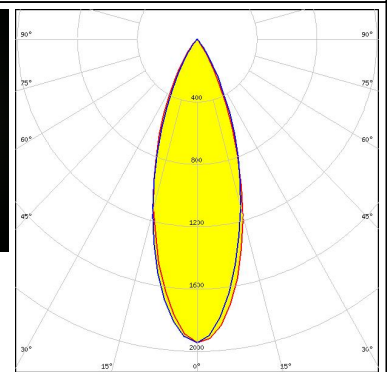
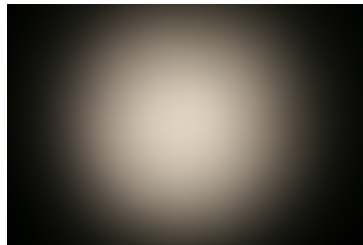

NICHIA

LED NS9x383
 FWHM / FWTM 39.0° / 68.0°
 Efficiency 81 %
 Peak intensity 1.6 cd/lm
 LEDs/each optic 1
 Light colour White
 Required components:

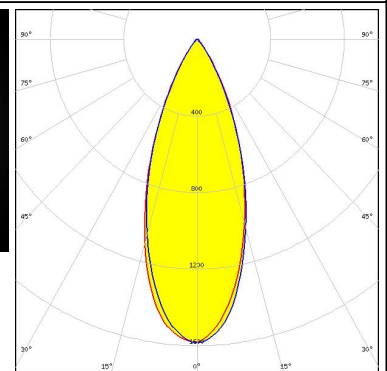
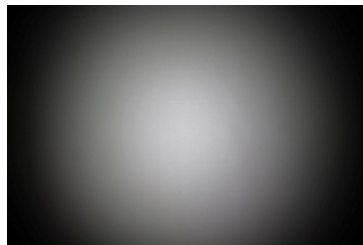

PHOTOMETRIC DATA (MEASURED):

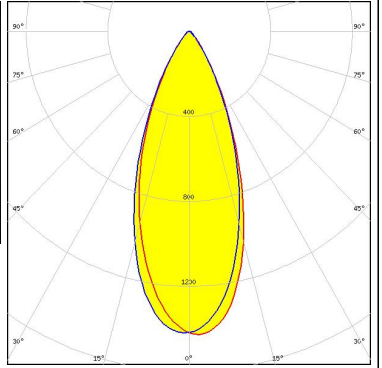
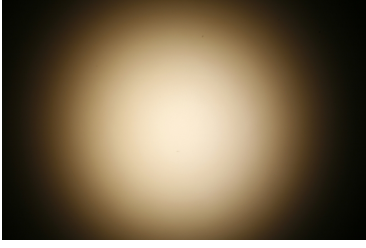
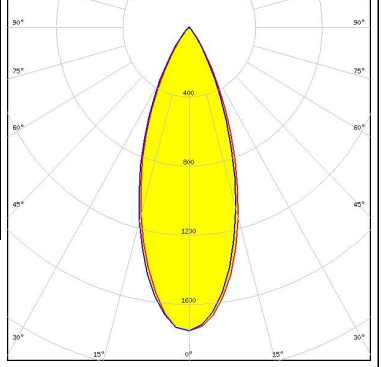
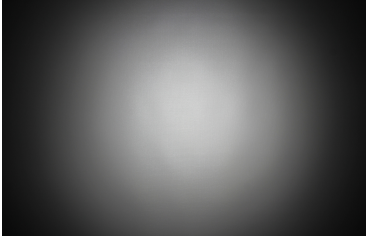
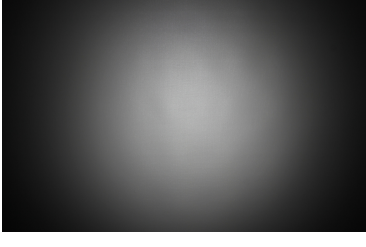
| | | |
|----------------------------------------------------------------------------------------------------------------------------------------------------------------------------------------------------------------------------------------------------------------------------------------|--------------------------------------------------------------------------------------|--------------------------------------------------------------------------------------|
| <p>NICHIA</p> <p>LED NSMx286M FWHM / FWTM 41.0° / 72.0° Efficiency 80 % Peak intensity 1.4 cd/lm LEDs/each optic 1 Light colour White Required components:</p> |  |  |
| <p>OSRAM Opto Semiconductors</p> <p>LED Duris S8 FWHM / FWTM 39.0° / 68.0° Efficiency 81 % Peak intensity 1.8 cd/lm LEDs/each optic 1 Light colour White Required components:</p> |  |  |
| <p>SEOUL SEMICONDUCTOR</p> <p>LED Z8Y15 FWHM / FWTM 29.0° / 62.0° Efficiency 80 % Peak intensity 2.3 cd/lm LEDs/each optic 1 Light colour White Required components:</p> |  | |
| <p>SEOUL SEMICONDUCTOR</p> <p>LED Z8Y19 FWHM / FWTM 30.0° / 62.0° Efficiency 81 % Peak intensity 2.3 cd/lm LEDs/each optic 1 Light colour White Required components:</p> |  | |

PHOTOMETRIC DATA (SIMULATED):

CITIZEN

LED CLU700/701/702
 FWHM / FWTM 41.0° / 72.0°
 Efficiency 88 %
 Peak intensity 1.6 cd/lm
 LEDs/each optic 1
 Light colour White
 Required components:

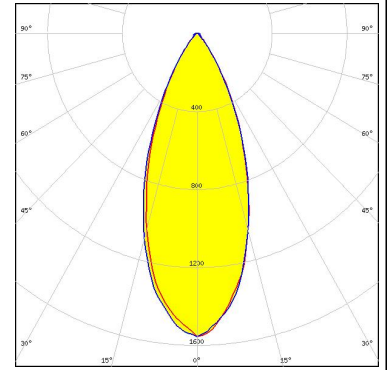

CREE LED

LED XM-L HVW
 FWHM / FWTM 38.0°
 Efficiency %
 LEDs/each optic 1
 Light colour White
 Required components:

LUMILEDS

LED LUXEON 5258
 FWHM / FWTM 34.0° / 66.0°
 Efficiency 87 %
 Peak intensity 1.9 cd/lm
 LEDs/each optic 1
 Light colour White
 Required components:

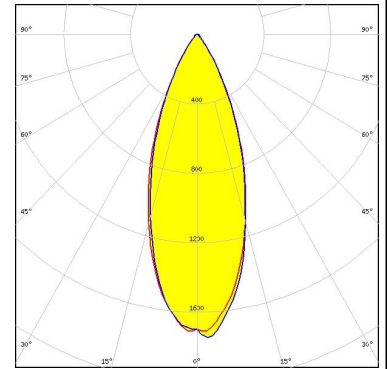

LUMINUS

LED CXM-3
 FWHM / FWTM 35.0° / 66.0°
 Efficiency 89 %
 Peak intensity 2 cd/lm
 LEDs/each optic 1
 Light colour White
 Required components:

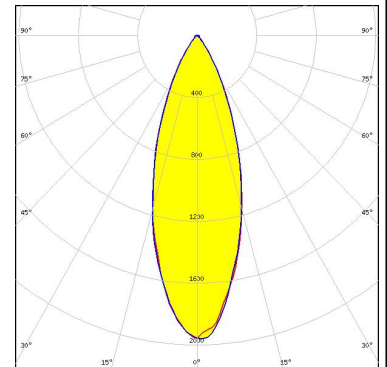

PHOTOMETRIC DATA (SIMULATED):



LED CXM-4
FWHM / FWTM 36.0° / 68.0°
Efficiency 88 %
Peak intensity 1.9 cd/lm
LEDs/each optic 1
Light colour White
Required components:

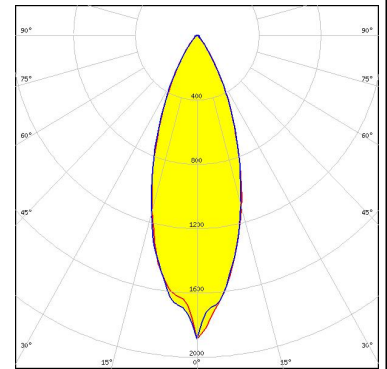

LED NFMW48xA
FWHM / FWTM 43.0° / 72.0°
Efficiency 90 %
Peak intensity 1.5 cd/lm
LEDs/each optic 1
Light colour White
Required components:

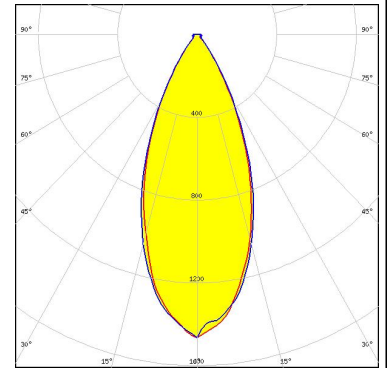

OSRAM
Opto Semiconductors
LED OSCONIQ P 7070
FWHM / FWTM 41.0° / 71.0°
Efficiency 87 %
Peak intensity 1.6 cd/lm
LEDs/each optic 1
Light colour White
Required components:

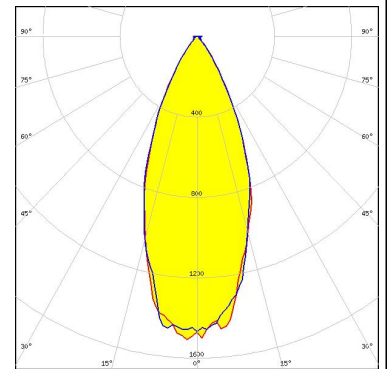

GENERAL INFORMATION:

NOTE: The typical beam angle will be changed by different color, chip size and chip position tolerance. The typical total beam angle is the full angle measured where the luminous intensity is half of the peak value.

Due to use of high power COB's with this product, special attention to proper thermal design is highly recommended. LEDiL has no liability for direct, indirect or consecutive damages arising from the LEDiL products being used outside of the recommended temperature range.

MATERIALS:

As part of our continuous research and improvement processes, and to ensure the best possible quality and availability of our products, LEDiL reserves the right to change material grades without notice.

PRODUCT DATA USER AGREEMENT AND DISCLAIMER:

The measured data in the provided downloadable LEDiL Product Datasheets and Mechanical 2D-Drawings is rounded and provided as reference for planning. LEDiL Oy's optical specifications have been verified by conducting performance testing of the products in accordance with the company's quality system. The reported data are averaged results of multiple measurements with typical variation. LEDiL Oy reserves the right to without prior notification make changes and improvements to its products.

LEDiL Oy assumes neither warranty, nor guarantee nor any other liability of any kind for the contents and correctness of the provided data. The provided data has been generated with highest diligence but the provided data may in reality not represent the complete possible variation range of all intrinsic parameters. Therefore, in certain cases a deviation from the provided data could occur.

LEDiL Oy reserves the right to undertake technical changes of its products without further notification which could lead to changes in the provided data. LEDiL Oy assumes no liability of any kind for the possible deviation from any provided data or any other damage resulting from the usage of the provided data.

The user agrees to this disclaimer and user agreement with the download or usage of the provided files.

LEDiL Oy

Joensuunkatu 13
FI-24240 SALO
Finland

LEDiL Inc.

228 West Page Street
Suite D
Sycamore IL 60178
USA

Ledil Optics Technology (Shenzhen) Co., Ltd.

405 , Block B
Casic Motor Building
Shenzhen 518057
P.R.CHINA

Local sales and technical support

[www.ledil.com/
where_to_buy](http://www.ledil.com/where_to_buy)

Shipping locations

Salo, Finland
Hong Kong, China

Distribution Partners

[www.ledil.com/
where_to_buy](http://www.ledil.com/where_to_buy)

X-ON Electronics

Largest Supplier of Electrical and Electronic Components

Click to view similar products for [LED Lighting Lenses](#) category:

Click to view products by [Ledil](#) manufacturer:

Other Similar products are found below :

[LL01ED-AK40L06](#) [LL01ZZ-EX25L06-M2](#) [180182-0000](#) [LL01ED-ALI55R49](#) [C14707_IDA16-O](#) [C12231_LENA-FRESNEL-LENS](#)
[LL01ED-AKY24R49](#) [LL01CR-AYG15R49](#) [LL01CR-OT32L06-M2](#) [LL01ZZ-AAA24L49](#) [LL01CR-CEN38L02](#) [LL01ZZ-AAA55L49](#)
[LL01CR-AYG24R49](#) [LL01A00CZMB2-M2](#) [LL01ED-AKY38R49](#) [LL01CR-CNE2545L06-M2](#) [LL01ZZ-AAA38L49](#) [LL01ED-AKV36R49](#)
[LL01ED-ALI24R49](#) [LL01CR-AYG38R49](#) [C17171_DAISSY-8X1-SHD-MATT](#) [F16859_LINDA-ZT25](#) [C17295_ILONA-ZOOM](#)
[F16636_LINDA-W60](#) [C17362_DAISSY-7X1-W-D](#) [C17361_DAISSY-7X1-WW-D](#) [10003](#) [10003/15](#) [10048](#) [10049](#) [10108](#) [10510](#)
[F14487_FLORENCE-1R-MAXI-WG](#) [12667](#) [C14165_STRADA-2X2-ME-WIDE2](#) [C14605_HB-2X2-RW](#) [C14642_FLORENCE-1R-UP](#)
[CAY033](#) [CAY046/55](#) [FCX11157_RES-O-90](#) [OS-LRI2015X45S](#) [OSOLRA2015M](#) [PG1C-NX36](#) [PG1C-SX17](#) [PM2A-SXV1](#) [PM2B-NX55-](#)
[AW](#) [PM6A-FN25](#) [FC2231-0000-0050-L](#) [FC2231-0000-0100-L](#) [C14116_STRADA-2X2-PX](#)