

## CUTE-3-W

~40° wide beam with 1.5 mm high location pins

### TECHNICAL SPECIFICATIONS:

Dimensions	Ø 35.0 mm
Height	15 mm
Fastening	glue, pin
ROHS compliant	yes ⓘ

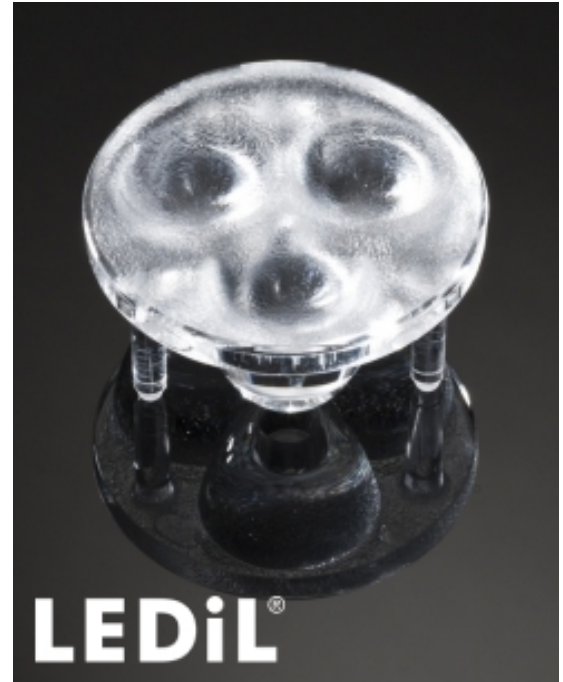

### MATERIAL SPECIFICATIONS:

Component	Type	Material	Colour	Finish
CUTE-3-W	Multi-lens	PMMA	clear	



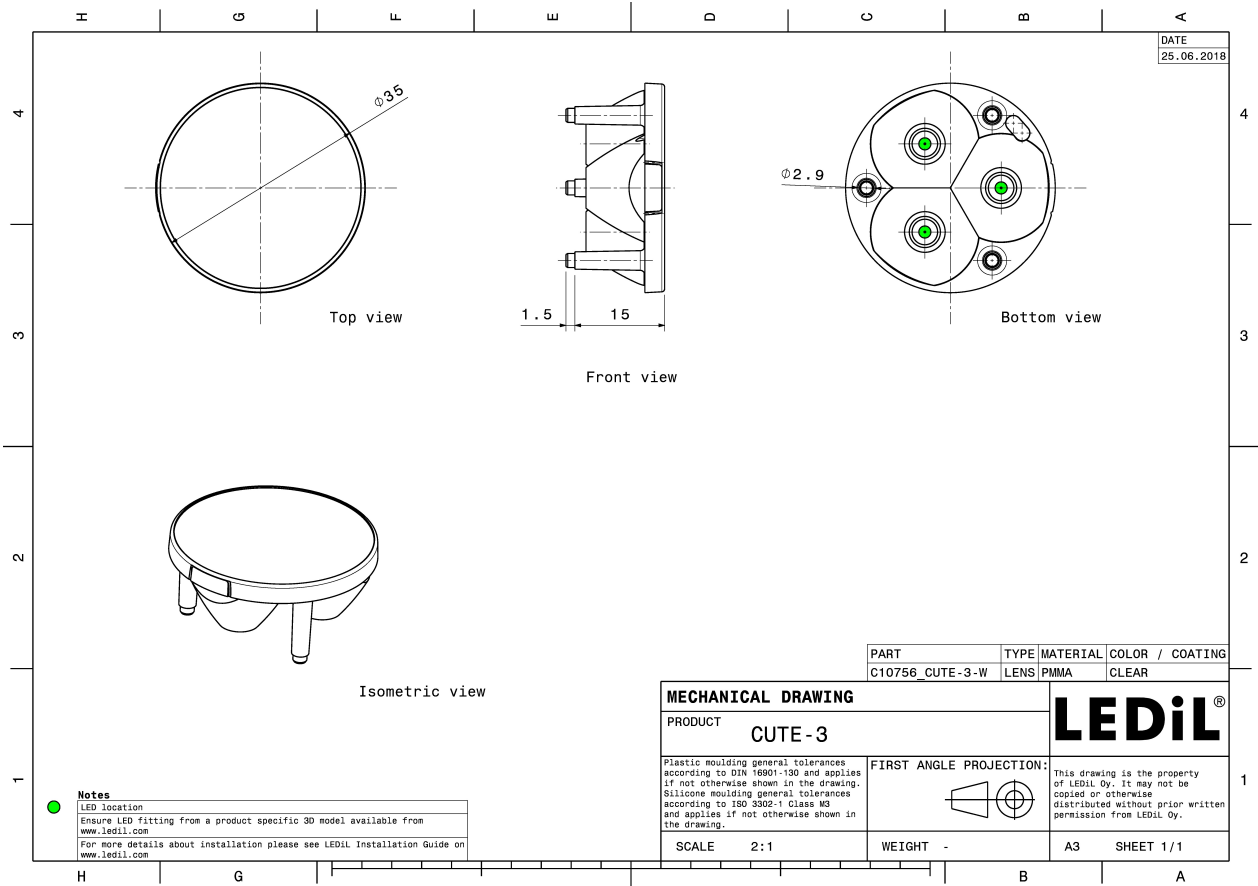

### ORDERING INFORMATION:

Component	Qty in box	MOQ	MPQ	Box weight (kg)
C10756_CUTE-3-W » Box size: 480 x 280 x 300 mm	630	90	45	7.0

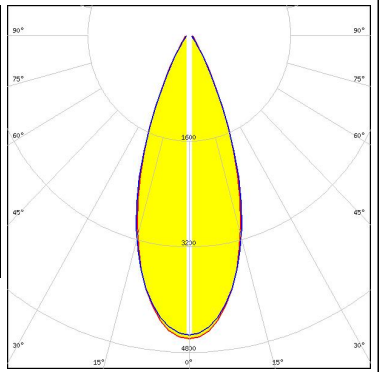

See also our general installation guide: [www.ledil.com/installation\\_guide](http://www.ledil.com/installation_guide)

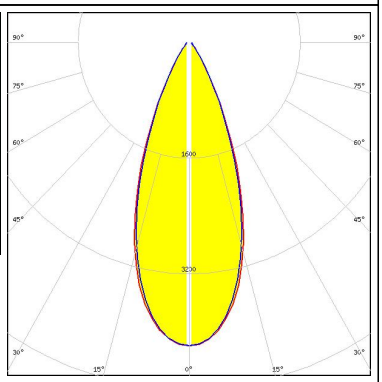
#### PHOTOMETRIC DATA (MEASURED):

<p><b>CREE</b> → <b>LED</b></p> <p>LED            XP-E            FWHM / FWTM    40.0° / 70.0°            Efficiency        90 %            Peak intensity    1.5 cd/m            LEDs/each optic   1            Light colour      White            Required components:</p>		
<p><b>CREE</b> → <b>LED</b></p> <p>LED            XP-G            FWHM / FWTM    40.0° / 68.0°            Efficiency        90 %            Peak intensity    1.4 cd/m            LEDs/each optic   1            Light colour      White            Required components:</p>		
<p><b>CREE</b> → <b>LED</b></p> <p>LED            XP-G2            FWHM / FWTM    40.0° / 68.0°            Efficiency        87 %            Peak intensity    1.8 cd/m            LEDs/each optic   1            Light colour      White            Required components:</p>		
<p><b>CREE</b> → <b>LED</b></p> <p>LED            XP-L HD            FWHM / FWTM    46.0° / 76.0°            Efficiency        84 %            Peak intensity    1.4 cd/m            LEDs/each optic   1            Light colour      White            Required components:</p>		

### PHOTOMETRIC DATA (MEASURED):

#### CREE LED

LED XT-E  
 FWHM / FWTM 39.0° / 68.0°  
 Efficiency %  
 Peak intensity 1.7 cd/lm  
 LEDs/each optic 1  
 Light colour White  
 Required components:

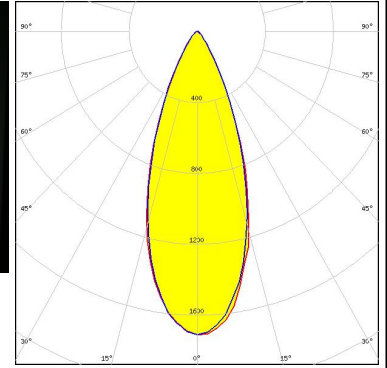
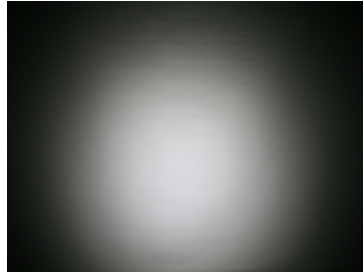

#### LUMILEDS

LED LUXEON A  
 FWHM / FWTM 41.0°  
 Efficiency 77 %  
 LEDs/each optic 1  
 Light colour White  
 Required components:

#### LUMILEDS

LED LUXEON Rebel  
 FWHM / FWTM 38.0°  
 Efficiency 77 %  
 LEDs/each optic 1  
 Light colour White  
 Required components:

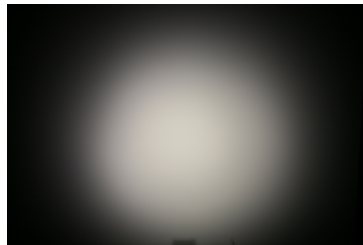

#### LUMILEDS

LED LUXEON Rebel ES  
 FWHM / FWTM 41.0°  
 Efficiency 77 %  
 LEDs/each optic 1  
 Light colour White  
 Required components:

### PHOTOMETRIC DATA (MEASURED):

#### LUMILEDS

LED LUXEON T  
 FWHM / FWTM 42.0° / 70.0°  
 Efficiency 86 %  
 Peak intensity 1.6 cd/lm  
 LEDs/each optic 1  
 Light colour White  
 Required components:

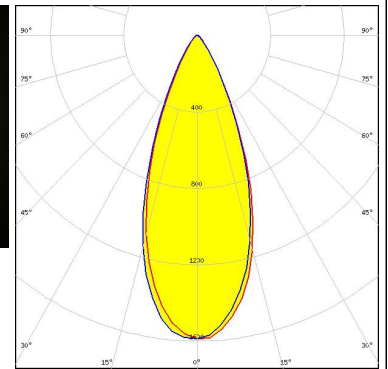
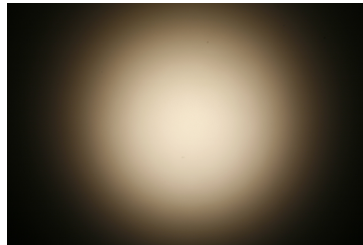

#### LUMILEDS

LED LUXEON TX  
 FWHM / FWTM 40.0° / 67.0°  
 Efficiency 85 %  
 Peak intensity 1.7 cd/lm  
 LEDs/each optic 1  
 Light colour White  
 Required components:

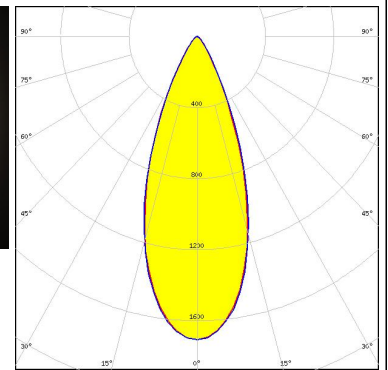
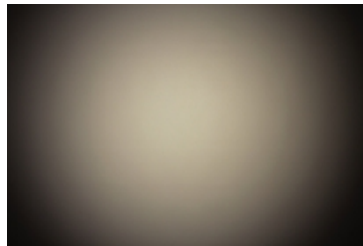

#### NICHIA

LED NCSxx19A  
 FWHM / FWTM 39.0°  
 Efficiency 84 %  
 LEDs/each optic 1  
 Light colour White  
 Required components:



#### NICHIA

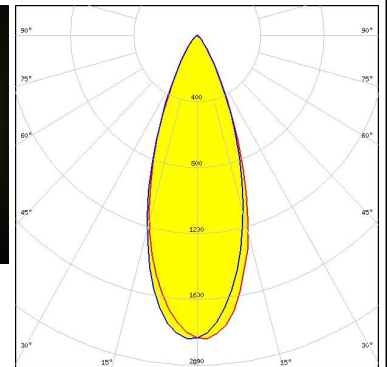

LED NCSxx19B  
 FWHM / FWTM 38.0° / 67.0°  
 Efficiency 85 %  
 Peak intensity 1.8 cd/lm  
 LEDs/each optic 1  
 Light colour White  
 Required components:

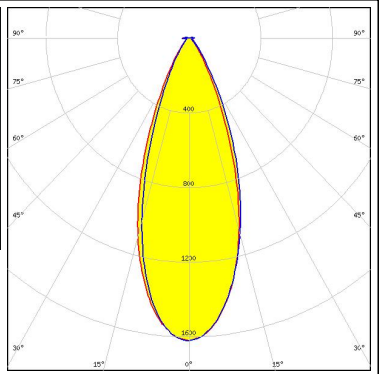
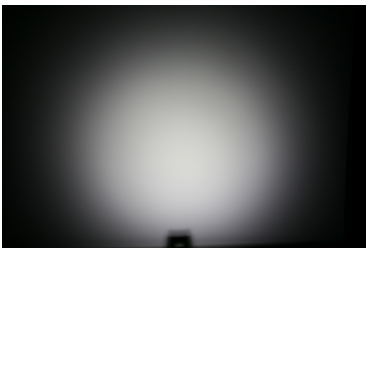
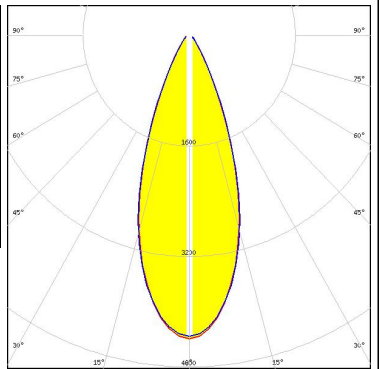

### PHOTOMETRIC DATA (MEASURED):

<p><b>NICHIA</b></p> <p>LED                    NVSxx19A            FWHM / FWTM    38.0° / 68.0°            Efficiency        90 %            Peak intensity    1.6 cd/lm            LEDs/each optic 1            Light colour      White            Required components:</p>		
<p><b>OSRAM</b> Opto Semiconductors</p> <p>LED                    OSLOM Square EC            FWHM / FWTM    36.0° / 66.0°            Efficiency        78 %            Peak intensity    1.9 cd/lm            LEDs/each optic 1            Light colour      White            Required components:</p>		
<p><b>OSRAM</b> Opto Semiconductors</p> <p>LED                    OSLOM SSL 150            FWHM / FWTM    40.0°            Efficiency        83 %            LEDs/each optic 1            Light colour      White            Required components:</p>		
<p><b>OSRAM</b> Opto Semiconductors</p> <p>LED                    OSLOM SSL 80            FWHM / FWTM    40.0°            Efficiency        83 %            LEDs/each optic 1            Light colour      White            Required components:</p>		

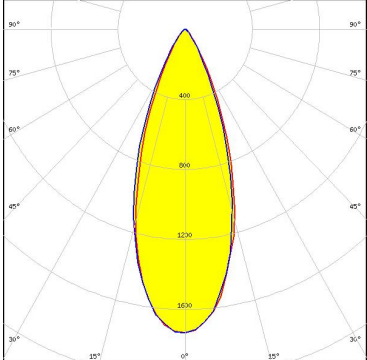
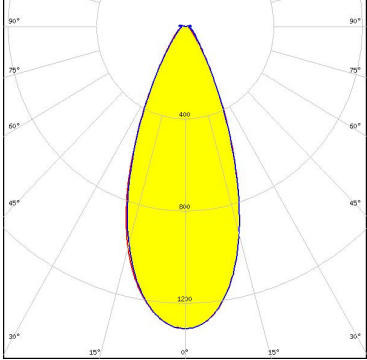
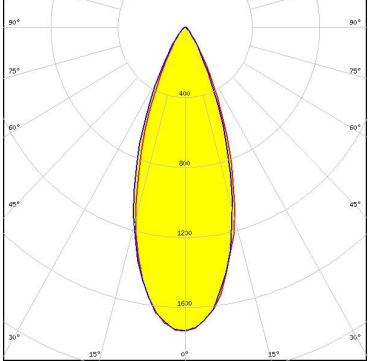
### PHOTOMETRIC DATA (MEASURED):

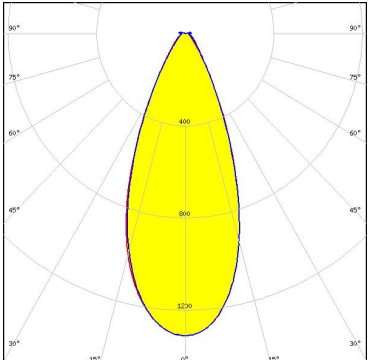
 SEOUL SEMICONDUCTOR		
LED	Z5	
FWHM / FWTM	40.0°	
Efficiency	%	
LEDs/each optic	1	
Light colour	White	
Required components:		
 SEOUL SEMICONDUCTOR		
LED	Z5M1/Z5M2	
FWHM / FWTM	38.0° / 67.0°	
Efficiency	84 %	
Peak intensity	1.7 cd/lm	
LEDs/each optic	1	
Light colour	White	
Required components:		
 Leading Innovation >>>		
LED	TL1L3	
FWHM / FWTM	42.0° / 75.0°	
Efficiency	90 %	
Peak intensity	1.3 cd/lm	
LEDs/each optic	1	
Light colour	White	
Required components:		

### PHOTOMETRIC DATA (SIMULATED):

#### CREE → LED

LED XHP35 HD  
 FWHM / FWTM 45.0° / 65.0°  
 Efficiency 90 %  
 Peak intensity 1.6 cd/lm  
 LEDs/each optic 1  
 Light colour White  
 Required components:

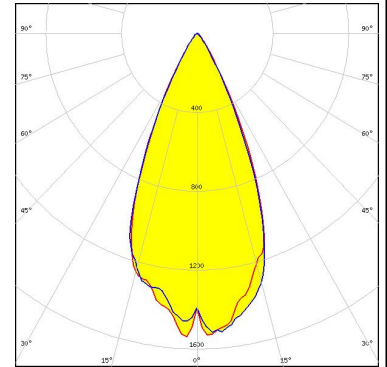

#### CREE → LED

LED XHP35 HI  
 FWHM / FWTM 41.0° / 56.0°  
 Efficiency 93 %  
 Peak intensity 2.3 cd/lm  
 LEDs/each optic 1  
 Light colour White  
 Required components:

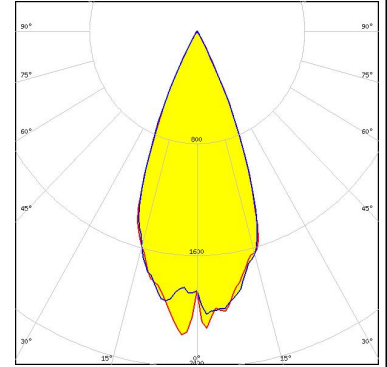

#### CREE → LED

LED XP-G3  
 FWHM / FWTM 44.0° / 67.0°  
 Efficiency 94 %  
 Peak intensity 1.7 cd/lm  
 LEDs/each optic 1  
 Light colour White  
 Required components:

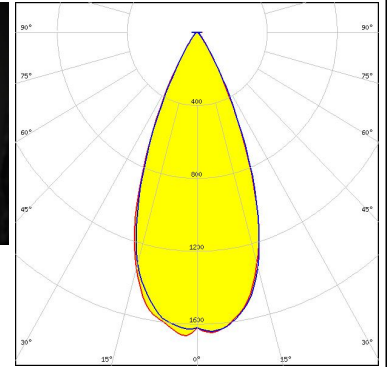
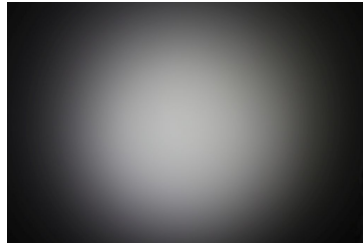

#### CREE → LED

LED XT-E HVW  
 FWHM / FWTM 40.0°  
 Efficiency %  
 LEDs/each optic 1  
 Light colour White  
 Required components:



### PHOTOMETRIC DATA (SIMULATED):

#### LUMILEDS

LED LUXEON H50-2  
 FWHM / FWTM 41.0° / 59.0°  
 Efficiency 90 %  
 Peak intensity 2.1 cd/lm  
 LEDs/each optic 1  
 Light colour White  
 Required components:

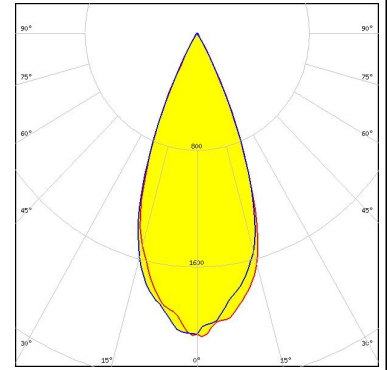

#### NICHIA

LED NVSxx19B/NVSxx19C  
 FWHM / FWTM 41.0° / 61.0°  
 Efficiency 92 %  
 Peak intensity 1.9 cd/lm  
 LEDs/each optic 1  
 Light colour White  
 Required components:

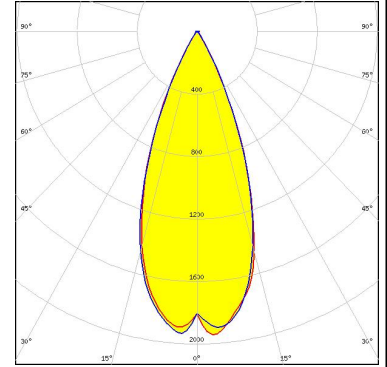

#### SAMSUNG

LED LH351B  
 FWHM / FWTM 44.0° / 66.0°  
 Efficiency 95 %  
 Peak intensity 1.7 cd/lm  
 LEDs/each optic 1  
 Light colour White  
 Required components:

### GENERAL INFORMATION:

NOTE: The typical beam angle will be changed by different color, chip size and chip position tolerance. The typical total beam angle is the full angle measured where the luminous intensity is half of the peak value.

### MATERIALS:

As part of our continuous research and improvement processes, and to ensure the best possible quality and availability of our products, LEDiL reserves the right to change material grades without notice.

### PRODUCT DATA USER AGREEMENT AND DISCLAIMER:

The measured data in the provided downloadable LEDiL Product Datasheets and Mechanical 2D-Drawings is rounded and provided as reference for planning. LEDiL Oy's optical specifications have been verified by conducting performance testing of the products in accordance with the company's quality system. The reported data are averaged results of multiple measurements with typical variation. LEDiL Oy reserves the right to without prior notification make changes and improvements to its products.

LEDiL Oy assumes neither warranty, nor guarantee nor any other liability of any kind for the contents and correctness of the provided data. The provided data has been generated with highest diligence but the provided data may in reality not represent the complete possible variation range of all intrinsic parameters. Therefore, in certain cases a deviation from the provided data could occur.

LEDiL Oy reserves the right to undertake technical changes of its products without further notification which could lead to changes in the provided data. LEDiL Oy assumes no liability of any kind for the possible deviation from any provided data or any other damage resulting from the usage of the provided data.

The user agrees to this disclaimer and user agreement with the download or usage of the provided files.

#### LEDiL Oy

Joensuunkatu 13  
FI-24240 SALO  
Finland

#### LEDiL Inc.

228 West Page Street  
Suite D  
Sycamore IL 60178  
USA

#### Ledil Optics Technology (Shenzhen) Co., Ltd.

# 405 , Block B  
Casic Motor Building  
Shenzhen 518057  
P.R.CHINA

#### Local sales and technical support

[www.ledil.com/  
where\\_to\\_buy](http://www.ledil.com/where_to_buy)

#### Shipping locations

Salo, Finland  
Hong Kong, China

#### Distribution Partners

[www.ledil.com/  
where\\_to\\_buy](http://www.ledil.com/where_to_buy)

## X-ON Electronics

Largest Supplier of Electrical and Electronic Components

*Click to view similar products for [LED Lighting Lenses](#) category:*

*Click to view products by [Ledil](#) manufacturer:*

Other Similar products are found below :

[LL01ED-AK40L06](#) [LL01ZZ-EX25L06-M2](#) [180182-0000](#) [LL01ED-ALI55R49](#) [C14707\\_IDA16-O](#) [C12231\\_LENA-FRESNEL-LENS](#)  
[LL01ED-AKY24R49](#) [LL01CR-AYG15R49](#) [LL01CR-OT32L06-M2](#) [LL01ZZ-AAA24L49](#) [LL01CR-CEN38L02](#) [LL01ZZ-AAA55L49](#)  
[LL01CR-AYG24R49](#) [LL01A00CZMB2-M2](#) [LL01ED-AKY38R49](#) [LL01CR-CNE2545L06-M2](#) [LL01ZZ-AAA38L49](#) [LL01ED-AKV36R49](#)  
[LL01ED-ALI24R49](#) [LL01CR-AYG38R49](#) [C17171\\_DAISSY-8X1-SHD-MATT](#) [F16859\\_LINDA-ZT25](#) [C17295\\_ILONA-ZOOM](#)  
[F16636\\_LINDA-W60](#) [C17362\\_DAISSY-7X1-W-D](#) [C17361\\_DAISSY-7X1-WW-D](#) [10003](#) [10003/15](#) [10048](#) [10049](#) [10108](#) [10510](#)  
[F14487\\_FLORENCE-1R-MAXI-WG](#) [12667](#) [C14165\\_STRADA-2X2-ME-WIDE2](#) [C14605\\_HB-2X2-RW](#) [C14642\\_FLORENCE-1R-UP](#)  
[CAY033](#) [CAY046/55](#) [FCX11157\\_RES-O-90](#) [OS-LRI2015X45S](#) [OSOLRA2015M](#) [PG1C-NX36](#) [PG1C-SX17](#) [PM2A-SXV1](#) [PM2B-NX55-](#)  
[AW](#) [PM6A-FN25](#) [FC2231-0000-0050-L](#) [FC2231-0000-0100-L](#) [C14116\\_STRADA-2X2-PX](#)