

STRADA-B2

Wide oval beam for area lighting

TECHNICAL SPECIFICATIONS:

Dimensions	19.6 x 15.5 mm
Height	5.2 mm
Fastening	glue, pin, screw
ROHS compliant	yes ⓘ



MATERIAL SPECIFICATIONS:

Component	Type	Material	Colour	Finish
STRADA-B2	Single lens	PMMA	clear	

ORDERING INFORMATION:

Component	Qty in box	MOQ	MPQ	Box weight (kg)
C10949_STRADA-B2 » Box size: 480 x 280 x 300 mm	2880	288	144	4.2

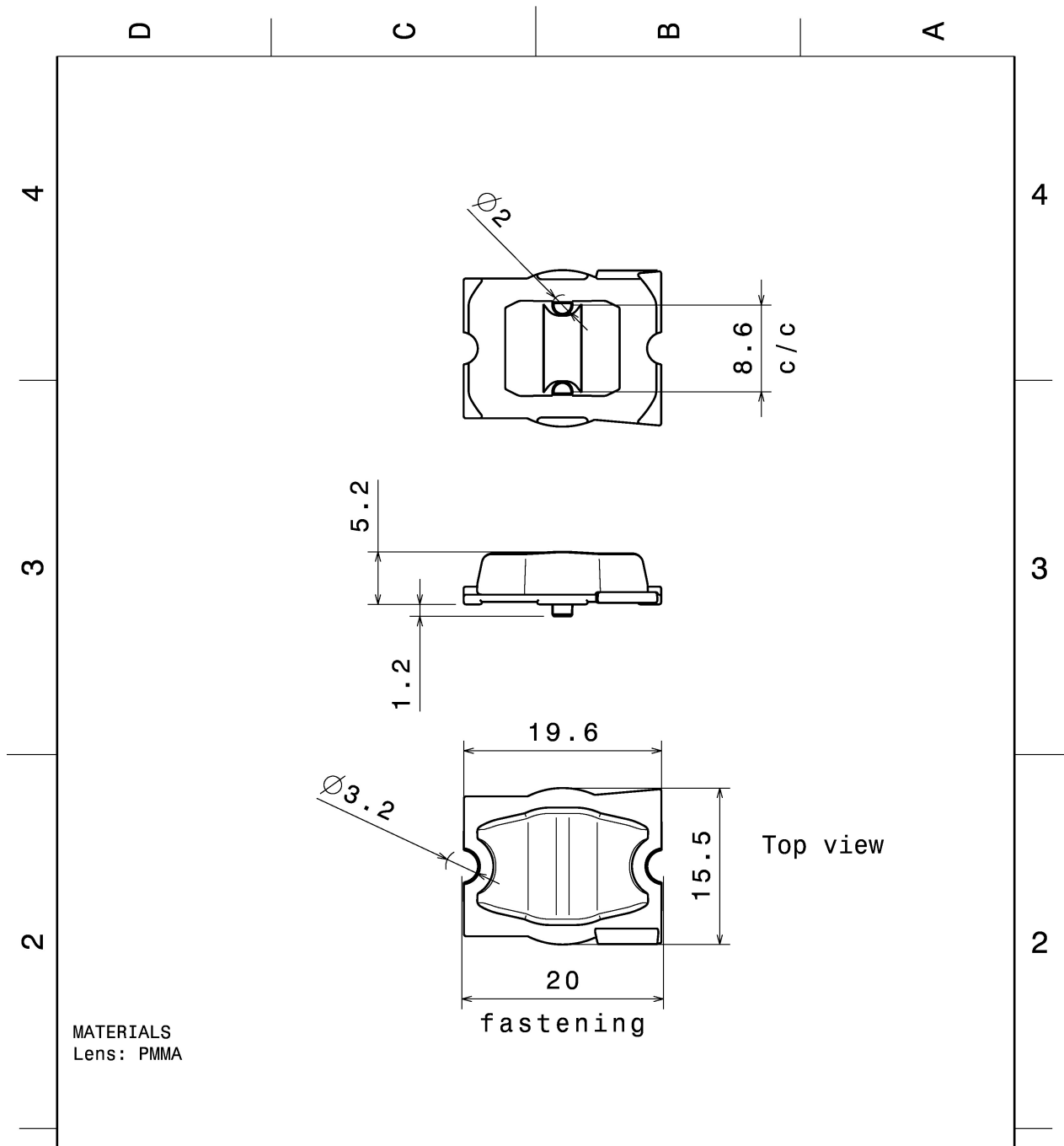

MATERIALS
Lens: PMMA

This drawing is our property. It can't be reproduced or communicated without our written agreement.

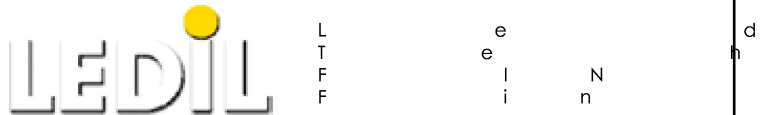

DRAWN BY p		DATE 13.08.2009	DRAWING TITLE Datasheet Strada-B2-XP lens		
CHECKED BY i k	DATE 12.06.2009	SIZE A4	DRAWING NUMBER C10949	REV 1	
DESIGNED BY hh	DATE 12.06.2009	SCALE 2:1	WEIGHT (g)	SHEET 1/1	

See also our general installation guide: www.ledil.com/installation_guide

PHOTOMETRIC DATA (MEASURED):

CREE LED

LED XB-D
 FWHM / FWTM 112.0 + 46.0°
 Efficiency 94 %
 Peak intensity 0.6 cd/lm
 LEDs/each optic 1
 Light colour White
 Required components:

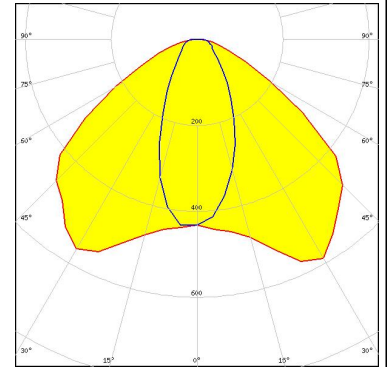

CREE LED

LED XP-E
 FWHM / FWTM 116.0 + 44.0°
 Efficiency 92 %
 Peak intensity 0.5 cd/lm
 LEDs/each optic 1
 Light colour White
 Required components:

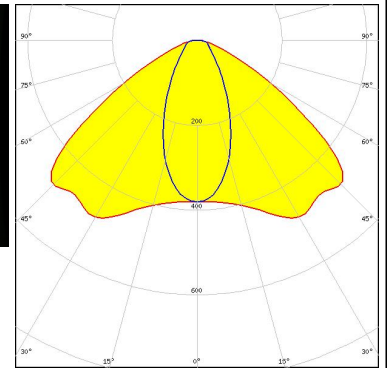
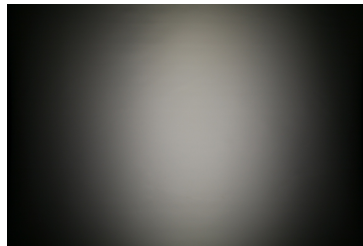

CREE LED

LED XP-G
 FWHM / FWTM 112.0 + 42.0°
 Efficiency 92 %
 LEDs/each optic 1
 Light colour White
 Required components:

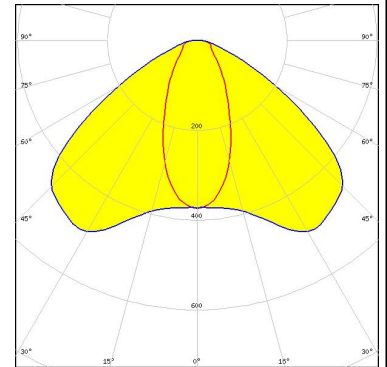

LUMILEDS

LED LUXEON A
 FWHM / FWTM 112.0 + 52.0°
 Efficiency 92 %
 LEDs/each optic 1
 Light colour White
 Required components:

PHOTOMETRIC DATA (MEASURED):

LUMILEDS

LED LUXEON Rebel
 FWHM / FWTM 108.0 + 46.0°
 Efficiency 92 %
 Peak intensity 0.5 cd/lm
 LEDs/each optic 1
 Light colour White
 Required components:

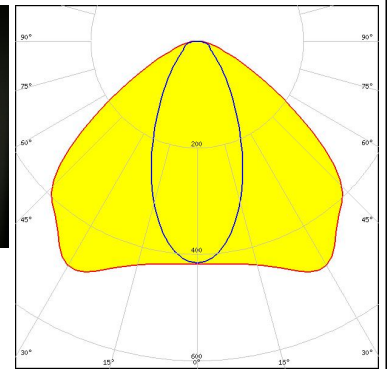
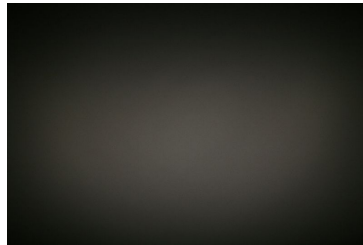

LUMILEDS

LED LUXEON Rebel ES
 FWHM / FWTM 112.0 + 52.0°
 Efficiency 92 %
 Peak intensity 0.5 cd/lm
 LEDs/each optic 1
 Light colour White
 Required components:

NICHIA

LED NCSxx19A
 FWHM / FWTM 108.0 + 48.0°
 Efficiency 92 %
 LEDs/each optic 1
 Light colour White
 Required components:

NICHIA

LED NVSxx19A
 FWHM / FWTM 108.0 + 48.0°
 Efficiency 92 %
 LEDs/each optic 1
 Light colour White
 Required components:

PHOTOMETRIC DATA (MEASURED):

OSRAM Opto Semiconductors

LED OSLON SSL 150
FWHM / FWTM 110.0 + 50.0°
Efficiency 92 %
LEDs/each optic 1
Light colour White
Required components:

OSRAM Opto Semiconductors

LED OSLON SSL 80
FWHM / FWTM 110.0 + 50.0°
Efficiency 92 %
Peak intensity 0.4 cd/lm
LEDs/each optic 1
Light colour White
Required components:

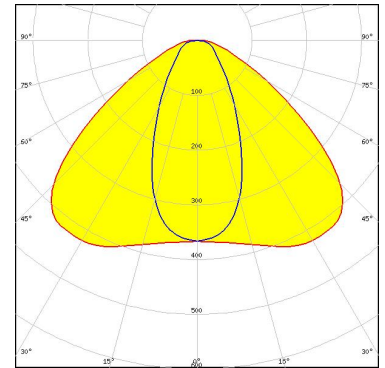

SHARP

LED Double Dome (GM2BB)
FWHM / FWTM 116.0 + 48.0°
Efficiency 92 %
LEDs/each optic 1
Light colour White
Required components:

PHOTOMETRIC DATA (SIMULATED):



LED	NVSxx19B/NVSxx19C
FWHM / FWTM	114.0 + 34.0° / 144.0 + 77.0°
Efficiency	94 %
Peak intensity	0.6 cd/lm
LEDs/each optic	1
Light colour	White
Required components:	

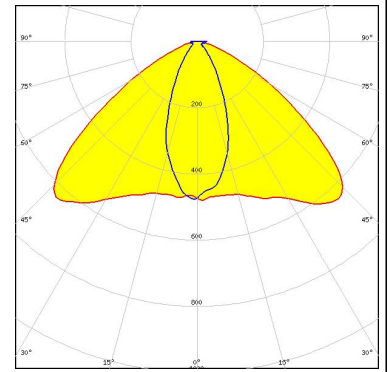

GENERAL INFORMATION:

NOTE: The typical beam angle will be changed by different color, chip size and chip position tolerance. The typical total beam angle is the full angle measured where the luminous intensity is half of the peak value.

MATERIALS:

As part of our continuous research and improvement processes, and to ensure the best possible quality and availability of our products, LEDiL reserves the right to change material grades without notice.

PRODUCT DATA USER AGREEMENT AND DISCLAIMER:

The measured data in the provided downloadable LEDiL Product Datasheets and Mechanical 2D-Drawings is rounded and provided as reference for planning. LEDiL Oy's optical specifications have been verified by conducting performance testing of the products in accordance with the company's quality system. The reported data are averaged results of multiple measurements with typical variation. LEDiL Oy reserves the right to without prior notification make changes and improvements to its products.

LEDiL Oy assumes neither warranty, nor guarantee nor any other liability of any kind for the contents and correctness of the provided data. The provided data has been generated with highest diligence but the provided data may in reality not represent the complete possible variation range of all intrinsic parameters. Therefore, in certain cases a deviation from the provided data could occur.

LEDiL Oy reserves the right to undertake technical changes of its products without further notification which could lead to changes in the provided data. LEDiL Oy assumes no liability of any kind for the possible deviation from any provided data or any other damage resulting from the usage of the provided data.

The user agrees to this disclaimer and user agreement with the download or usage of the provided files.

LEDiL Oy

Joensuunkatu 13
FI-24240 SALO
Finland

LEDiL Inc.

228 West Page Street
Suite D
Sycamore IL 60178
USA

Ledil Optics Technology (Shenzhen) Co., Ltd.

405 , Block B
Casic Motor Building
Shenzhen 518057
P.R.CHINA

Local sales and technical support

[www.ledil.com/
where_to_buy](http://www.ledil.com/where_to_buy)

Shipping locations

Salo, Finland
Hong Kong, China

Distribution Partners

[www.ledil.com/
where_to_buy](http://www.ledil.com/where_to_buy)

X-ON Electronics

Largest Supplier of Electrical and Electronic Components

Click to view similar products for [LED Lighting Lenses](#) category:

Click to view products by [Ledil](#) manufacturer:

Other Similar products are found below :

[LL01ED-AK40L06](#) [LL01ZZ-EX25L06-M2](#) [180182-0000](#) [LL01ED-ALI55R49](#) [C14707_IDA16-O](#) [C12231_LENA-FRESNEL-LENS](#)
[LL01ED-AKY24R49](#) [LL01CR-AYG15R49](#) [LL01CR-OT32L06-M2](#) [LL01ZZ-AAA24L49](#) [LL01CR-CEN38L02](#) [LL01ZZ-AAA55L49](#)
[LL01CR-AYG24R49](#) [LL01A00CZMB2-M2](#) [LL01ED-AKY38R49](#) [LL01CR-CNE2545L06-M2](#) [LL01ZZ-AAA38L49](#) [LL01ED-AKV36R49](#)
[LL01ED-ALI24R49](#) [LL01CR-AYG38R49](#) [C17171_DAISSY-8X1-SHD-MATT](#) [F16859_LINDA-ZT25](#) [C17295_ILONA-ZOOM](#)
[F16636_LINDA-W60](#) [C17362_DAISSY-7X1-W-D](#) [C17361_DAISSY-7X1-WW-D](#) [10003](#) [10003/15](#) [10048](#) [10049](#) [10108](#) [10510](#)
[F14487_FLORENCE-1R-MAXI-WG](#) [12667](#) [C14165_STRADA-2X2-ME-WIDE2](#) [C14605_HB-2X2-RW](#) [C14642_FLORENCE-1R-UP](#)
[CAY033](#) [CAY046/55](#) [FCX11157_RES-O-90](#) [OS-LRI2015X45S](#) [OSOLRA2015M](#) [PG1C-NX36](#) [PG1C-SX17](#) [PM2A-SXV1](#) [PM2B-NX55-](#)
[AW](#) [PM6A-FN25](#) [FC2231-0000-0050-L](#) [FC2231-0000-0100-L](#) [C14116_STRADA-2X2-PX](#)