

MIRELLA-50-M

~30° medium beam

TECHNICAL SPECIFICATIONS:

Dimensions	Ø 49.9 mm
Height	23.9 mm
Fastening	glue
ROHS compliant	yes ⓘ

MATERIAL SPECIFICATIONS:

Component	Type	Material	Colour	Finish	Coating
MIRELLA-50-M	Reflector	PC	metal		lacquer

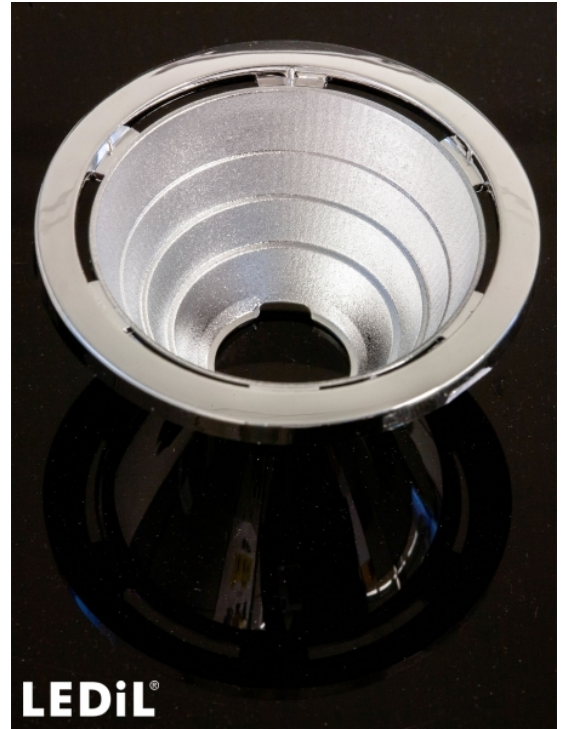

ORDERING INFORMATION:

Component	Qty in box	MOQ	MPQ	Box weight (kg)
C12477_MIRELLA-50-M » Box size: 480 x 280 x 300 mm	336	112	28	2.8

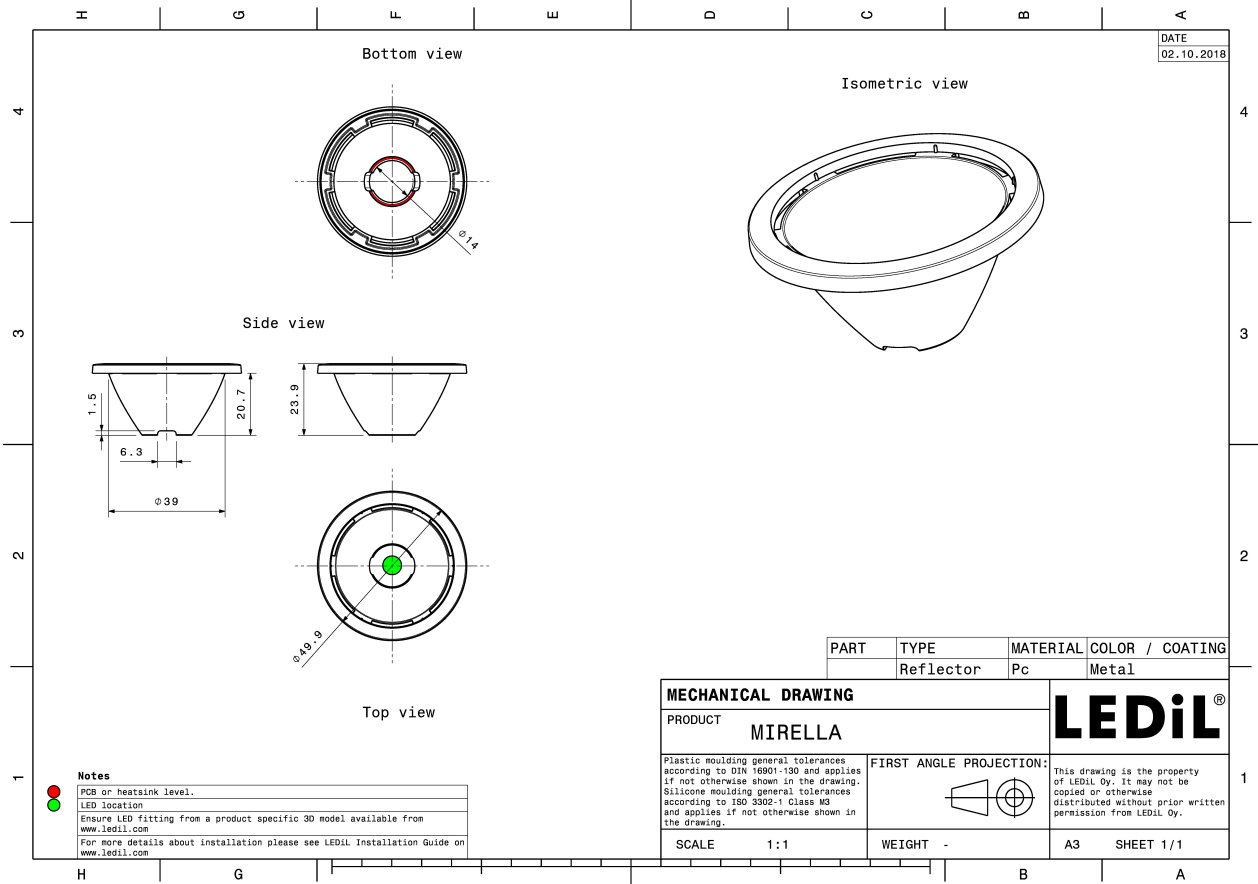

See also our general installation guide: www.ledil.com/installation_guide

PHOTOMETRIC DATA (MEASURED):

bridgelux.

LED	BXRA LS
FWHM / FWTM	27.0° / 64.0°
Efficiency	89 %
Peak intensity	2.8 cd/lm
LEDs/each optic	1
Light colour	White

Required components:



bridgelux.

LED	BXRA LS
FWHM / FWTM	27.0° / 69.0°
Efficiency	84 %
Peak intensity	2.4 cd/lm
LEDs/each optic	1
Light colour	White

Required components:
C13333_MIRELLA-CL



bridgelux.

LED	BXRA LS
FWHM / FWTM	35.0° / 73.0°
Efficiency	83 %
Peak intensity	1.6 cd/lm
LEDs/each optic	1
Light colour	White

Required components:
C12479_MIRELLA-DL



CITIZEN

LED	CLL01x
FWHM / FWTM	39.0° / 77.0°
Efficiency	%
LEDs/each optic	1
Light colour	White

Required components:
C12479_MIRELLA-DL



PHOTOMETRIC DATA (MEASURED):

CITIZEN

LED CLL01x
 FWHM / FWTM 35.0° / 76.0°
 Efficiency 83 %
 Peak intensity 1.7 cd/lm
 LEDs/each optic 1
 Light colour White
 Required components:
 C13333_MIRELLA-CL



CITIZEN

LED CLL01x
 FWHM / FWTM 29.0° / 77.0°
 Efficiency %
 Peak intensity 3.2 cd/lm
 LEDs/each optic 1
 Light colour White
 Required components:

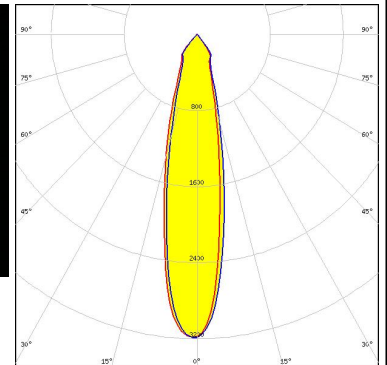
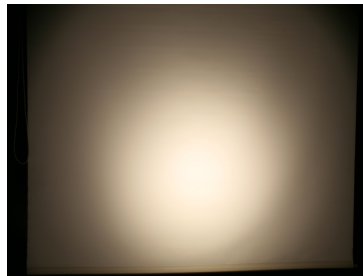

CITIZEN

LED CLL02x/CLU02x (LES10)
 FWHM / FWTM 30.0° / 71.0°
 Efficiency 88 %
 Peak intensity 2.4 cd/lm
 LEDs/each optic 1
 Light colour White
 Required components:

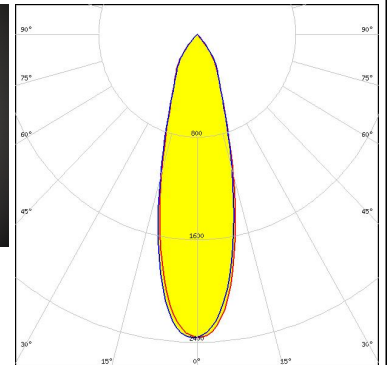
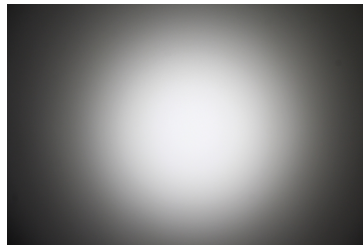

CITIZEN

LED CLL02x/CLU02x (LES10)
 FWHM / FWTM 37.0° / 75.0°
 Efficiency 82 %
 Peak intensity 1.6 cd/lm
 LEDs/each optic 1
 Light colour White
 Required components:
 C13723_MIRELLA-RZL

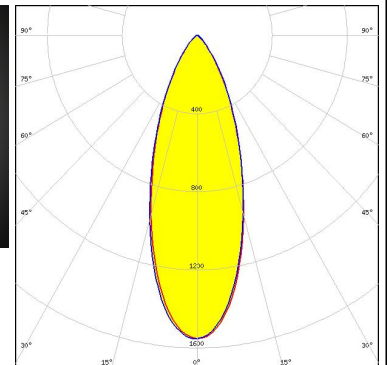
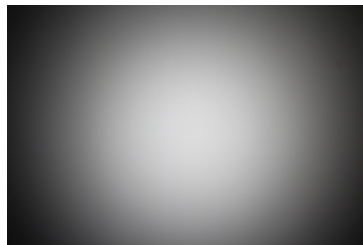

PHOTOMETRIC DATA (MEASURED):

CITIZEN

LED CLL02x/CLU02x (LES10)
 FWHM / FWTM 30.0° / 71.0°
 Efficiency 84 %
 Peak intensity 2.2 cd/lm
 LEDs/each optic 1
 Light colour White
 Required components:
 C13333_MIRELLA-CL

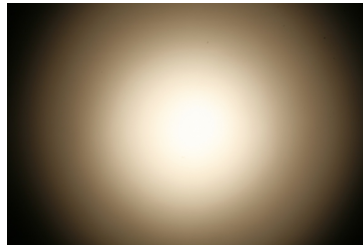

CITIZEN

LED CLL02x/CLU02x (LES10)
 FWHM / FWTM 35.0° / 73.0°
 Efficiency 82 %
 Peak intensity 1.7 cd/lm
 LEDs/each optic 1
 Light colour White
 Required components:
 C12479_MIRELLA-DL

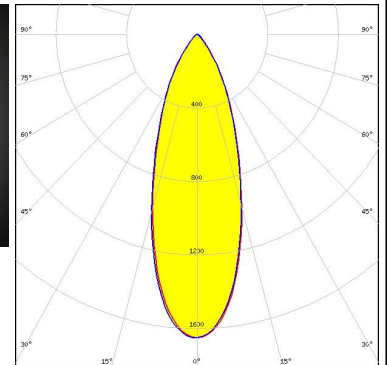
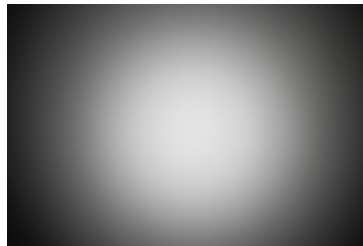

CITIZEN

LED CLU700/701/702
 FWHM / FWTM 22.0° / 51.0°
 Efficiency 90 %
 Peak intensity 3.5 cd/lm
 LEDs/each optic 1
 Light colour White
 Required components:

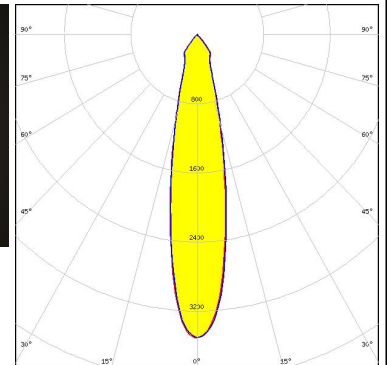
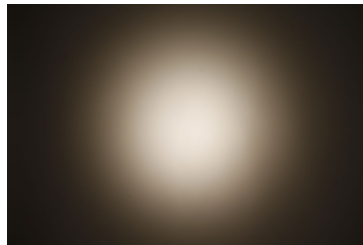

CITIZEN

LED CLU700/701/702
 FWHM / FWTM 33.0° / 70.0°
 Efficiency 82 %
 Peak intensity 1.7 cd/lm
 LEDs/each optic 1
 Light colour White
 Required components:
 C13723_MIRELLA-RZL

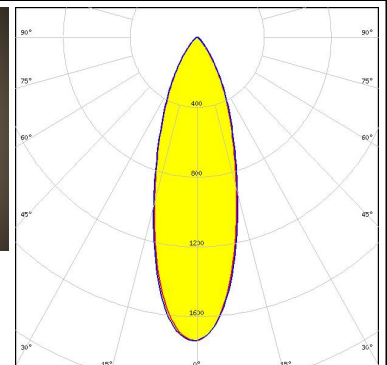
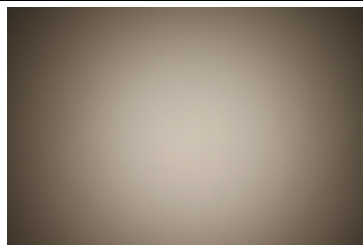

PHOTOMETRIC DATA (MEASURED):

CITIZEN

LED CLU700/701/702
 FWHM / FWTM 24.0° / 64.0°
 Efficiency 83 %
 Peak intensity 2.9 cd/m
 LEDs/each optic 1
 Light colour White
 Required components:
 C13333_MIRELLA-CL

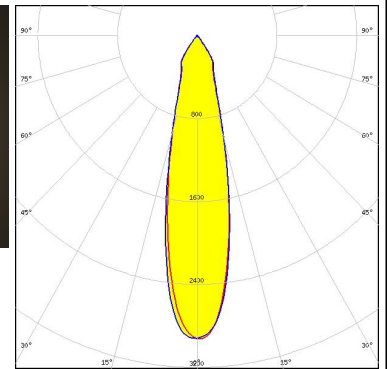
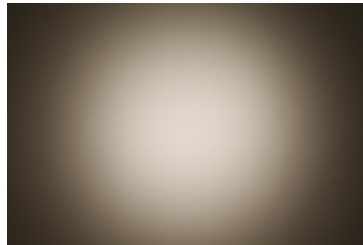

CITIZEN

LED CLU700/701/702
 FWHM / FWTM 29.0° / 69.0°
 Efficiency 84 %
 Peak intensity 2.2 cd/m
 LEDs/each optic 1
 Light colour White
 Required components:
 C12479_MIRELLA-DL

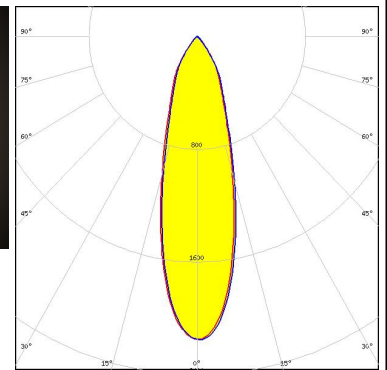
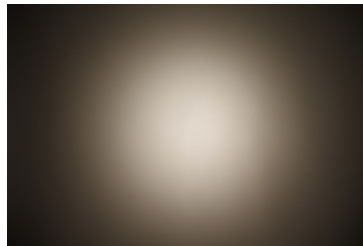

CITIZEN

LED CLU710/711
 FWHM / FWTM 26.0° / 70.0°
 Efficiency 90 %
 Peak intensity 2.6 cd/m
 LEDs/each optic 1
 Light colour White
 Required components:

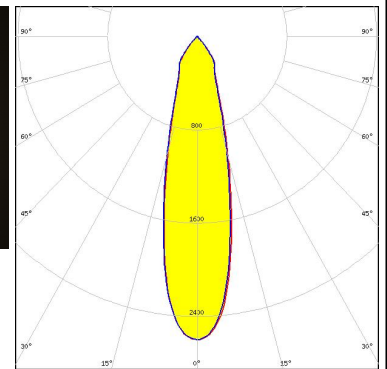
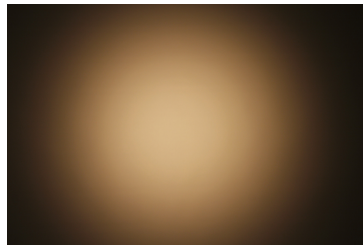

CITIZEN

LED CLU710/711
 FWHM / FWTM 38.0° / 76.0°
 Efficiency 83 %
 Peak intensity 1.4 cd/m
 LEDs/each optic 1
 Light colour White
 Required components:
 C13723_MIRELLA-RZL

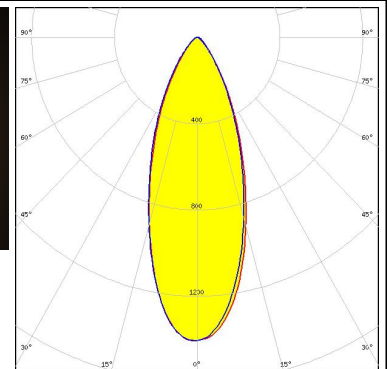
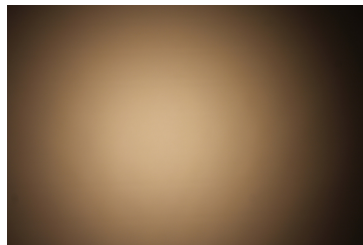

PHOTOMETRIC DATA (MEASURED):

CITIZEN

LED CLU710/711
 FWHM / FWTM 30.0° / 70.0°
 Efficiency 85 %
 Peak intensity 2.1 cd/lm
 LEDs/each optic 1
 Light colour White
 Required components:
 C13333_MIRELLA-CL

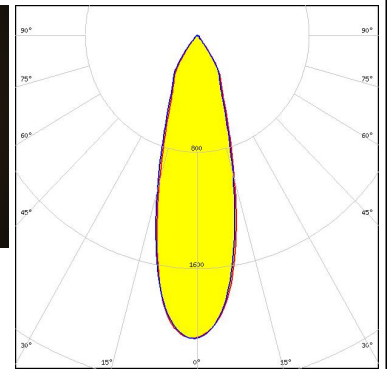

CITIZEN

LED CLU710/711
 FWHM / FWTM 35.0° / 74.0°
 Efficiency 81 %
 Peak intensity 1.5 cd/lm
 LEDs/each optic 1
 Light colour White
 Required components:
 C12479_MIRELLA-DL

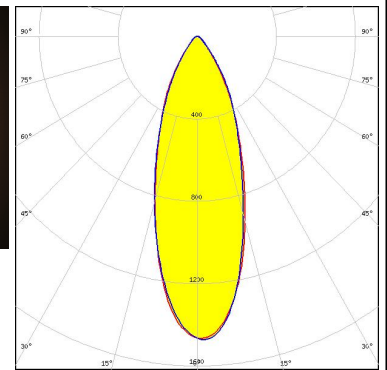
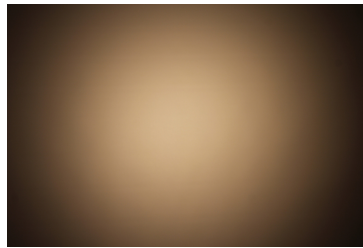

CITIZEN

LED CLU720/721
 FWHM / FWTM 31.0° / 75.0°
 Efficiency 90 %
 Peak intensity 2 cd/lm
 LEDs/each optic 1
 Light colour White
 Required components:

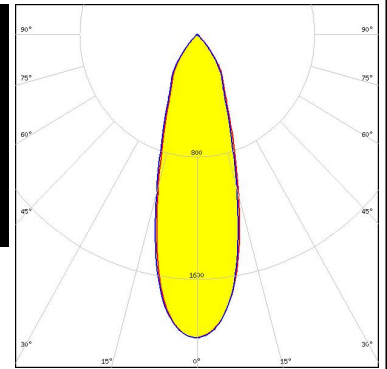
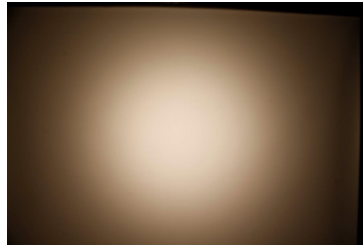

CITIZEN

LED CLU720/721
 FWHM / FWTM 39.0° / 77.0°
 Efficiency 83 %
 Peak intensity 1.4 cd/lm
 LEDs/each optic 1
 Light colour White
 Required components:
 C13723_MIRELLA-RZL

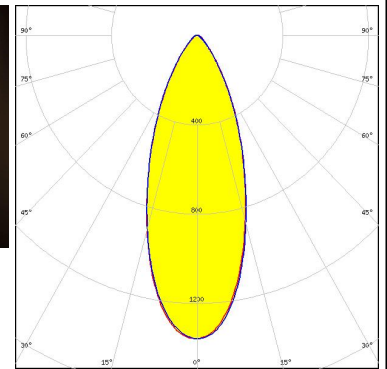
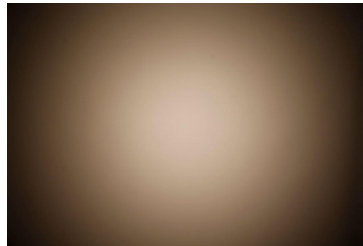

PHOTOMETRIC DATA (MEASURED):

CITIZEN

LED CLU720/721
 FWHM / FWTM 35.0° / 73.0°
 Efficiency 85 %
 Peak intensity 1.7 cd/m
 LEDs/each optic 1
 Light colour White
 Required components:
 C13333_MIRELLA-CL

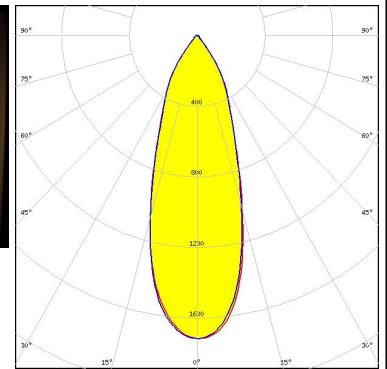
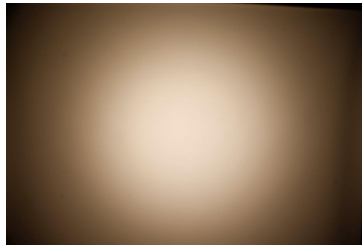

CITIZEN

LED CLU720/721
 FWHM / FWTM 38.0° / 76.0°
 Efficiency 82 %
 Peak intensity 1.4 cd/m
 LEDs/each optic 1
 Light colour White
 Required components:
 C12479_MIRELLA-DL

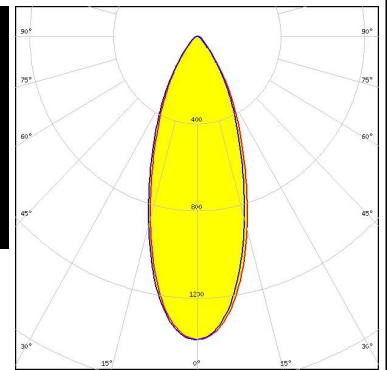
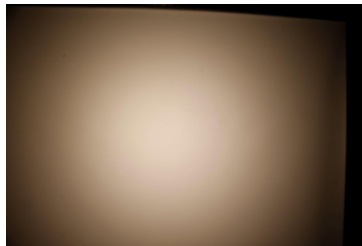

LED CXA/B 13xx
 FWHM / FWTM 23.0° / 68.0°
 Efficiency 81 %
 Peak intensity 2.9 cd/m
 LEDs/each optic 1
 Light colour White
 Required components:
 C13333_MIRELLA-CL



LED CXA/B 13xx
 FWHM / FWTM 26.0° / 67.0°
 Efficiency 80 %
 Peak intensity 2.4 cd/m
 LEDs/each optic 1
 Light colour White
 Required components:
 C12479_MIRELLA-DL



PHOTOMETRIC DATA (MEASURED):

CREE LED

LED CXA/B 13xx
 FWHM / FWTM 20.0° / 55.0°
 Efficiency 85 %
 Peak intensity 3.7 cd/lm
 LEDs/each optic 1
 Light colour White
 Required components:



CREE LED

LED CXA/B 15xx
 FWHM / FWTM 28.0° / 72.0°
 Efficiency 92 %
 Peak intensity 2.5 cd/lm
 LEDs/each optic 1
 Light colour White
 Required components:

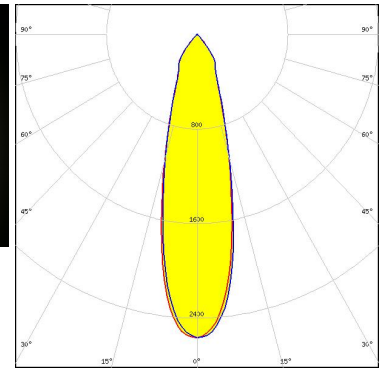

CREE LED

LED CXA/B 15xx
 FWHM / FWTM 30.0° / 71.0°
 Efficiency 83 %
 Peak intensity 2.4 cd/lm
 LEDs/each optic 1
 Light colour White
 Required components:
 C13333_MIRELLA-CL

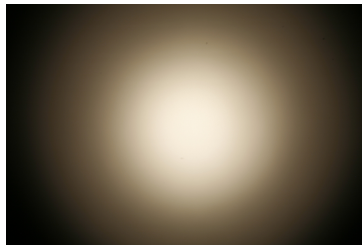

CREE LED

LED CXA/B 15xx
 FWHM / FWTM 34.0° / 72.0°
 Efficiency 89 %
 Peak intensity 1.7 cd/lm
 LEDs/each optic 1
 Light colour White
 Required components:
 C12479_MIRELLA-DL

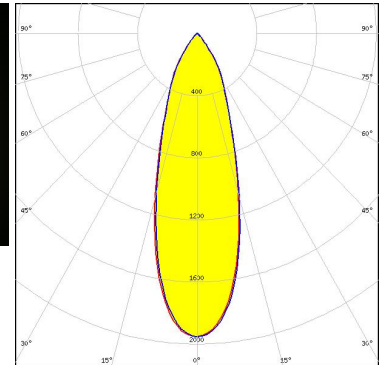
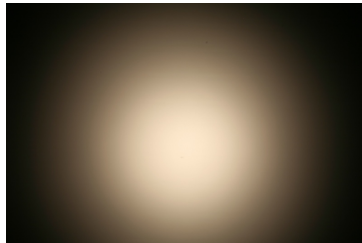

PHOTOMETRIC DATA (MEASURED):



LED CXA/B 1816 & CXA/B 1820 & CXA 1850
 FWHM / FWTM 37.0° / 76.0°
 Efficiency 82 %
 Peak intensity 1.8 cd/lm
 LEDs/each optic 1
 Light colour White
 Required components:
 C13333_MIRELLA-CL

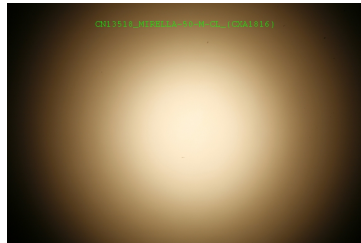

LED CXA/B 1816 & CXA/B 1820 & CXA 1850
 FWHM / FWTM 39.0° / 76.0°
 Efficiency 83 %
 Peak intensity 1.6 cd/lm
 LEDs/each optic 1
 Light colour White
 Required components:
 C12479_MIRELLA-DL

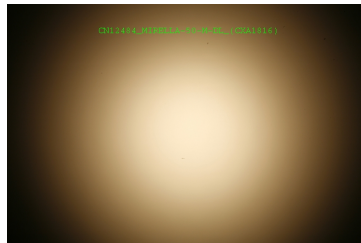



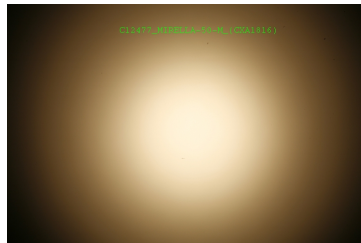

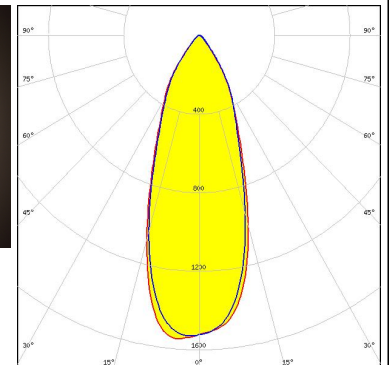
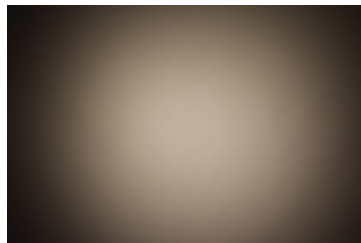

LED CXA/B 1816 & CXA/B 1820 & CXA 1850
 FWHM / FWTM 34.0° / 78.0°
 Efficiency 88 %
 Peak intensity 2 cd/lm
 LEDs/each optic 1
 Light colour White
 Required components:

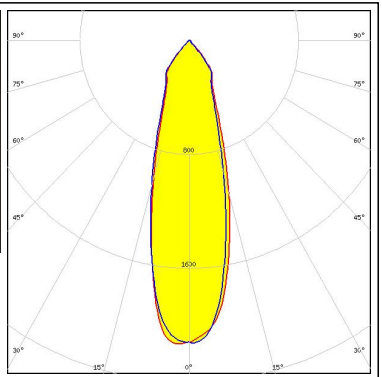

LED MHD-E/G
 FWHM / FWTM 37.0° / 76.0°
 Efficiency 88 %
 Peak intensity 1.5 cd/lm
 LEDs/each optic 1
 Light colour White
 Required components:
 C12479_MIRELLA-DL

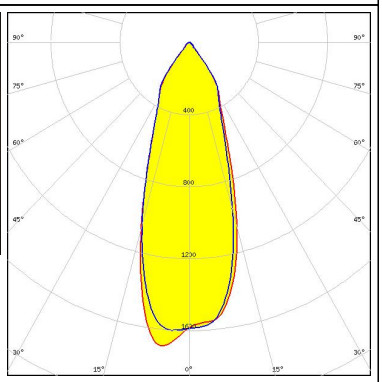

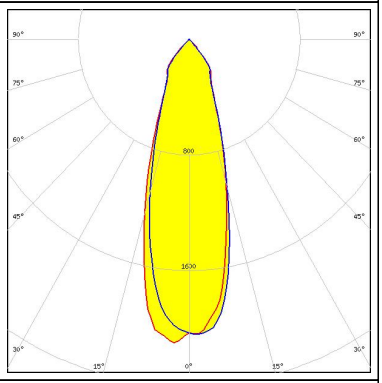
PHOTOMETRIC DATA (MEASURED):

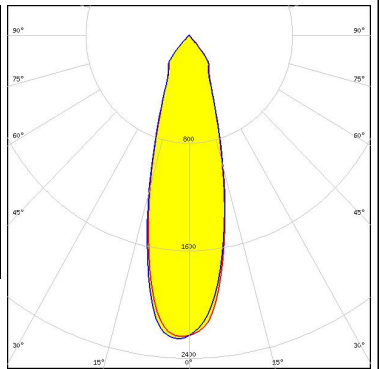
<p>CREE → LED</p> <p>LED MHD-E/G FWHM / FWTM 30.0° / 79.0° Efficiency 93 % Peak intensity 2.1 cd/m LEDs/each optic 1 Light colour White Required components:</p>		
<p>CREE → LED</p> <p>LED MHD-E/G FWHM / FWTM 35.0° / 76.0° Efficiency 88 % Peak intensity 1.7 cd/m LEDs/each optic 1 Light colour White Required components: C13333_MIRELLA-CL</p>		
<p>CREE → LED</p> <p>LED MT-G FWHM / FWTM 31.0° / 78.5° Efficiency 91 % Peak intensity 2.1 cd/m LEDs/each optic 1 Light colour White Required components:</p>		
<p>CREE → LED</p> <p>LED MT-G2 FWHM / FWTM 30.0° / 78.0° Efficiency 90 % Peak intensity 2.3 cd/m LEDs/each optic 1 Light colour White Required components:</p>		

PHOTOMETRIC DATA (MEASURED):

CREE LED

LED MT-G2
 FWHM / FWTM 35.0° / 77.0°
 Efficiency 85 %
 Peak intensity 1.8 cd/lm
 LEDs/each optic 1
 Light colour White
 Required components:
 C13333_MIRELLA-CL



CREE LED

LED MT-G2
 FWHM / FWTM 38.0° / 77.0°
 Efficiency 83 %
 Peak intensity 1.7 cd/lm
 LEDs/each optic 1
 Light colour White
 Required components:
 C12479_MIRELLA-DL

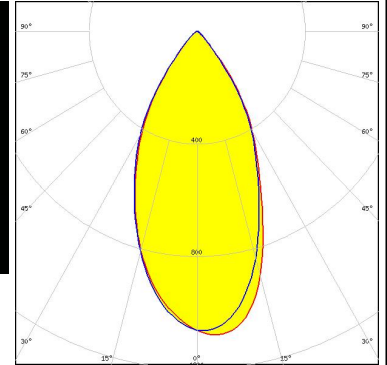

CREE LED

LED XHP50
 FWHM / FWTM 33.0° / 74.0°
 Efficiency 86 %
 Peak intensity 1.8 cd/lm
 LEDs/each optic 1
 Light colour White
 Required components:
 C12479_MIRELLA-DL

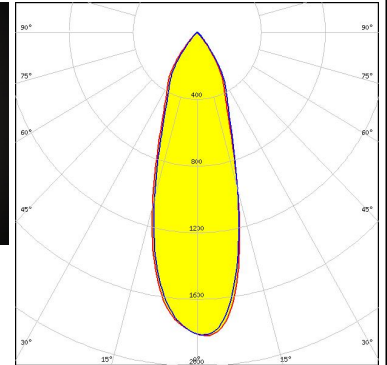
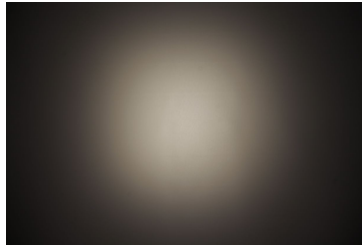





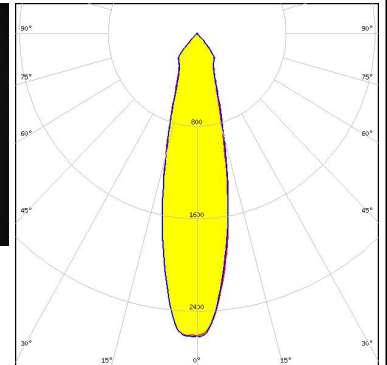
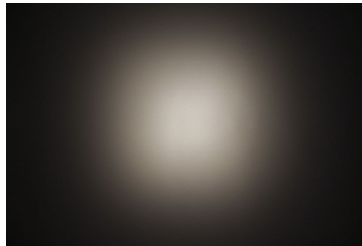

CREE LED

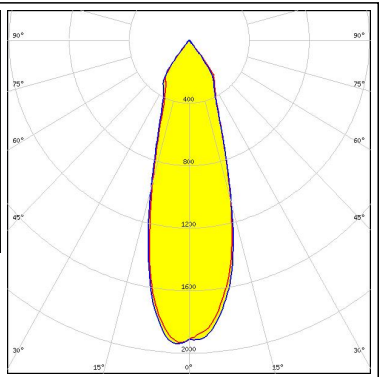

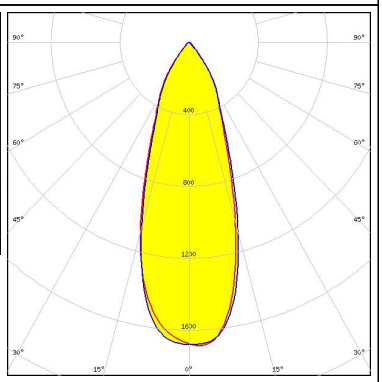

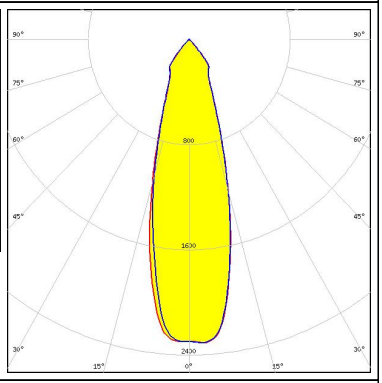
LED XHP50
 FWHM / FWTM 25.0° / 76.0°
 Efficiency 91 %
 Peak intensity 2.6 cd/lm
 LEDs/each optic 1
 Light colour White
 Required components:

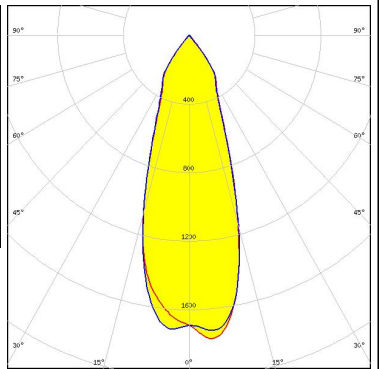

PHOTOMETRIC DATA (MEASURED):

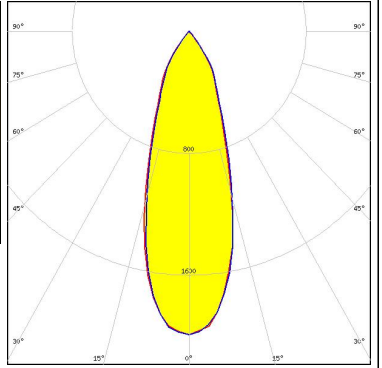
<p>CREE ⇄ LED</p> <p>LED XHP50 FWHM / FWTM 31.0° / 75.0° Efficiency 86 % Peak intensity 2 cd/lm LEDs/each optic 1 Light colour White Required components: C13333_MIRELLA-CL</p>		
<p>CREE ⇄ LED</p> <p>LED XHP70 FWHM / FWTM 36.0° / 74.0° Efficiency 87 % Peak intensity 1.7 cd/lm LEDs/each optic 1 Light colour White Required components: C12479_MIRELLA-DL</p>		
<p>CREE ⇄ LED</p> <p>LED XHP70 FWHM / FWTM 30.0° / 77.0° Efficiency 91 % Peak intensity 2.3 cd/lm LEDs/each optic 1 Light colour White Required components:</p>		
<p>CREE ⇄ LED</p> <p>LED XHP70 FWHM / FWTM 35.0° / 76.0° Efficiency 86 % Peak intensity 1.8 cd/lm LEDs/each optic 1 Light colour White Required components: C13333_MIRELLA-CL</p>		

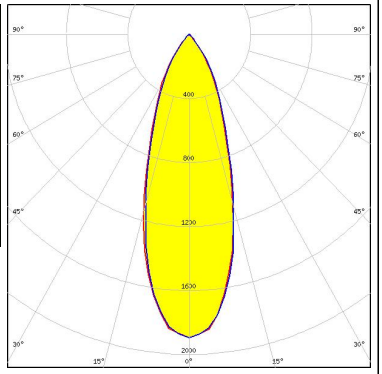
PHOTOMETRIC DATA (MEASURED):

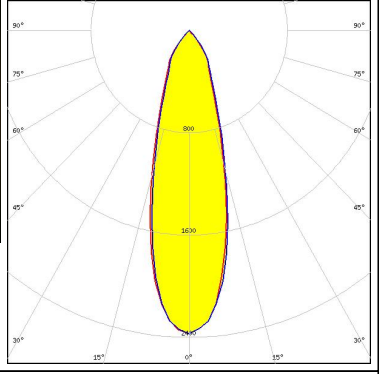
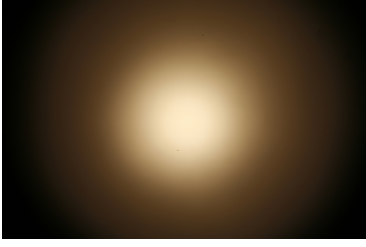
<p>LUMILEDS</p> <p>LED LUXEON CoB 1202/1203</p> <p>FWHM / FWTM 33.0° / 72.0°</p> <p>Efficiency 85 %</p> <p>Peak intensity 2 cd/m</p> <p>LEDs/each optic 1</p> <p>Light colour White</p> <p>Required components: C13333_MIRELLA-CL</p>		
<p>LUMILEDS</p> <p>LED LUXEON CoB 1202/1203</p> <p>FWHM / FWTM 35.0° / 71.0°</p> <p>Efficiency 85 %</p> <p>Peak intensity 1.9 cd/m</p> <p>LEDs/each optic 1</p> <p>Light colour White</p> <p>Required components: C12479_MIRELLA-DL</p>		
<p>LUMILEDS</p> <p>LED LUXEON CoB 1202/1203</p> <p>FWHM / FWTM 29.0° / 72.0°</p> <p>Efficiency 89 %</p> <p>Peak intensity 2.4 cd/m</p> <p>LEDs/each optic 1</p> <p>Light colour White</p> <p>Required components:</p>		
<p>LUMILEDS</p> <p>LED LUXEON S1000</p> <p>FWHM / FWTM 22.0° / 64.0°</p> <p>Efficiency 83 %</p> <p>Peak intensity 3.4 cd/m</p> <p>LEDs/each optic 1</p> <p>Light colour White</p> <p>Required components: C13333_MIRELLA-CL</p>		

PHOTOMETRIC DATA (MEASURED):



LED LUXEON S1000
 FWHM / FWTM 22.0° / 66.0°
 Efficiency %
 LEDs/each optic 1
 Light colour White
 Required components:



LED LUXEON S1000
 FWHM / FWTM 28.0° / 68.0°
 Efficiency %
 LEDs/each optic 1
 Light colour White
 Required components:
 C12479_MIRELLA-DL

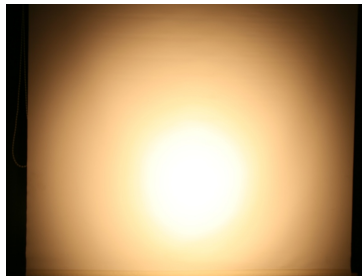

LED CxM-9 (13.5x13.5)
 FWHM / FWTM 33.0° / 72.0°
 Efficiency 85 %
 Peak intensity 1.9 cd/lm
 LEDs/each optic 1
 Light colour White
 Required components:
 C13333_MIRELLA-CL

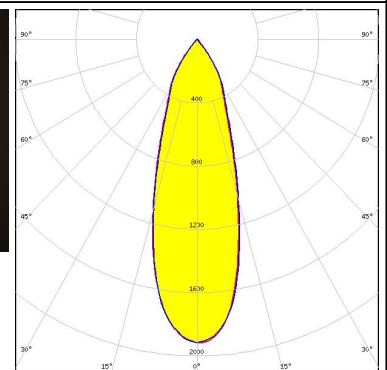
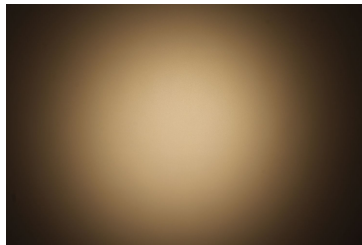

LED CxM-9 (13.5x13.5)
 FWHM / FWTM 34.0° / 72.0°
 Efficiency 85 %
 Peak intensity 1.7 cd/lm
 LEDs/each optic 1
 Light colour White
 Required components:
 C12479_MIRELLA-DL

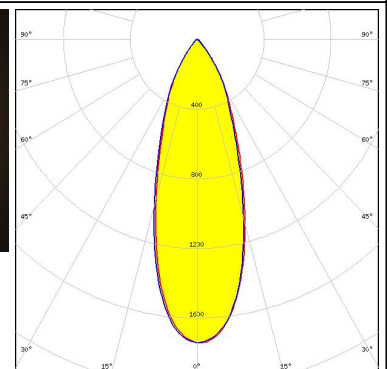
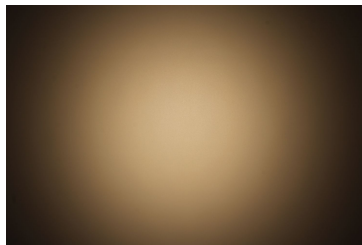

PHOTOMETRIC DATA (MEASURED):



LED CxM-9 (13.5x13.5)
 FWHM / FWTM 29.0° / 73.0°
 Efficiency 90 %
 Peak intensity 2.3 cd/lm
 LEDs/each optic 1
 Light colour White
 Required components:

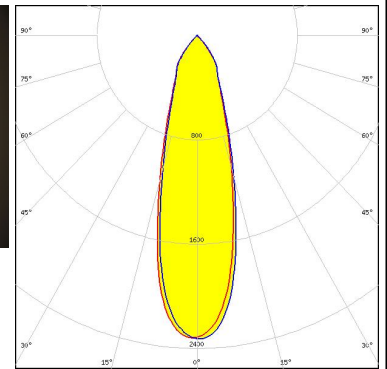
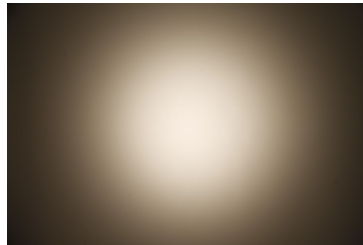

LED COB L-Type (LES 9)
 FWHM / FWTM 29.0° / 72.0°
 Efficiency 90 %
 Peak intensity 2.4 cd/lm
 LEDs/each optic 1
 Light colour White
 Required components:

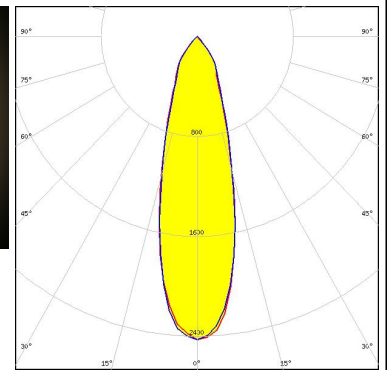
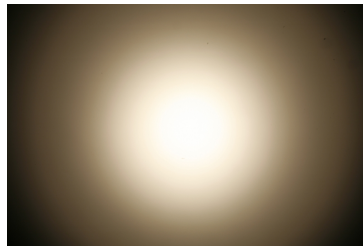

LED COB L-Type (LES 9)
 FWHM / FWTM 33.0° / 71.0°
 Efficiency 86 %
 Peak intensity 2.1 cd/lm
 LEDs/each optic 1
 Light colour White
 Required components:
 C13333_MIRELLA-CL

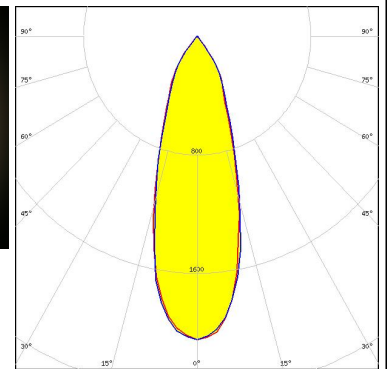
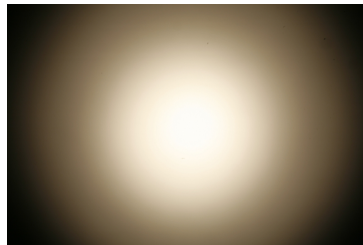

LED COB L-Type (LES 9)
 FWHM / FWTM 34.0° / 71.0°
 Efficiency 84 %
 Peak intensity 1.9 cd/lm
 LEDs/each optic 1
 Light colour White
 Required components:
 C12479_MIRELLA-DL

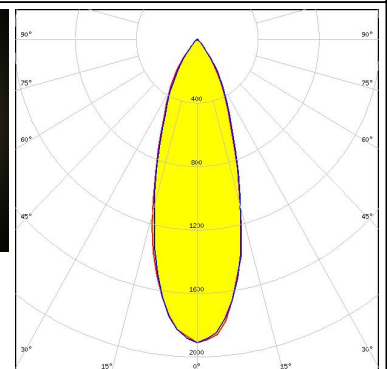
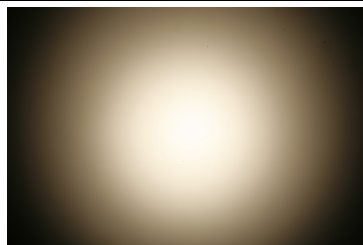

PHOTOMETRIC DATA (MEASURED):



LED NFMW48xA
 FWHM / FWTM 21.0° / 53.0°
 Efficiency 82 %
 Peak intensity 3.3 cd/lm
 LEDs/each optic 1
 Light colour White
 Required components:

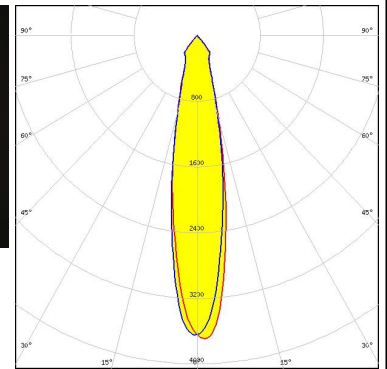
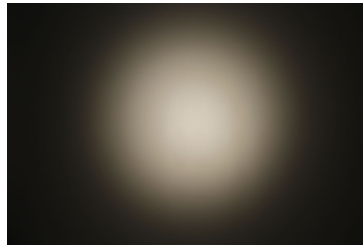

LED NSCxL036A
 FWHM / FWTM 26.0° / 64.0°
 Efficiency 88 %
 Peak intensity 2.8 cd/lm
 LEDs/each optic 1
 Light colour White
 Required components:

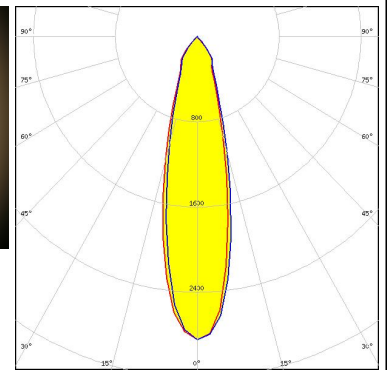

LED NSCxL036A
 FWHM / FWTM 30.0° / 70.0°
 Efficiency 85 %
 Peak intensity 2.3 cd/lm
 LEDs/each optic 1
 Light colour White
 Required components:
 C13333_MIRELLA-CL

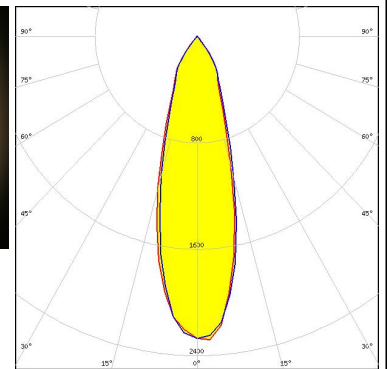
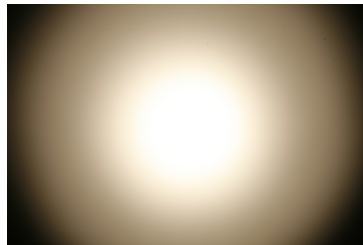



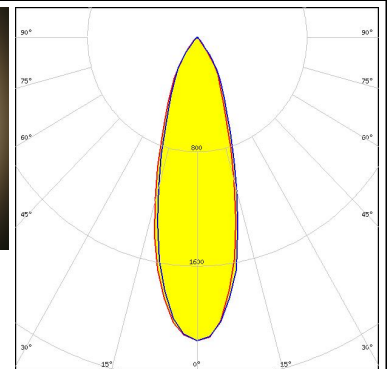

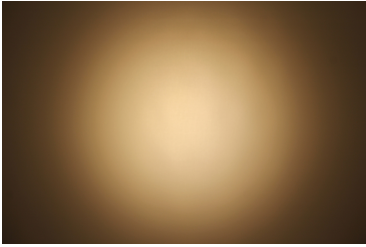
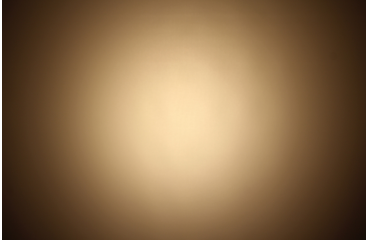
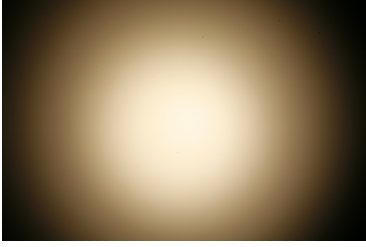
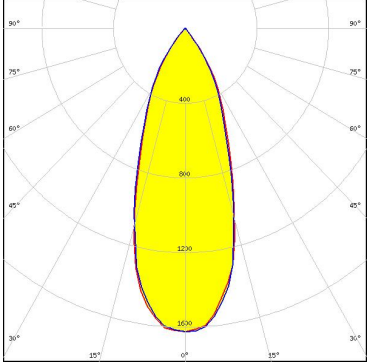

LED NSCxL036A
 FWHM / FWTM 32.0° / 70.0°
 Efficiency 85 %
 Peak intensity 2.1 cd/lm
 LEDs/each optic 1
 Light colour White
 Required components:
 C12479_MIRELLA-DL



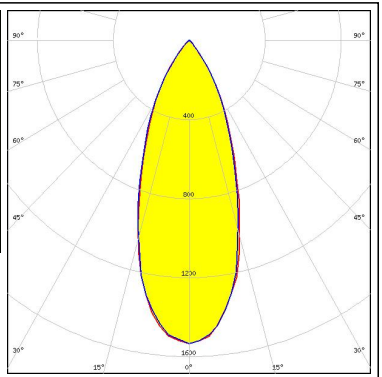

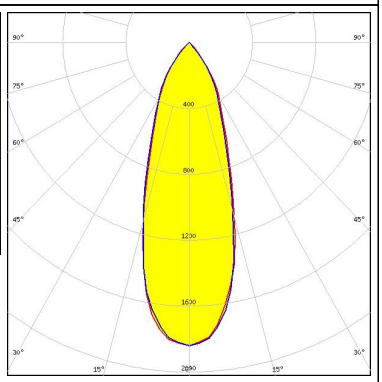

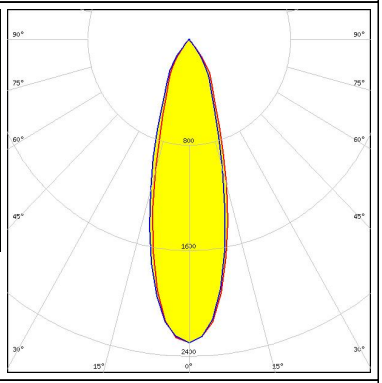
PHOTOMETRIC DATA (MEASURED):

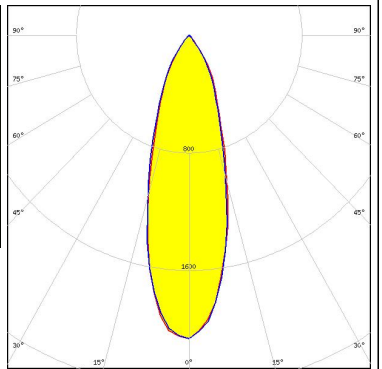
<p>OSRAM Opto Semiconductors</p> <p>LED Duris S10</p> <p>FWHM / FWTM 24.0° / 63.0°</p> <p>Efficiency 88 %</p> <p>Peak intensity 3.3 cd/m</p> <p>LEDs/each optic 1</p> <p>Light colour White</p> <p>Required components:</p>	
<p>OSRAM Opto Semiconductors</p> <p>LED Duris S10</p> <p>FWHM / FWTM 29.0° / 71.0°</p> <p>Efficiency 83 %</p> <p>Peak intensity 2.5 cd/m</p> <p>LEDs/each optic 1</p> <p>Light colour White</p> <p>Required components: C13333_MIRELLA-CL</p>	
<p>OSRAM Opto Semiconductors</p> <p>LED Duris S10</p> <p>FWHM / FWTM 32.0° / 72.0°</p> <p>Efficiency 81 %</p> <p>Peak intensity 1.9 cd/m</p> <p>LEDs/each optic 1</p> <p>Light colour White</p> <p>Required components: C12479_MIRELLA-DL</p>	
<p>OSRAM Opto Semiconductors</p> <p>LED Soleriq S13</p> <p>FWHM / FWTM 38.0° / 74.0°</p> <p>Efficiency 82 %</p> <p>Peak intensity 1.6 cd/m</p> <p>LEDs/each optic 1</p> <p>Light colour White</p> <p>Required components: C13333_MIRELLA-CL</p>	 

PHOTOMETRIC DATA (MEASURED):

<p>OSRAM Opto Semiconductors</p> <p>LED Soleriq S13</p> <p>FWHM / FWTM 39.0° / 75.0°</p> <p>Efficiency 81 %</p> <p>Peak intensity 1.5 cd/lm</p> <p>LEDs/each optic 1</p> <p>Light colour White</p> <p>Required components: C12479_MIRELLA-DL</p>		
<p>OSRAM Opto Semiconductors</p> <p>LED Soleriq S13</p> <p>FWHM / FWTM 35.0° / 76.0°</p> <p>Efficiency 87 %</p> <p>Peak intensity 1.8 cd/lm</p> <p>LEDs/each optic 1</p> <p>Light colour White</p> <p>Required components:</p>		
<p>SEOUL SEMICONDUCTOR</p> <p>LED ZC4/6</p> <p>FWHM / FWTM 30.0° / 69.0°</p> <p>Efficiency 82 %</p> <p>Peak intensity 2.3 cd/lm</p> <p>LEDs/each optic 1</p> <p>Light colour White</p> <p>Required components: C13333_MIRELLA-CL</p>		
<p>SEOUL SEMICONDUCTOR</p> <p>LED ZC4/6</p> <p>FWHM / FWTM 32.0° / 70.0°</p> <p>Efficiency 83 %</p> <p>Peak intensity 2.1 cd/lm</p> <p>LEDs/each optic 1</p> <p>Light colour White</p> <p>Required components: C12479_MIRELLA-DL</p>		

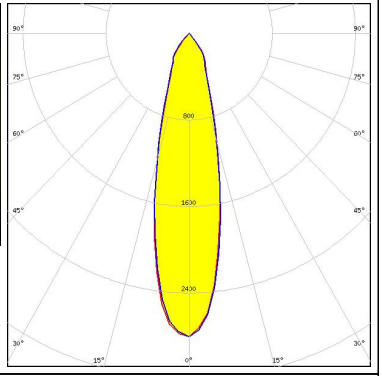
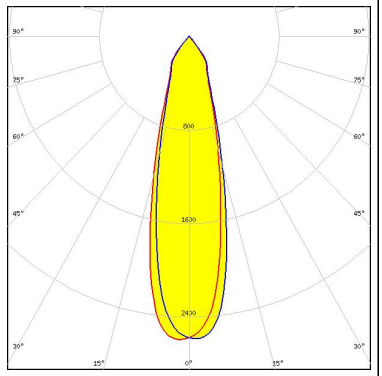
PHOTOMETRIC DATA (MEASURED):

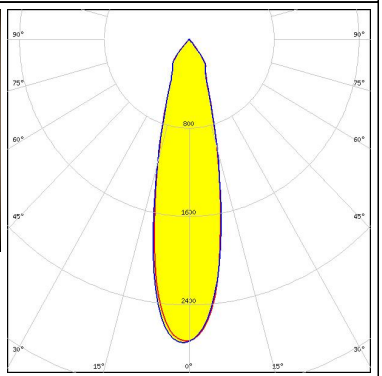
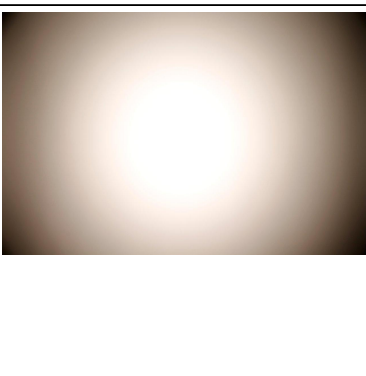
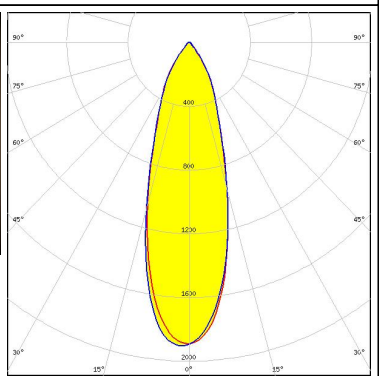
<p> SEOL SEMICONDUCTOR</p> <p>LED ZC4/6</p> <p>FWHM / FWTM 26.0° / 66.0°</p> <p>Efficiency 87 %</p> <p>Peak intensity 2.8 cd/lm</p> <p>LEDs/each optic 1</p> <p>Light colour White</p> <p>Required components:</p>		
<p>SHARP</p> <p>LED Mini Zenigata (GW5BM)</p> <p>FWHM / FWTM 29.0° / 71.0°</p> <p>Efficiency 90 %</p> <p>Peak intensity 2.7 cd/lm</p> <p>LEDs/each optic 1</p> <p>Light colour White</p> <p>Required components:</p>		
<p>SHARP</p> <p>LED Mini Zenigata (GW6BM)</p> <p>FWHM / FWTM 25.0° / 73.0°</p> <p>Efficiency 90 %</p> <p>Peak intensity 2.7 cd/lm</p> <p>LEDs/each optic 1</p> <p>Light colour White</p> <p>Required components:</p>		
<p>SHARP</p> <p>LED Mini Zenigata (GW6BM)</p> <p>FWHM / FWTM 30.0° / 70.0°</p> <p>Efficiency 83 %</p> <p>Peak intensity 1.9 cd/lm</p> <p>LEDs/each optic 1</p> <p>Light colour White</p> <p>Required components: C12479_MIRELLA-DL</p>		

PHOTOMETRIC DATA (SIMULATED):

<p>bridgelux.</p> <p>LED: Vero SE 10 FWHM / FWTM: 22.0° / 64.0° Efficiency: 91 % Peak intensity: 3.1 cd/lm LEDs/each optic: 1 Light colour: White Required components:</p>	
<p>LUMILEDS</p> <p>LED: LUXEON 7070 FWHM / FWTM: 26.0° / 52.0° Efficiency: 96 % Peak intensity: 3.3 cd/lm LEDs/each optic: 1 Light colour: White Required components:</p>	
<p>OSRAM <small>Opto Semiconductors</small></p> <p>LED: OSCONIQ P 7070 FWHM / FWTM: 25.0° / 59.0° Efficiency: 91 % Peak intensity: 3 cd/lm LEDs/each optic: 1 Light colour: White Required components:</p>	
<p>OSRAM <small>Opto Semiconductors</small></p> <p>LED: Soleriq S9 FWHM / FWTM: 34.0° / 71.0° Efficiency: 87 % Peak intensity: 2 cd/lm LEDs/each optic: 1 Light colour: White Required components: C13333_MIRELLA-CL</p>	

PHOTOMETRIC DATA (SIMULATED):

OSRAM

Opto Semiconductors

LED Soleriq S9
FWHM / FWTM 35.0° / 71.0°
Efficiency 85 %
Peak intensity 1.9 cd/lm
LEDs/each optic 1
Light colour White
Required components:
C12479_MIRELLA-DL

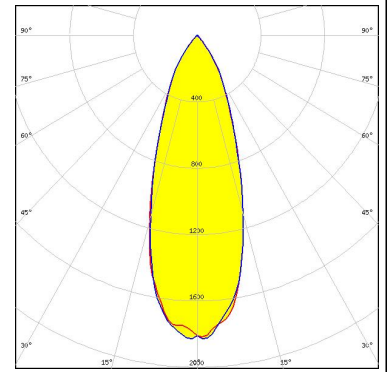

OSRAM

Opto Semiconductors

LED Soleriq S9
FWHM / FWTM 31.0° / 73.0°
Efficiency 91 %
Peak intensity 2.3 cd/lm
LEDs/each optic 1
Light colour White
Required components:

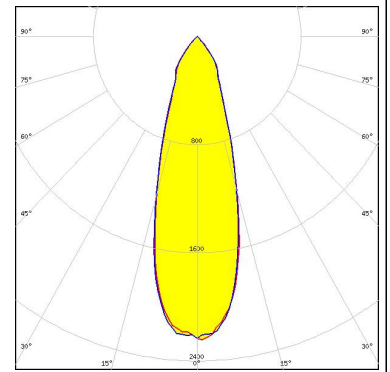

GENERAL INFORMATION:

NOTE: The typical beam angle will be changed by different color, chip size and chip position tolerance. The typical total beam angle is the full angle measured where the luminous intensity is half of the peak value.

Due to use of high power COB's with this product, special attention to proper thermal design is highly recommended. LEDiL has no liability for direct, indirect or consecutive damages arising from the LEDiL products being used outside of the recommended temperature range.

MATERIALS:

As part of our continuous research and improvement processes, and to ensure the best possible quality and availability of our products, LEDiL reserves the right to change material grades without notice.

PRODUCT DATA USER AGREEMENT AND DISCLAIMER:

The measured data in the provided downloadable LEDiL Product Datasheets and Mechanical 2D-Drawings is rounded and provided as reference for planning. LEDiL Oy's optical specifications have been verified by conducting performance testing of the products in accordance with the company's quality system. The reported data are averaged results of multiple measurements with typical variation. LEDiL Oy reserves the right to without prior notification make changes and improvements to its products.

LEDiL Oy assumes neither warranty, nor guarantee nor any other liability of any kind for the contents and correctness of the provided data. The provided data has been generated with highest diligence but the provided data may in reality not represent the complete possible variation range of all intrinsic parameters. Therefore, in certain cases a deviation from the provided data could occur.

LEDiL Oy reserves the right to undertake technical changes of its products without further notification which could lead to changes in the provided data. LEDiL Oy assumes no liability of any kind for the possible deviation from any provided data or any other damage resulting from the usage of the provided data.

The user agrees to this disclaimer and user agreement with the download or usage of the provided files.

LEDiL Oy

Joensuunkatu 13
FI-24240 SALO
Finland

LEDiL Inc.

228 West Page Street
Suite D
Sycamore IL 60178
USA

Ledil Optics Technology (Shenzhen) Co., Ltd.

405 , Block B
Casic Motor Building
Shenzhen 518057
P.R.CHINA

Local sales and technical support

[www.ledil.com/
where_to_buy](http://www.ledil.com/where_to_buy)

Shipping locations

Salo, Finland
Hong Kong, China

Distribution Partners

[www.ledil.com/
where_to_buy](http://www.ledil.com/where_to_buy)

X-ON Electronics

Largest Supplier of Electrical and Electronic Components

Click to view similar products for [LED Lighting Reflectors](#) category:

Click to view products by [Ledil](#) manufacturer:

Other Similar products are found below :

[LL04CR-CFN35155L02](#) [LL04CR-CFN60155L02](#) [LL04CR-CGM85135L02](#) [F13185_GERI-RZ](#) [10604](#) [LL01SP-ATH15R49](#) [10170](#) [12527](#)
[12531](#) [12568](#) [C13253_TINA2-R-CLIP16](#) [CA14591_BROOKE-XW](#) [F15560_MIRELLA-G2-W](#) [CA11525_LAURA-R-W](#) [12796](#) [LMH020-](#)
[REFL-0000-0000062](#) [LMH020-REFL-0000-0000082](#) [C12606_LENINA-DL](#) [CN12711_LENINA-W-DL](#) [C11394_TYRA-S](#) [C11396_TYRA-](#)
[W](#) [C11508_BROOKE-W](#) [C11552_BARBARA-S](#) [C11553_BARBARA-W](#) [C11862_MINNIE-W](#) [C11979_LENA-S](#) [C11980_LENA-W](#)
[C11996_LENA-LENS](#) [C12083_BROOKE-SCR-M](#) [C12095_MINNIE-M](#) [C12097_MINNIE-WWW](#) [C12154_LENA-M](#) [C12469_LISA2-R-](#)
[PIN](#) [C12476_MIRELLA-50-S](#) [C12477_MIRELLA-50-M](#) [C12480_MIRELLA-50-S-PIN](#) [C12516_RITA-WAS](#) [C12597_LENINA-S](#)
[C12599_LENINA-W](#) [C12948_LENA-WAS](#) [C12958_LENINA-XW](#) [C13085_MIRELLA-50-S-PF](#) [C13087_MIRELLA-50-W-PF](#)
[C13101_LENA-X-WAS](#) [C13555_BRIDGET-W-UNI](#) [C13556_BRIDGET-M-UNI](#) [C13557_BRIDGET-S-UNI](#) [C14346_ANGELETTE-WAS](#)
[C17099_ALISE-50-DL](#) [C17095_ALISE-70-CL](#)