

## MIRELLA-50-S-PIN

~15° spot beam

### TECHNICAL SPECIFICATIONS:

Dimensions	Ø 49.9 mm
Height	23.9 mm
Fastening	pin
ROHS compliant	yes ⓘ

### MATERIAL SPECIFICATIONS:

Component	Type	Material	Colour	Finish	Coating
MIRELLA-50-S-PIN	Reflector	PC	metal		lacquer







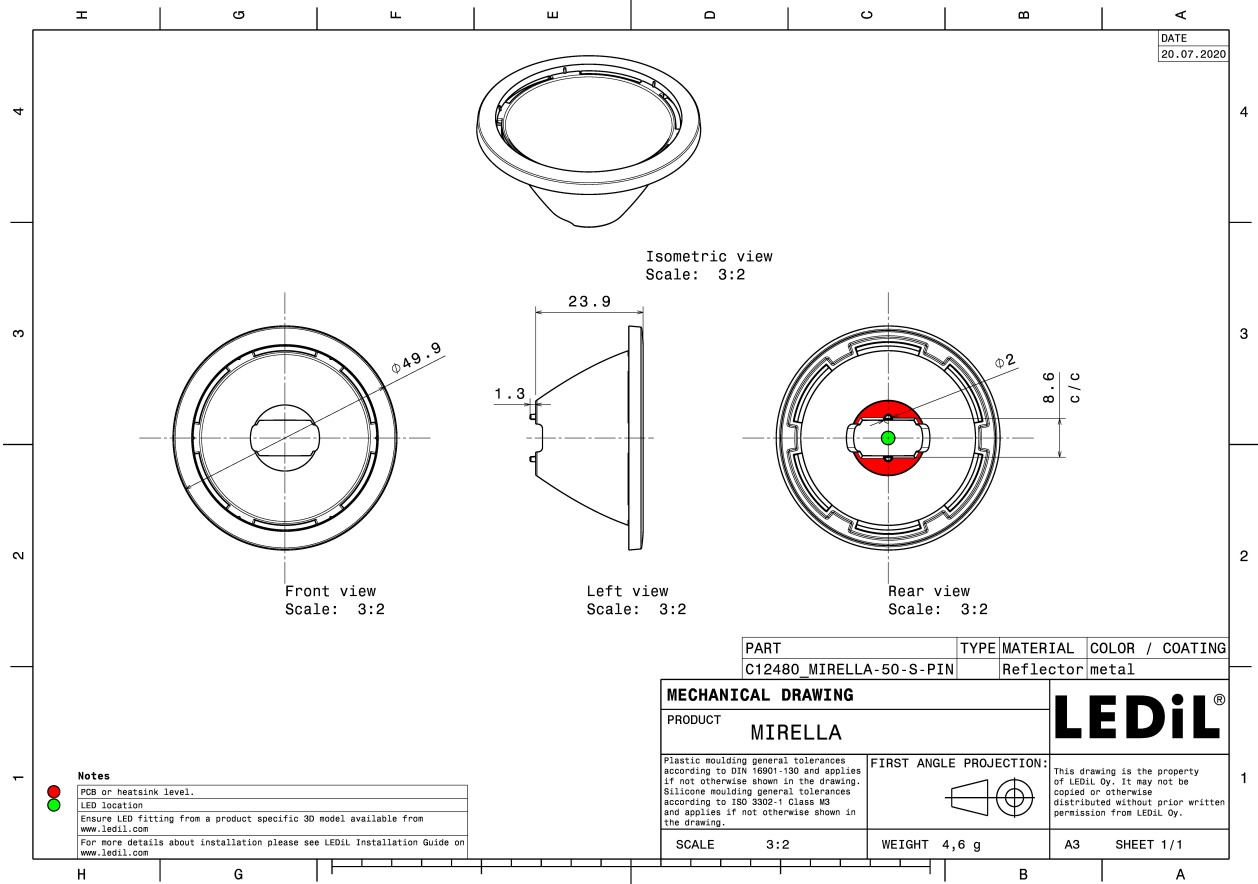

### ORDERING INFORMATION:

Component	Qty in box	MOQ	MPQ	Box weight (kg)
C12480_MIRELLA-50-S-PIN » Box size: 480 x 280 x 300 mm	336	112	28	3.0

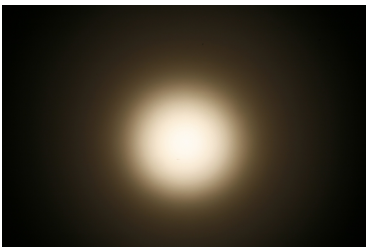

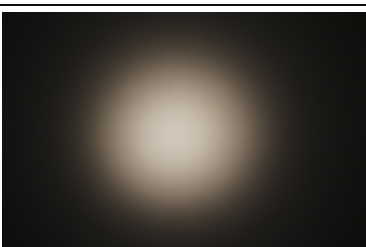
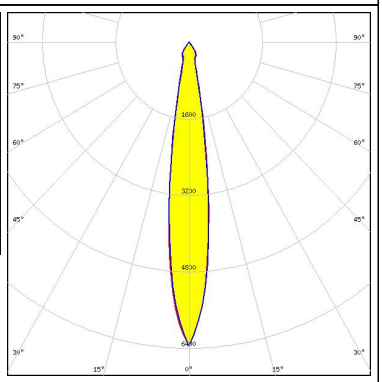

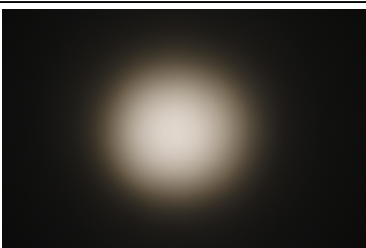

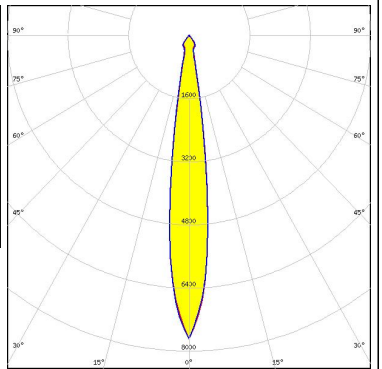

See also our general installation guide: [www.ledil.com/installation\\_guide](http://www.ledil.com/installation_guide)

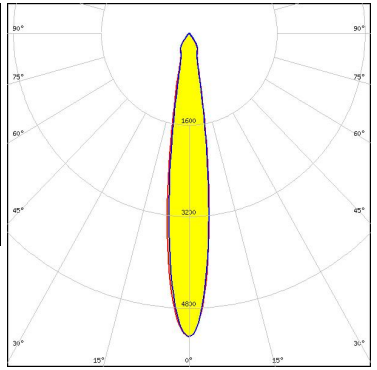
#### PHOTOMETRIC DATA (MEASURED):

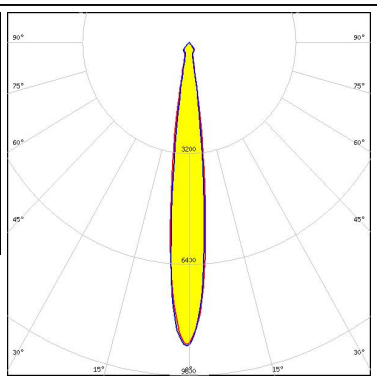
<p></p> <p>LED SM4            FWHM / FWTM 15.0° / 32.0°            Efficiency 81 %            Peak intensity 6.9 cd/m            LEDs/each optic 1            Light colour White            Required components:            C12479_MIRELLA-DL</p>		
<p></p> <p>LED MHB-A/B            FWHM / FWTM 17.0° / 38.0°            Efficiency 85 %            Peak intensity 5.4 cd/m            LEDs/each optic 1            Light colour White            Required components:            C12479_MIRELLA-DL</p>		
<p></p> <p>LED MHB-A/B            FWHM / FWTM 14.0° / 28.0°            Efficiency 90 %            Peak intensity 9.4 cd/m            LEDs/each optic 1            Light colour White            Required components:</p>		
<p></p> <p>LED MHB-A/B            FWHM / FWTM 16.0° / 32.0°            Efficiency 85 %            Peak intensity 7 cd/m            LEDs/each optic 1            Light colour White            Required components:            C13333_MIRELLA-CL</p>		

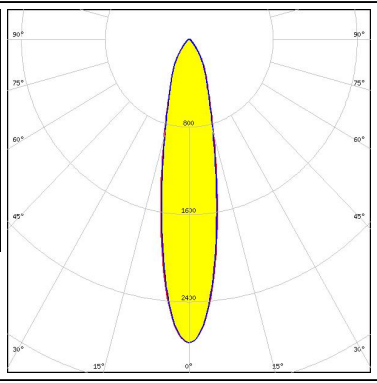
#### PHOTOMETRIC DATA (MEASURED):

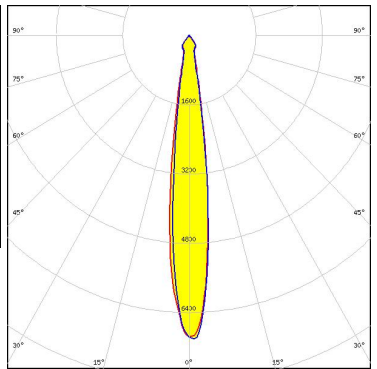
<p><b>CREE</b> → <b>LED</b></p> <p>LED XHP50            FWHM / FWTM 16.0° / 35.0°            Efficiency 89 %            Peak intensity 5.3 cd/lm            LEDs/each optic 1            Light colour White            Required components:            C12479_MIRELLA-DL</p>		
<p><b>CREE</b> → <b>LED</b></p> <p>LED XHP50            FWHM / FWTM 13.0° / 24.0°            Efficiency 93 %            Peak intensity 8.8 cd/lm            LEDs/each optic 1            Light colour White            Required components:</p>		
<p><b>CREE</b> → <b>LED</b></p> <p>LED XHP50            FWHM / FWTM 22.0° / 60.0°            Efficiency 86 %            Peak intensity 2.8 cd/lm            LEDs/each optic 1            Light colour White            Required components:            C13723_MIRELLA-RZL</p>		
<p><b>CREE</b> → <b>LED</b></p> <p>LED XHP50            FWHM / FWTM 14.0° / 27.0°            Efficiency 88 %            Peak intensity 7 cd/lm            LEDs/each optic 1            Light colour White            Required components:            C13333_MIRELLA-CL</p>		

#### PHOTOMETRIC DATA (MEASURED):

##### CREE LED

LED XM-L  
 FWHM / FWTM 12.0° / 26.0°  
 Efficiency 86 %  
 Peak intensity 8.7 cd/lm  
 LEDs/each optic 1  
 Light colour White  
 Required components:  
 C12479\_MIRELLA-DL



##### CREE LED

LED XM-L  
 FWHM / FWTM 8.7° / 18.0°  
 Efficiency 90 %  
 Peak intensity 19.3 cd/lm  
 LEDs/each optic 1  
 Light colour White  
 Required components:

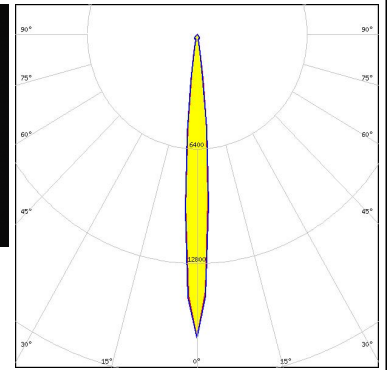

##### CREE LED

LED XM-L  
 FWHM / FWTM 12.0° / 24.0°  
 Efficiency 85 %  
 Peak intensity 11.4 cd/lm  
 LEDs/each optic 1  
 Light colour White  
 Required components:  
 C13333\_MIRELLA-CL



##### CREE LED

LED XM-L RGB  
 FWHM / FWTM 21.0° / 58.0°  
 Efficiency 84 %  
 Peak intensity 3.4 cd/lm  
 LEDs/each optic 1  
 Light colour White  
 Required components:  
 C13723\_MIRELLA-RZL

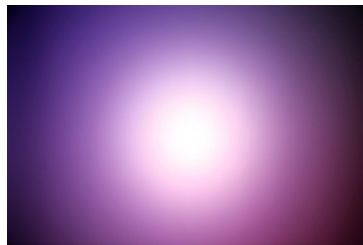

#### PHOTOMETRIC DATA (MEASURED):

##### CREE → LED

LED XM-L2  
FWHM / FWTM 12.0° / 26.0°  
Efficiency 86 %  
Peak intensity 8.2 cd/lm  
LEDs/each optic 1  
Light colour White  
Required components:  
C12479\_MIRELLA-DL



##### CREE → LED

LED XM-L2  
FWHM / FWTM 8.6° / 18.0°  
Efficiency 91 %  
Peak intensity 18.9 cd/lm  
LEDs/each optic 1  
Light colour White  
Required components:



##### CREE → LED

LED XP-G  
FWHM / FWTM 11.0° / 24.0°  
Efficiency 86 %  
Peak intensity 10.4 cd/lm  
LEDs/each optic 1  
Light colour White  
Required components:  
C12479\_MIRELLA-DL



##### CREE → LED

LED XP-G  
FWHM / FWTM 8.1° / 16.0°  
Efficiency 91 %  
Peak intensity 25 cd/lm  
LEDs/each optic 1  
Light colour White  
Required components:



#### PHOTOMETRIC DATA (MEASURED):

##### CREE LED

LED XP-G  
 FWHM / FWTM 11.0° / 22.0°  
 Efficiency 86 %  
 Peak intensity 14.1 cd/lm  
 LEDs/each optic 1  
 Light colour White  
 Required components:  
 C13333\_MIRELLA-CL



##### CREE LED

LED XP-G2  
 FWHM / FWTM 11.0° / 24.0°  
 Efficiency 87 %  
 Peak intensity 10.4 cd/lm  
 LEDs/each optic 1  
 Light colour White  
 Required components:  
 C12479\_MIRELLA-DL



##### CREE LED

LED XP-G2  
 FWHM / FWTM 7.9° / 16.0°  
 Efficiency 91 %  
 Peak intensity 25.1 cd/lm  
 LEDs/each optic 1  
 Light colour White  
 Required components:



##### CREE LED

LED XP-L HI  
 FWHM / FWTM 7.7° / 16.0°  
 Efficiency 90 %  
 Peak intensity 24.9 cd/lm  
 LEDs/each optic 1  
 Light colour White  
 Required components:

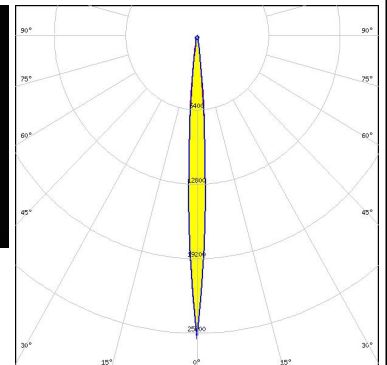
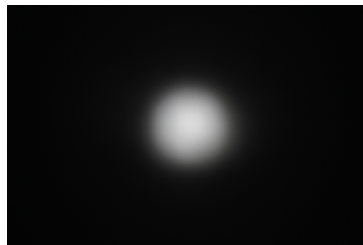

#### PHOTOMETRIC DATA (MEASURED):

##### CREE LED

LED XT-E  
 FWHM / FWTM 11.0° / 24.0°  
 Efficiency 85 %  
 Peak intensity 9.9 cd/lm  
 LEDs/each optic 1  
 Light colour White  
 Required components:  
 C12479\_MIRELLA-DL



##### CREE LED

LED XT-E  
 FWHM / FWTM 7.6° / 16.0°  
 Efficiency 89 %  
 Peak intensity 24 cd/lm  
 LEDs/each optic 1  
 Light colour White  
 Required components:



##### CREE LED

LED XT-E  
 FWHM / FWTM 10.0° / 22.0°  
 Efficiency 84 %  
 Peak intensity 14.1 cd/lm  
 LEDs/each optic 1  
 Light colour White  
 Required components:  
 C13333\_MIRELLA-CL



##### LUMILEDS

LED LUXEON 5050 Round LES  
 FWHM / FWTM 11.0° / 21.0°  
 Efficiency 93 %  
 Peak intensity 11.9 cd/lm  
 LEDs/each optic 1  
 Light colour White  
 Required components:

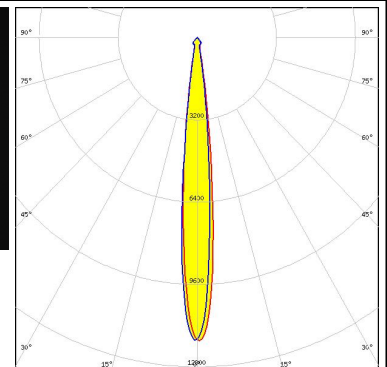
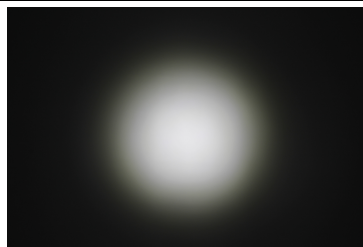



#### PHOTOMETRIC DATA (MEASURED):

##### LUMILEDS

LED LUXEON A  
 FWHM / FWTM 12.0° / 28.0°  
 Efficiency 85 %  
 Peak intensity 8.9 cd/lm  
 LEDs/each optic 1  
 Light colour White  
 Required components:  
 C12479\_MIRELLA-DL



##### LUMILEDS

LED LUXEON A  
 FWHM / FWTM 8.9° / 18.0°  
 Efficiency 89 %  
 Peak intensity 20.5 cd/lm  
 LEDs/each optic 1  
 Light colour White  
 Required components:



##### LUMILEDS

LED LUXEON A  
 FWHM / FWTM 10.0° / 22.0°  
 Efficiency 85 %  
 Peak intensity 14.5 cd/lm  
 LEDs/each optic 1  
 Light colour White  
 Required components:  
 C13333\_MIRELLA-CL



##### LUMILEDS

LED LUXEON C  
 FWHM / FWTM 22.0° / 51.0°  
 Efficiency 81 %  
 Peak intensity 3.1 cd/lm  
 LEDs/each optic 4  
 Light colour RGBW  
 Required components:  
 C13723\_MIRELLA-RZL

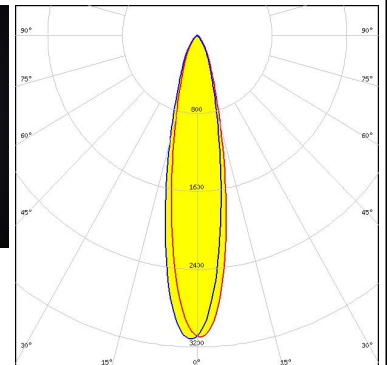
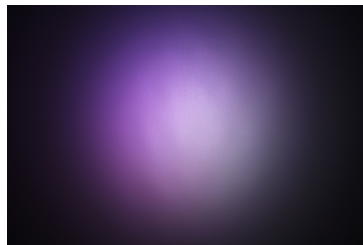

#### PHOTOMETRIC DATA (MEASURED):

#### LUMILEDS

LED LUXEON M/MX  
 FWHM / FWTM 15.0° / 34.0°  
 Efficiency 86 %  
 Peak intensity 5.9 cd/lm  
 LEDs/each optic 1  
 Light colour White  
 Required components:  
 C12479\_MIRELLA-DL



#### LUMILEDS

LED LUXEON M/MX  
 FWHM / FWTM 12.0° / 26.0°  
 Efficiency 91 %  
 Peak intensity 10.3 cd/lm  
 LEDs/each optic 1  
 Light colour White  
 Required components:

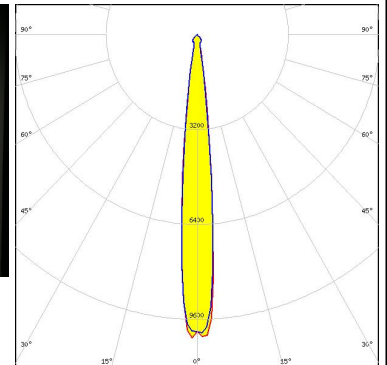

#### LUMILEDS

LED LUXEON M/MX  
 FWHM / FWTM 15.0° / 30.0°  
 Efficiency 85 %  
 Peak intensity 7.2 cd/lm  
 LEDs/each optic 1  
 Light colour White  
 Required components:  
 C13333\_MIRELLA-CL



#### LUMILEDS

LED LUXEON MZ  
 FWHM / FWTM 11.0° / 26.0°  
 Efficiency 85 %  
 Peak intensity 9.3 cd/lm  
 LEDs/each optic 1  
 Light colour White  
 Required components:  
 C12479\_MIRELLA-DL



#### PHOTOMETRIC DATA (MEASURED):

##### LUMILEDS

LED LUXEON MZ  
 FWHM / FWTM 8.7° / 18.0°  
 Efficiency 90 %  
 Peak intensity 19.3 cd/lm  
 LEDs/each optic 1  
 Light colour White  
 Required components:

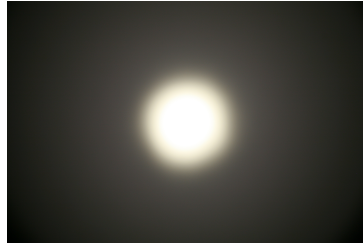

##### LUMILEDS

LED LUXEON Z  
 FWHM / FWTM 18.0° / 51.0°  
 Efficiency 82 %  
 Peak intensity 3.4 cd/lm  
 LEDs/each optic 4  
 Light colour RGBW  
 Required components:  
 C13723\_MIRELLA-RZL

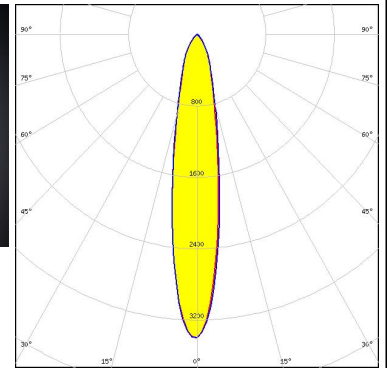
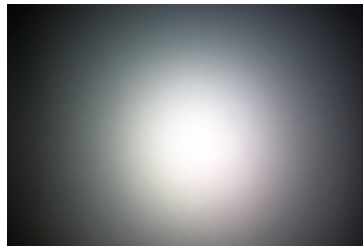

##### NICHIA

LED NS9x383  
 FWHM / FWTM 12.0° / 28.0°  
 Efficiency 85 %  
 Peak intensity 8.4 cd/lm  
 LEDs/each optic 1  
 Light colour White  
 Required components:  
 C12479\_MIRELLA-DL







##### NICHIA

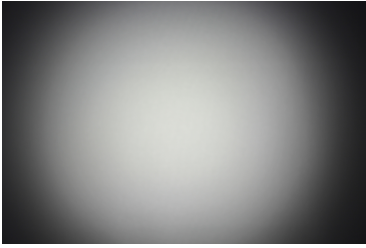
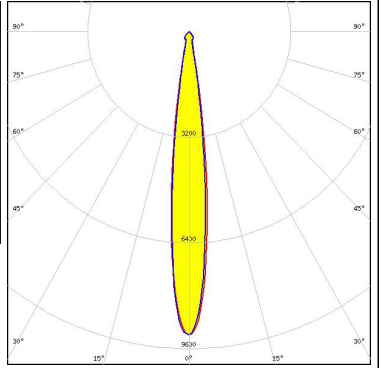

LED NS9x383  
 FWHM / FWTM 9.2° / 15.0°  
 Efficiency 89 %  
 Peak intensity 17.7 cd/lm  
 LEDs/each optic 1  
 Light colour White  
 Required components:



#### PHOTOMETRIC DATA (MEASURED):

<p><b>NICHIA</b></p> <p>LED NV4x144A            FWHM / FWTM 13.0° / 24.0°            Efficiency 92 %            Peak intensity 9.2 cd/lm            LEDs/each optic 1            Light colour White            Required components:</p>		
<p><b>OSRAM</b> Opto Semiconductors</p> <p>LED Duris S8            FWHM / FWTM 12.0° / 28.0°            Efficiency 86 %            Peak intensity 8.3 cd/lm            LEDs/each optic 1            Light colour White            Required components:            C12479_MIRELLA-DL</p>		
<p><b>OSRAM</b> Opto Semiconductors</p> <p>LED Duris S8            FWHM / FWTM 9.7° / 20.0°            Efficiency 91 %            Peak intensity 16 cd/lm            LEDs/each optic 1            Light colour White            Required components:</p>		
<p><b>OSRAM</b> Opto Semiconductors</p> <p>LED Duris S8            FWHM / FWTM 11.0° / 22.0°            Efficiency 86 %            Peak intensity 11.6 cd/lm            LEDs/each optic 1            Light colour White            Required components:            C13333_MIRELLA-CL</p>		

#### PHOTOMETRIC DATA (MEASURED):

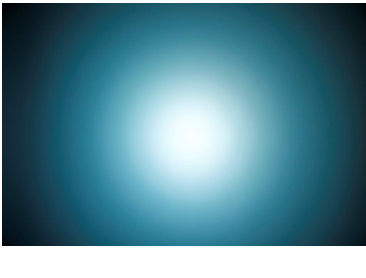
<p><b>OSRAM</b> Opto Semiconductors</p> <p>LED OSLON Square EC</p> <p>FWHM / FWTM 11.0° / 26.0°</p> <p>Efficiency 85 %</p> <p>Peak intensity 9.7 cd/lm</p> <p>LEDs/each optic 1</p> <p>Light colour White</p> <p>Required components: C12479_MIRELLA-DL</p>	
<p><b>OSRAM</b> Opto Semiconductors</p> <p>LED OSLON Square EC</p> <p>FWHM / FWTM 8.0° / 16.0°</p> <p>Efficiency 90 %</p> <p>Peak intensity 23.6 cd/lm</p> <p>LEDs/each optic 1</p> <p>Light colour White</p> <p>Required components:</p>	
<p><b>OSRAM</b> Opto Semiconductors</p> <p>LED OSLON Square EC</p> <p>FWHM / FWTM 9.4° / 20.0°</p> <p>Efficiency 85 %</p> <p>Peak intensity 15.4 cd/lm</p> <p>LEDs/each optic 1</p> <p>Light colour White</p> <p>Required components: C13333_MIRELLA-CL</p>	
<p><b>OSRAM</b> Opto Semiconductors</p> <p>LED Ostar-SMT RGB</p> <p>FWHM / FWTM 19.0° / 56.0°</p> <p>Efficiency 85 %</p> <p>Peak intensity 3.7 cd/lm</p> <p>LEDs/each optic 1</p> <p>Light colour White</p> <p>Required components: C13723_MIRELLA-RZL</p>	

#### PHOTOMETRIC DATA (MEASURED):

### SAMSUNG

LED LH508A  
 FWHM / FWTM 12.0° / 22.0°  
 Efficiency 90 %  
 Peak intensity 10.5 cd/lm  
 LEDs/each optic 1  
 Light colour White  
 Required components:

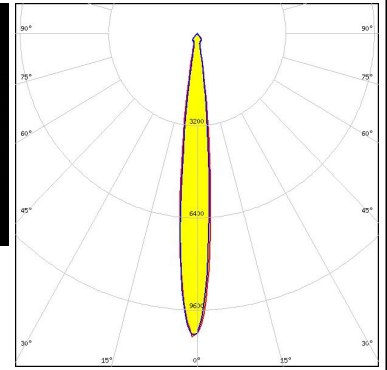

SEOUL SEMICONDUCTOR

LED F50360 (RGB)  
 FWHM / FWTM 21.0° / 55.0°  
 Efficiency 84 %  
 Peak intensity 3.3 cd/lm  
 LEDs/each optic 1  
 Light colour White  
 Required components:  
 C13723\_MIRELLA-RZL

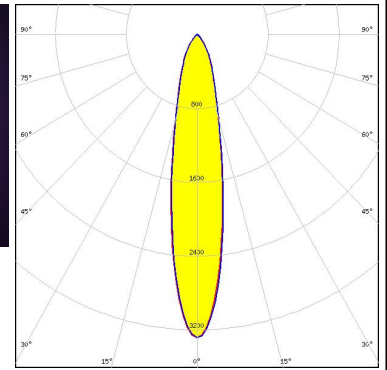

SEOUL SEMICONDUCTOR

LED F50360 (RGB)  
 FWHM / FWTM 19.0° / 56.0°  
 Efficiency 86 %  
 Peak intensity 3.8 cd/lm  
 LEDs/each optic 1  
 Light colour White  
 Required components:  
 C13723\_MIRELLA-RZL

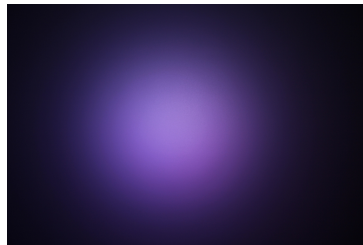

### PHOTOMETRIC DATA (SIMULATED):



LED XHP35 HD  
 FWHM / FWTM 11.0° / 20.0°  
 Efficiency 92 %  
 Peak intensity 11.8 cd/lm  
 LEDs/each optic 1  
 Light colour White  
 Required components:

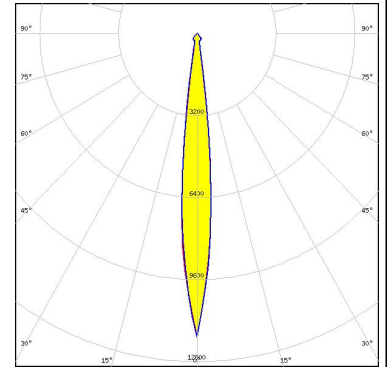

LED LUXEON 5258  
 FWHM / FWTM 9.0° / 19.0°  
 Efficiency 91 %  
 Peak intensity 17 cd/lm  
 LEDs/each optic 1  
 Light colour White  
 Required components:

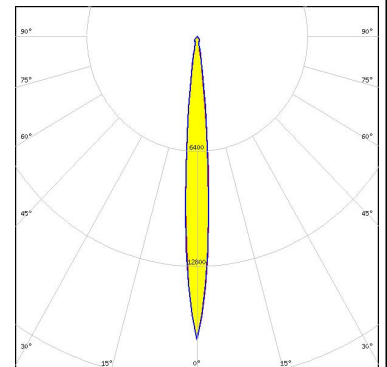

OSRAM Opto Semiconductors  
 LED OSCONIQ P 7070  
 FWHM / FWTM 11.0° / 22.0°  
 Efficiency 87 %  
 Peak intensity 10.4 cd/lm  
 LEDs/each optic 1  
 Light colour White  
 Required components:  
 C13333\_MIRELLA-CL

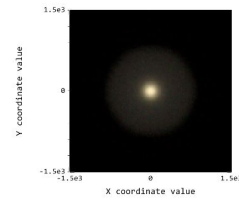

Detector Image: Illuminance  
 OSRAM\_MIRELLA-50-S-PIN\_BUS2\_FOR-IM-Configuration 1 of 1

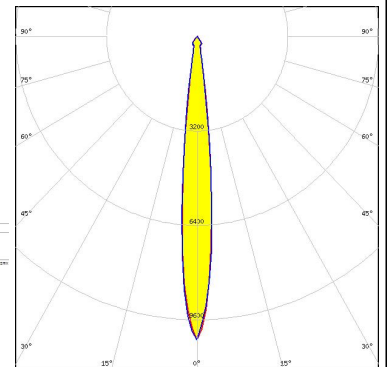

OSRAM Opto Semiconductors  
 LED OSCONIQ P 7070  
 FWHM / FWTM 10.0° / 21.0°  
 Efficiency 92 %  
 Peak intensity 11.6 cd/lm  
 LEDs/each optic 1  
 Light colour White  
 Required components:

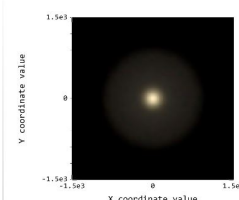

Detector Image: Illuminance  
 OSRAM\_MIRELLA-50-S-PIN\_BUS2\_FOR-IM-Configuration 1 of 1

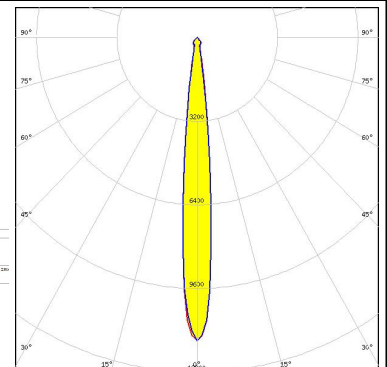

#### PHOTOMETRIC DATA (SIMULATED):





### GENERAL INFORMATION:

NOTE: The typical beam angle will be changed by different color, chip size and chip position tolerance. The typical total beam angle is the full angle measured where the luminous intensity is half of the peak value.

### MATERIALS:

As part of our continuous research and improvement processes, and to ensure the best possible quality and availability of our products, LEDiL reserves the right to change material grades without notice.

### PRODUCT DATA USER AGREEMENT AND DISCLAIMER:

The measured data in the provided downloadable LEDiL Product Datasheets and Mechanical 2D-Drawings is rounded and provided as reference for planning. LEDiL Oy's optical specifications have been verified by conducting performance testing of the products in accordance with the company's quality system. The reported data are averaged results of multiple measurements with typical variation. LEDiL Oy reserves the right to without prior notification make changes and improvements to its products.

LEDiL Oy assumes neither warranty, nor guarantee nor any other liability of any kind for the contents and correctness of the provided data. The provided data has been generated with highest diligence but the provided data may in reality not represent the complete possible variation range of all intrinsic parameters. Therefore, in certain cases a deviation from the provided data could occur.

LEDiL Oy reserves the right to undertake technical changes of its products without further notification which could lead to changes in the provided data. LEDiL Oy assumes no liability of any kind for the possible deviation from any provided data or any other damage resulting from the usage of the provided data.

The user agrees to this disclaimer and user agreement with the download or usage of the provided files.

#### LEDiL Oy

Joensuunkatu 13  
FI-24240 SALO  
Finland

#### LEDiL Inc.

228 West Page Street  
Suite D  
Sycamore IL 60178  
USA

#### Ledil Optics Technology (Shenzhen) Co., Ltd.

# 405 , Block B  
Casic Motor Building  
Shenzhen 518057  
P.R.CHINA

#### Local sales and technical support

[www.ledil.com/  
where\\_to\\_buy](http://www.ledil.com/where_to_buy)

#### Shipping locations

Salo, Finland  
Hong Kong, China

#### Distribution Partners

[www.ledil.com/  
where\\_to\\_buy](http://www.ledil.com/where_to_buy)

## X-ON Electronics

Largest Supplier of Electrical and Electronic Components

*Click to view similar products for [LED Lighting Reflectors](#) category:*

*Click to view products by [Ledil](#) manufacturer:*

Other Similar products are found below :

[LL04CR-CFN35155L02](#) [LL04CR-CFN60155L02](#) [LL04CR-CGM85135L02](#) [F13185\\_GERI-RZ](#) [10604](#) [LL01SP-ATH15R49](#) [10170](#) [12527](#)  
[12531](#) [12568](#) [C13253\\_TINA2-R-CLIP16](#) [CA14591\\_BROOKE-XW](#) [F15560\\_MIRELLA-G2-W](#) [CA11525\\_LAURA-R-W](#) [12796](#) [LMH020-](#)  
[REFL-0000-0000062](#) [LMH020-REFL-0000-0000082](#) [C12606\\_LENINA-DL](#) [CN12711\\_LENINA-W-DL](#) [C11394\\_TYRA-S](#) [C11396\\_TYRA-](#)  
[W](#) [C11508\\_BROOKE-W](#) [C11552\\_BARBARA-S](#) [C11553\\_BARBARA-W](#) [C11862\\_MINNIE-W](#) [C11979\\_LENA-S](#) [C11980\\_LENA-W](#)  
[C11996\\_LENA-LENS](#) [C12083\\_BROOKE-SCR-M](#) [C12095\\_MINNIE-M](#) [C12097\\_MINNIE-WWW](#) [C12154\\_LENA-M](#) [C12469\\_LISA2-R-](#)  
[PIN](#) [C12476\\_MIRELLA-50-S](#) [C12477\\_MIRELLA-50-M](#) [C12480\\_MIRELLA-50-S-PIN](#) [C12516\\_RITA-WAS](#) [C12597\\_LENINA-S](#)  
[C12599\\_LENINA-W](#) [C12948\\_LENA-WAS](#) [C12958\\_LENINA-XW](#) [C13085\\_MIRELLA-50-S-PF](#) [C13087\\_MIRELLA-50-W-PF](#)  
[C13101\\_LENA-X-WAS](#) [C13555\\_BRIDGET-W-UNI](#) [C13556\\_BRIDGET-M-UNI](#) [C13557\\_BRIDGET-S-UNI](#) [C14346\\_ANGELETTE-WAS](#)  
[C17099\\_ALISE-50-DL](#) [C17095\\_ALISE-70-CL](#)