

MIRELLA-50-M-PIN

~30° medium beam

TECHNICAL SPECIFICATIONS:

Dimensions	Ø 49.9 mm
Height	23.9 mm
Fastening	pin
ROHS compliant	yes ⓘ

MATERIAL SPECIFICATIONS:

Component	Type	Material	Colour	Finish	Coating
MIRELLA-50-M-PIN	Reflector	PC	metal		lacquer



ORDERING INFORMATION:

Component	Qty in box	MOQ	MPQ	Box weight (kg)
C12481_MIRELLA-50-M-PIN » Box size: 480 x 280 x 300 mm	336	112	28	3.1

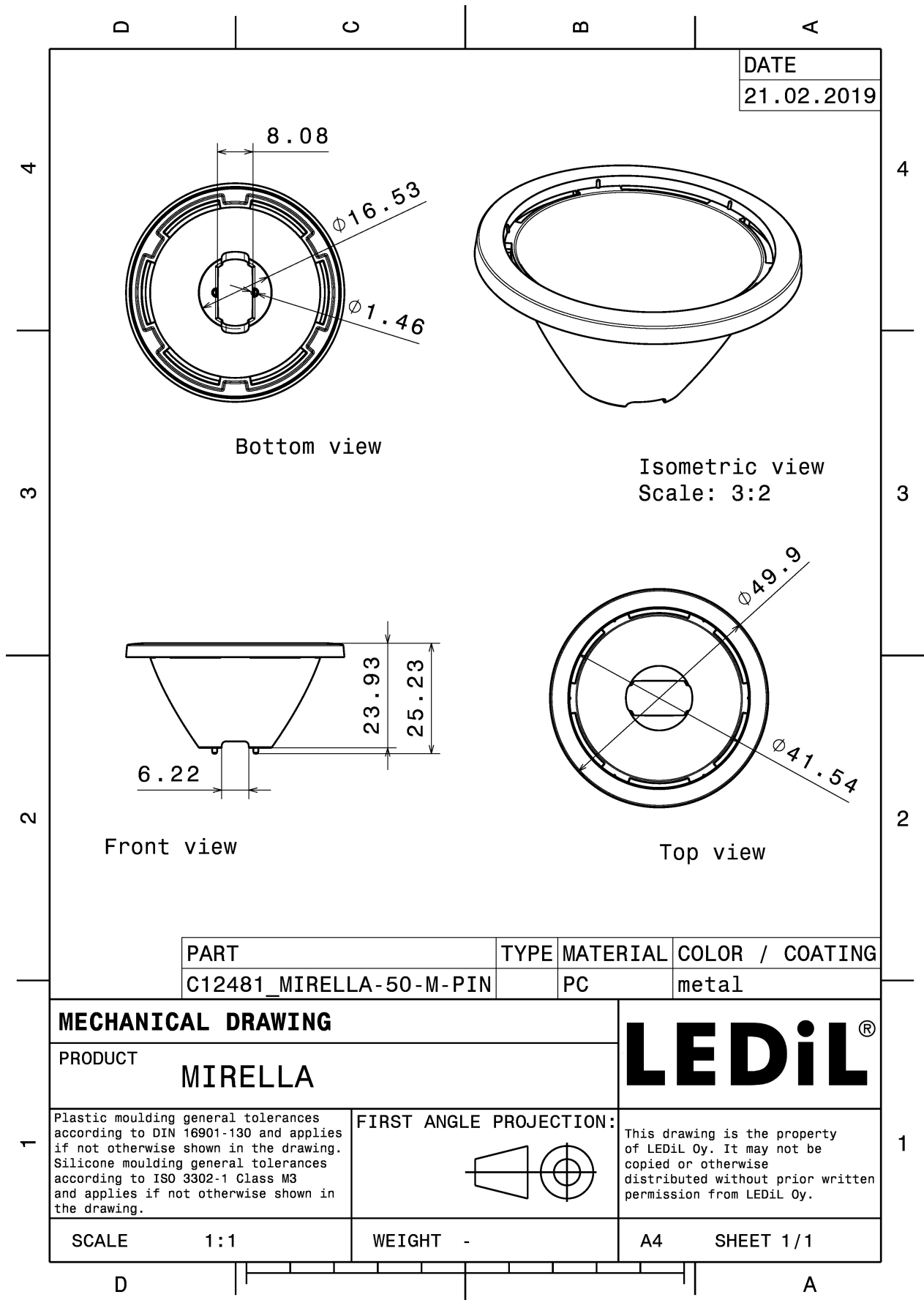

PART	TYPE	MATERIAL	COLOR / COATING
C12481_MIRELLA-50-M-PIN		PC	metal

MECHANICAL DRAWING

PRODUCT
MIRELLA

LEDiL®

Plastic moulding general tolerances according to DIN 16901-130 and applies if not otherwise shown in the drawing. Silicone moulding general tolerances according to ISO 3302-1 Class M3 and applies if not otherwise shown in the drawing.

FIRST ANGLE PROJECTION:

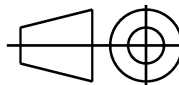







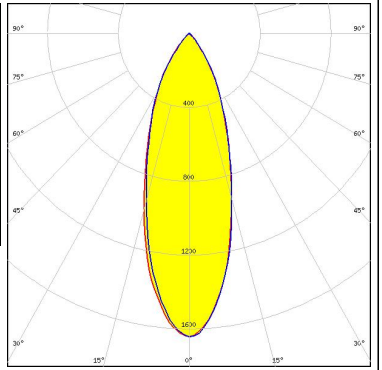

This drawing is the property of LEDiL Oy. It may not be copied or otherwise distributed without prior written permission from LEDiL Oy.

SCALE	1:1	WEIGHT	-	A4	SHEET 1/1
-------	-----	--------	---	----	-----------

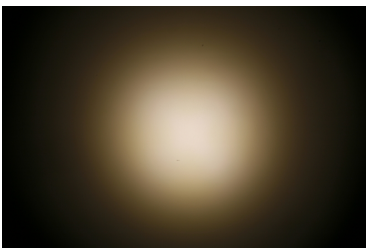
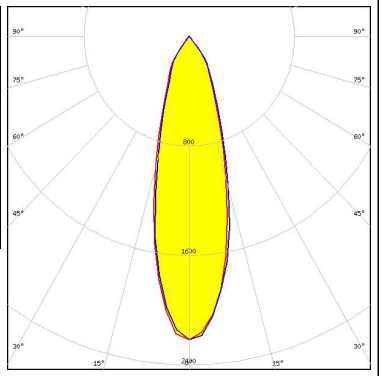
See also our general installation guide: www.ledil.com/installation_guide

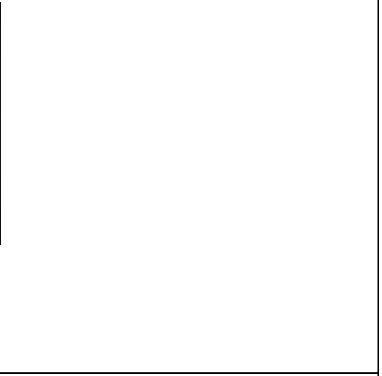
PHOTOMETRIC DATA (MEASURED):

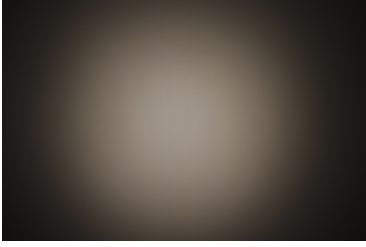
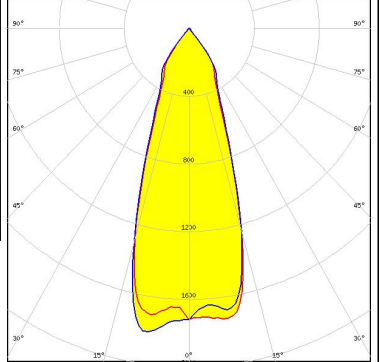
<p></p> <p>LED SM4 FWHM / FWTM 35.0° / 73.0° Efficiency 78 % Peak intensity 1.7 cd/lm LEDs/each optic 1 Light colour White Required components: C12479_MIRELLA-DL</p>		
<p></p> <p>LED SM4 FWHM / FWTM 29.0° / 68.0° Efficiency 80 % Peak intensity 2.2 cd/lm LEDs/each optic 1 Light colour White Required components: C13333_MIRELLA-CL</p>		
<p></p> <p>LED MHB-A/B FWHM / FWTM 34.0° / 78.0° Efficiency 83 % Peak intensity 2 cd/lm LEDs/each optic 1 Light colour White Required components: C13333_MIRELLA-CL</p>		
<p></p> <p>LED MHB-A/B FWHM / FWTM 35.0° / 76.0° Efficiency 83 % Peak intensity 1.8 cd/lm LEDs/each optic 1 Light colour White Required components: C12479_MIRELLA-DL</p>		

PHOTOMETRIC DATA (MEASURED):

CREE LED

LED MHB-A/B
 FWHM / FWTM 28.0° / 80.0°
 Efficiency 88 %
 Peak intensity 2.5 cd/m
 LEDs/each optic 1
 Light colour White
 Required components:



CREE LED

LED XHP50
 FWHM / FWTM 32.0° / 76.0°
 Efficiency 85 %
 Peak intensity 1.9 cd/m
 LEDs/each optic 1
 Light colour White
 Required components:
 C13333_MIRELLA-CL

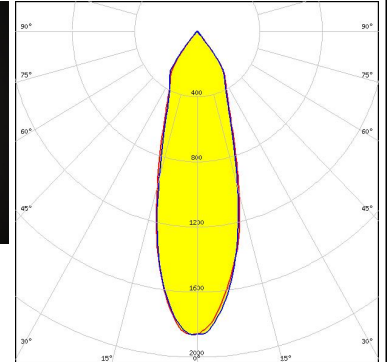

CREE LED

LED XHP50
 FWHM / FWTM 32.0° / 74.0°
 Efficiency 86 %
 Peak intensity 1.8 cd/m
 LEDs/each optic 1
 Light colour White
 Required components:
 C12479_MIRELLA-DL

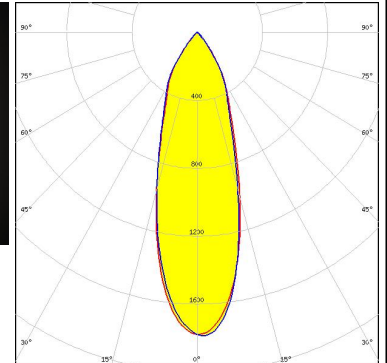
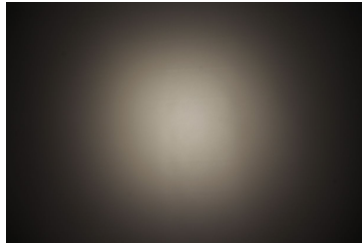

CREE LED

LED XHP50
 FWHM / FWTM 37.0° / 78.0°
 Efficiency 83 %
 Peak intensity 1.4 cd/m
 LEDs/each optic 1
 Light colour White
 Required components:
 C13723_MIRELLA-RZL

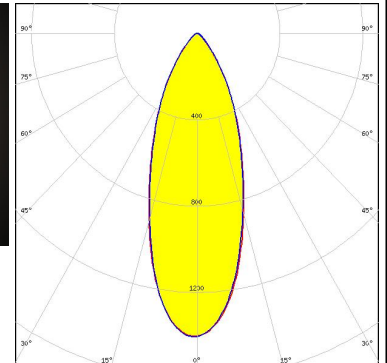
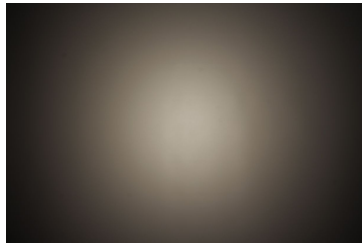

PHOTOMETRIC DATA (MEASURED):

CREE LED

LED XHP50
 FWHM / FWTM 25.0° / 77.0°
 Efficiency 90 %
 Peak intensity 2.5 cd/m
 LEDs/each optic 1
 Light colour White
 Required components:

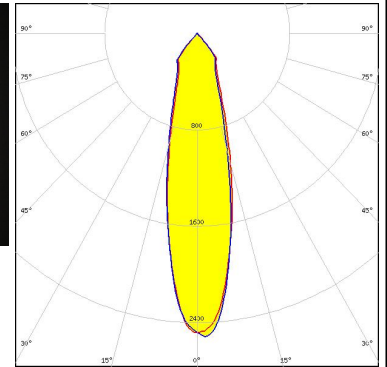
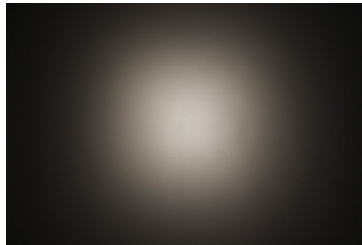

CREE LED

LED XM-L
 FWHM / FWTM 35.0° / 76.0°
 Efficiency 80 %
 Peak intensity 1.5 cd/m
 LEDs/each optic 1
 Light colour White
 Required components:
 C12479_MIRELLA-DL

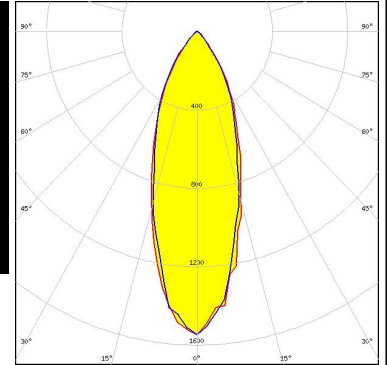

CREE LED

LED XM-L
 FWHM / FWTM 24.0° / 56.0°
 Efficiency 89 %
 Peak intensity 2.9 cd/m
 LEDs/each optic 1
 Light colour White
 Required components:

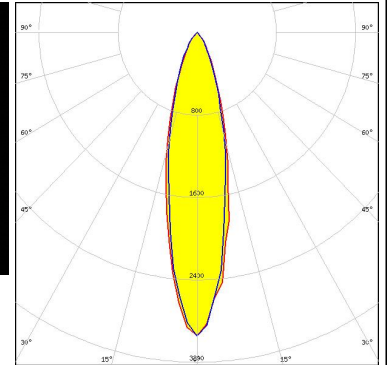



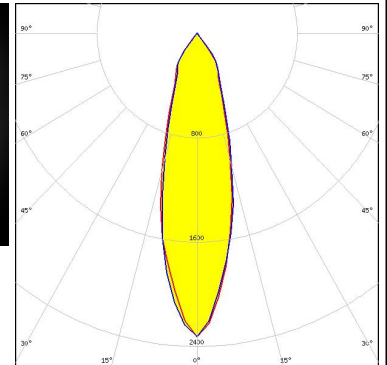

CREE LED



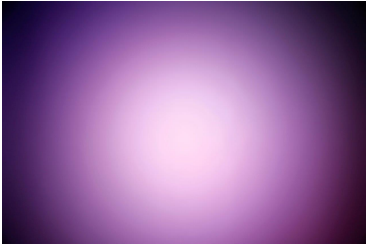
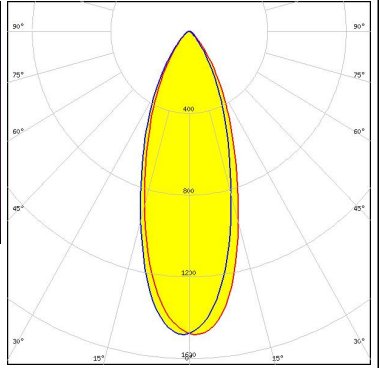

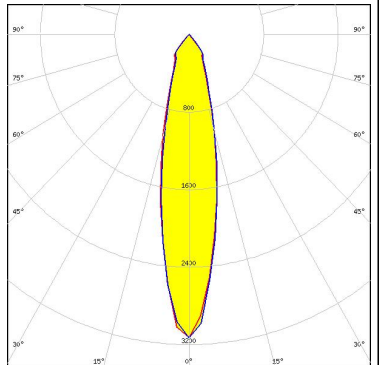

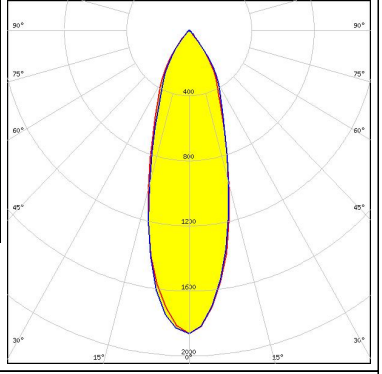
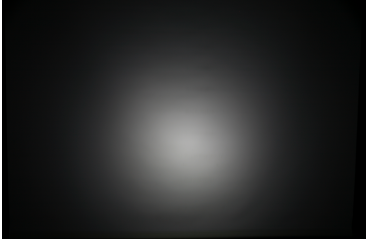
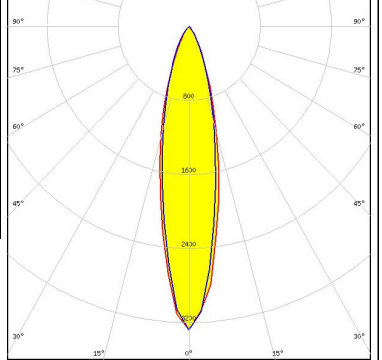

LED XM-L
 FWHM / FWTM 28.0° / 72.0°
 Efficiency 84 %
 Peak intensity 2.3 cd/m
 LEDs/each optic 1
 Light colour White
 Required components:
 C13333_MIRELLA-CL

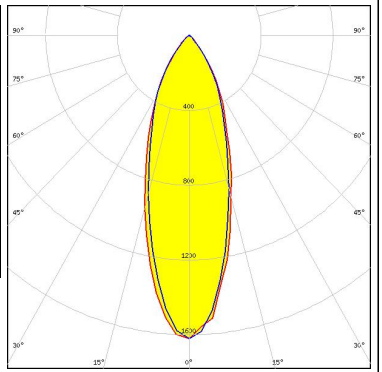

PHOTOMETRIC DATA (MEASURED):

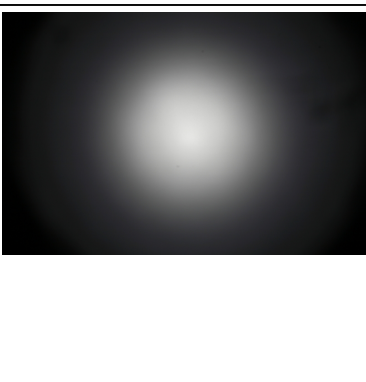
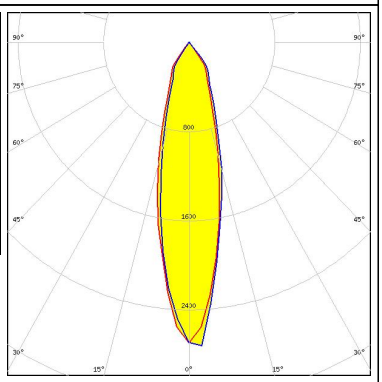
<p>CREE → LED</p> <p>LED XM-L RGB FWHM / FWTM 37.0° / 76.0° Efficiency 83 % Peak intensity 1.5 cd/m LEDs/each optic 1 Light colour White Required components: C13723_MIRELLA-RZL</p>		
<p>CREE → LED</p> <p>LED XM-L2 FWHM / FWTM 22.0° / 58.0° Efficiency 91 % Peak intensity 3.1 cd/m LEDs/each optic 1 Light colour White Required components:</p>		
<p>CREE → LED</p> <p>LED XM-L2 FWHM / FWTM 33.0° / 74.0° Efficiency 82 % Peak intensity 1.9 cd/m LEDs/each optic 1 Light colour White Required components: C12479_MIRELLA-DL</p>		
<p>CREE → LED</p> <p>LED XP-G FWHM / FWTM 24.0° / 53.0° Efficiency 86 % Peak intensity 3.3 cd/m LEDs/each optic 1 Light colour White Required components:</p>		

PHOTOMETRIC DATA (MEASURED):

<p>CREE  LED</p> <p>LED XP-G FWHM / FWTM 34.0° / 74.0° Efficiency 81 % Peak intensity 1.6 cd/lm LEDs/each optic 1 Light colour White Required components: C12479_MIRELLA-DL</p>		
<p>CREE  LED</p> <p>LED XP-G FWHM / FWTM 24.0° / 68.0° Efficiency 83 % Peak intensity 2.7 cd/lm LEDs/each optic 1 Light colour White Required components: C13333_MIRELLA-CL</p>		
<p>CREE  LED</p> <p>LED XP-G2 FWHM / FWTM 30.0° / 74.0° Efficiency 83 % Peak intensity 2 cd/lm LEDs/each optic 1 Light colour White Required components: C12479_MIRELLA-DL</p>		
<p>CREE  LED</p> <p>LED XP-G2 FWHM / FWTM 22.0° / 76.0° Efficiency 88 % Peak intensity 2.9 cd/lm LEDs/each optic 1 Light colour White Required components:</p>		

PHOTOMETRIC DATA (MEASURED):

CREE LED

LED XP-L HI
 FWHM / FWTM 17.0° / 48.0°
 Efficiency 88 %
 Peak intensity 4.5 cd/m
 LEDs/each optic 1
 Light colour White
 Required components:

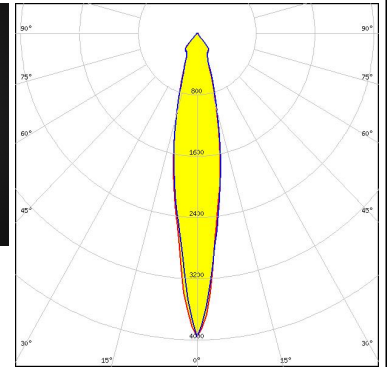

CREE LED

LED XT-E
 FWHM / FWTM 32.0° / 73.0°
 Efficiency 78 %
 Peak intensity 1.8 cd/m
 LEDs/each optic 1
 Light colour White
 Required components:
 C12479_MIRELLA-DL

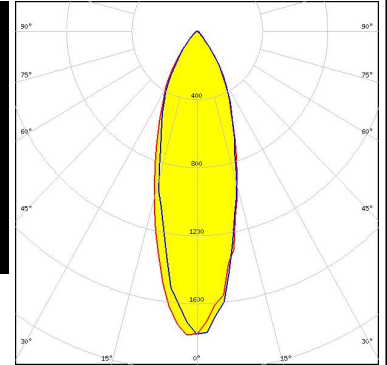

CREE LED

LED XT-E
 FWHM / FWTM 23.0° / 51.0°
 Efficiency 85 %
 Peak intensity 3.4 cd/m
 LEDs/each optic 1
 Light colour White
 Required components:

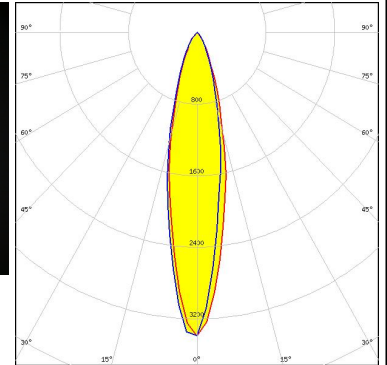



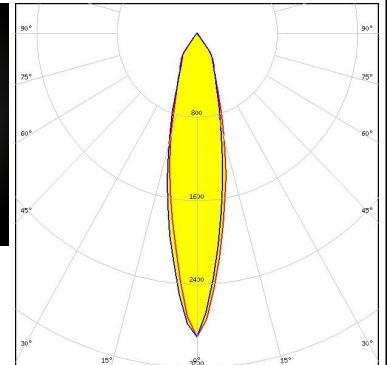
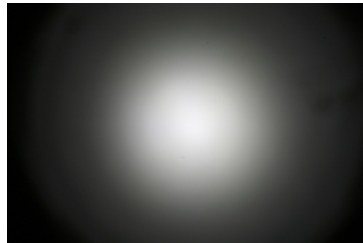

CREE LED

LED XT-E
 FWHM / FWTM 22.0° / 64.0°
 Efficiency 81 %
 Peak intensity 2.9 cd/m
 LEDs/each optic 1
 Light colour White
 Required components:
 C13333_MIRELLA-CL

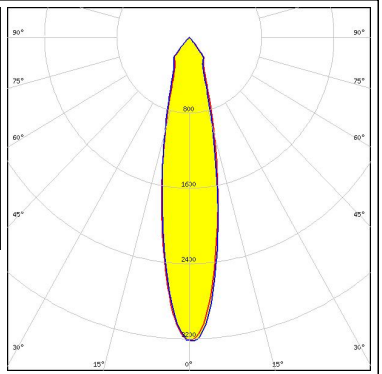

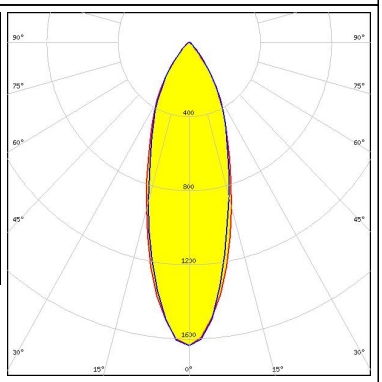
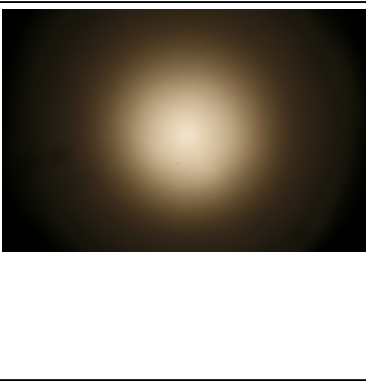
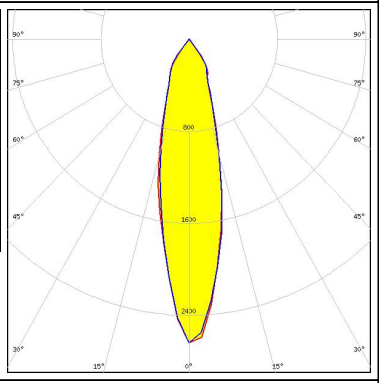
PHOTOMETRIC DATA (MEASURED):

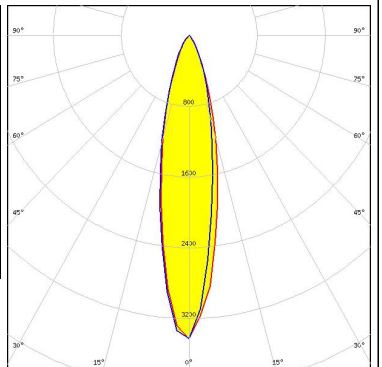
<p>LUMILEDS</p> <p>LED LUXEON 5050 Round LES</p> <p>FWHM / FWTM 22.0° / 59.0°</p> <p>Efficiency 90 %</p> <p>Peak intensity 3.2 cd/lm</p> <p>LEDs/each optic 1</p> <p>Light colour White</p> <p>Required components:</p>		
<p>LUMILEDS</p> <p>LED LUXEON A</p> <p>FWHM / FWTM 34.0° / 75.0°</p> <p>Efficiency 80 %</p> <p>Peak intensity 1.6 cd/lm</p> <p>LEDs/each optic 1</p> <p>Light colour White</p> <p>Required components: C12479_MIRELLA-DL</p>		
<p>LUMILEDS</p> <p>LED LUXEON A</p> <p>FWHM / FWTM 24.0° / 69.0°</p> <p>Efficiency 84 %</p> <p>Peak intensity 2.6 cd/lm</p> <p>LEDs/each optic 1</p> <p>Light colour White</p> <p>Required components: C13333_MIRELLA-CL</p>		
<p>LUMILEDS</p> <p>LED LUXEON A</p> <p>FWHM / FWTM 22.0° / 52.0°</p> <p>Efficiency 87 %</p> <p>Peak intensity 3.4 cd/lm</p> <p>LEDs/each optic 1</p> <p>Light colour White</p> <p>Required components:</p>		

PHOTOMETRIC DATA (MEASURED):

LUMILEDS

LED LUXEON C
 FWHM / FWTM 39.0° / 79.0°
 Efficiency 74 %
 Peak intensity 1.2 cd/lm
 LEDs/each optic 4
 Light colour RGBW
 Required components:
 C13723_MIRELLA-RZL

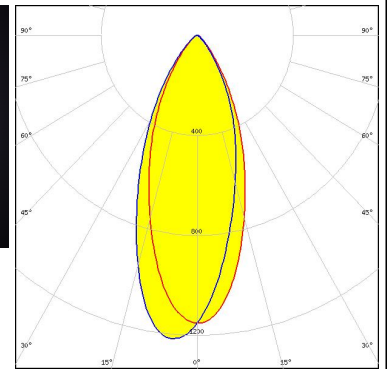
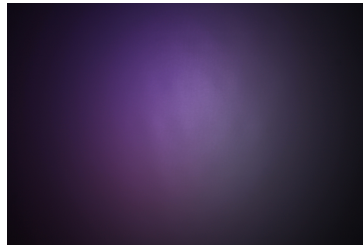

LUMILEDS

LED LUXEON M/MX
 FWHM / FWTM 38.0° / 78.0°
 Efficiency 81 %
 Peak intensity 1.5 cd/lm
 LEDs/each optic 1
 Light colour White
 Required components:
 C12479_MIRELLA-DL

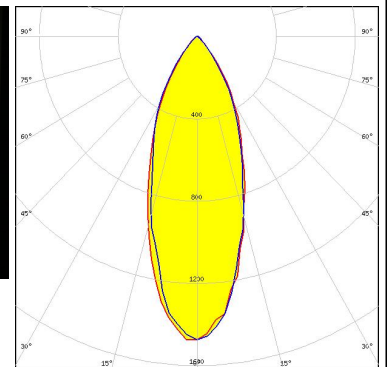

LUMILEDS

LED LUXEON M/MX
 FWHM / FWTM 24.0° / 63.0°
 Efficiency 87 %
 Peak intensity 2.6 cd/lm
 LEDs/each optic 1
 Light colour White
 Required components:

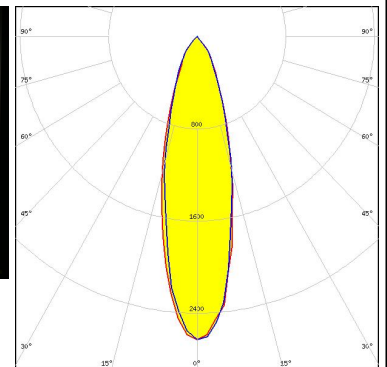

LUMILEDS

LED LUXEON M/MX
 FWHM / FWTM 33.0° / 74.0°
 Efficiency 84 %
 Peak intensity 2 cd/lm
 LEDs/each optic 1
 Light colour White
 Required components:
 C13333_MIRELLA-CL

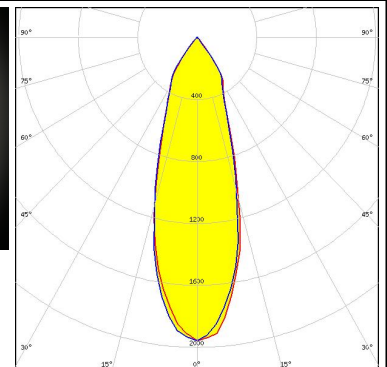
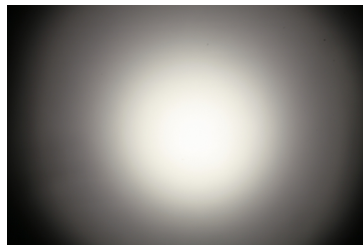

PHOTOMETRIC DATA (MEASURED):

LUMILEDS

LED LUXEON MZ
 FWHM / FWTM 27.0° / 69.0°
 Efficiency 84 %
 Peak intensity 2.4 cd/lm
 LEDs/each optic 1
 Light colour White
 Required components:
 C12479_MIRELLA-DL

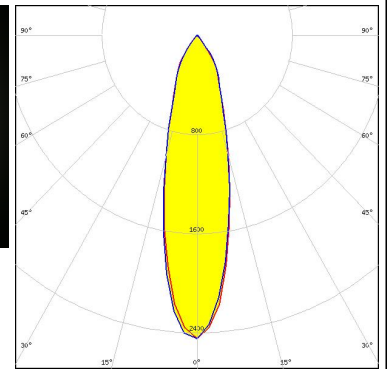
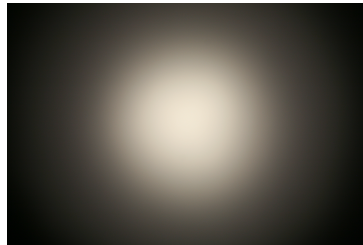

LUMILEDS

LED LUXEON MZ
 FWHM / FWTM 20.0° / 47.0°
 Efficiency 88 %
 Peak intensity 4 cd/lm
 LEDs/each optic 1
 Light colour White
 Required components:

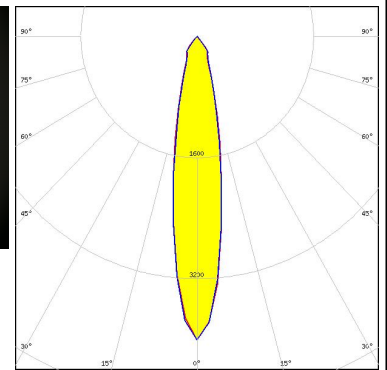

LUMILEDS

LED LUXEON Z
 FWHM / FWTM 31.0° / 71.0°
 Efficiency 83 %
 Peak intensity 1.7 cd/lm
 LEDs/each optic 4
 Light colour RGBW
 Required components:
 C13723_MIRELLA-RZL

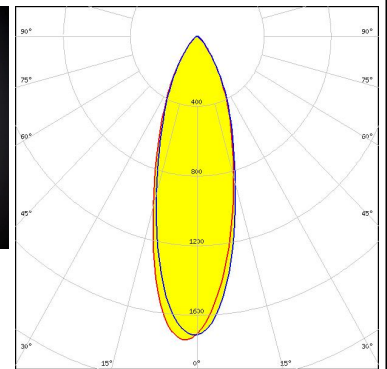
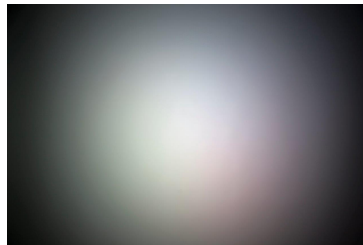

NICHIA

LED NS9x383
 FWHM / FWTM 32.0° / 74.0°
 Efficiency 83 %
 Peak intensity 1.7 cd/lm
 LEDs/each optic 1
 Light colour White
 Required components:
 C12479_MIRELLA-DL

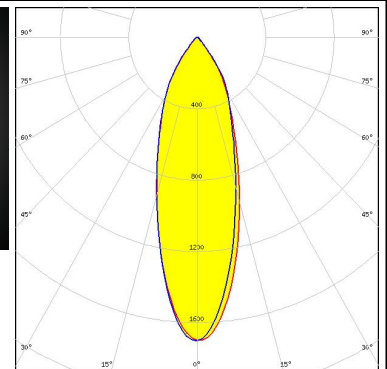
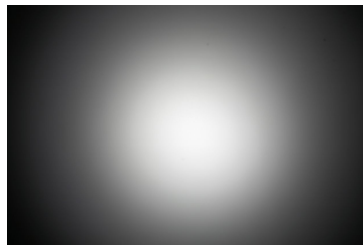

PHOTOMETRIC DATA (MEASURED):



LED NS9x383
 FWHM / FWTM 24.0° / 78.0°
 Efficiency 88 %
 Peak intensity 2.5 cd/m
 LEDs/each optic 1
 Light colour White
 Required components:

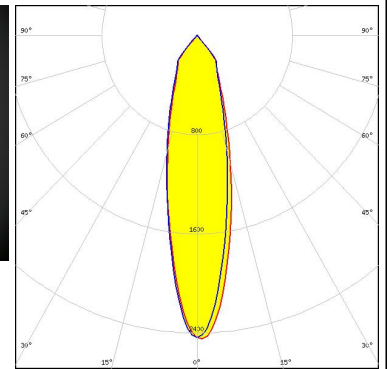

LED NV4x144A
 FWHM / FWTM 27.0° / 73.0°
 Efficiency 89 %
 Peak intensity 2.5 cd/m
 LEDs/each optic 1
 Light colour White
 Required components:

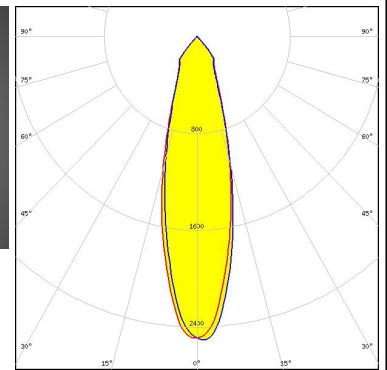
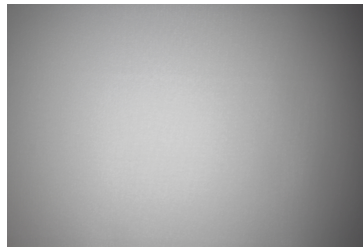



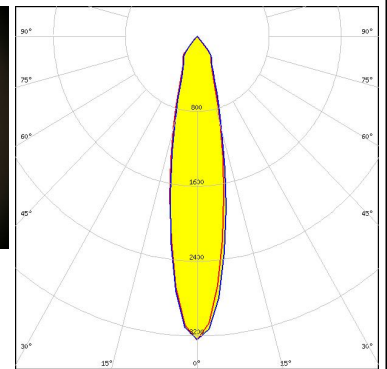

LED Duris S8
 FWHM / FWTM 22.0° / 58.0°
 Efficiency 88 %
 Peak intensity 3.2 cd/m
 LEDs/each optic 1
 Light colour White
 Required components:

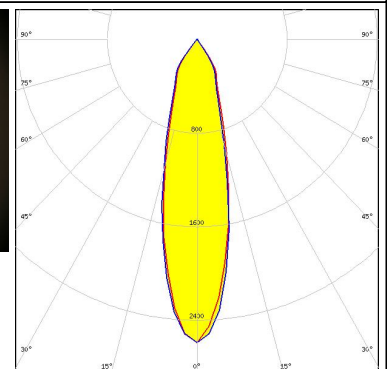

LED Duris S8
 FWHM / FWTM 26.0° / 70.0°
 Efficiency 84 %
 Peak intensity 2.6 cd/m
 LEDs/each optic 1
 Light colour White
 Required components:
 C13333_MIRELLA-CL

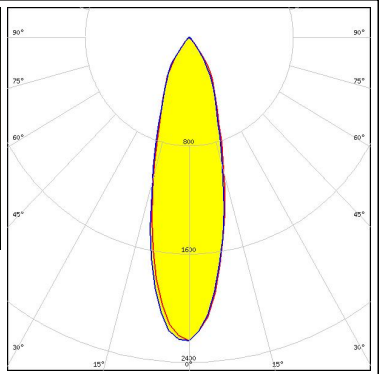

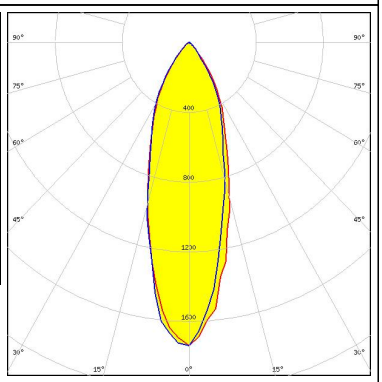
PHOTOMETRIC DATA (MEASURED):

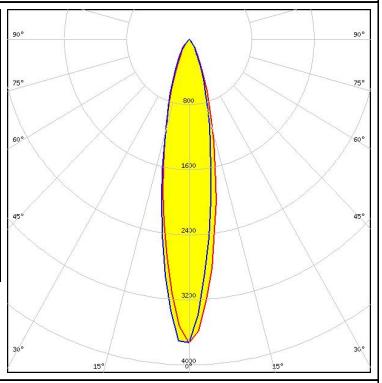
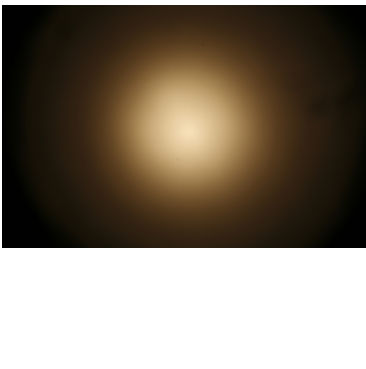
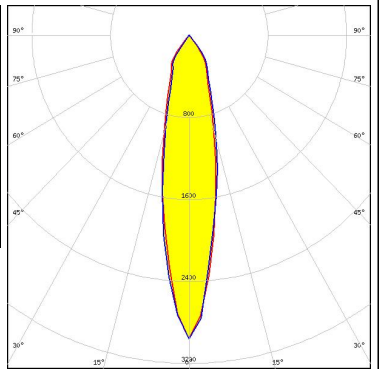
<p>OSRAM Opto Semiconductors</p> <p>LED Duris S8</p> <p>FWHM / FWTM 28.0° / 69.0°</p> <p>Efficiency 84 %</p> <p>Peak intensity 2.2 cd/lm</p> <p>LEDs/each optic 1</p> <p>Light colour White</p> <p>Required components: C12479_MIRELLA-DL</p>		
<p>OSRAM Opto Semiconductors</p> <p>LED OSLOM Square EC</p> <p>FWHM / FWTM 32.0° / 75.0°</p> <p>Efficiency 79 %</p> <p>Peak intensity 1.7 cd/lm</p> <p>LEDs/each optic 1</p> <p>Light colour White</p> <p>Required components: C12479_MIRELLA-DL</p>		
<p>OSRAM Opto Semiconductors</p> <p>LED OSLOM Square EC</p> <p>FWHM / FWTM 22.0° / 49.0°</p> <p>Efficiency 84 %</p> <p>Peak intensity 3.4 cd/lm</p> <p>LEDs/each optic 1</p> <p>Light colour White</p> <p>Required components:</p>		
<p>OSRAM Opto Semiconductors</p> <p>LED OSLOM Square EC</p> <p>FWHM / FWTM 22.0° / 67.0°</p> <p>Efficiency 83 %</p> <p>Peak intensity 3 cd/lm</p> <p>LEDs/each optic 1</p> <p>Light colour White</p> <p>Required components: C13333_MIRELLA-CL</p>		

PHOTOMETRIC DATA (MEASURED):

OSRAM

Opto Semiconductors

LED Ostar-SMT RGB
 FWHM / FWTM 34.0° / 74.0°
 Efficiency 83 %
 Peak intensity 1.6 cd/lm
 LEDs/each optic 1
 Light colour White
 Required components:
 C13723_MIRELLA-RZL

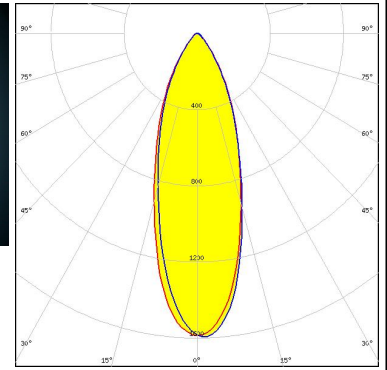
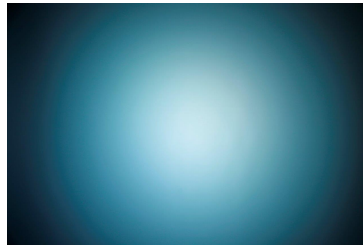

SAMSUNG

LED LH508A
 FWHM / FWTM 24.0° / 78.0°
 Efficiency 88 %
 Peak intensity 2.4 cd/lm
 LEDs/each optic 1
 Light colour White
 Required components:

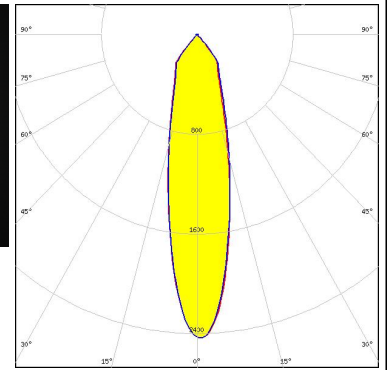
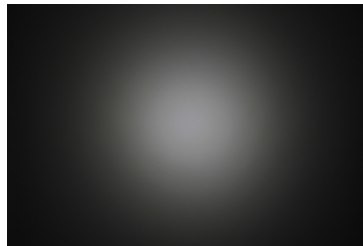

SEOUL SEMICONDUCTOR

LED F50360 (RGB)
 FWHM / FWTM 33.0° / 76.0°
 Efficiency 82 %
 Peak intensity 1.8 cd/lm
 LEDs/each optic 1
 Light colour White
 Required components:
 C13723_MIRELLA-RZL

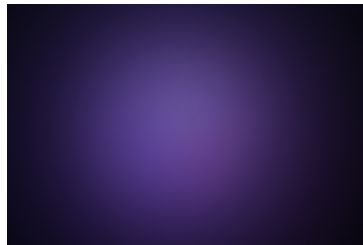

PHOTOMETRIC DATA (SIMULATED):

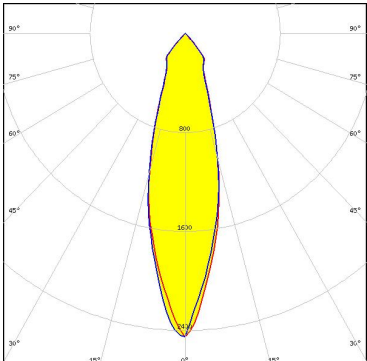
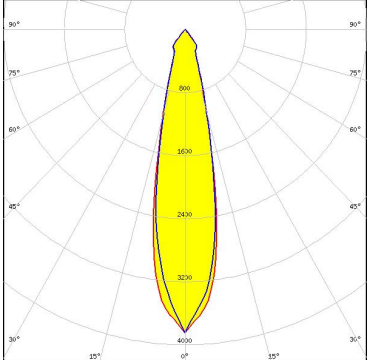
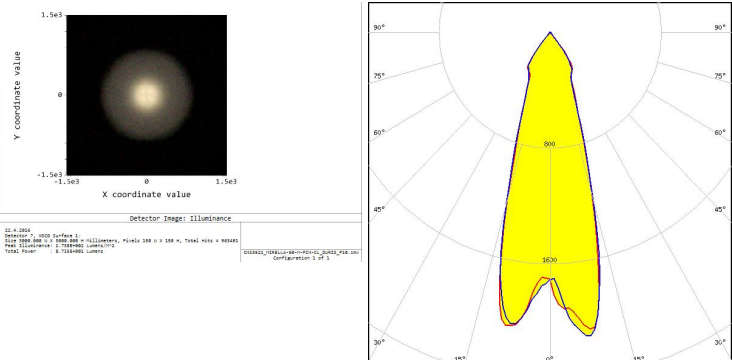
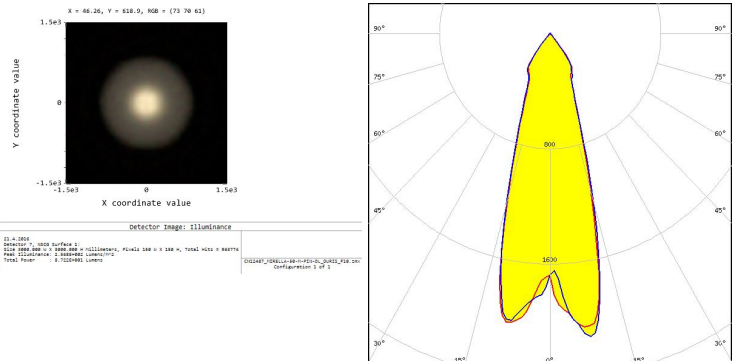
<p>CREE LED</p> <p>LED: XHP35 HD FWHM / FWTM: 28.0° / 77.0° Efficiency: 92 % Peak intensity: 2.5 cd/lm LEDs/each optic: 1 Light colour: White Required components:</p>	
<p>LUMILEDS</p> <p>LED: LUXEON 5258 FWHM / FWTM: 23.0° / 45.0° Efficiency: 91 % Peak intensity: 3.8 cd/lm LEDs/each optic: 1 Light colour: White Required components:</p>	
<p>OSRAM Opto Semiconductors</p> <p>LED: OSCONIQ P 7070 FWHM / FWTM: 29.0° / 70.0° Efficiency: 87 % Peak intensity: 2.3 cd/lm LEDs/each optic: 1 Light colour: White Required components: C13333_MIRELLA-CL</p>	
<p>OSRAM Opto Semiconductors</p> <p>LED: OSCONIQ P 7070 FWHM / FWTM: 31.0° / 72.0° Efficiency: 88 % Peak intensity: 2.4 cd/lm LEDs/each optic: 1 Light colour: White Required components: C12479_MIRELLA-DL</p>	

PHOTOMETRIC DATA (SIMULATED):

OSRAM

Opto Semiconductors

LED OSCONIQ P 7070
 FWHM / FWTM 26.0° / 63.0°
 Efficiency 91 %
 Peak intensity 2.9 cd/lm
 LEDs/each optic 1
 Light colour White
 Required components:

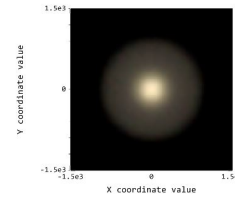

Detector Image: Illuminance

01-11-2018
 Detector: s_smc surface 1
 Size: 1000.000 x 1.000 mm x
 Peak Illuminance: 0.000000 Lux/m²
 Total flux: 0.000000 Lumens

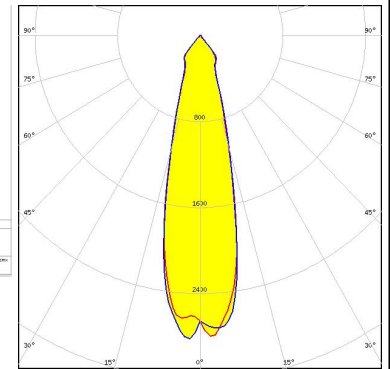

SAMSUNG

LED LH351D
 FWHM / FWTM 26.0° / 54.0°
 Efficiency 90 %
 Peak intensity 3 cd/lm
 LEDs/each optic 1
 Light colour White
 Required components:

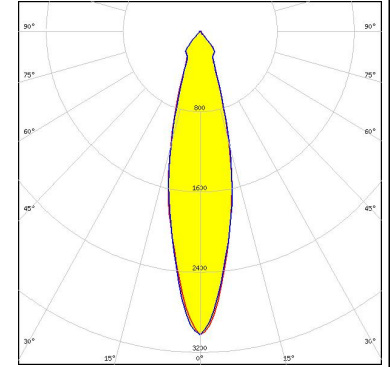

SEOUL SEMICONDUCTOR

LED Z8Y22P
 FWHM / FWTM 19.0° / 44.0°
 Efficiency 89 %
 Peak intensity 4.3 cd/lm
 LEDs/each optic 1
 Light colour White
 Required components:

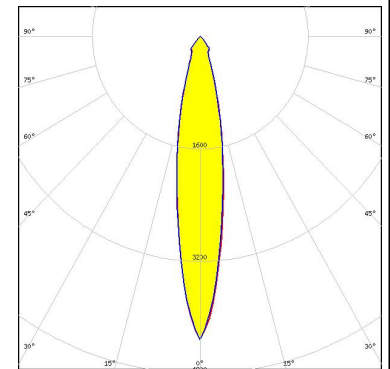

GENERAL INFORMATION:

NOTE: The typical beam angle will be changed by different color, chip size and chip position tolerance. The typical total beam angle is the full angle measured where the luminous intensity is half of the peak value.

MATERIALS:

As part of our continuous research and improvement processes, and to ensure the best possible quality and availability of our products, LEDiL reserves the right to change material grades without notice.

PRODUCT DATA USER AGREEMENT AND DISCLAIMER:

The measured data in the provided downloadable LEDiL Product Datasheets and Mechanical 2D-Drawings is rounded and provided as reference for planning. LEDiL Oy's optical specifications have been verified by conducting performance testing of the products in accordance with the company's quality system. The reported data are averaged results of multiple measurements with typical variation. LEDiL Oy reserves the right to without prior notification make changes and improvements to its products.

LEDiL Oy assumes neither warranty, nor guarantee nor any other liability of any kind for the contents and correctness of the provided data. The provided data has been generated with highest diligence but the provided data may in reality not represent the complete possible variation range of all intrinsic parameters. Therefore, in certain cases a deviation from the provided data could occur.

LEDiL Oy reserves the right to undertake technical changes of its products without further notification which could lead to changes in the provided data. LEDiL Oy assumes no liability of any kind for the possible deviation from any provided data or any other damage resulting from the usage of the provided data.

The user agrees to this disclaimer and user agreement with the download or usage of the provided files.

LEDiL Oy

Joensuunkatu 13
FI-24240 SALO
Finland

LEDiL Inc.

228 West Page Street
Suite D
Sycamore IL 60178
USA

Ledil Optics Technology (Shenzhen) Co., Ltd.

405 , Block B
Casic Motor Building
Shenzhen 518057
P.R.CHINA

Local sales and technical support

[www.ledil.com/
where_to_buy](http://www.ledil.com/where_to_buy)

Shipping locations

Salo, Finland
Hong Kong, China

Distribution Partners

[www.ledil.com/
where_to_buy](http://www.ledil.com/where_to_buy)

X-ON Electronics

Largest Supplier of Electrical and Electronic Components

Click to view similar products for [LED Lighting Reflectors](#) category:

Click to view products by [Ledil](#) manufacturer:

Other Similar products are found below :

[LL04CR-CFN35155L02](#) [LL04CR-CFN60155L02](#) [LL04CR-CGM85135L02](#) [F13185_GERI-RZ](#) [10604](#) [LL01SP-ATH15R49](#) [10170](#) [12527](#)
[12531](#) [12568](#) [C13253_TINA2-R-CLIP16](#) [CA14591_BROOKE-XW](#) [F15560_MIRELLA-G2-W](#) [CA11525_LAURA-R-W](#) [12796](#) [LMH020-](#)
[REFL-0000-0000062](#) [LMH020-REFL-0000-0000082](#) [C12606_LENINA-DL](#) [CN12711_LENINA-W-DL](#) [C11394_TYRA-S](#) [C11396_TYRA-](#)
[W](#) [C11508_BROOKE-W](#) [C11552_BARBARA-S](#) [C11553_BARBARA-W](#) [C11862_MINNIE-W](#) [C11979_LENA-S](#) [C11980_LENA-W](#)
[C11996_LENA-LENS](#) [C12083_BROOKE-SCR-M](#) [C12095_MINNIE-M](#) [C12097_MINNIE-WWW](#) [C12154_LENA-M](#) [C12469_LISA2-R-](#)
[PIN](#) [C12476_MIRELLA-50-S](#) [C12477_MIRELLA-50-M](#) [C12480_MIRELLA-50-S-PIN](#) [C12516_RITA-WAS](#) [C12597_LENINA-S](#)
[C12599_LENINA-W](#) [C12948_LENA-WAS](#) [C12958_LENINA-XW](#) [C13085_MIRELLA-50-S-PF](#) [C13087_MIRELLA-50-W-PF](#)
[C13101_LENA-X-WAS](#) [C13555_BRIDGET-W-UNI](#) [C13556_BRIDGET-M-UNI](#) [C13557_BRIDGET-S-UNI](#) [C14346_ANGELETTE-WAS](#)
[C17099_ALISE-50-DL](#) [C17095_ALISE-70-CL](#)