

LENINA-W

~55° wide beam

TECHNICAL SPECIFICATIONS:

Dimensions	Ø 74.0 mm
Height	40 mm
Fastening	socket
ROHS compliant	yes ⓘ

MATERIAL SPECIFICATIONS:

Component	Type	Material
LENINA-W	Reflector	PC

ORDERING INFORMATION:

Component
C12599_LENINA-W
» Box size: 476 x 273 x 197 mm







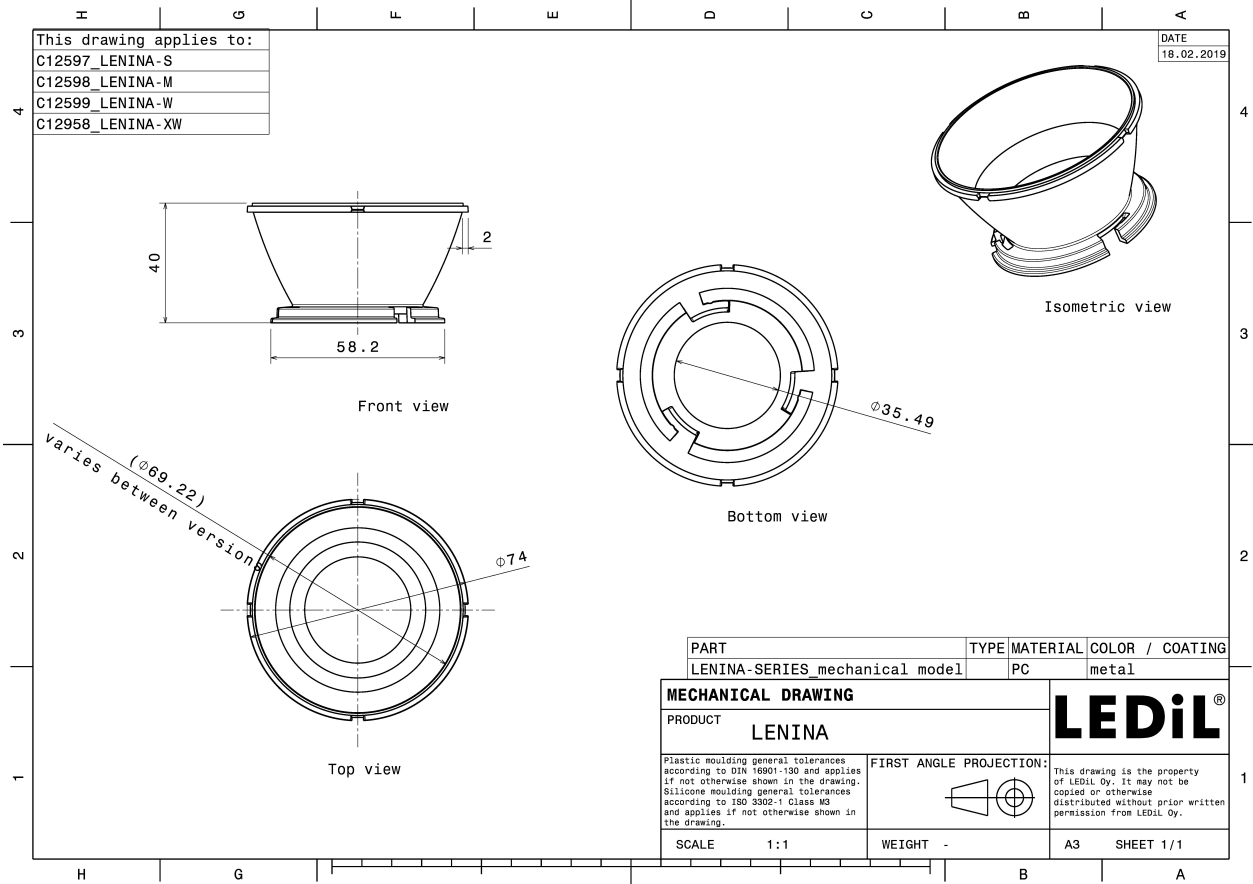

Colour	Finish	Coating
metal		lacquer

Qty in box	MOQ	MPQ	Box weight (kg)
60	120	60	2.0

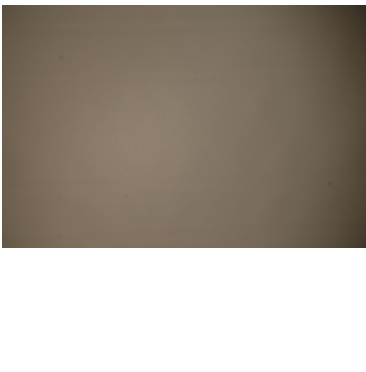
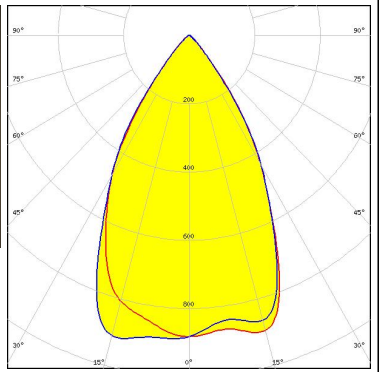

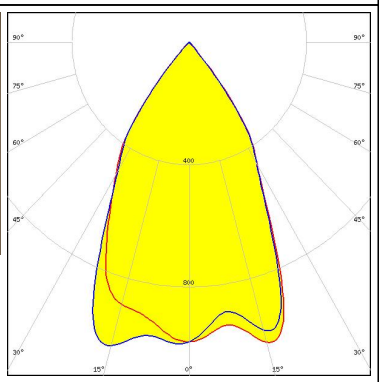

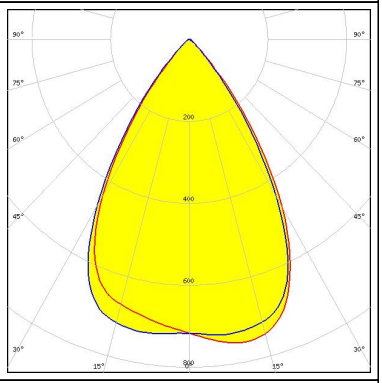

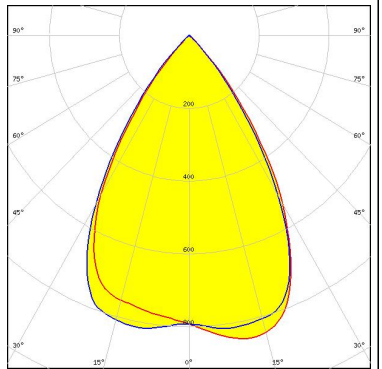



See also our general installation guide: www.ledil.com/installation_guide

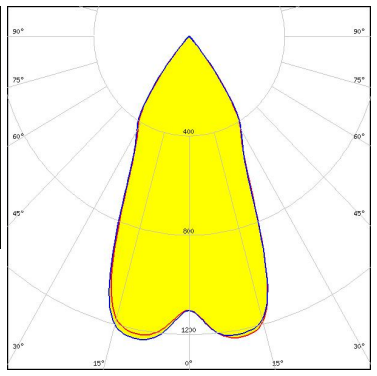

PHOTOMETRIC DATA (MEASURED):

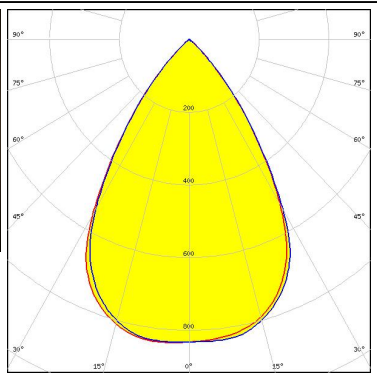
<p></p> <p>LED BXRA ES Rectangle FWHM / FWTM 60.0° / 84.0° Efficiency 86 % Peak intensity 0.9 cd/m LEDs/each optic 1 Light colour White</p> <p>Required components: C12153_LENINA-STD-BASE-BXRA C12606_LENINA-DL</p>		
<p></p> <p>LED BXRA ES Rectangle FWHM / FWTM 58.0° / 82.0° Efficiency 91 % Peak intensity 1.1 cd/m LEDs/each optic 1 Light colour White</p> <p>Required components: C12153_LENINA-STD-BASE-BXRA</p>		
<p></p> <p>LED BXRA RS FWHM / FWTM 60.0° / 89.0° Efficiency 80 % Peak intensity 0.8 cd/m LEDs/each optic 1 Light colour White</p> <p>Required components: C12229_LENINA-STD-BASE-RS C12606_LENINA-DL</p>		
<p></p> <p>LED BXRA RS FWHM / FWTM 64.0° / 87.0° Efficiency 88 % Peak intensity 0.9 cd/m LEDs/each optic 1 Light colour White</p> <p>Required components: C12229_LENINA-STD-BASE-RS</p>		

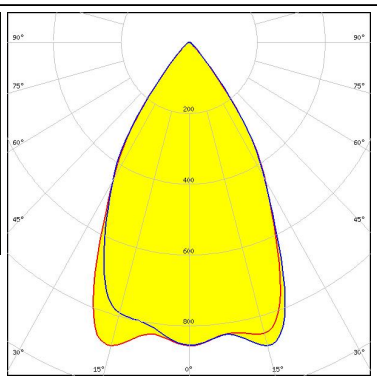
PHOTOMETRIC DATA (MEASURED):

<p></p> <p>LED V10 Gen6</p> <p>FWHM / FWTM 47.0° / 80.0°</p> <p>Efficiency 83 %</p> <p>Peak intensity 1.3 cd/m</p> <p>LEDs/each optic 1</p> <p>Light colour White</p> <p>Required components: C13186_LENINA-STD-BASE-CXA15 C12606_LENINA-DL</p>		
<p></p> <p>LED V4 HD</p> <p>FWHM / FWTM 48.0° / 79.0°</p> <p>Efficiency 91 %</p> <p>Peak intensity 1.2 cd/m</p> <p>LEDs/each optic 1</p> <p>Light colour White</p> <p>Required components: C14146_LENINA-STD-BASE-CXA18</p>		
<p></p> <p>LED Vero SE 29</p> <p>FWHM / FWTM 66.0° / 90.0°</p> <p>Efficiency 91 %</p> <p>Peak intensity 0.8 cd/m</p> <p>LEDs/each optic 1</p> <p>Light colour White</p> <p>Required components: C15083_LENINA-STD-BASE-VERO29</p>		
<p></p> <p>LED VERO13</p> <p>FWHM / FWTM 60.0° / 84.0°</p> <p>Efficiency 85 %</p> <p>Peak intensity 0.9 cd/m</p> <p>LEDs/each optic 1</p> <p>Light colour White</p> <p>Required components: C13868_LENINA-STD-BASE-VERO13-18 C12606_LENINA-DL</p>		

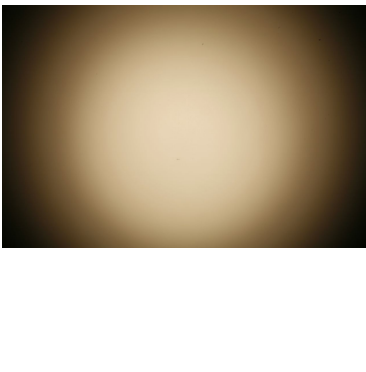
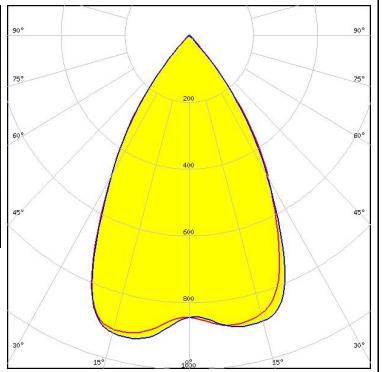
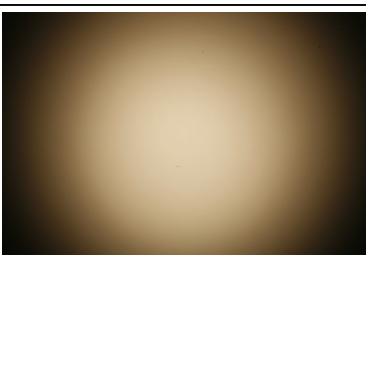
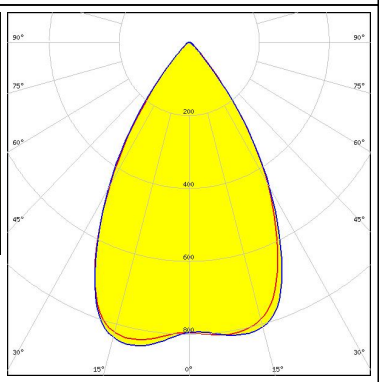
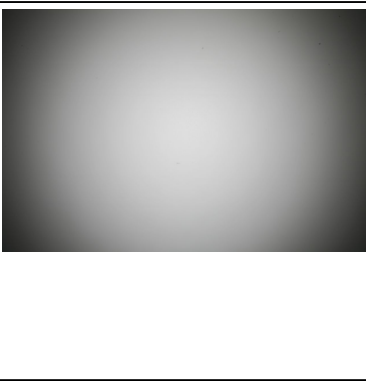
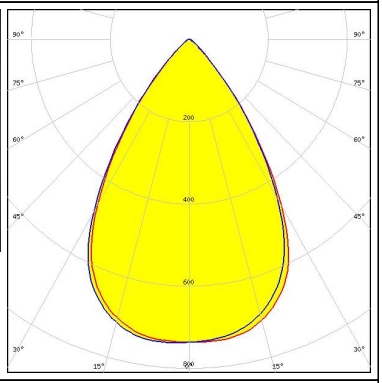
PHOTOMETRIC DATA (MEASURED):

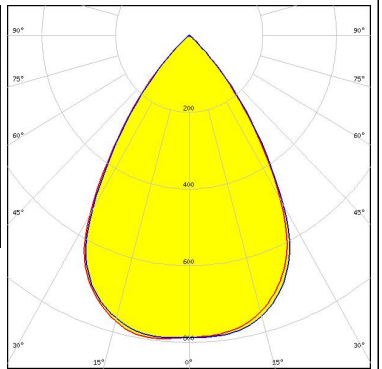
<p>bridgelux.</p> <p>LED VERO18</p> <p>FWHM / FWTM 64.0° / 85.0°</p> <p>Efficiency 89 %</p> <p>Peak intensity 0.9 cd/m</p> <p>LEDs/each optic 1</p> <p>Light colour White</p> <p>Required components: C13868_LENINA-STD-BASE-VERO13-18</p>		
<p>bridgelux.</p> <p>LED VERO18</p> <p>FWHM / FWTM 64.0° / 86.0°</p> <p>Efficiency 85 %</p> <p>Peak intensity 0.9 cd/m</p> <p>LEDs/each optic 1</p> <p>Light colour White</p> <p>Required components: C13868_LENINA-STD-BASE-VERO13-18 C12606_LENINA-DL</p>		
<p>bridgelux.</p> <p>LED VERO29</p> <p>FWHM / FWTM 67.0° / 92.0°</p> <p>Efficiency 84 %</p> <p>Peak intensity 0.7 cd/m</p> <p>LEDs/each optic 1</p> <p>Light colour White</p> <p>Required components: C13867_LENINA-STD-BASE-VERO29 C12606_LENINA-DL</p>		
<p>bridgelux.</p> <p>LED VERO29</p> <p>FWHM / FWTM 67.0° / 91.0°</p> <p>Efficiency 88 %</p> <p>Peak intensity 0.8 cd/m</p> <p>LEDs/each optic 1</p> <p>Light colour White</p> <p>Required components: C13867_LENINA-STD-BASE-VERO29</p>		

PHOTOMETRIC DATA (MEASURED):

CITIZEN

LED CL-L340
 FWHM / FWTM 50.0° / 83.0°
 Efficiency 78 %
 LEDs/each optic 1
 Light colour White
 Required components:
 C11995_LENINA-STD-BASE-CL340
 C12606_LENINA-DL

CITIZEN

LED CL-L340
 FWHM / FWTM 48.0° / 80.0°
 Efficiency 86 %
 LEDs/each optic 1
 Light colour White
 Required components:
 C11995_LENINA-STD-BASE-CL340

CITIZEN

LED CL-L340
 FWHM / FWTM 53.0° / 81.0°
 Efficiency 91 %
 Peak intensity 1.1 cd/lm
 LEDs/each optic 1
 Light colour White
 Required components:
 C11995_LENINA-STD-BASE-CL340

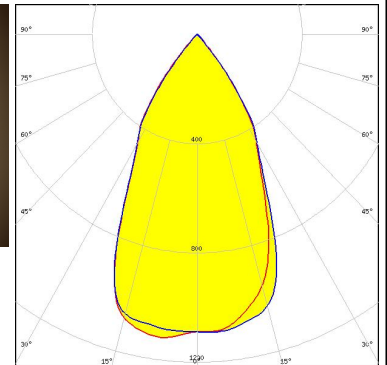
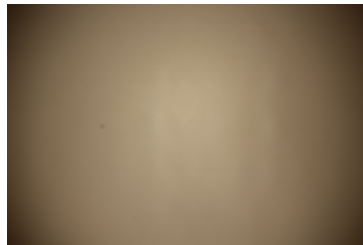

CITIZEN

LED CLL02x/CLU02x (LES10)
 FWHM / FWTM 57.0° / 82.0°
 Efficiency 86 %
 Peak intensity 1 cd/lm
 LEDs/each optic 1
 Light colour White
 Required components:
 C13868_LENINA-STD-BASE-VERO13-18
 C12606_LENINA-DL
 Bender Wirth: 434 Typ L1

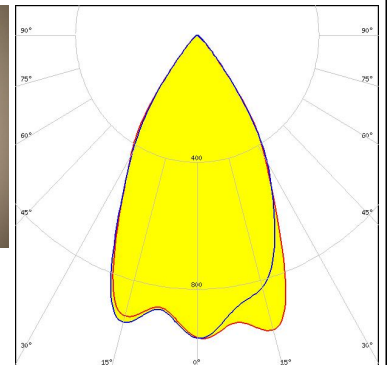
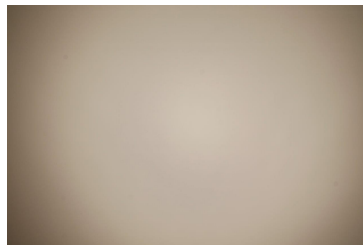

PHOTOMETRIC DATA (MEASURED):

CITIZEN

LED CLL03x/CLU03x
 FWHM / FWTM 58.0° / 84.0°
 Efficiency 86 %
 Peak intensity 1 cd/lm
 LEDs/each optic 1
 Light colour White
 Required components:
 C12691_LENINA-STD-BASE-CLL030
 C12606_LENINA-DL

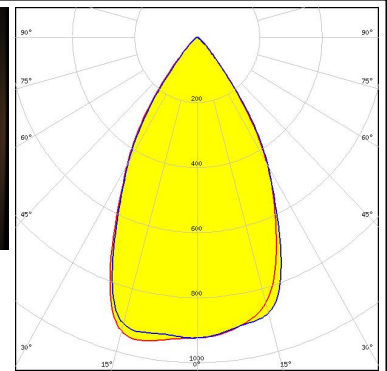
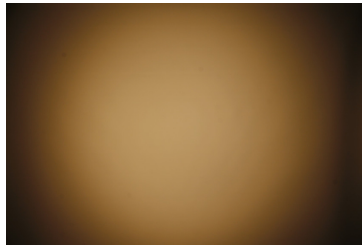

CITIZEN

LED CLL03x/CLU03x
 FWHM / FWTM 60.0° / 83.0°
 Efficiency 86 %
 Peak intensity 1 cd/lm
 LEDs/each optic 1
 Light colour White
 Required components:
 C13868_LENINA-STD-BASE-VERO13-18
 C12606_LENINA-DL
 Bender Wirth: 433 Typ L1

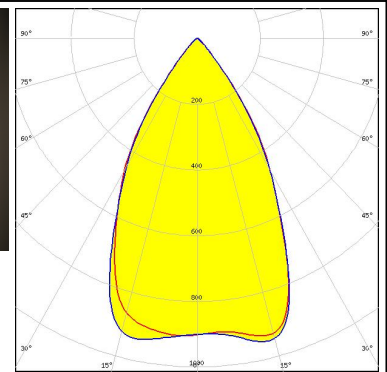
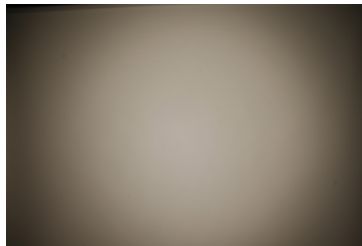

CITIZEN

LED CLL03x/CLU03x
 FWHM / FWTM 56.0° / 82.0°
 Efficiency 90 %
 Peak intensity 1.1 cd/lm
 LEDs/each optic 1
 Light colour White
 Required components:
 C12691_LENINA-STD-BASE-CLL030

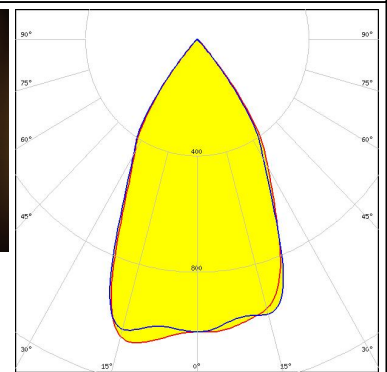
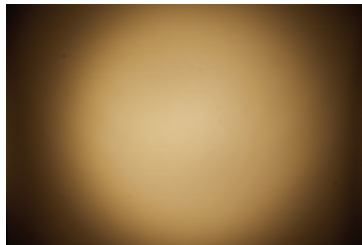

CITIZEN

LED CLL04x/CLU04x
 FWHM / FWTM 61.0° / 87.0°
 Efficiency 86 %
 Peak intensity 0.9 cd/lm
 LEDs/each optic 1
 Light colour White
 Required components:
 C13867_LENINA-STD-BASE-VERO29
 C12606_LENINA-DL
 Bender Wirth: 431 Typ L3

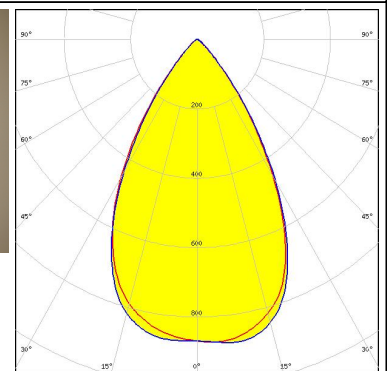
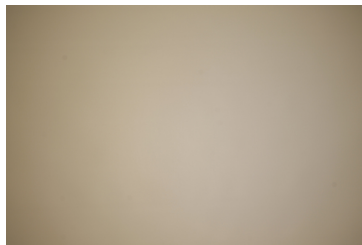

PHOTOMETRIC DATA (MEASURED):

CITIZEN

LED CLL04x/CLU04x
 FWHM / FWTM 58.0° / 85.0°
 Efficiency 78 %
 Peak intensity 0.9 cd/lm
 LEDs/each optic 1
 Light colour White
 Required components:
 C12606_LENINA-DL
 A.A.G. STUCCHI: 8102-G2 + S-8000-12

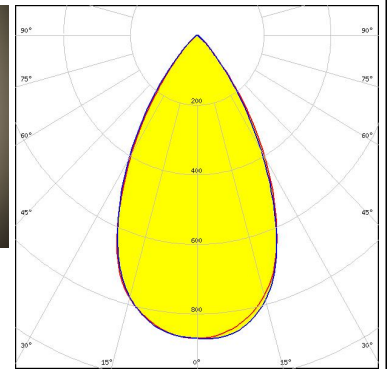
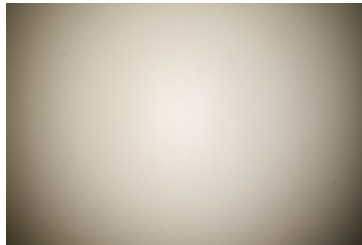

CITIZEN

LED CLL04x/CLU04x
 FWHM / FWTM 55.0° / 84.0°
 Efficiency 86 %
 Peak intensity 1 cd/lm
 LEDs/each optic 1
 Light colour White
 Required components:
 C12606_LENINA-DL
 IDEAL: 50-2204CT + 50-2100LN

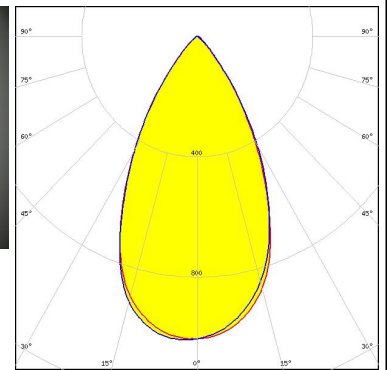

CITIZEN

LED CLL04x/CLU04x
 FWHM / FWTM 61.0° / 85.0°
 Efficiency 91 %
 Peak intensity 1 cd/lm
 LEDs/each optic 1
 Light colour White
 Required components:
 C13867_LENINA-STD-BASE-VERO29
 Bender Wirth: 431 Typ L3

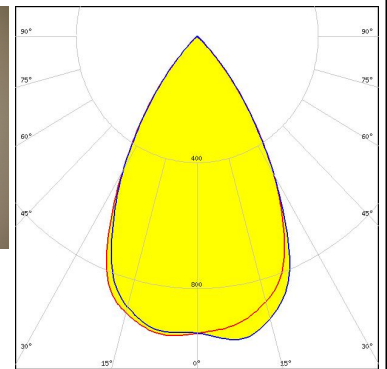
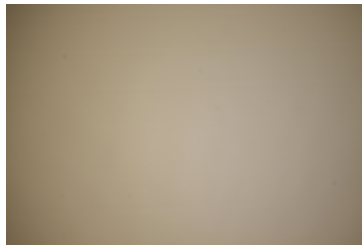

CITIZEN

LED CLL04x/CLU04x
 FWHM / FWTM 56.0° / 87.0°
 Efficiency 76 %
 Peak intensity 0.9 cd/lm
 LEDs/each optic 1
 Light colour White
 Required components:
 C12692_LENINA-STD-BASE-CLL040
 C12606_LENINA-DL

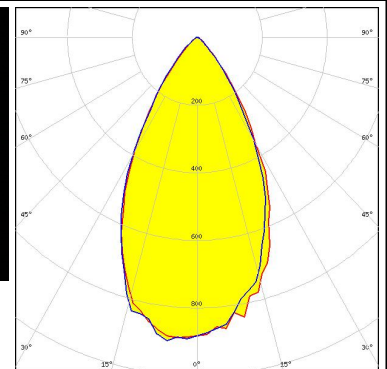
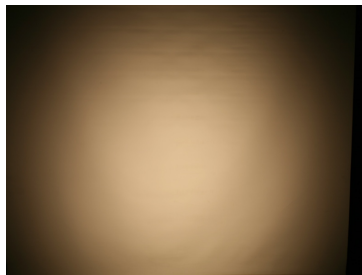

PHOTOMETRIC DATA (MEASURED):

CITIZEN

LED CLL04x/CLU04x
 FWHM / FWTM 57.0° / 84.0°
 Efficiency 82 %
 Peak intensity 1 cd/lm
 LEDs/each optic 1
 Light colour White
 Required components:
 A.A.G. STUCCHI: 8102-G2 + S-8000-12

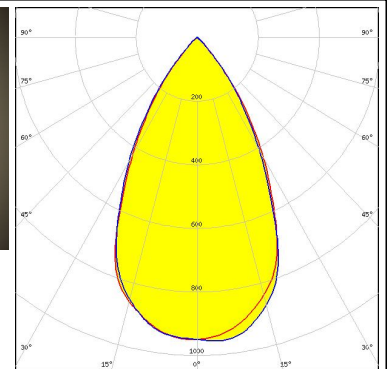
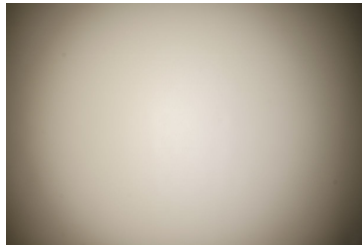

CITIZEN

LED CLL04x/CLU04x
 FWHM / FWTM 54.0° / 83.0°
 Efficiency 87 %
 Peak intensity 1.1 cd/lm
 LEDs/each optic 1
 Light colour White
 Required components:
 IDEAL: 50-2204CT + 50-2100LN

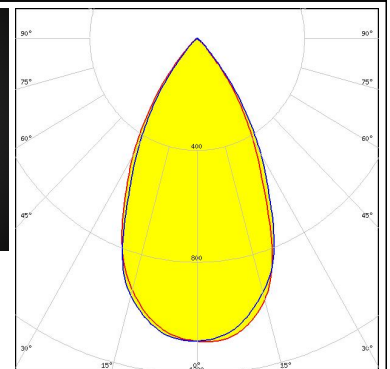
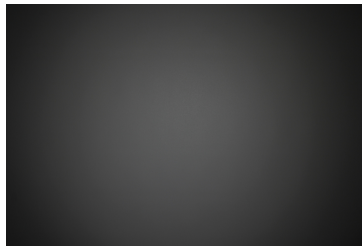

CITIZEN

LED CLL04x/CLU04x
 FWHM / FWTM 59.0° / 85.0°
 Efficiency 84 %
 Peak intensity 1 cd/lm
 LEDs/each optic 1
 Light colour White
 Required components:
 C12692_LENINA-STD-BASE-CLL040

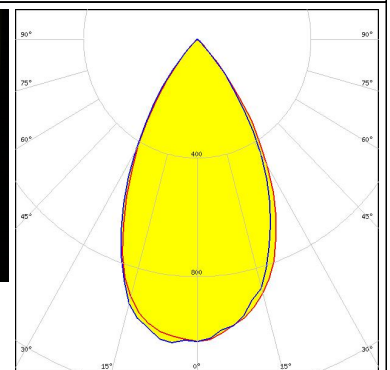
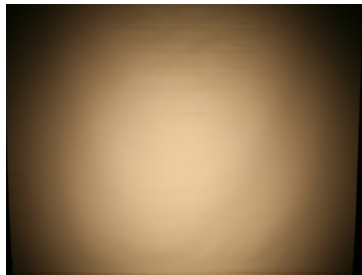

CITIZEN

LED CLU710/711
 FWHM / FWTM 55.0° / 82.0°
 Efficiency 89 %
 Peak intensity 1 cd/lm
 LEDs/each optic 1
 Light colour White
 Required components:
 C12691_LENINA-STD-BASE-CLL030
 C12606_LENINA-DL

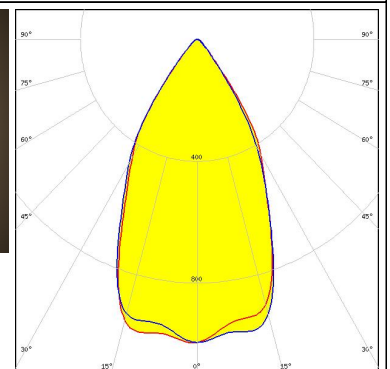
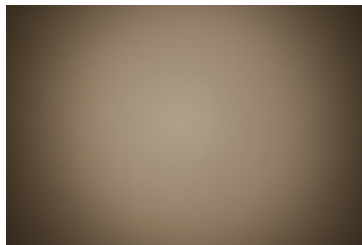

PHOTOMETRIC DATA (MEASURED):

CITIZEN

LED CLU720/721
 FWHM / FWTM 57.0° / 83.0°
 Efficiency 83 %
 Peak intensity 0.9 cd/lm
 LEDs/each optic 1
 Light colour White
 Required components:
 C12691_LENINA-STD-BASE-CLL030
 C12606_LENINA-DL

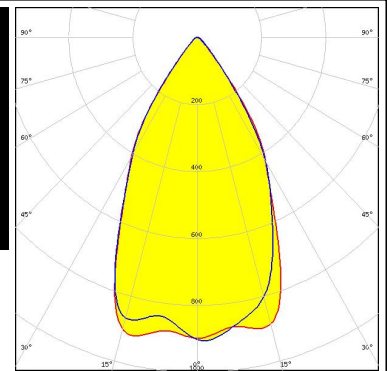
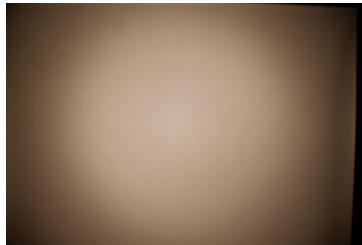

CITIZEN

LED CLU720/721
 FWHM / FWTM 54.0° / 81.0°
 Efficiency 87 %
 Peak intensity 1 cd/lm
 LEDs/each optic 1
 Light colour White
 Required components:
 C12691_LENINA-STD-BASE-CLL030

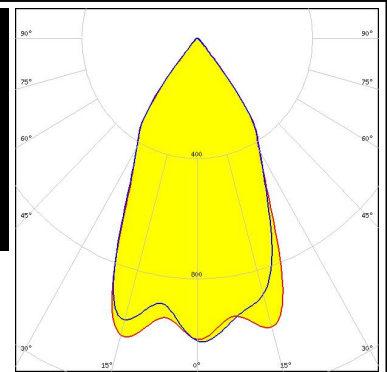
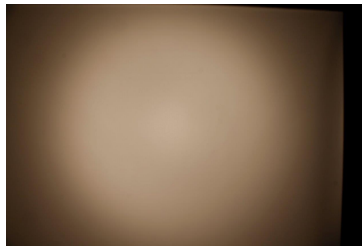

CITIZEN

LED CLU730/731
 FWHM / FWTM 50.0° / 82.0°
 Efficiency 83 %
 Peak intensity 1 cd/lm
 LEDs/each optic 1
 Light colour White
 Required components:
 C12692_LENINA-STD-BASE-CLL040
 C12606_LENINA-DL

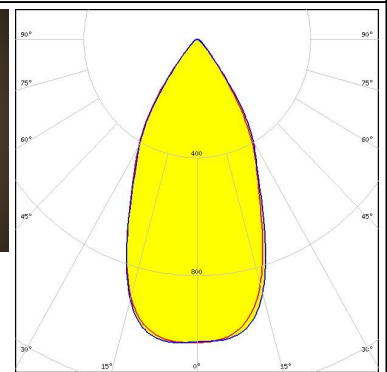
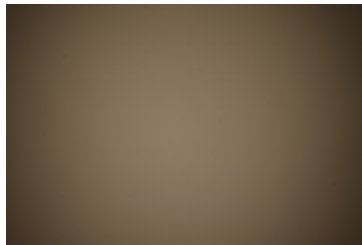





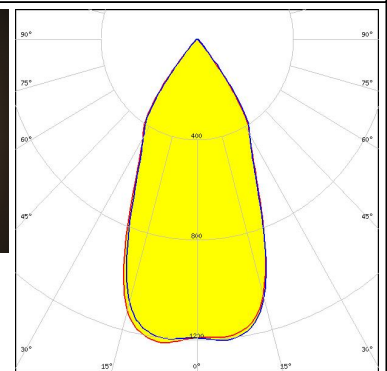
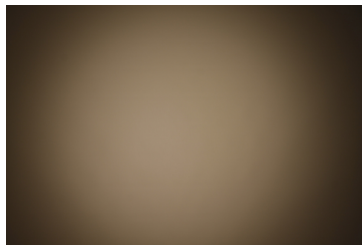

CITIZEN

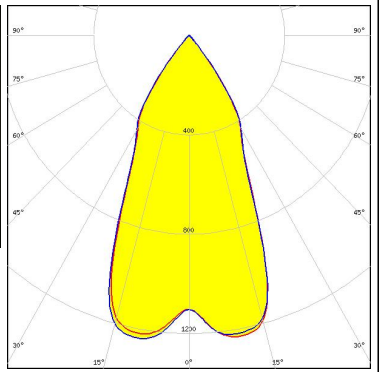
LED CLU730/731
 FWHM / FWTM 49.0° / 80.0°
 Efficiency 93 %
 Peak intensity 1.2 cd/lm
 LEDs/each optic 1
 Light colour White
 Required components:
 C12692_LENINA-STD-BASE-CLL040

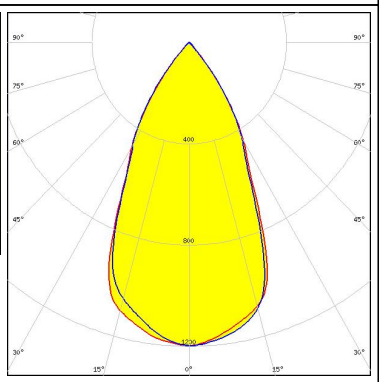

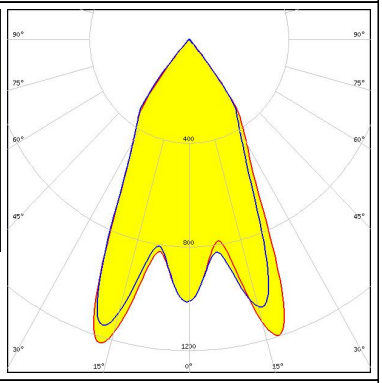
PHOTOMETRIC DATA (MEASURED):

<p>CREE → LED</p> <p>LED CMA1840 FWHM / FWTM 48.0° / 79.0° Efficiency 91 % Peak intensity 1.2 cd/lm LEDs/each optic 1 Light colour White Required components: C14146_LENASTD-BASE-CXA18</p>		
<p>CREE → LED</p> <p>LED CMA2550 FWHM / FWTM 51.0° / 80.0° Efficiency 91 % Peak intensity 1.2 cd/lm LEDs/each optic 1 Light colour White Required components: C13324_LENASTD-BASE-CXA25</p>		
<p>CREE → LED</p> <p>LED CMT14xx FWHM / FWTM 55.0° / 81.0° Efficiency 91 % Peak intensity 1.2 cd/lm LEDs/each optic 1 Light colour White Required components: C13868_LENASTD-BASE-VERO13-18 Bender Wirth: 434 Typ L1</p>		
<p>CREE → LED</p> <p>LED CMT19xx FWHM / FWTM 54.0° / 81.0° Efficiency 91 % Peak intensity 1.1 cd/lm LEDs/each optic 1 Light colour White Required components: C12691_LENASTD-BASE-CLL030 Bender Wirth: 477 Typ L1</p>		

PHOTOMETRIC DATA (MEASURED):

CREE LED

LED CMT19xx
 FWHM / FWTM 55.0° / 82.0°
 Efficiency 91 %
 Peak intensity 1.1 cd/lm
 LEDs/each optic 1
 Light colour White
 Required components:
 C13868_LENINA-STD-BASE-VERO13-18
 Bender Wirth: 477 Typ L1

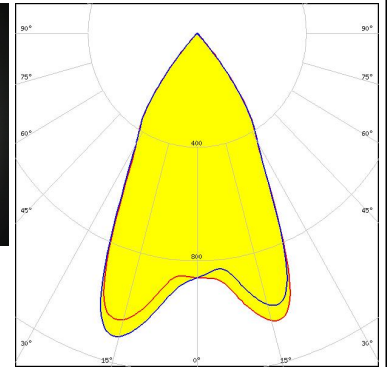
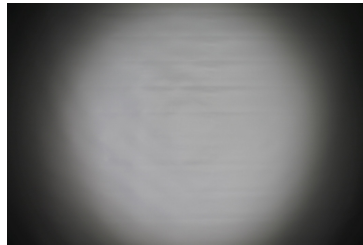

CREE LED

LED CMT28xx
 FWHM / FWTM 60.0° / 84.0°
 Efficiency 91 %
 Peak intensity 1 cd/lm
 LEDs/each optic 1
 Light colour White
 Required components:
 C13867_LENINA-STD-BASE-VERO29
 Bender Wirth: 471 Typ L3

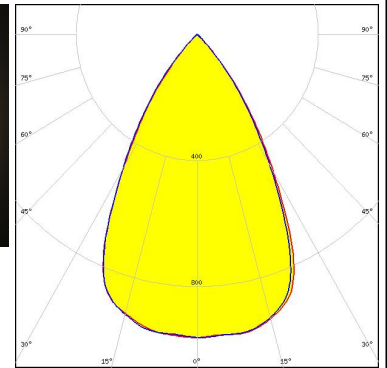
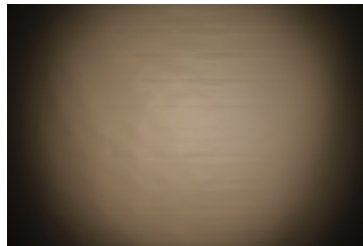

CREE LED

LED CMT28xx
 FWHM / FWTM 56.0° / 82.0°
 Efficiency 92 %
 Peak intensity 1.1 cd/lm
 LEDs/each optic 1
 Light colour White
 Required components:
 C12692_LENINA-STD-BASE-CLL040

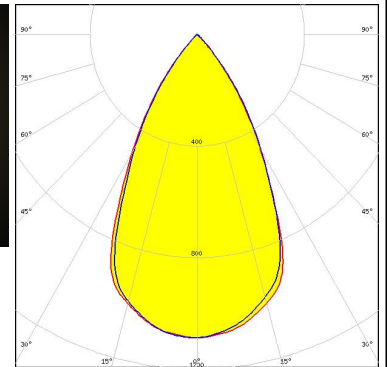
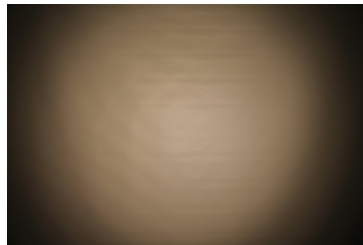





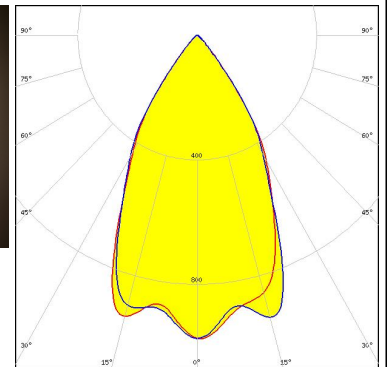
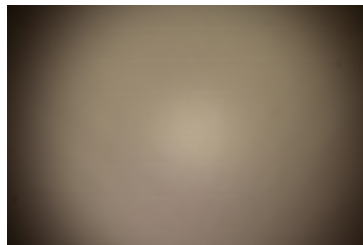

CREE LED

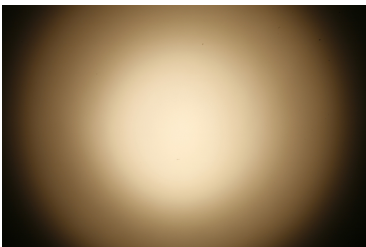
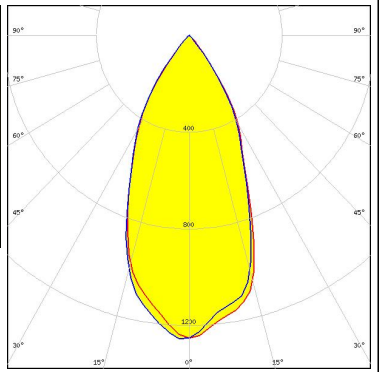
LED CXA/B 15xx
 FWHM / FWTM 57.0° / 82.0°
 Efficiency 86 %
 Peak intensity 1 cd/lm
 LEDs/each optic 1
 Light colour White
 Required components:
 C13868_LENINA-STD-BASE-VERO13-18
 C12606_LENINA-DL
 Bender Wirth: 441 Typ L1

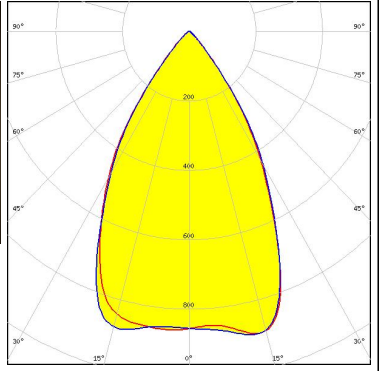

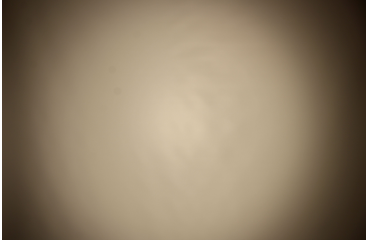
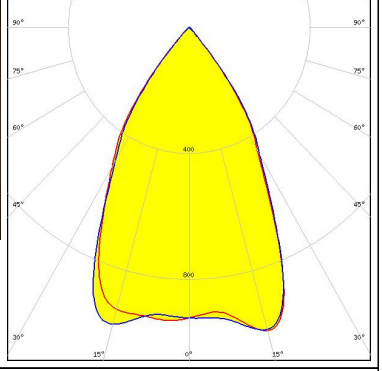
PHOTOMETRIC DATA (MEASURED):

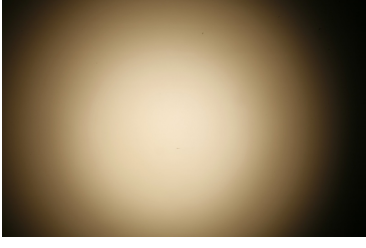
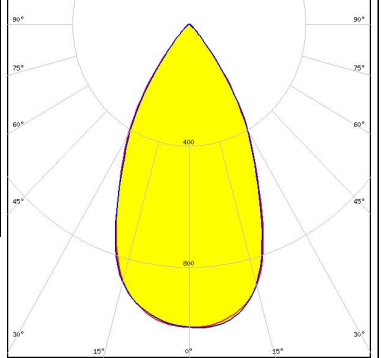
<p>CREE  LED</p> <p>LED CXA/B 15xx FWHM / FWTM 48.0° / 79.0° Efficiency 83 % Peak intensity 1.3 cd/lm LEDs/each optic 1 Light colour White</p> <p>Required components: C13186_LENINA-STD-BASE-CXA15 C12606_LENINA-DL</p>		
<p>CREE  LED</p> <p>LED CXA/B 1830 FWHM / FWTM 61.0° / 85.0° Efficiency 86 % Peak intensity 0.9 cd/lm LEDs/each optic 1 Light colour White</p> <p>Required components: C13868_LENINA-STD-BASE-VERO13-18 C12606_LENINA-DL Bender Wirth: 437 Typ L1</p>		
<p>CREE  LED</p> <p>LED CXA/B 1830 FWHM / FWTM 60.0° / 83.0° Efficiency 91 % Peak intensity 1 cd/lm LEDs/each optic 1 Light colour White</p> <p>Required components: C13868_LENINA-STD-BASE-VERO13-18 Bender Wirth: 437 Typ L1</p>		
<p>CREE  LED</p> <p>LED CXA/B 25xx FWHM / FWTM 52.0° / 80.0° Efficiency 76 % Peak intensity 1.1 cd/lm LEDs/each optic 1 Light colour White</p> <p>Required components: C13324_LENINA-STD-BASE-CXA25 C12606_LENINA-DL</p>		

PHOTOMETRIC DATA (MEASURED):

CREE LED

LED CXA/B 25xx
 FWHM / FWTM 51.0° / 80.0°
 Efficiency 84 %
 Peak intensity 1.2 cd/lm
 LEDs/each optic 1
 Light colour White
 Required components:
 C13324_LENINA-STD-BASE-CXA25

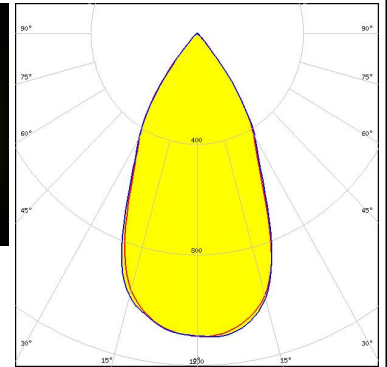
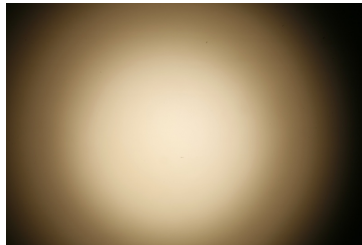

CREE LED

LED CXA2011
 FWHM / FWTM 52.0° / 83.0°
 Efficiency 78 %
 Peak intensity 1 cd/lm
 LEDs/each optic 1
 Light colour White
 Required components:
 C12105_LENINA-STD-BASE-CXA20
 C12606_LENINA-DL

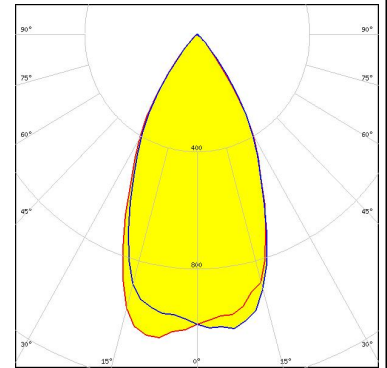

CREE LED

LED CXA2011
 FWHM / FWTM 50.0° / 80.0°
 Efficiency 86 %
 Peak intensity 1.2 cd/lm
 LEDs/each optic 1
 Light colour White
 Required components:
 C12105_LENINA-STD-BASE-CXA20

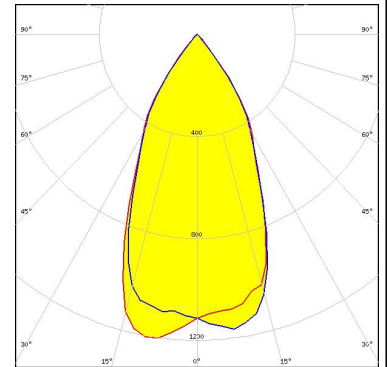

EVERLIGHT

LED CHI3030 19W
 FWHM / FWTM 62.0° / 88.0°
 Efficiency 90 %
 Peak intensity 0.9 cd/lm
 LEDs/each optic 1
 Light colour White
 Required components:
 C13867_LENINA-STD-BASE-VERO29
 C12606_LENINA-DL
 Bender Wirth: 468 Typ L3

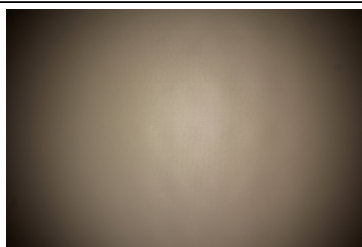

PHOTOMETRIC DATA (MEASURED):

EVERLIGHT

LED CHI3030 29W
 FWHM / FWTM 63.0° / 92.0°
 Efficiency 86 %
 Peak intensity 0.8 cd/lm
 LEDs/each optic 1
 Light colour White

Required components:

C13867_LENINA-STD-BASE-VERO29
 C12606_LENINA-DL
 Bender Wirth: 468 Typ L3

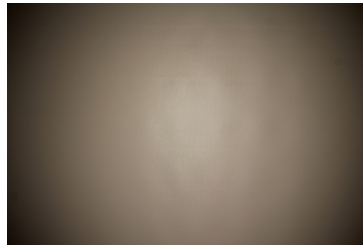

LUMILEDS

LED LUXEON CoB 1204/1205
 FWHM / FWTM 55.0° / 81.0°
 Efficiency 89 %
 Peak intensity 1.1 cd/lm
 LEDs/each optic 1
 Light colour White

Required components:

C12292_LENINA-STD-BASE-MEZ

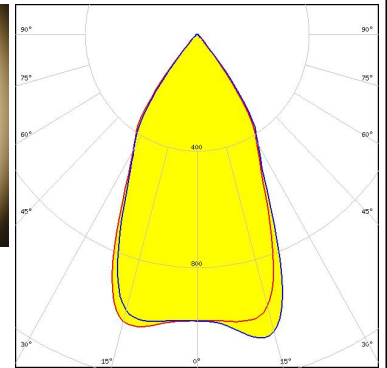

LUMILEDS

LED LUXEON CoB 1204/1205
 FWHM / FWTM 57.0° / 82.0°
 Efficiency 84 %
 Peak intensity 1 cd/lm
 LEDs/each optic 1
 Light colour White

Required components:

C12292_LENINA-STD-BASE-MEZ
 C12606_LENINA-DL

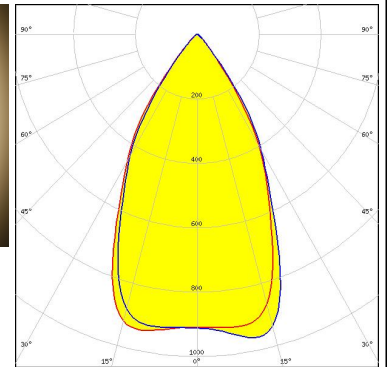

LUMILEDS

LED LUXEON CoB 1204HD
 FWHM / FWTM 51.0° / 79.0°
 Efficiency 91 %
 Peak intensity 1.4 cd/lm
 LEDs/each optic 1
 Light colour White

Required components:

C11981_LENINA-STD-BASE-COB-L110

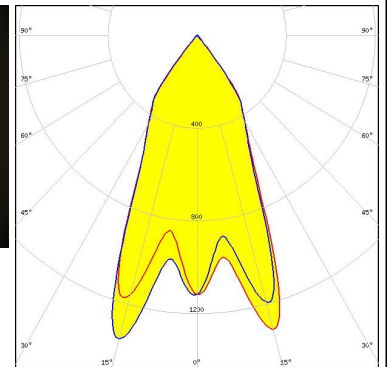
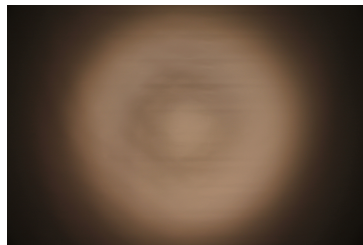

PHOTOMETRIC DATA (MEASURED):

LUMILEDS

LED LUXEON CoB 1205HD
 FWHM / FWTM 54.0° / 80.0°
 Efficiency 91 %
 Peak intensity 1.3 cd/lm
 LEDs/each optic 1
 Light colour White
 Required components:
 C11981_LENASTD-BASE-COB-L110

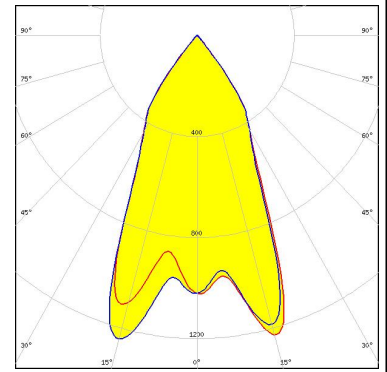

LUMILEDS

LED LUXEON CoB 1208
 FWHM / FWTM 58.0° / 82.0°
 Efficiency 88 %
 Peak intensity 1 cd/lm
 LEDs/each optic 1
 Light colour White
 Required components:
 C12292_LENASTD-BASE-MEZ

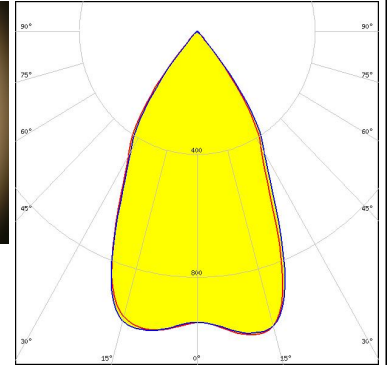
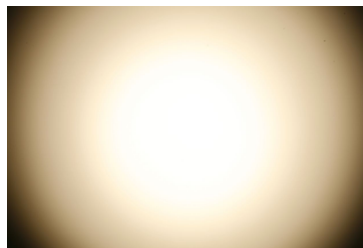

LUMILEDS

LED LUXEON CoB 1208
 FWHM / FWTM 60.0° / 83.0°
 Efficiency 84 %
 Peak intensity 0.9 cd/lm
 LEDs/each optic 1
 Light colour White
 Required components:
 C12292_LENASTD-BASE-MEZ
 C12606_LENINA-DL

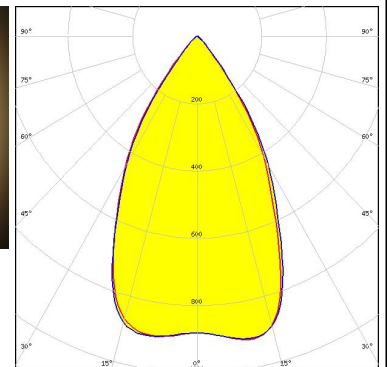
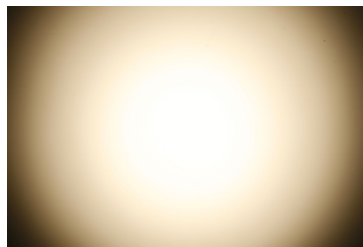

LUMILEDS

LED LUXEON CoB 1211
 FWHM / FWTM 60.0° / 86.0°
 Efficiency 86 %
 Peak intensity 0.9 cd/lm
 LEDs/each optic 1
 Light colour White
 Required components:
 C13867_LENASTD-BASE-VERO29
 C12606_LENINA-DL
 Bender Wirth: 431 Typ L3

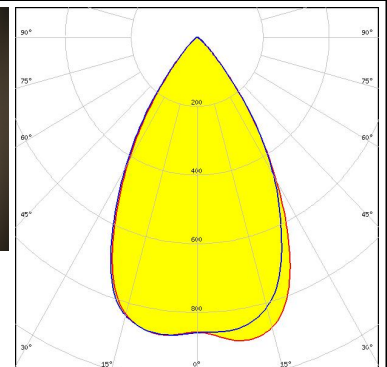
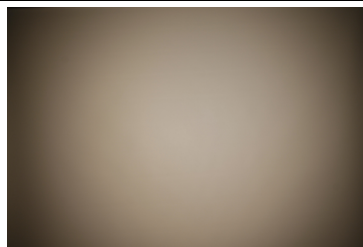

PHOTOMETRIC DATA (MEASURED):

LUMILEDS

LED LUXEON CoB 1211
 FWHM / FWTM 60.0° / 84.0°
 Efficiency 91 %
 Peak intensity 1 cd/lm
 LEDs/each optic 1
 Light colour White
 Required components:
 C13867_LENINA-STD-BASE-VERO29
 Bender Wirth: 431 Typ L3

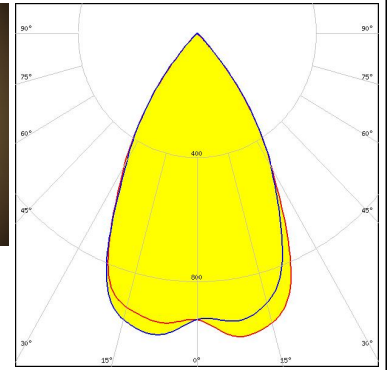
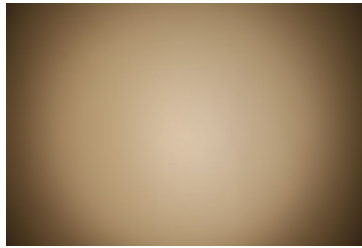

LUMILEDS

LED LUXEON CoB 1216/1812
 FWHM / FWTM 58.0° / 86.0°
 Efficiency 80 %
 Peak intensity 0.9 cd/lm
 LEDs/each optic 1
 Light colour White
 Required components:
 C12606_LENINA-DL
 A.A.G. STUCCHI: 8102-G2 + S-8000-12

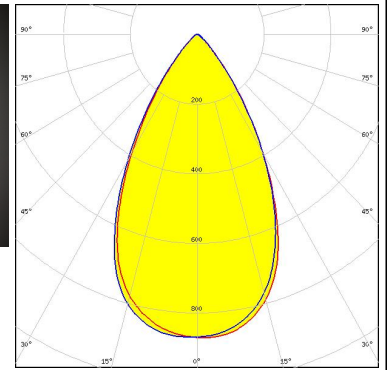
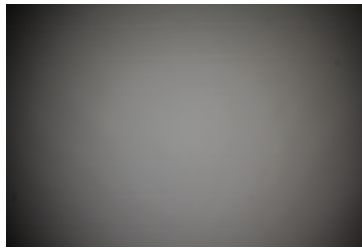

LUMILEDS

LED LUXEON CoB 1216/1812
 FWHM / FWTM 58.0° / 85.0°
 Efficiency 86 %
 Peak intensity 1 cd/lm
 LEDs/each optic 1
 Light colour White
 Required components:
 C12692_LENINA-STD-BASE-CLL040
 C12606_LENINA-DL

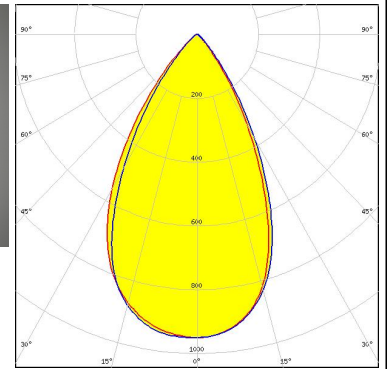

LUMILEDS

LED LUXEON CoB 1216/1812
 FWHM / FWTM 58.0° / 84.0°
 Efficiency 90 %
 Peak intensity 1 cd/lm
 LEDs/each optic 1
 Light colour White
 Required components:
 C12692_LENINA-STD-BASE-CLL040

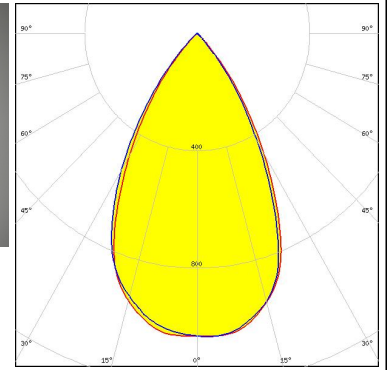



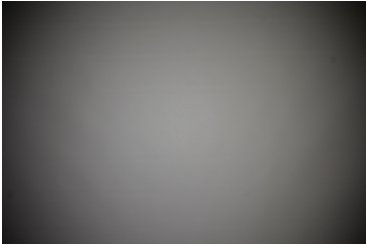
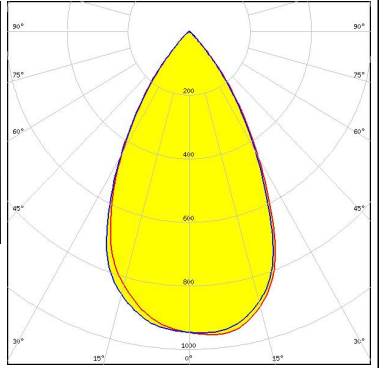
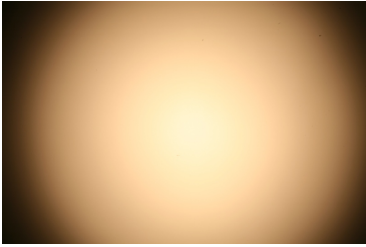
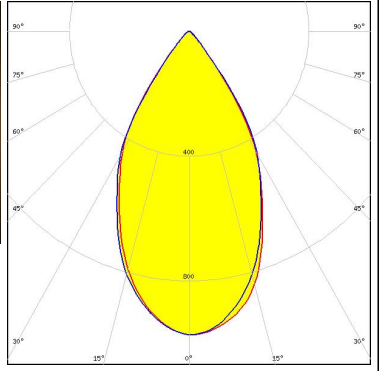
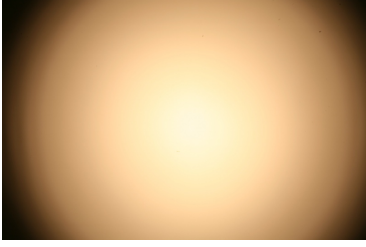
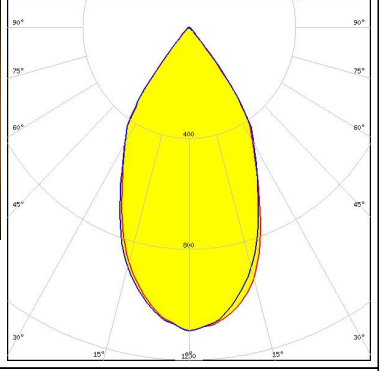
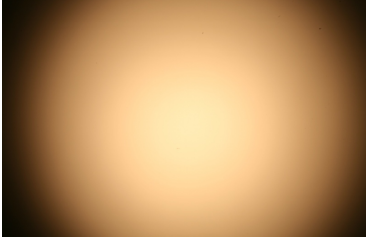
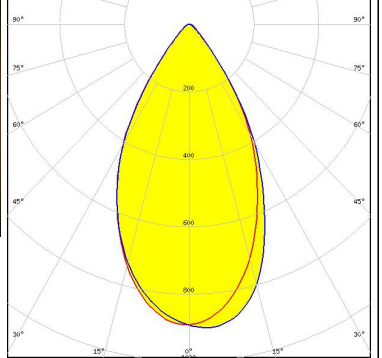

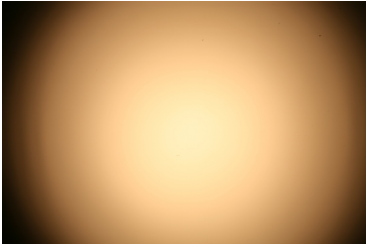
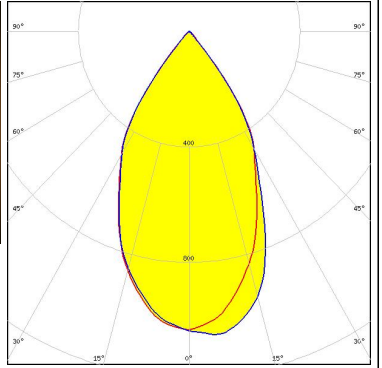
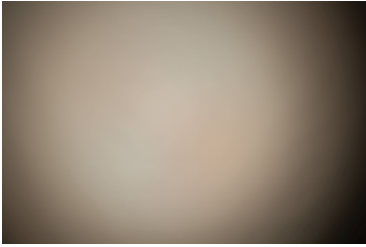
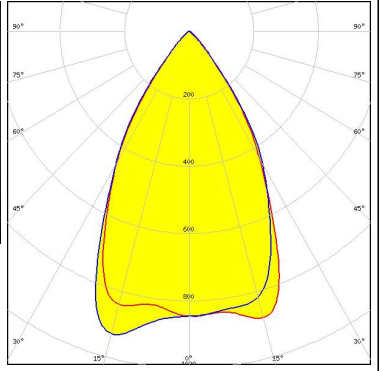
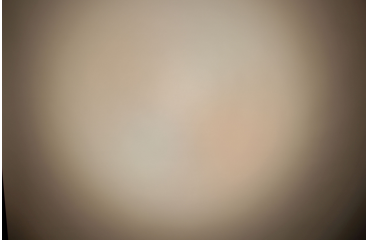
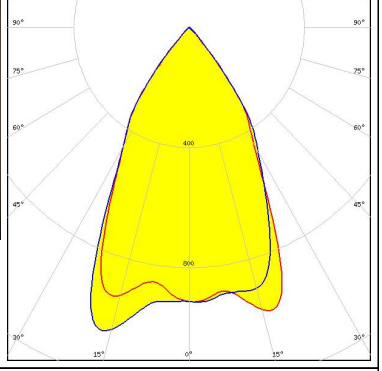
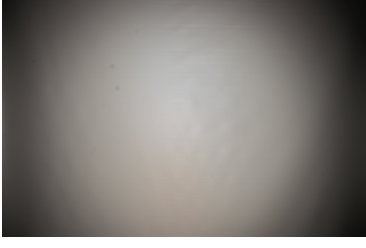
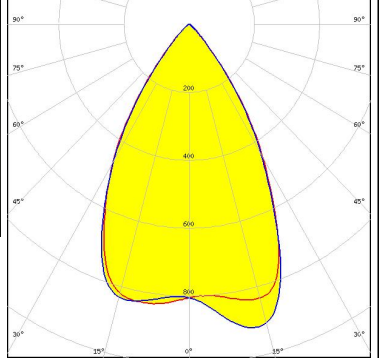

PHOTOMETRIC DATA (MEASURED):

<p>LUMILEDS</p> <p>LED LUXEON CoB 1216/1812</p> <p>FWHM / FWTM 58.0° / 85.0°</p> <p>Efficiency 84 %</p> <p>Peak intensity 1 cd/lm</p> <p>LEDs/each optic 1</p> <p>Light colour White</p> <p>Required components: A.A.G. STUCCHI: 8102-G2 + S-8000-12</p>		
<p>LUMILEDS</p> <p>LED LUXEON K12</p> <p>FWHM / FWTM 57.0° / 83.0°</p> <p>Efficiency 83 %</p> <p>Peak intensity 1 cd/lm</p> <p>LEDs/each optic 1</p> <p>Light colour White</p> <p>Required components: C12924_LENINA-STD-BASE-LUXEON-K C12606_LENINA-DL</p>		
<p>LUMILEDS</p> <p>LED LUXEON K12</p> <p>FWHM / FWTM 54.0° / 81.0°</p> <p>Efficiency 88 %</p> <p>Peak intensity 1.1 cd/lm</p> <p>LEDs/each optic 1</p> <p>Light colour White</p> <p>Required components: C12924_LENINA-STD-BASE-LUXEON-K</p>		
<p>LUMILEDS</p> <p>LED LUXEON K16</p> <p>FWHM / FWTM 56.0° / 85.0°</p> <p>Efficiency 79 %</p> <p>Peak intensity 0.9 cd/lm</p> <p>LEDs/each optic 1</p> <p>Light colour White</p> <p>Required components: C12924_LENINA-STD-BASE-LUXEON-K C12606_LENINA-DL</p>		

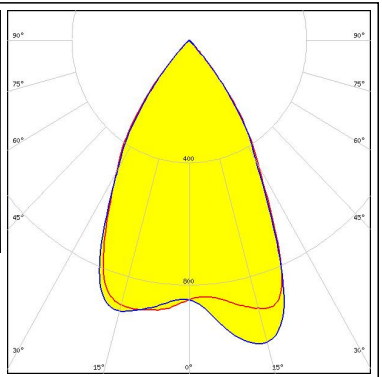
PHOTOMETRIC DATA (MEASURED):

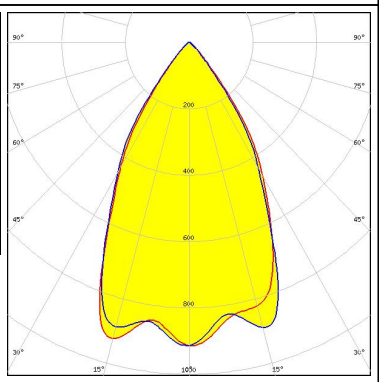
<p>LUMILEDS</p> <p>LED LUXEON K16 FWHM / FWTM 55.0° / 81.0° Efficiency 85 % Peak intensity 1.1 cd/m LEDs/each optic 1 Light colour White Required components: C12924_LENASTD-BASE-LUXEON-K</p>		
<p>LUMINUS</p> <p>LED CDM-14 (Dim-To-Warm) FWHM / FWTM 60.0° / 85.0° Efficiency 86 % Peak intensity 0.9 cd/m LEDs/each optic 1 Light colour White Required components: C13868_LENASTD-BASE-VERO13-18 C12606_LENINA-DL Bender Wirth: 491 Typ L2</p>		
<p>LUMINUS</p> <p>LED CDM-14 (Dim-To-Warm) FWHM / FWTM 58.0° / 83.0° Efficiency 91 % Peak intensity 1.1 cd/m LEDs/each optic 1 Light colour White Required components: C13868_LENASTD-BASE-VERO13-18 Bender Wirth: 491 Typ L2</p>		
<p>LUMINUS</p> <p>LED CDM-18 (Dim-To-Warm) FWHM / FWTM 62.0° / 86.0° Efficiency 86 % Peak intensity 0.9 cd/m LEDs/each optic 1 Light colour White Required components: C13868_LENASTD-BASE-VERO13-18 C12606_LENINA-DL Bender Wirth: 491 Typ L2</p>		

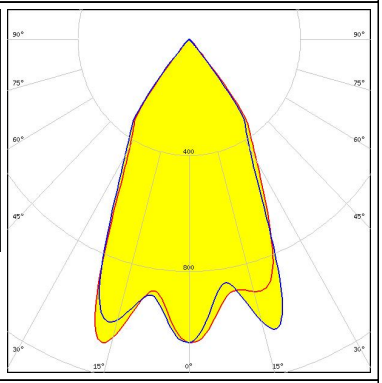
PHOTOMETRIC DATA (MEASURED):

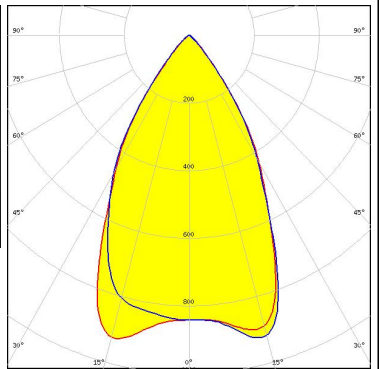
<p>LUMINUS</p> <p>LED CDM-18 (Dim-To-Warm)</p> <p>FWHM / FWTM 64.0° / 85.0°</p> <p>Efficiency 91 %</p> <p>Peak intensity 1 cd/lm</p> <p>LEDs/each optic 1</p> <p>Light colour White</p> <p>Required components: C13868_LENINA-STD-BASE-VERO13-18 Bender Wirth: 491 Typ L2</p>		
<p>LUMINUS</p> <p>LED CDM-9 (Dim-To-Warm)</p> <p>FWHM / FWTM 59.0° / 83.0°</p> <p>Efficiency 86 %</p> <p>Peak intensity 1 cd/lm</p> <p>LEDs/each optic 1</p> <p>Light colour White</p> <p>Required components: C13868_LENINA-STD-BASE-VERO13-18 C12606_LENINA-DL Bender Wirth: 490 Typ L1</p>		
<p>LUMINUS</p> <p>LED CDM-9 (Dim-To-Warm)</p> <p>FWHM / FWTM 55.0° / 81.0°</p> <p>Efficiency 90 %</p> <p>Peak intensity 1.1 cd/lm</p> <p>LEDs/each optic 1</p> <p>Light colour White</p> <p>Required components: C13868_LENINA-STD-BASE-VERO13-18 Bender Wirth: 490 Typ L1</p>		
<p>LUMINUS</p> <p>LED CTM-14 (Tunable White)</p> <p>FWHM / FWTM 60.0° / 85.0°</p> <p>Efficiency 86 %</p> <p>Peak intensity 1 cd/lm</p> <p>LEDs/each optic 1</p> <p>Light colour White</p> <p>Required components: C13867_LENINA-STD-BASE-VERO29 C12606_LENINA-DL Bender Wirth: 442 Typ L3</p>		

PHOTOMETRIC DATA (MEASURED):

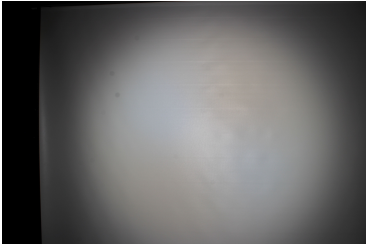
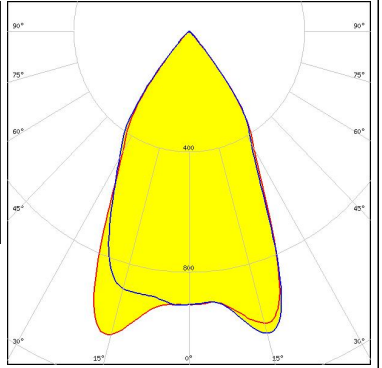
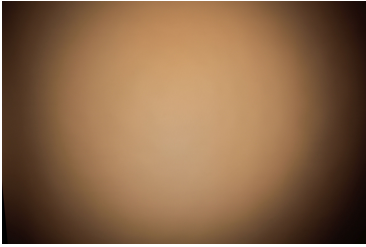
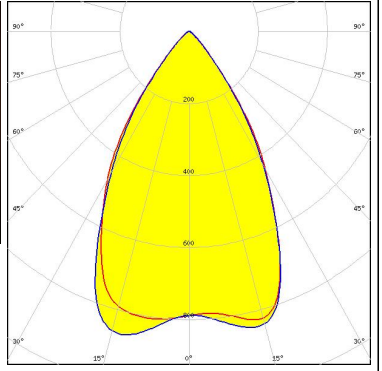
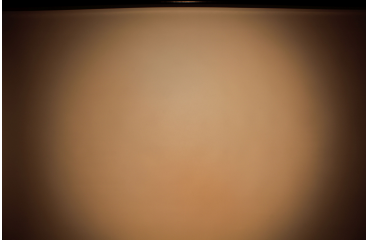
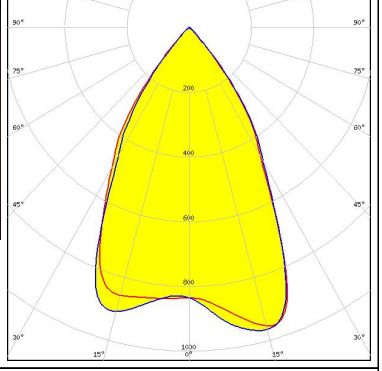
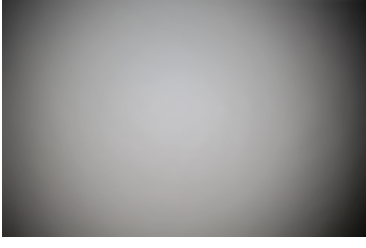
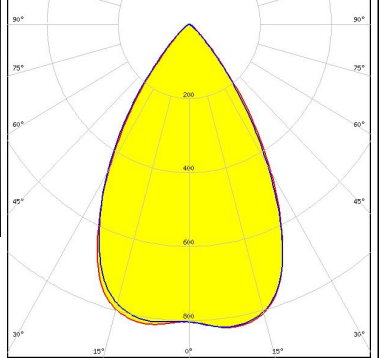
<p>LUMINUS</p> <p>LED CTM-14 (Tunable White)</p> <p>FWHM / FWTM 58.0° / 83.0°</p> <p>Efficiency 91 %</p> <p>Peak intensity 1.1 cd/lm</p> <p>LEDs/each optic 1</p> <p>Light colour White</p> <p>Required components: C13867_LENINA-STD-BASE-VERO29 Bender Wirth: 442 Typ L3</p>		
<p>LUMINUS</p> <p>LED CTM-18 (Tunable White)</p> <p>FWHM / FWTM 63.0° / 87.0°</p> <p>Efficiency 85 %</p> <p>Peak intensity 0.9 cd/lm</p> <p>LEDs/each optic 1</p> <p>Light colour White</p> <p>Required components: C13867_LENINA-STD-BASE-VERO29 C12606_LENINA-DL Bender Wirth: 442 Typ L3</p>		
<p>LUMINUS</p> <p>LED CTM-18 (Tunable White)</p> <p>FWHM / FWTM 32.0° / 76.0°</p> <p>Efficiency 92 %</p> <p>Peak intensity 2 cd/lm</p> <p>LEDs/each optic 1</p> <p>Light colour White</p> <p>Required components: C13867_LENINA-STD-BASE-VERO29 Bender Wirth: 442 Typ L3</p>		
<p>LUMINUS</p> <p>LED CTM-22 (Tunable White)</p> <p>FWHM / FWTM 63.0° / 89.0°</p> <p>Efficiency 85 %</p> <p>Peak intensity 0.8 cd/lm</p> <p>LEDs/each optic 1</p> <p>Light colour White</p> <p>Required components: C13867_LENINA-STD-BASE-VERO29 C12606_LENINA-DL Bender Wirth: 494 Typ L3</p>		

PHOTOMETRIC DATA (MEASURED):

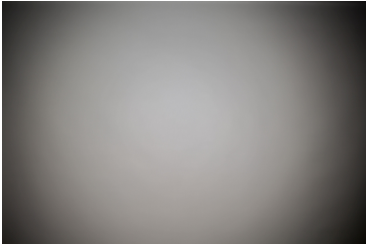
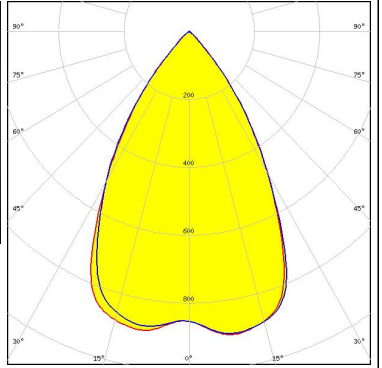
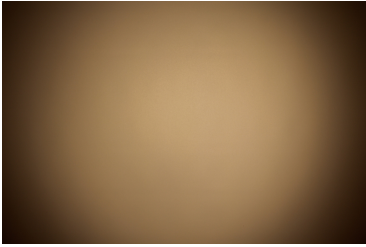
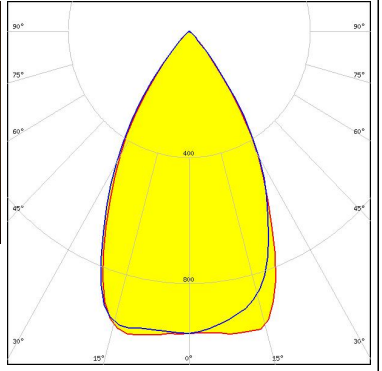
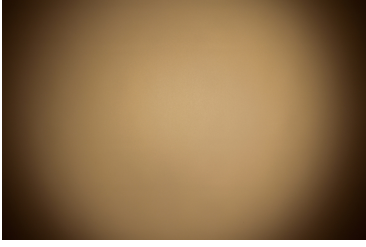
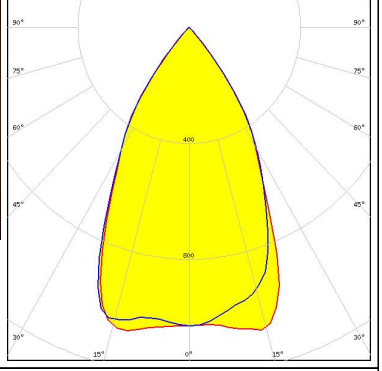
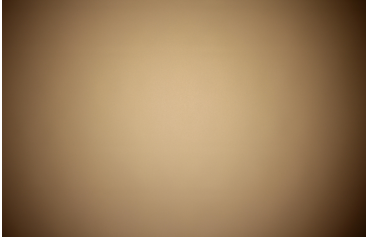
<p>LUMINUS</p> <p>LED CTM-22 (Tunable White)</p> <p>FWHM / FWTM 63.0° / 87.0°</p> <p>Efficiency 90 %</p> <p>Peak intensity 0.9 cd/lm</p> <p>LEDs/each optic 1</p> <p>Light colour White</p> <p>Required components: C13867_LENINA-STD-BASE-VERO29 Bender Wirth: 494 Typ L3</p>		
<p>LUMINUS</p> <p>LED CxM-14 (19x19)</p> <p>FWHM / FWTM 59.0° / 84.0°</p> <p>Efficiency 88 %</p> <p>Peak intensity 1 cd/lm</p> <p>LEDs/each optic 1</p> <p>Light colour White</p> <p>Required components: C12691_LENINA-STD-BASE-CLL030 C12606_LENINA-DL</p>		
<p>LUMINUS</p> <p>LED CxM-14 (19x19)</p> <p>FWHM / FWTM 58.0° / 82.0°</p> <p>Efficiency 92 %</p> <p>Peak intensity 1.1 cd/lm</p> <p>LEDs/each optic 1</p> <p>Light colour White</p> <p>Required components: C12691_LENINA-STD-BASE-CLL030</p>		
<p>LUMINUS</p> <p>LED CxM-22 (28x28)</p> <p>FWHM / FWTM 58.0° / 86.0°</p> <p>Efficiency 87 %</p> <p>Peak intensity 1 cd/lm</p> <p>LEDs/each optic 1</p> <p>Light colour White</p> <p>Required components: C12692_LENINA-STD-BASE-CLL040 C12606_LENINA-DL</p>		

PHOTOMETRIC DATA (MEASURED):



LED CxM-22 (28x28)
 FWHM / FWTM 58.0° / 86.0°
 Efficiency 92 %
 Peak intensity 1.1 cd/lm
 LEDs/each optic 1
 Light colour White
 Required components:
 C12692_LENINA-STD-BASE-CLL040

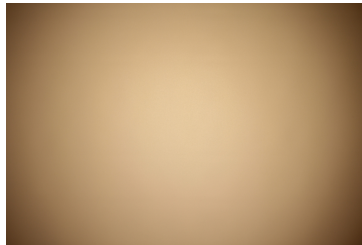

LED COB J-Type
 FWHM / FWTM 59.0° / 84.0°
 Efficiency 82 %
 Peak intensity 0.9 cd/lm
 LEDs/each optic 1
 Light colour White
 Required components:
 C12292_LENINA-STD-BASE-MEZ
 C12606_LENINA-DL

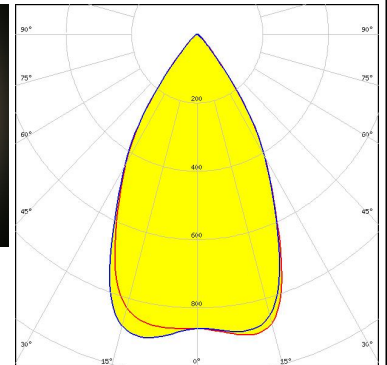
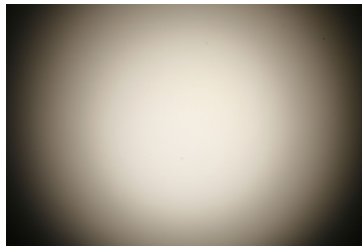

LED COB J-Type
 FWHM / FWTM 58.0° / 82.0°
 Efficiency 86 %
 Peak intensity 1 cd/lm
 LEDs/each optic 1
 Light colour White
 Required components:
 C12292_LENINA-STD-BASE-MEZ

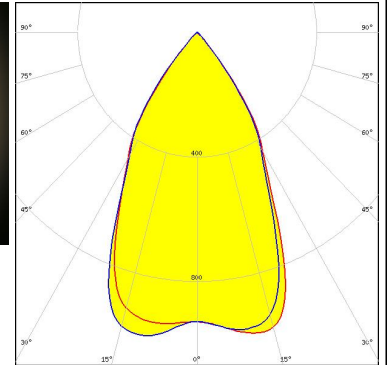
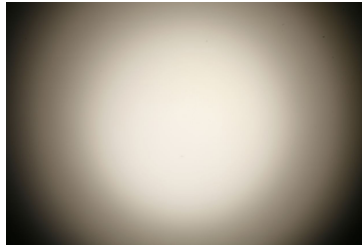

LED COB J-Type
 FWHM / FWTM 59.0° / 84.0°
 Efficiency 87 %
 Peak intensity 1 cd/lm
 LEDs/each optic 1
 Light colour White
 Required components:
 C13868_LENINA-STD-BASE-VERO13-18
 C12606_LENINA-DL
 Bender Wirth: 463 Typ L2

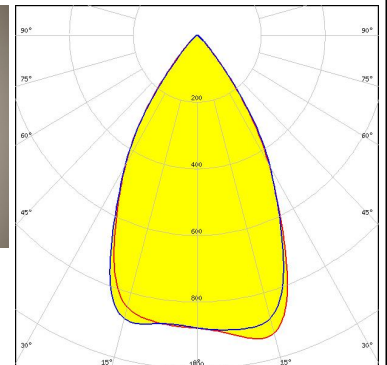
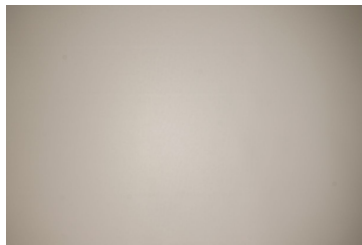

PHOTOMETRIC DATA (MEASURED):

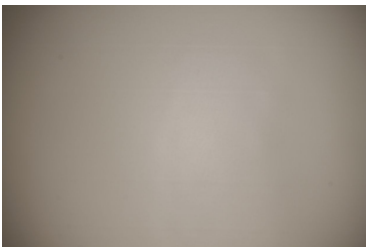
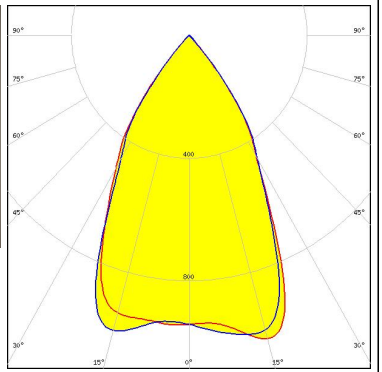
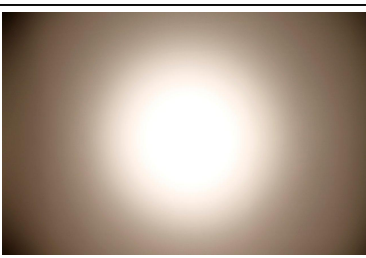
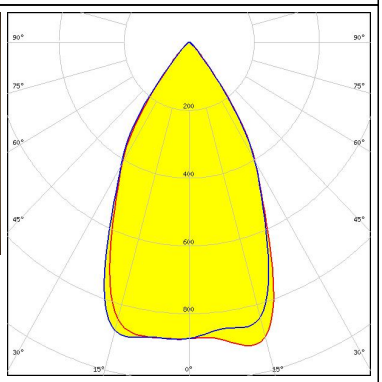
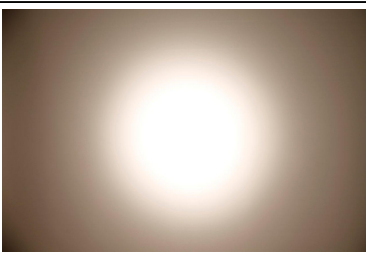
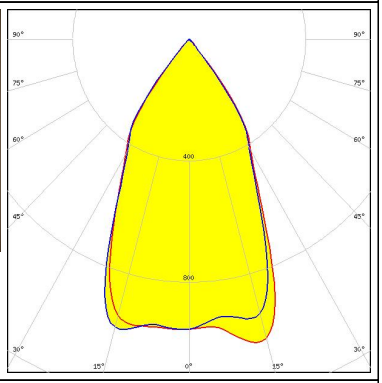
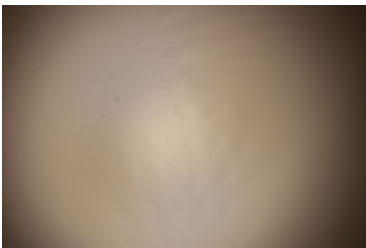
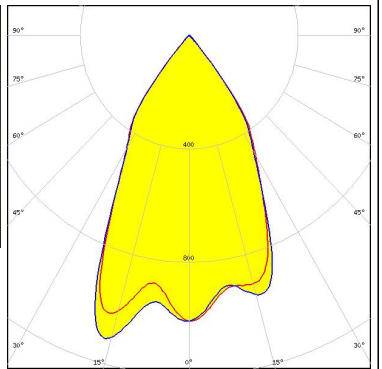
<p>NICHIA</p> <p>LED COB J-Type FWHM / FWTM 59.0° / 83.0° Efficiency 91 % Peak intensity 1.1 cd/lm LEDs/each optic 1 Light colour White</p> <p>Required components: C13868_LENINA-STD-BASE-VERO13-18 Bender Wirth: 463 Typ L2</p>		
<p>NICHIA</p> <p>LED COB L-Type (LES 11) FWHM / FWTM 58.0° / 82.0° Efficiency 80 % Peak intensity 0.9 cd/lm LEDs/each optic 1 Light colour White</p> <p>Required components: C11981_LENINA-STD-BASE-COB-L110 C12606_LENINA-DL</p>		
<p>NICHIA</p> <p>LED COB L-Type (LES 11) FWHM / FWTM 56.0° / 81.0° Efficiency 85 % Peak intensity 1 cd/lm LEDs/each optic 1 Light colour White</p> <p>Required components: C11981_LENINA-STD-BASE-COB-L110</p>		
<p>NICHIA</p> <p>LED NVCWJ024Z-V1MT: COB J-Type Tunable White FWHM / FWTM 56.0° / 81.0° Efficiency 91 % Peak intensity 1.1 cd/lm LEDs/each optic 1 Light colour White</p> <p>Required components: C13868_LENINA-STD-BASE-VERO13-18 Bender Wirth: 498 Typ L2</p>		

PHOTOMETRIC DATA (MEASURED):



LED NVCWJ024Z-V1MT: COB J-Type Tunable White
FWHM / FWTM 60.0° / 84.0°
Efficiency 86 %
Peak intensity 0.9 cd/lm
LEDs/each optic 1
Light colour White
Required components:
 C13868_LENINA-STD-BASE-VERO13-18
 C12606_LENINA-DL
 Bender Wirth: 498 Typ L2

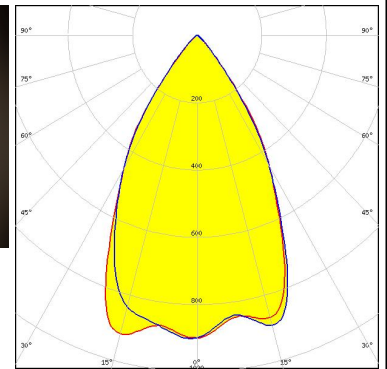
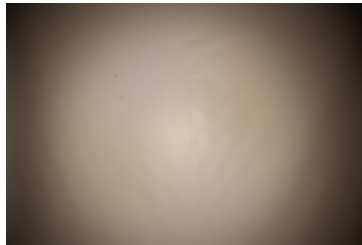

LED Soleriq S13
FWHM / FWTM 59.0° / 83.0°
Efficiency 86 %
Peak intensity 0.9 cd/lm
LEDs/each optic 1
Light colour White
Required components:
 C13868_LENINA-STD-BASE-VERO13-18
 C12606_LENINA-DL
 Bender Wirth: 437 Typ L1

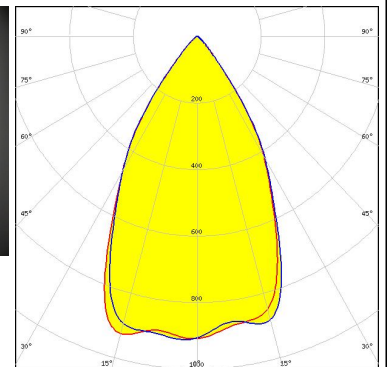
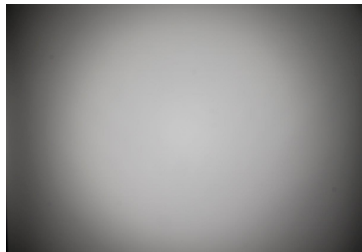

LED Soleriq S13
FWHM / FWTM 56.0° / 81.0°
Efficiency 90 %
Peak intensity 1.1 cd/lm
LEDs/each optic 1
Light colour White
Required components:
 C13868_LENINA-STD-BASE-VERO13-18
 Bender Wirth: 437 Typ L1

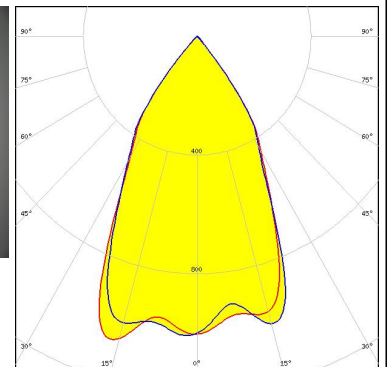
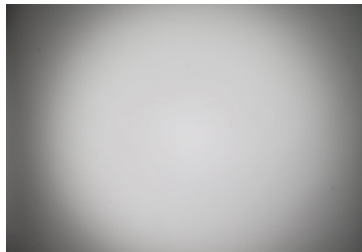

LED Soleriq S19
FWHM / FWTM 60.0° / 85.0°
Efficiency 87 %
Peak intensity 0.9 cd/lm
LEDs/each optic 1
Light colour White
Required components:
 C13867_LENINA-STD-BASE-VERO29
 C12606_LENINA-DL
 Bender Wirth: 462 Typ L3

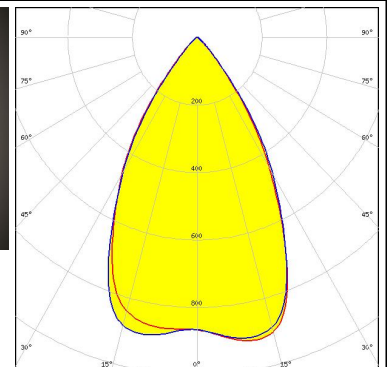
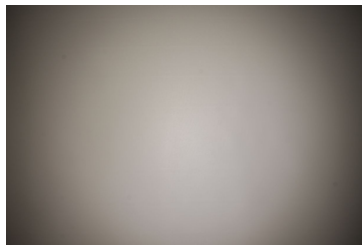

PHOTOMETRIC DATA (MEASURED):

OSRAM

Opto Semiconductors

LED Soleriq S19
 FWHM / FWTM 60.0° / 84.0°
 Efficiency 92 %
 Peak intensity 1 cd/lm
 LEDs/each optic 1
 Light colour White

Required components:

C13867_LENINA-STD-BASE-VERO29
 Bender Wirth: 462 Typ L3

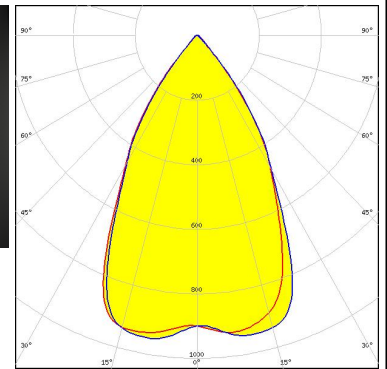
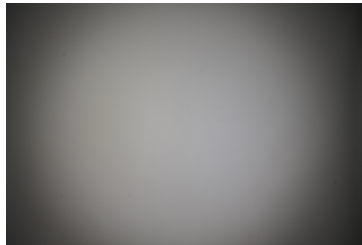

PHILIPS

LED Fortimo SLM L13 CoB
 FWHM / FWTM 57.0° / 83.0°
 Efficiency 85 %
 Peak intensity 1 cd/lm
 LEDs/each optic 1
 Light colour White

Required components:

C12292_LENINA-STD-BASE-MEZ
 C12606_LENINA-DL

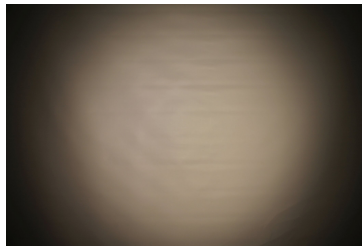

PHILIPS

LED Fortimo SLM L13 CoB
 FWHM / FWTM 57.0° / 81.0°
 Efficiency 92 %
 Peak intensity 1.2 cd/lm
 LEDs/each optic 1
 Light colour White

Required components:

C12292_LENINA-STD-BASE-MEZ

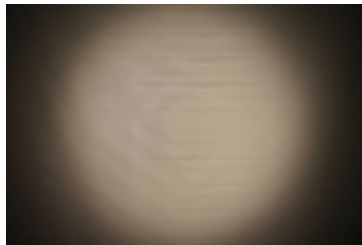

PHILIPS

LED Fortimo SLM L15 CoB
 FWHM / FWTM 56.0° / 83.0°
 Efficiency 85 %
 Peak intensity 1 cd/lm
 LEDs/each optic 1
 Light colour White

Required components:

C12292_LENINA-STD-BASE-MEZ
 C12606_LENINA-DL

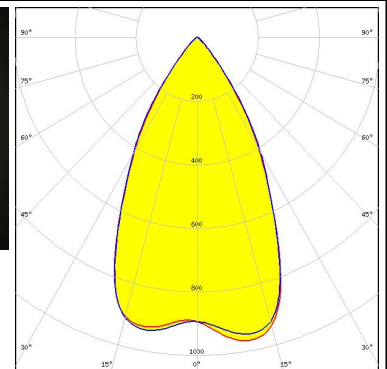
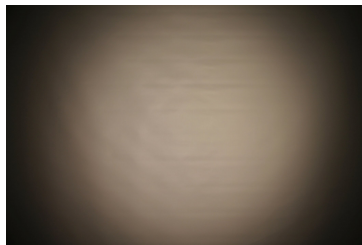

PHOTOMETRIC DATA (MEASURED):

PHILIPS

LED Fortimo SLM L15 CoB
 FWHM / FWTM 59.0° / 82.0°
 Efficiency 91 %
 Peak intensity 1.1 cd/lm
 LEDs/each optic 1
 Light colour White
 Required components:
 C12292_LENINA-STD-BASE-MEZ

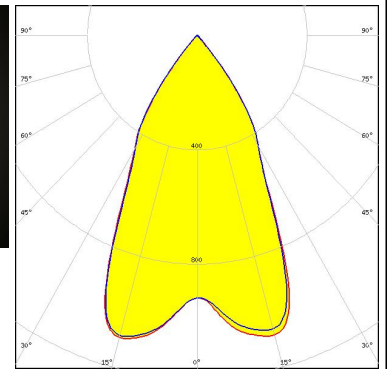

PHILIPS

LED Fortimo SLM L19 CoB
 FWHM / FWTM 53.0° / 81.0°
 Efficiency 91 %
 Peak intensity 1.1 cd/lm
 LEDs/each optic 1
 Light colour White
 Required components:
 C12692_LENINA-STD-BASE-CLL040

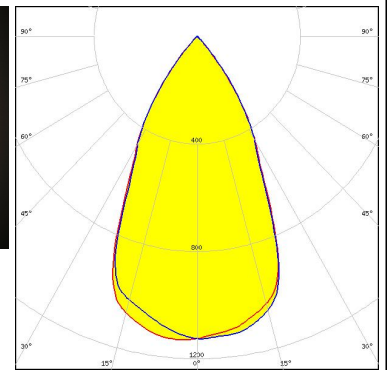
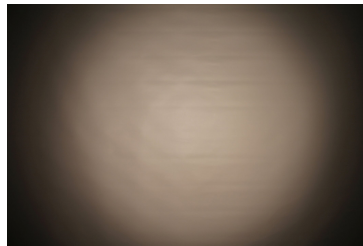

PHILIPS

LED Fortimo SLM L19 CoB
 FWHM / FWTM 54.0° / 83.0°
 Efficiency 86 %
 Peak intensity 1 cd/lm
 LEDs/each optic 1
 Light colour White
 Required components:
 C12692_LENINA-STD-BASE-CLL040
 C12606_LENINA-DL

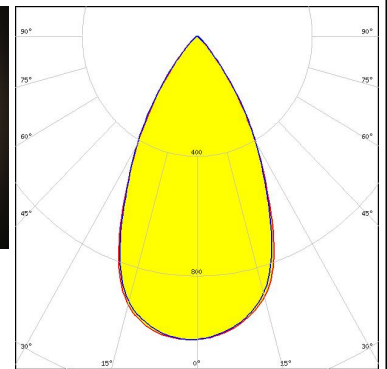
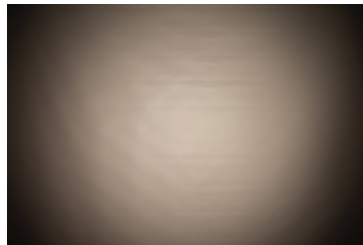

PHILIPS

LED Fortimo SLM L23 CoB
 FWHM / FWTM 39.0° / 76.0°
 Efficiency 92 %
 Peak intensity 1.7 cd/lm
 LEDs/each optic 1
 Light colour White
 Required components:
 C12692_LENINA-STD-BASE-CLL040

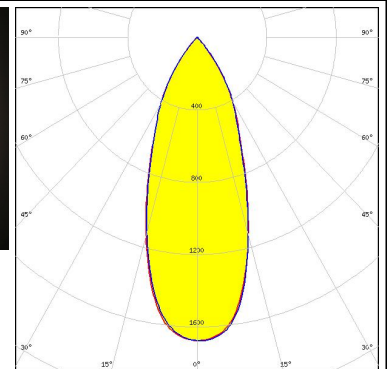
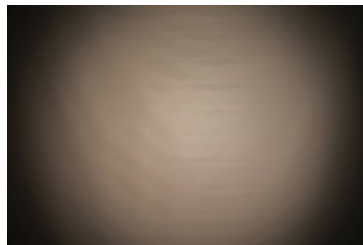

PHOTOMETRIC DATA (MEASURED):

PHILIPS

LED Fortimo SLM L23 CoB
 FWHM / FWTM 57.0° / 84.0°
 Efficiency 85 %
 Peak intensity 1 cd/lm
 LEDs/each optic 1
 Light colour White
 Required components:
 C12292_LENINA-STD-BASE-MEZ
 C12606_LENINA-DL

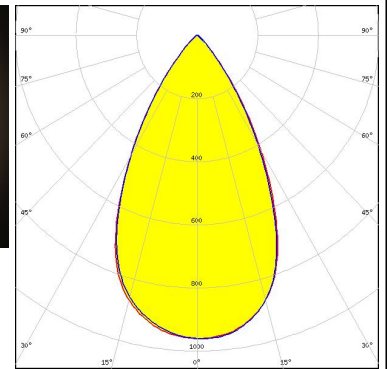

SAMSUNG

LED LC016D / LC019D / LC026D / LC033D
 FWHM / FWTM 57.0° / 82.0°
 Efficiency 91 %
 Peak intensity 1 cd/lm
 LEDs/each optic 1
 Light colour White
 Required components:
 C12691_LENINA-STD-BASE-CLL030

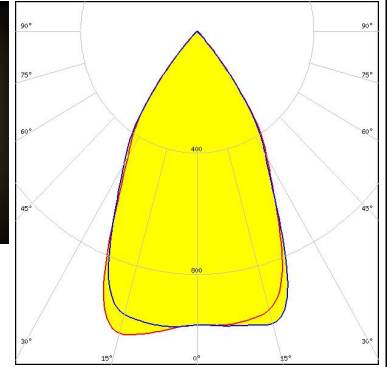

SAMSUNG

LED LC016D / LC019D / LC026D / LC033D
 FWHM / FWTM 59.0° / 84.0°
 Efficiency 87 %
 Peak intensity 1 cd/lm
 LEDs/each optic 1
 Light colour White
 Required components:
 C12691_LENINA-STD-BASE-CLL030
 C12606_LENINA-DL

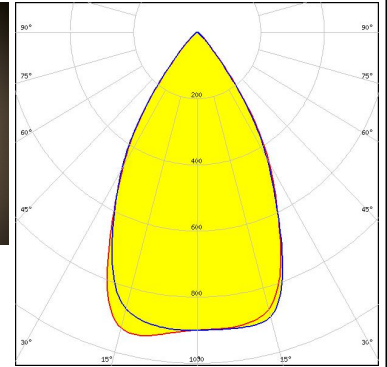
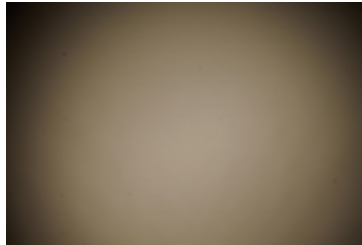

SAMSUNG

LED LC026B / 033B / 040B
 FWHM / FWTM 61.0° / 85.0°
 Efficiency 86 %
 Peak intensity 0.9 cd/lm
 LEDs/each optic 1
 Light colour White
 Required components:
 C13868_LENINA-STD-BASE-VERO13-18
 C12606_LENINA-DL
 Bender Wirth: 450 Typ L2

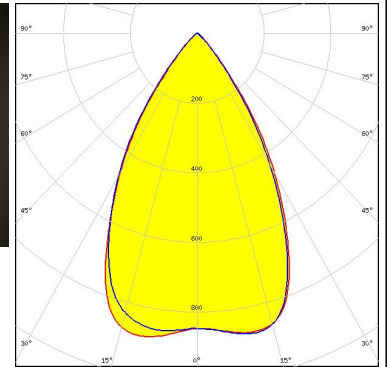
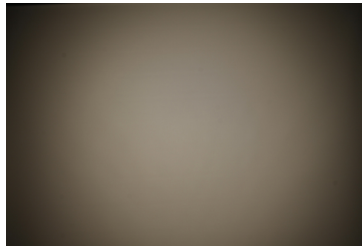

PHOTOMETRIC DATA (MEASURED):

SAMSUNG

LED LC026B / 033B / 040B
 FWHM / FWTM 61.0° / 84.0°
 Efficiency 91 %
 Peak intensity 1 cd/lm
 LEDs/each optic 1
 Light colour White
 Required components:
 C13868_LENINA-STD-BASE-VERO13-18
 Bender Wirth: 450 Typ L2

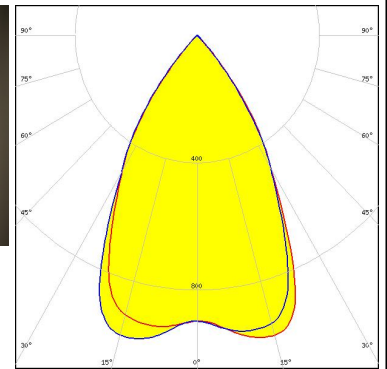
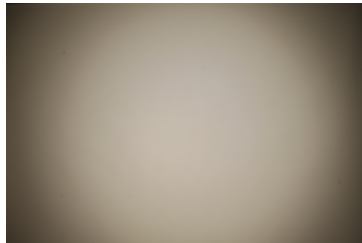

SAMSUNG

LED LC040D / LC060D / LC080D
 FWHM / FWTM 59.0° / 85.0°
 Efficiency 86 %
 Peak intensity 0.9 cd/lm
 LEDs/each optic 1
 Light colour White
 Required components:
 C12692_LENINA-STD-BASE-CLL040
 C12606_LENINA-DL

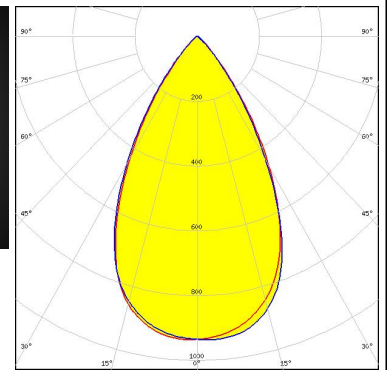
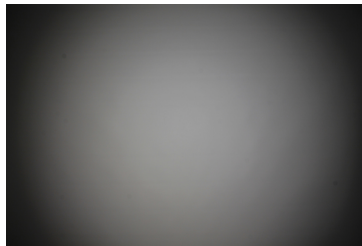

SAMSUNG

LED LC040D / LC060D / LC080D
 FWHM / FWTM 59.0° / 84.0°
 Efficiency 91 %
 Peak intensity 1 cd/lm
 LEDs/each optic 1
 Light colour White
 Required components:
 C12692_LENINA-STD-BASE-CLL040

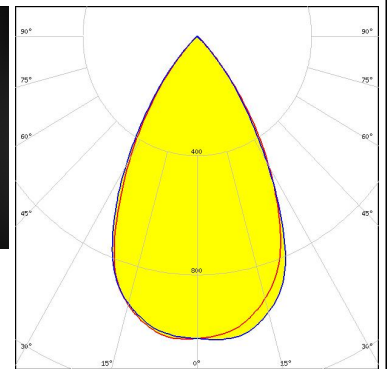
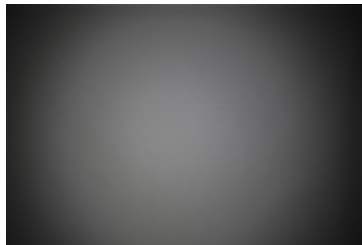





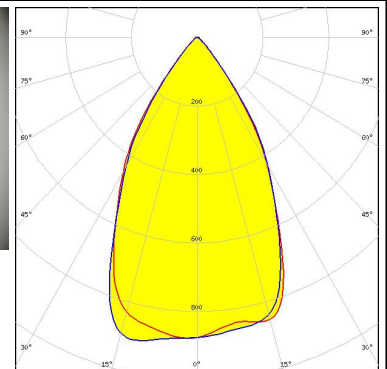

SEOUL SEMICONDUCTOR

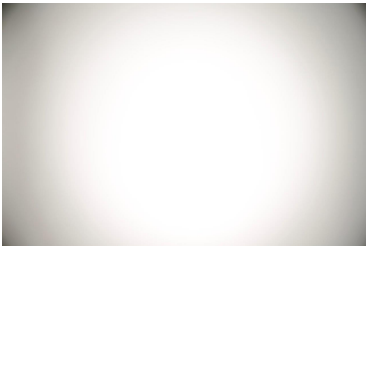
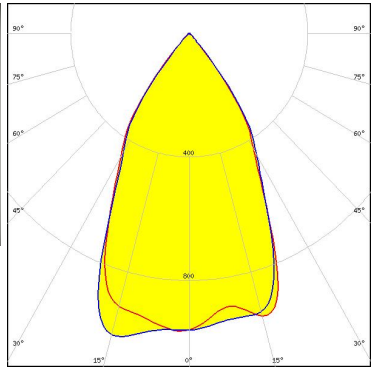
LED ZC12/18
 FWHM / FWTM 59.0° / 84.0°
 Efficiency 84 %
 Peak intensity 0.9 cd/lm
 LEDs/each optic 1
 Light colour White
 Required components:
 C12691_LENINA-STD-BASE-CLL030
 C12606_LENINA-DL

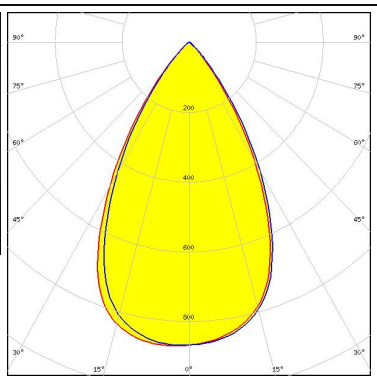

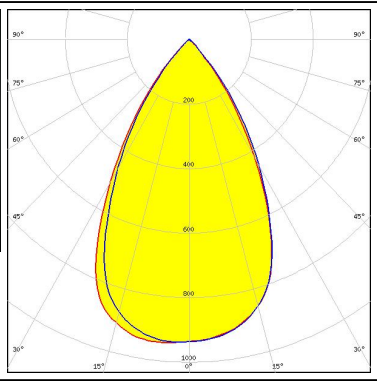
PHOTOMETRIC DATA (MEASURED):

<p>SEOL SEOUL SEMICONDUCTOR</p> <p>LED ZC12/18 FWHM / FWTM 57.0° / 82.0° Efficiency 88 % Peak intensity 1 cd/lm LEDs/each optic 1 Light colour White Required components: C12691_LENINA-STD-BASE-CLL030</p>		
<p>SEOL SEOUL SEMICONDUCTOR</p> <p>LED ZC25/40/60 FWHM / FWTM 60.0° / 86.0° Efficiency 82 % Peak intensity 0.9 cd/lm LEDs/each optic 1 Light colour White Required components: C12692_LENINA-STD-BASE-CLL040 C12606_LENINA-DL</p>		
<p>SEOL SEOUL SEMICONDUCTOR</p> <p>LED ZC25/40/60 FWHM / FWTM 60.0° / 85.0° Efficiency 86 % Peak intensity 0.9 cd/lm LEDs/each optic 1 Light colour White Required components: C12692_LENINA-STD-BASE-CLL040</p>		
<h2>SHARP</h2>		
<p>LED Mega Zenigata (GW5DGC) FWHM / FWTM 45.0° / 80.0° Efficiency 78 % LEDs/each optic 1 Light colour White Required components: C12292_LENINA-STD-BASE-MEZ C12606_LENINA-DL</p>		

PHOTOMETRIC DATA (MEASURED):

SHARP

LED Mega Zenigata (GW5DGC)
FWHM / FWTM 41.0° / 77.0°
Efficiency 86 %
LEDs/each optic 1
Light colour White
Required components:
C12292_LENINA-STD-BASE-MEZ

SHARP

LED Mega Zenigata (GW6DME)
FWHM / FWTM 57.0° / 82.0°
Efficiency 87 %
Peak intensity 1.1 cd/lm
LEDs/each optic 1
Light colour White
Required components:
C12292_LENINA-STD-BASE-MEZ

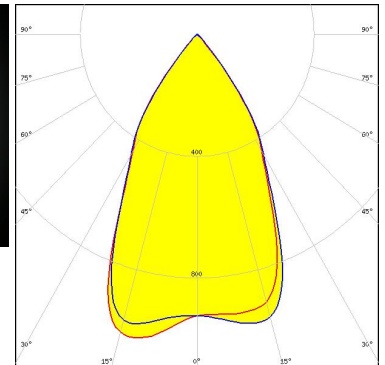
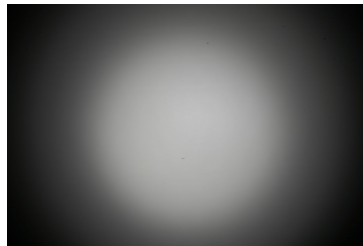

SHARP

LED Mega Zenigata (GW6DME)
FWHM / FWTM 59.0° / 83.0°
Efficiency 83 %
Peak intensity 0.9 cd/lm
LEDs/each optic 1
Light colour White
Required components:
C12292_LENINA-STD-BASE-MEZ
C12606_LENINA-DL

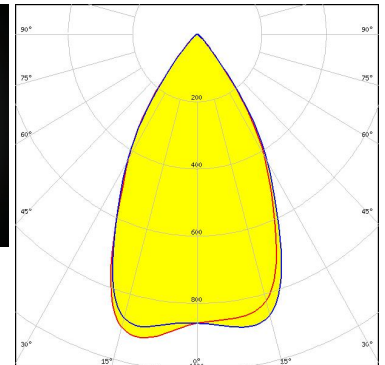
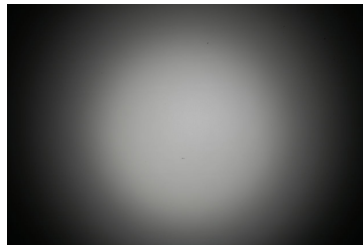

TRIDONIC

LED SLE G7 LES15
FWHM / FWTM 59.0° / 82.0°
Efficiency 92 %
Peak intensity 1.1 cd/lm
LEDs/each optic 1
Light colour White
Required components:
C12691_LENINA-STD-BASE-CLL030

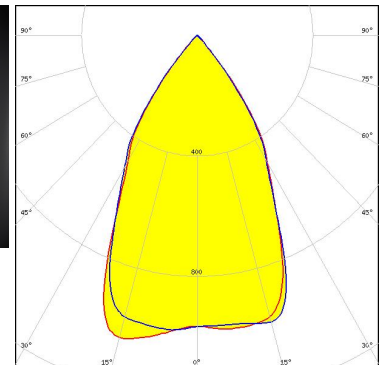
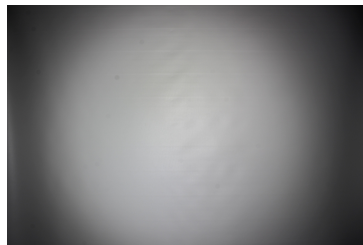

PHOTOMETRIC DATA (MEASURED):

TRIDONIC

LED SLE G7 LES17 H
FWHM / FWTM 56.0° / 82.0°
Efficiency 90 %
Peak intensity 1 cd/lm
LEDs/each optic 1
Light colour White
Required components:
C14547_LENINA-ADAPTER-B

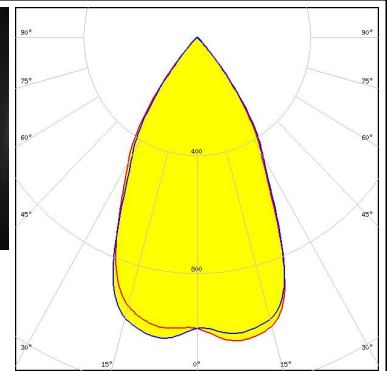
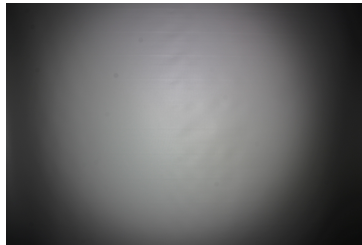





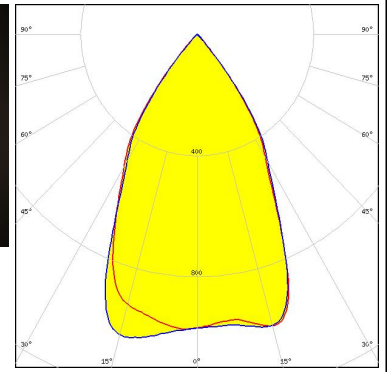
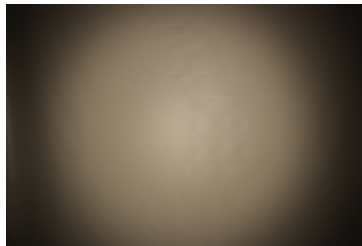

XICATO

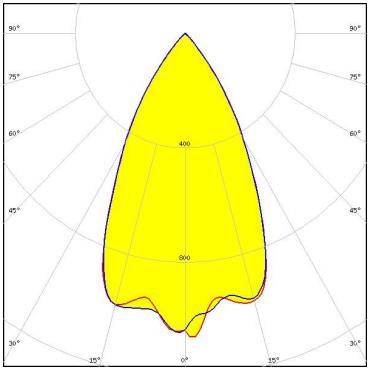
LED XOB 14.5 mm
FWHM / FWTM 58.0° / 82.0°
Efficiency 91 %
Peak intensity 1 cd/lm
LEDs/each optic 1
Light colour White
Required components:
C12691_LENINA-STD-BASE-CLL030

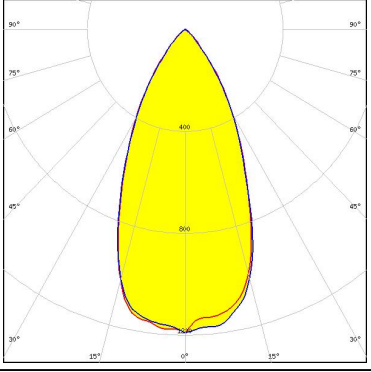

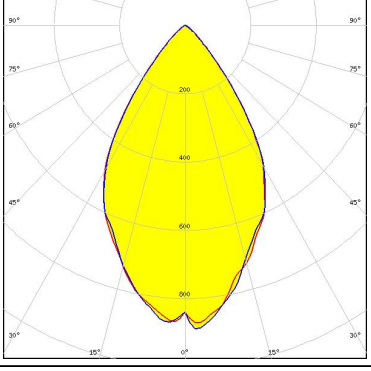
PHOTOMETRIC DATA (SIMULATED):

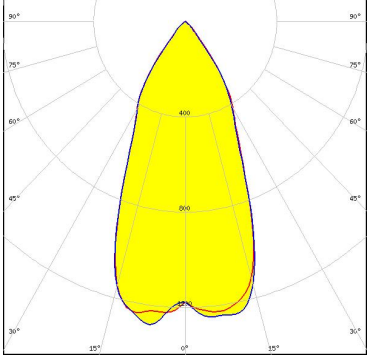
<p></p> <p>LED V10 Gen7 FWHM / FWTM 55.0° / 81.0° Efficiency 85 % Peak intensity 1.1 cd/lm LEDs/each optic 1 Light colour White</p> <p>Required components: C13868_LENINA-STD-BASE-VERO13-18 C12606_LENINA-DL Bender Wirth: 486 Typ L1</p>	
<p></p> <p>LED V13 Gen7 FWHM / FWTM 48.0° / 82.0° Efficiency 88 % Peak intensity 1.2 cd/lm LEDs/each optic 1 Light colour White</p> <p>Required components: C12606_LENINA-DL IDEAL: 50-2103CT + 50-2100AN</p>	
<p></p> <p>LED V13 Gen7 FWHM / FWTM 63.0° / 91.0° Efficiency 87 % Peak intensity 0.9 cd/lm LEDs/each optic 1 Light colour White</p> <p>Required components: C13868_LENINA-STD-BASE-VERO13-18 C12606_LENINA-DL Bender Wirth: 477 Typ L1</p>	
<p></p> <p>LED V13 Gen7 FWHM / FWTM 46.0° / 79.0° Efficiency 90 % Peak intensity 1.3 cd/lm LEDs/each optic 1 Light colour White</p> <p>Required components: IDEAL: 50-2103CT + 50-2100AN</p>	

PHOTOMETRIC DATA (SIMULATED):

bridgelux.

LED V13 Gen7
 FWHM / FWTM 50.0° / 79.0°
 Efficiency 90 %
 Peak intensity 1.1 cd/lm
 LEDs/each optic 1
 Light colour White
 Required components:
 C13868_LENASTD-BASE-VERO13-18
 Bender Wirth: 477 Typ L1

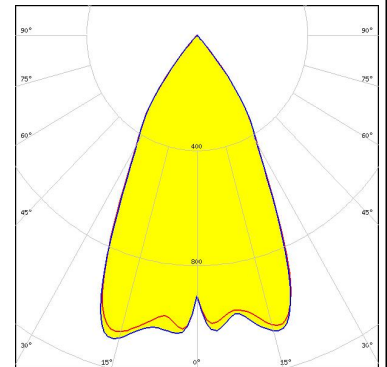

bridgelux.

LED V22 Gen7
 FWHM / FWTM 61.0° / 82.0°
 Efficiency 87 %
 Peak intensity 1 cd/lm
 LEDs/each optic 1
 Light colour White
 Required components:
 C13867_LENASTD-BASE-VERO29
 C12606_LENINA-DL
 Bender Wirth: 431 Typ L3

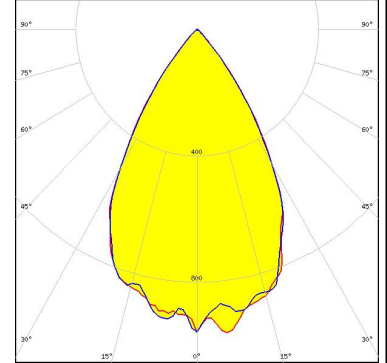

bridgelux.

LED V22 Gen7
 FWHM / FWTM 61.0° / 84.0°
 Efficiency 90 %
 Peak intensity 1 cd/lm
 LEDs/each optic 1
 Light colour White
 Required components:
 C13867_LENASTD-BASE-VERO29
 Bender Wirth: 431 Typ L3

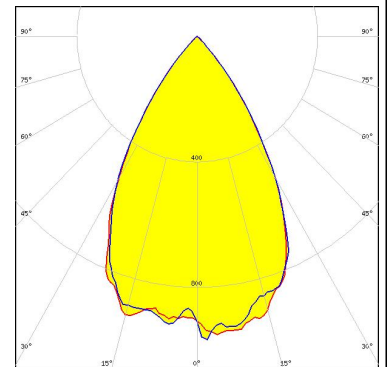

CREE LED

LED CXA/B 30xx
 FWHM / FWTM 49.0° / 81.0°
 Efficiency 84 %
 Peak intensity 1.2 cd/lm
 LEDs/each optic 1
 Light colour White
 Required components:
 C12606_LENINA-DL
 IDEAL: 50-2234C + 50-2100LN

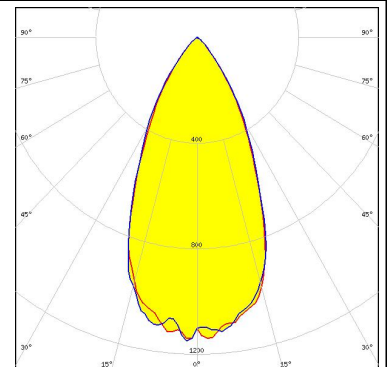

PHOTOMETRIC DATA (SIMULATED):



LED CxA/B 30xx
FWHM / FWTM 46.0° / 80.0°
Efficiency 89 %
Peak intensity 1.3 cd/lm
LEDs/each optic 1
Light colour White
Required components:
IDEAL: 50-2234C + 50-2100LN

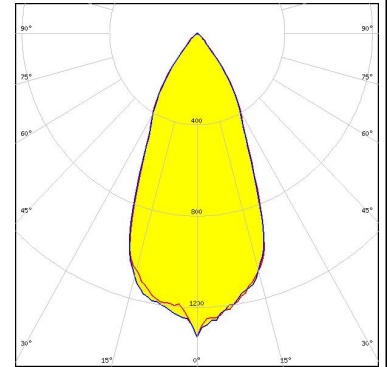

LED CxM-14 (19x19)
FWHM / FWTM 57.0° / 82.0°
Efficiency 90 %
Peak intensity 1 cd/lm
LEDs/each optic 1
Light colour White
Required components:
C13868_LENINA-STD-BASE-VERO13-18
Bender Wirth: 433 Typ L1



LED CxM-14 (19x19)
FWHM / FWTM 60.0° / 83.0°
Efficiency 86 %
Peak intensity 1 cd/lm
LEDs/each optic 1
Light colour White
Required components:
C13868_LENINA-STD-BASE-VERO13-18
C12606_LENINA-DL
Bender Wirth: 433 Typ L1



LED CxM-9 (13.5x13.5)
FWHM / FWTM 54.0° / 80.0°
Efficiency 90 %
Peak intensity 1.1 cd/lm
LEDs/each optic 1
Light colour White
Required components:
C13868_LENINA-STD-BASE-VERO13-18

PHOTOMETRIC DATA (SIMULATED):



LED CxM-9 (13.5x13.5)
 FWHM / FWTM 57.0° / 82.0°
 Efficiency 86 %
 Peak intensity 1 cd/lm
 LEDs/each optic 1
 Light colour White
 Required components:
 C13868_LENINA-STD-BASE-VERO13-18
 C12606_LENINA-DL
 Bender Wirth: 434 Typ L1



LED Soleriq S15
 FWHM / FWTM 56.0° / 81.0°
 Efficiency 90 %
 Peak intensity 1.1 cd/lm
 LEDs/each optic 1
 Light colour White
 Required components:
 C12691_LENINA-STD-BASE-CLL030

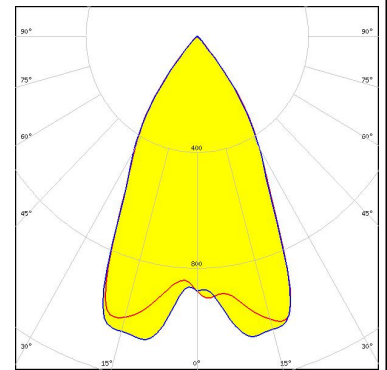

LED ZC12/18
 FWHM / FWTM 57.0° / 82.0°
 Efficiency 90 %
 Peak intensity 1 cd/lm
 LEDs/each optic 1
 Light colour White
 Required components:
 C13868_LENINA-STD-BASE-VERO13-18
 Bender Wirth: 433 Typ L1



LED ZC12/18
 FWHM / FWTM 60.0° / 83.0°
 Efficiency 86 %
 Peak intensity 1 cd/lm
 LEDs/each optic 1
 Light colour White
 Required components:
 C13868_LENINA-STD-BASE-VERO13-18
 C12606_LENINA-DL
 Bender Wirth: 433 Typ L1

PHOTOMETRIC DATA (SIMULATED):

	
SEOL SEMICONDUCTOR	
LED	ZC4/6
FWHM / FWTM	54.0° / 80.0°
Efficiency	90 %
Peak intensity	1.1 cd/lm
LEDs/each optic	1
Light colour	White
Required components:	
C13868_LENINA-STD-BASE-VERO13-18	
Bender Wirth: 434 Typ L1	
<hr/>	
	
SEOL SEMICONDUCTOR	
LED	ZC4/6
FWHM / FWTM	57.0° / 82.0°
Efficiency	86 %
Peak intensity	1 cd/lm
LEDs/each optic	1
Light colour	White
Required components:	
C13868_LENINA-STD-BASE-VERO13-18	
C12606_LENINA-DL	
Bender Wirth: 434 Typ L1	

GENERAL INFORMATION:

NOTE: The typical beam angle will be changed by different color, chip size and chip position tolerance. The typical total beam angle is the full angle measured where the luminous intensity is half of the peak value.

Due to use of high power COB's with this product, special attention to proper thermal design is highly recommended. LEDiL has no liability for direct, indirect or consecutive damages arising from the LEDiL products being used outside of the recommended temperature range.

MATERIALS:

As part of our continuous research and improvement processes, and to ensure the best possible quality and availability of our products, LEDiL reserves the right to change material grades without notice.

PRODUCT DATA USER AGREEMENT AND DISCLAIMER:

The measured data in the provided downloadable LEDiL Product Datasheets and Mechanical 2D-Drawings is rounded and provided as reference for planning. LEDiL Oy's optical specifications have been verified by conducting performance testing of the products in accordance with the company's quality system. The reported data are averaged results of multiple measurements with typical variation. LEDiL Oy reserves the right to without prior notification make changes and improvements to its products.

LEDiL Oy assumes neither warranty, nor guarantee nor any other liability of any kind for the contents and correctness of the provided data. The provided data has been generated with highest diligence but the provided data may in reality not represent the complete possible variation range of all intrinsic parameters. Therefore, in certain cases a deviation from the provided data could occur.

LEDiL Oy reserves the right to undertake technical changes of its products without further notification which could lead to changes in the provided data. LEDiL Oy assumes no liability of any kind for the possible deviation from any provided data or any other damage resulting from the usage of the provided data.

The user agrees to this disclaimer and user agreement with the download or usage of the provided files.

LEDiL Oy

Joensuunkatu 13
FI-24240 SALO
Finland

LEDiL Inc.

228 West Page Street
Suite D
Sycamore IL 60178
USA

Ledil Optics Technology (Shenzhen) Co., Ltd.

405 , Block B
Casic Motor Building
Shenzhen 518057
P.R.CHINA

Local sales and technical support

[www.ledil.com/
where_to_buy](http://www.ledil.com/where_to_buy)

Shipping locations

Salo, Finland
Hong Kong, China

Distribution Partners

[www.ledil.com/
where_to_buy](http://www.ledil.com/where_to_buy)

X-ON Electronics

Largest Supplier of Electrical and Electronic Components

Click to view similar products for [LED Lighting Reflectors](#) category:

Click to view products by [Ledil](#) manufacturer:

Other Similar products are found below :

[LL04CR-CFN35155L02](#) [LL04CR-CFN60155L02](#) [LL04CR-CGM85135L02](#) [F13185_GERI-RZ](#) [10604](#) [LL01SP-ATH15R49](#) [10170](#) [12527](#)
[12531](#) [12568](#) [C13253_TINA2-R-CLIP16](#) [CA14591_BROOKE-XW](#) [F15560_MIRELLA-G2-W](#) [CA11525_LAURA-R-W](#) [12796](#) [LMH020-](#)
[REFL-0000-0000062](#) [LMH020-REFL-0000-0000082](#) [C12606_LENINA-DL](#) [CN12711_LENINA-W-DL](#) [C11394_TYRA-S](#) [C11396_TYRA-](#)
[W](#) [C11508_BROOKE-W](#) [C11552_BARBARA-S](#) [C11553_BARBARA-W](#) [C11862_MINNIE-W](#) [C11979_LENA-S](#) [C11980_LENA-W](#)
[C11996_LENA-LENS](#) [C12083_BROOKE-SCR-M](#) [C12095_MINNIE-M](#) [C12097_MINNIE-WWW](#) [C12154_LENA-M](#) [C12469_LISA2-R-](#)
[PIN](#) [C12476_MIRELLA-50-S](#) [C12477_MIRELLA-50-M](#) [C12480_MIRELLA-50-S-PIN](#) [C12516_RITA-WAS](#) [C12597_LENINA-S](#)
[C12599_LENINA-W](#) [C12948_LENA-WAS](#) [C12958_LENINA-XW](#) [C13085_MIRELLA-50-S-PF](#) [C13087_MIRELLA-50-W-PF](#)
[C13101_LENA-X-WAS](#) [C13555_BRIDGET-W-UNI](#) [C13556_BRIDGET-M-UNI](#) [C13557_BRIDGET-S-UNI](#) [C14346_ANGELETTE-WAS](#)
[C17099_ALISE-50-DL](#) [C17095_ALISE-70-CL](#)