

LENA-SS

~18° smooth spot beam

TECHNICAL SPECIFICATIONS:

Dimensions	Ø 111.0 mm
Height	80 mm
Fastening	socket
ROHS compliant	yes ⓘ

MATERIAL SPECIFICATIONS:

Component	Type	Material
LENA-SS	Reflector	PC

ORDERING INFORMATION:

Component
C13117_LENA-SS
» Box size: 400 x 280 x 380 mm







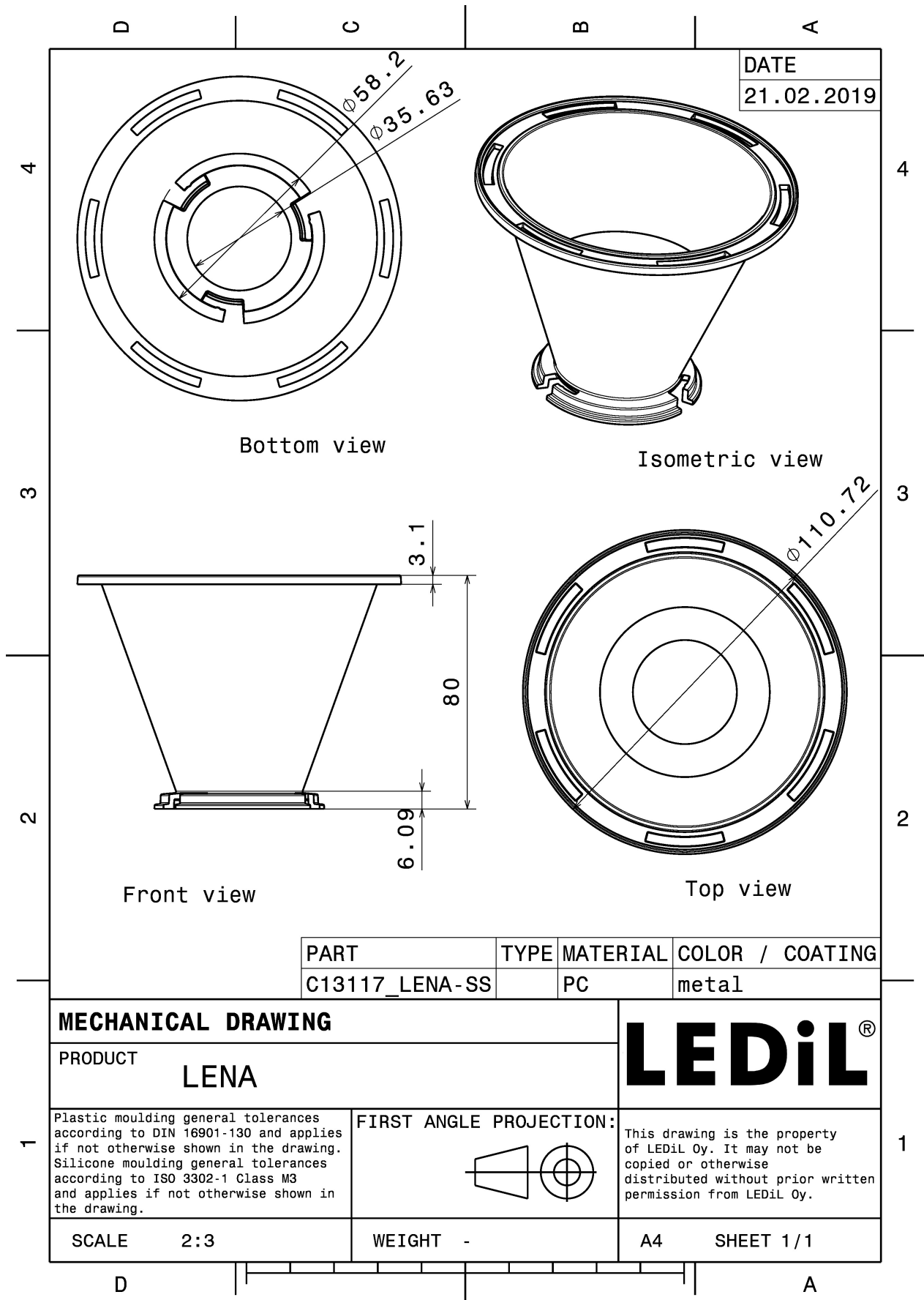



Colour	Finish	Coating
metal		lacquer

Qty in box	MOQ	MPQ	Box weight (kg)
60	60	60	4.1

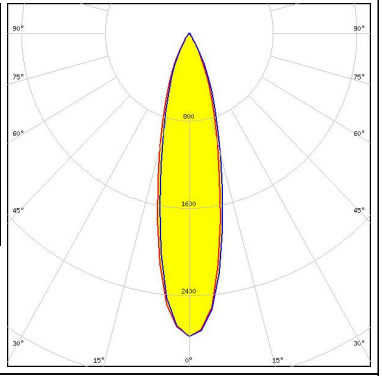

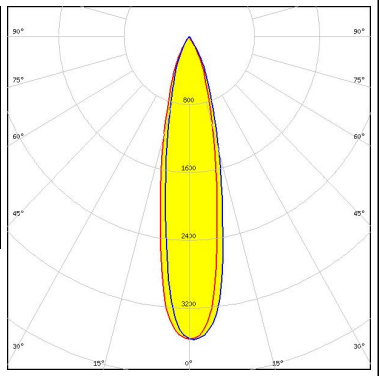

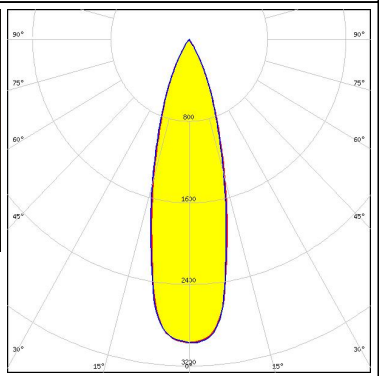

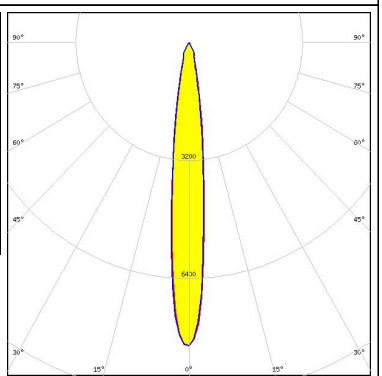



See also our general installation guide: www.ledil.com/installation_guide

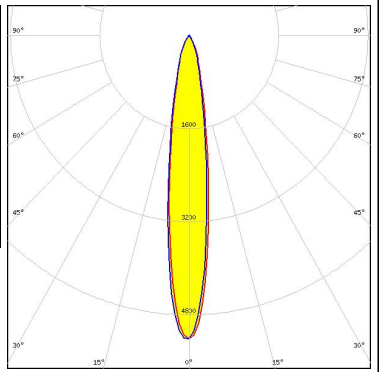

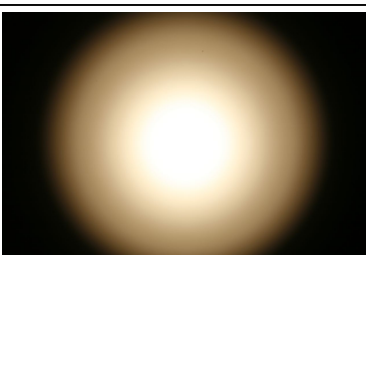
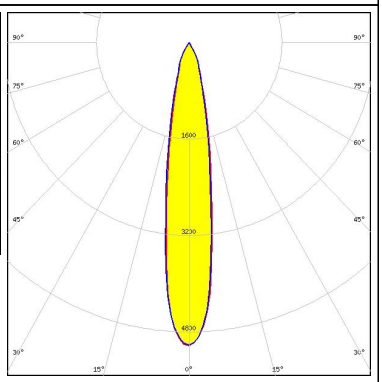

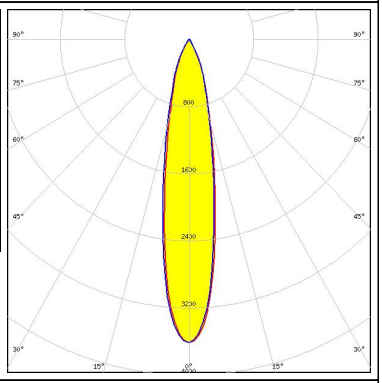

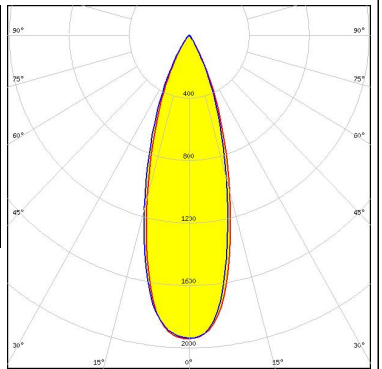

PHOTOMETRIC DATA (MEASURED):

<p></p> <p>LED BXRA RS FWHM / FWTM 25.0° / 54.0° Efficiency 76 % Peak intensity 2.8 cd/lm LEDs/each optic 1 Light colour White</p> <p>Required components: C12229_LENA-STD-BASE-RS C11996_LENA-LENS</p>		
<p></p> <p>LED BXRA RS FWHM / FWTM 22.0° / 52.0° Efficiency 83 % Peak intensity 3.6 cd/lm LEDs/each optic 1 Light colour White</p> <p>Required components: C12229_LENA-STD-BASE-RS</p>		
<p></p> <p>LED Vero SE 29 FWHM / FWTM 29.0° / 56.0° Efficiency 89 % Peak intensity 3 cd/lm LEDs/each optic 1 Light colour White</p> <p>Required components: C15083_LENA-STD-BASE-VERO29</p>		
<p></p> <p>LED VERO13 FWHM / FWTM 13.0° / 30.0° Efficiency 82 % Peak intensity 8.3 cd/lm LEDs/each optic 1 Light colour White</p> <p>Required components: C13868_LENA-STD-BASE-VERO13-18</p>		

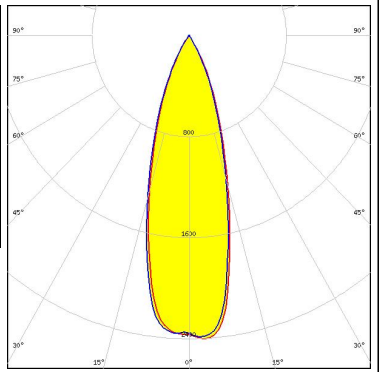
PHOTOMETRIC DATA (MEASURED):

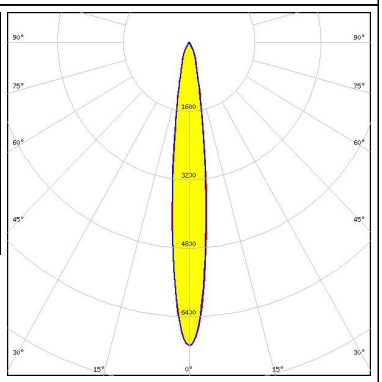
<p></p> <p>LED VERO13 FWHM / FWTM 15.0° / 38.0° Efficiency 76 % Peak intensity 5.3 cd/lm LEDs/each optic 1 Light colour White</p> <p>Required components: C13868_LENA-STD-BASE-VERO13-18 C11996_LENA-LENS</p>		
<p></p> <p>LED VERO18 FWHM / FWTM 18.0° / 42.0° Efficiency 82 % Peak intensity 5 cd/lm LEDs/each optic 1 Light colour White</p> <p>Required components: C13868_LENA-STD-BASE-VERO13-18</p>		
<p></p> <p>LED VERO18 FWHM / FWTM 20.0° / 49.0° Efficiency 76 % Peak intensity 3.6 cd/lm LEDs/each optic 1 Light colour White</p> <p>Required components: C13868_LENA-STD-BASE-VERO13-18 C11996_LENA-LENS</p>		
<p></p> <p>LED VERO29 FWHM / FWTM 32.0° / 60.0° Efficiency 74 % Peak intensity 1.9 cd/lm LEDs/each optic 1 Light colour White</p> <p>Required components: C13867_LENA-STD-BASE-VERO29 C11996_LENA-LENS</p>		

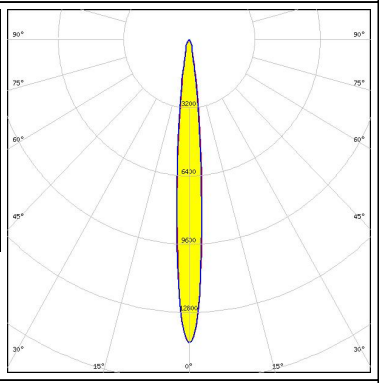
PHOTOMETRIC DATA (MEASURED):

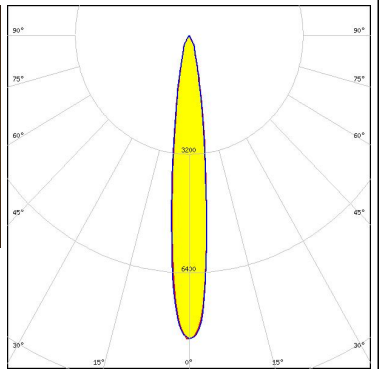
<p></p> <p>LED VERO29 FWHM / FWTM 31.0° / 57.0° Efficiency 80 % Peak intensity 2.4 cd/lm LEDs/each optic 1 Light colour White Required components: C13867_LENA-STD-BASE-VERO29</p>		
<p>CITIZEN</p> <p>LED CLL02x/CLU02x (LES10) FWHM / FWTM 13.0° / 32.0° Efficiency 82 % Peak intensity 7.1 cd/lm LEDs/each optic 1 Light colour White Required components: C13868_LENA-STD-BASE-VERO13-18 C11996_LENA-LENS Bender Wirth: 434 Typ L1</p>		
<p>CITIZEN</p> <p>LED CLL02x/CLU02x (LES10) FWHM / FWTM 10.0° / 22.0° Efficiency 87 % Peak intensity 14.2 cd/lm LEDs/each optic 1 Light colour White Required components: C13868_LENA-STD-BASE-VERO13-18 Bender Wirth: 434 Typ L1</p>		
<p>CITIZEN</p> <p>LED CLL03x/CLU03x FWHM / FWTM 13.0° / 31.0° Efficiency 85 % Peak intensity 8.2 cd/lm LEDs/each optic 1 Light colour White Required components: A.A.G. STUCCHI: 8101-G2 + S-8000-11</p>		

PHOTOMETRIC DATA (MEASURED):

CITIZEN

LED CLL03x/CLU03x
 FWHM / FWTM 17.0° / 41.0°
 Efficiency 82 %
 Peak intensity 5.2 cd/lm
 LEDs/each optic 1
 Light colour White
 Required components:
 C13868_LENA-STD-BASE-VERO13-18
 C11996_LENA-LENS
 Bender Wirth: 433 Typ L1

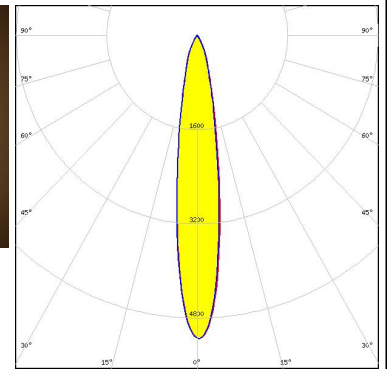
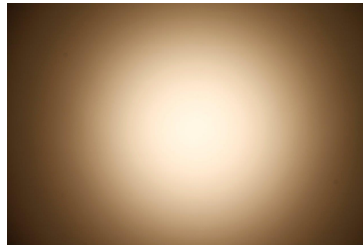

CITIZEN

LED CLL03x/CLU03x
 FWHM / FWTM 14.0° / 31.0°
 Efficiency 87 %
 Peak intensity 8.6 cd/lm
 LEDs/each optic 1
 Light colour White
 Required components:
 C13868_LENA-STD-BASE-VERO13-18
 Bender Wirth: 433 Typ L1

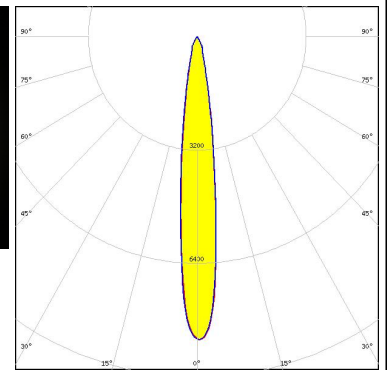

CITIZEN

LED CLL04x/CLU04x
 FWHM / FWTM 20.0° / 51.0°
 Efficiency 80 %
 Peak intensity 3.8 cd/lm
 LEDs/each optic 1
 Light colour White
 Required components:
 IDEAL: 50-2204CT + 50-2100LN

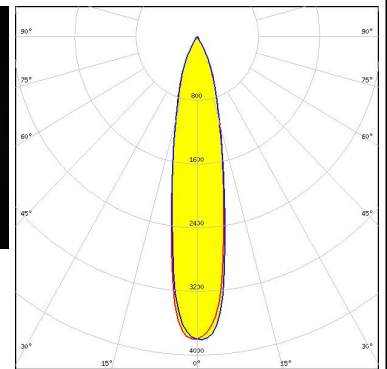

CITIZEN

LED CLL04x/CLU04x
 FWHM / FWTM 24.0° / 53.0°
 Efficiency 77 %
 Peak intensity 3 cd/lm
 LEDs/each optic 1
 Light colour White
 Required components:
 C12692_LENA-STD-BASE-CLL040
 C11996_LENA-LENS

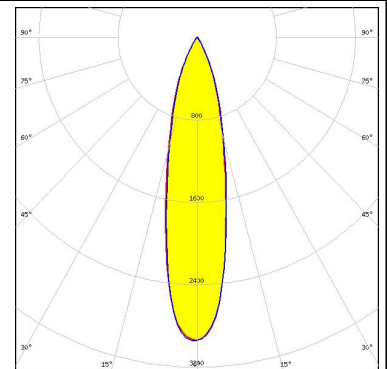

PHOTOMETRIC DATA (MEASURED):

CITIZEN

LED CLL04x/CLU04x
 FWHM / FWTM 23.0° / 54.0°
 Efficiency 82 %
 Peak intensity 3.1 cd/lm
 LEDs/each optic 1
 Light colour White
 Required components:
 C13867_LENA-STD-BASE-VERO29
 C11996_LENA-LENS
 Bender Wirth: 431 Typ L3

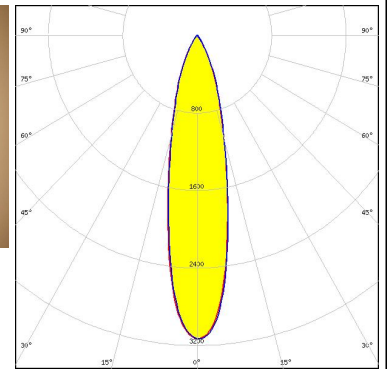
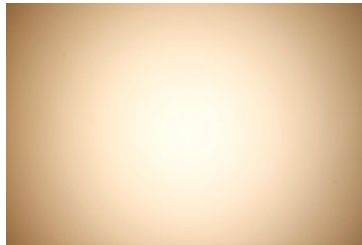

CITIZEN

LED CLL04x/CLU04x
 FWHM / FWTM 22.0° / 51.0°
 Efficiency 82 %
 Peak intensity 3.9 cd/lm
 LEDs/each optic 1
 Light colour White
 Required components:
 C12692_LENA-STD-BASE-CLL040

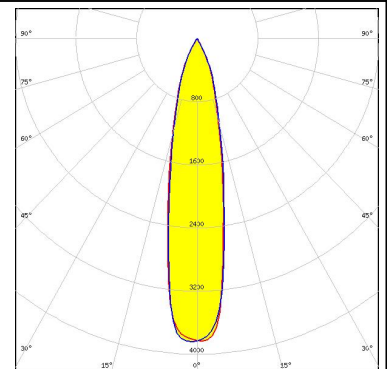

CITIZEN

LED CLL04x/CLU04x
 FWHM / FWTM 20.0° / 48.0°
 Efficiency 87 %
 Peak intensity 4.5 cd/lm
 LEDs/each optic 1
 Light colour White
 Required components:
 C13867_LENA-STD-BASE-VERO29
 Bender Wirth: 431 Typ L3

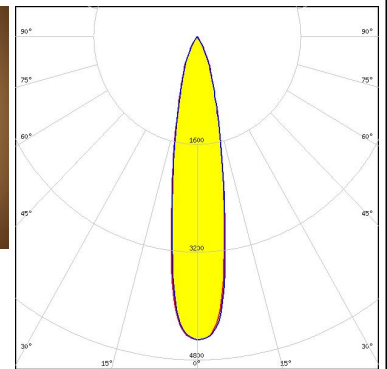
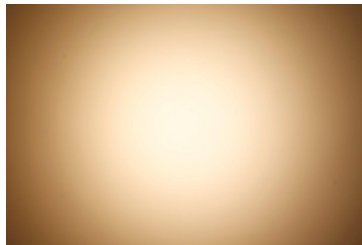

CITIZEN

LED CLL04x/CLU04x
 FWHM / FWTM 20.0° / 48.0°
 Efficiency 79 %
 Peak intensity 4.2 cd/lm
 LEDs/each optic 1
 Light colour White
 Required components:
 A.A.G. STUCCHI: 8102-G2 + S-8000-12

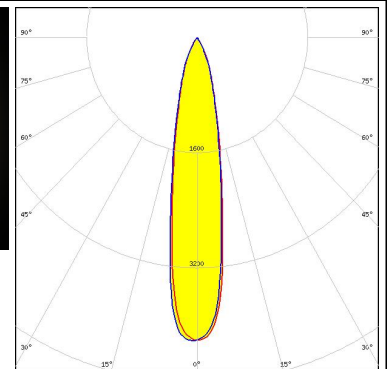
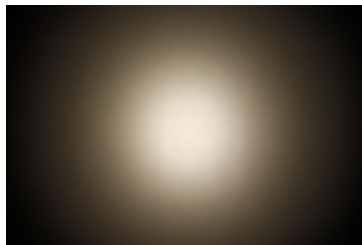

PHOTOMETRIC DATA (MEASURED):

CITIZEN

LED CLU700/701/702
 FWHM / FWTM 11.0° / 27.0°
 Efficiency 82 %
 Peak intensity 8.9 cd/lm
 LEDs/each optic 1
 Light colour White
 Required components:
 C13868_LENA-STD-BASE-VERO13-18
 C11996_LENA-LENS
 Bender Wirth: 434 Typ L1

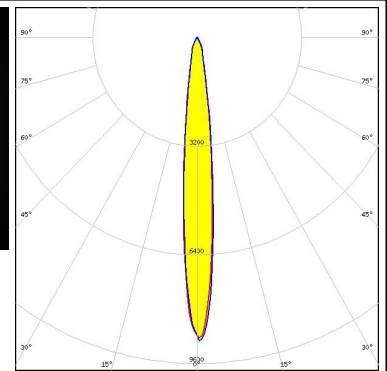

CITIZEN

LED CLU700/701/702
 FWHM / FWTM 7.0° / 18.0°
 Efficiency 87 %
 Peak intensity 21.8 cd/lm
 LEDs/each optic 1
 Light colour White
 Required components:
 C13868_LENA-STD-BASE-VERO13-18
 Bender Wirth: 434 Typ L1

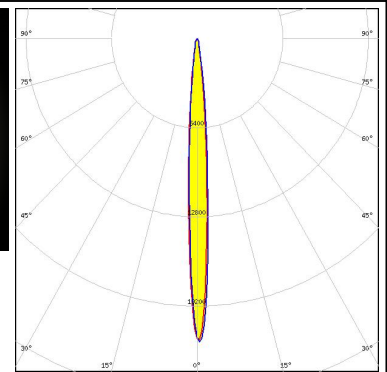

CITIZEN

LED CLU730/731
 FWHM / FWTM 13.0° / 31.0°
 Efficiency 78 %
 Peak intensity 7.1 cd/lm
 LEDs/each optic 1
 Light colour White
 Required components:
 C12692_LENA-STD-BASE-CLL040

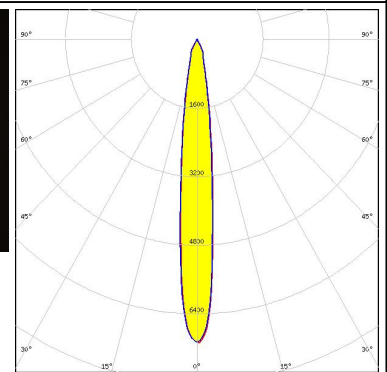
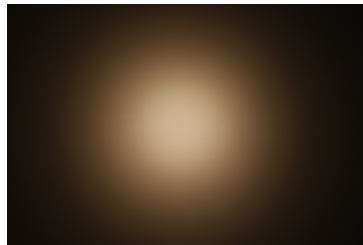

CREE LED

LED CMA1840
 FWHM / FWTM 13.0° / 33.0°
 Efficiency 85 %
 Peak intensity 7.7 cd/lm
 LEDs/each optic 1
 Light colour White
 Required components:
 C14146_LENA-STD-BASE-CXA18

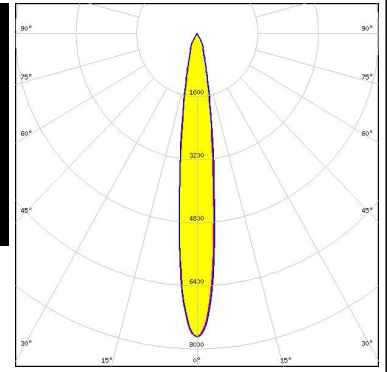

PHOTOMETRIC DATA (MEASURED):

CREE LED

LED CMA2550
 FWHM / FWTM 17.0° / 45.0°
 Efficiency 86 %
 Peak intensity 5.2 cd/lm
 LEDs/each optic 1
 Light colour White
 Required components:
 C13324_LENA-STD-BASE-CXA25

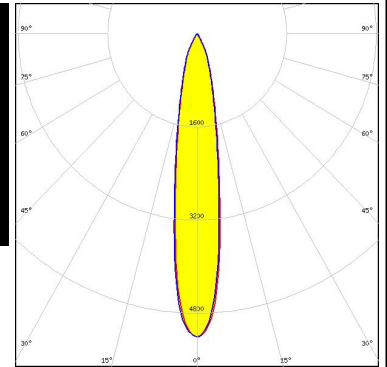
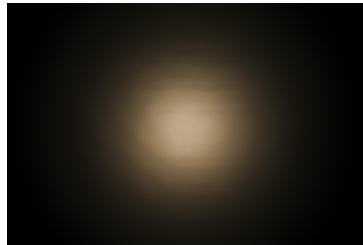

CREE LED

LED CMT14xx
 FWHM / FWTM 10.0° / 24.0°
 Efficiency 86 %
 Peak intensity 12.2 cd/lm
 LEDs/each optic 1
 Light colour White
 Required components:
 C13868_LENA-STD-BASE-VERO13-18
 Bender Wirth: 434 Typ L1

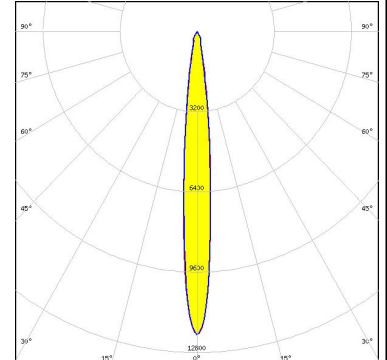

CREE LED

LED CMT19xx
 FWHM / FWTM 14.0° / 33.0°
 Efficiency 86 %
 Peak intensity 7.7 cd/lm
 LEDs/each optic 1
 Light colour White
 Required components:
 C12691_LENA-STD-BASE-CLL030

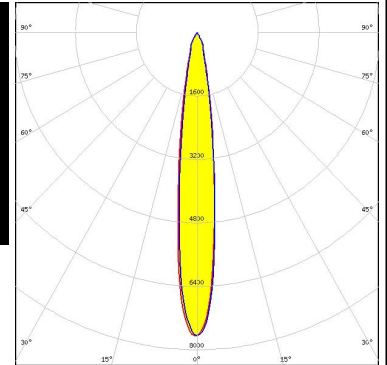
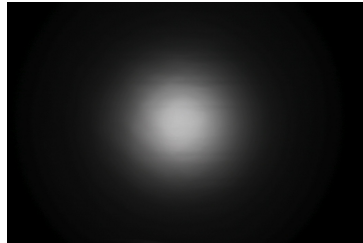

CREE LED

LED CMT19xx
 FWHM / FWTM 14.0° / 33.0°
 Efficiency 85 %
 Peak intensity 7.6 cd/lm
 LEDs/each optic 1
 Light colour White
 Required components:
 C13868_LENA-STD-BASE-VERO13-18
 Bender Wirth: 477 Typ L1

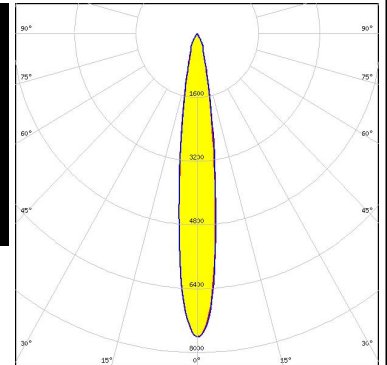

PHOTOMETRIC DATA (MEASURED):

CREE LED

LED CMT28xx
FWHM / FWTM 20.0° / 50.0°
Efficiency 85 %
Peak intensity 4.3 cd/lm
LEDs/each optic 1
Light colour White

Required components:

C13867_LENA-STD-BASE-VERO29
Bender Wirth: 471 Typ L3

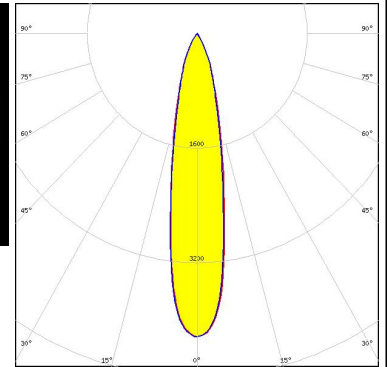

CREE LED

LED CMT28xx
FWHM / FWTM 20.0° / 50.0°
Efficiency 85 %
Peak intensity 4.3 cd/lm
LEDs/each optic 1
Light colour White

Required components:

C12692_LENA-STD-BASE-CLL040

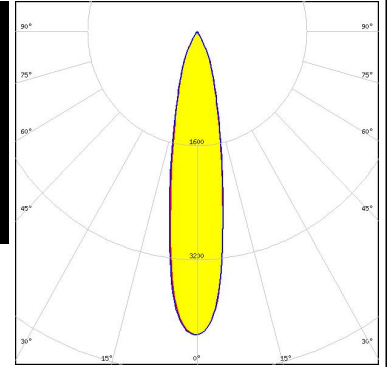

CREE LED

LED CXA/B 15xx
FWHM / FWTM 12.0° / 27.0°
Efficiency 82 %
Peak intensity 9.2 cd/lm
LEDs/each optic 1
Light colour White

Required components:

C13868_LENA-STD-BASE-VERO13-18
C11996_LENA-LENS
Bender Wirth: 441 Typ L1

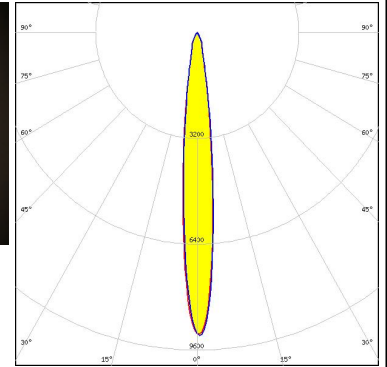

CREE LED

LED CXA/B 15xx
FWHM / FWTM 9.0° / 21.0°
Efficiency 87 %
Peak intensity 15.4 cd/lm
LEDs/each optic 1
Light colour White

Required components:

C13868_LENA-STD-BASE-VERO13-18
Bender Wirth: 441 Typ L1

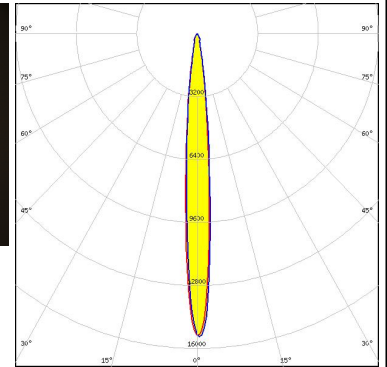

PHOTOMETRIC DATA (MEASURED):



LED CXA/B 1816 & CXA/B 1820 & CXA 1850
 FWHM / FWTM 11.0° / 26.0°
 Efficiency 89 %
 Peak intensity 11.3 cd/lm
 LEDs/each optic 1
 Light colour White
 Required components:
 C13868_LENA-STD-BASE-VERO13-18
 Bender Wirth: 437 Typ L1

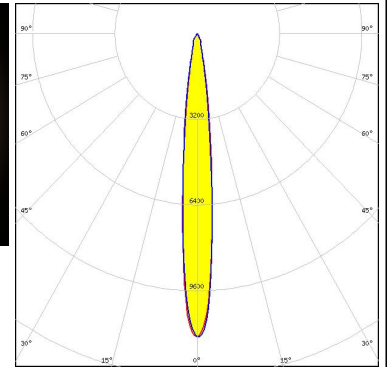

LED CXA/B 1816 & CXA/B 1820 & CXA 1850
 FWHM / FWTM 15.0° / 37.0°
 Efficiency 84 %
 Peak intensity 6 cd/lm
 LEDs/each optic 1
 Light colour White
 Required components:
 C13868_LENA-STD-BASE-VERO13-18
 C11996_LENA-LENS
 Bender Wirth: 437 Typ L1

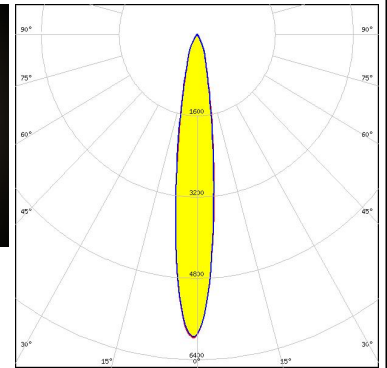

LED CXA/B 1830
 FWHM / FWTM 14.0° / 31.0°
 Efficiency 84 %
 Peak intensity 7.8 cd/lm
 LEDs/each optic 1
 Light colour White
 Required components:
 C13868_LENA-STD-BASE-VERO13-18
 C14169_LENA-CLEAR-LENS
 Bender Wirth: 437 Typ L1

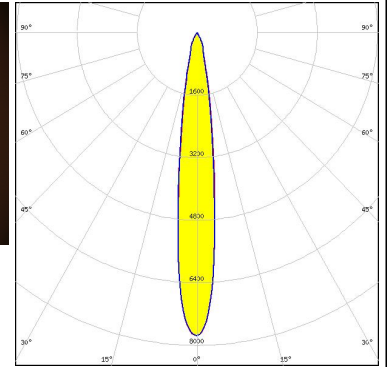

LED CXA/B 1830
 FWHM / FWTM 18.0° / 61.0°
 Efficiency 77 %
 Peak intensity 2.4 cd/lm
 LEDs/each optic 1
 Light colour White
 Required components:
 C13868_LENA-STD-BASE-VERO13-18
 C12231_LENA-FRESNEL
 Bender Wirth: 437 Typ L1

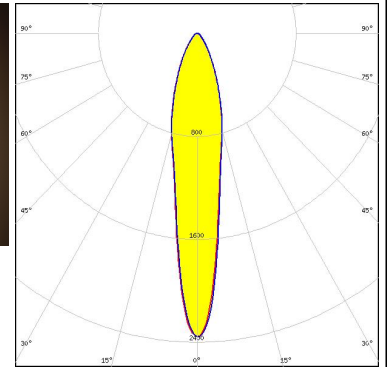
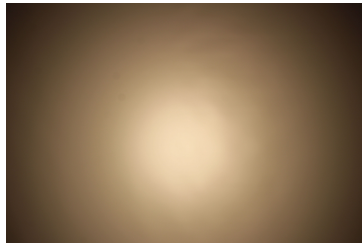

PHOTOMETRIC DATA (MEASURED):

CREE LED

LED CXA/B 1830
FWHM / FWTM 13.0° / 30.0°
Efficiency 89 %
Peak intensity 8.9 cd/lm
LEDs/each optic 1
Light colour White

Required components:

C13868_LENA-STD-BASE-VERO13-18
Bender Wirth: 437 Typ L1

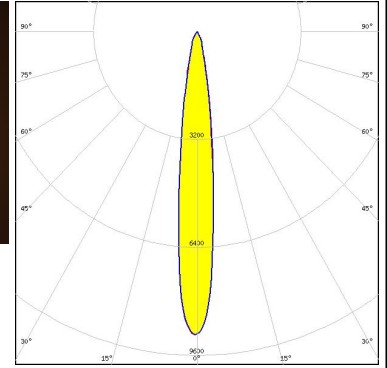

EVERLIGHT

LED CHI3030 19W
FWHM / FWTM 21.0° / 53.0°
Efficiency 83 %
Peak intensity 3.5 cd/lm
LEDs/each optic 1
Light colour White

Required components:

C13867_LENA-STD-BASE-VERO29
C11996_LENA-LENS
Bender Wirth: 468 Typ L3

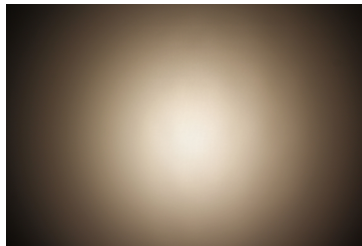

EVERLIGHT

LED CHI3030 29W
FWHM / FWTM 28.0° / 59.0°
Efficiency 82 %
Peak intensity 2.5 cd/lm
LEDs/each optic 1
Light colour White

Required components:

C13867_LENA-STD-BASE-VERO29
C11996_LENA-LENS
Bender Wirth: 468 Typ L3

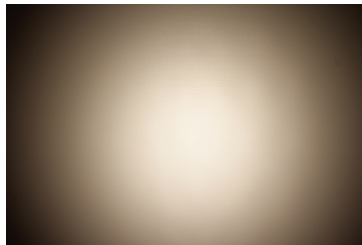

LITEON

LED LTPL-M036
FWHM / FWTM 9.0° / 24.0°
Efficiency 77 %
Peak intensity 13.5 cd/lm
LEDs/each optic 1
Light colour White

Required components:

C13186_LENA-STD-BASE-CXA15

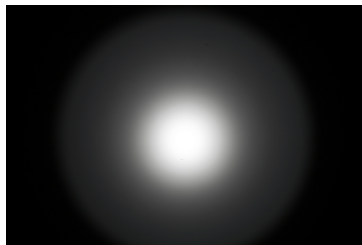

PHOTOMETRIC DATA (MEASURED):

LUMILEDS

LED LUXEON CoB 1204HD
 FWHM / FWTM 10.0° / 23.0°
 Efficiency 85 %
 Peak intensity 13.1 cd/lm
 LEDs/each optic 1
 Light colour White
 Required components:
 C11981_LENA-STD-BASE-COB-L110

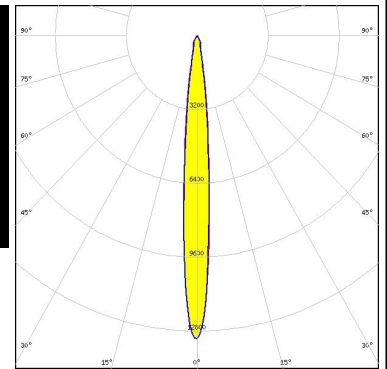
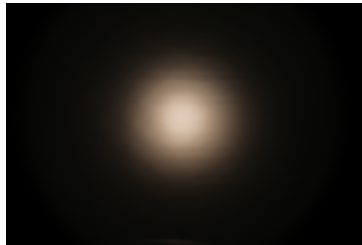

LUMILEDS

LED LUXEON CoB 1205HD
 FWHM / FWTM 26.5° / 11.6°
 Efficiency 85 %
 Peak intensity 10.5 cd/lm
 LEDs/each optic 1
 Light colour White
 Required components:
 C11981_LENA-STD-BASE-COB-L110

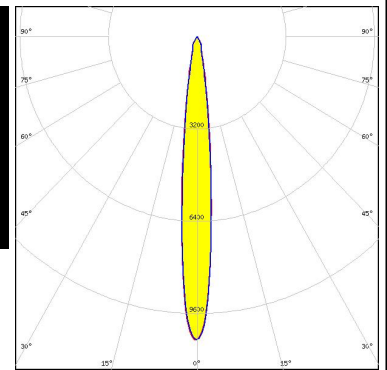

LUMILEDS

LED LUXEON CoB 1211
 FWHM / FWTM 19.0° / 47.0°
 Efficiency 82 %
 Peak intensity 4.2 cd/lm
 LEDs/each optic 1
 Light colour White
 Required components:
 C13867_LENA-STD-BASE-VERO29
 C11996_LENA-LENS
 Bender Wirth: 431 Typ L3

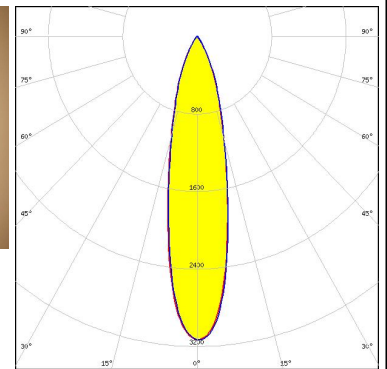
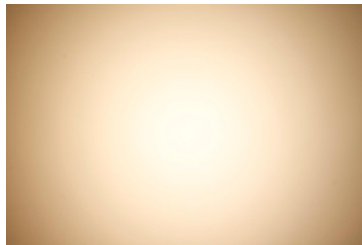



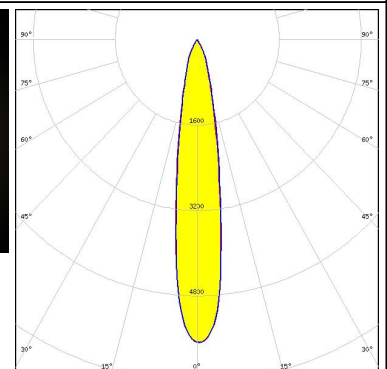
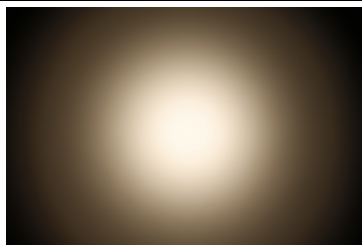

LUMILEDS



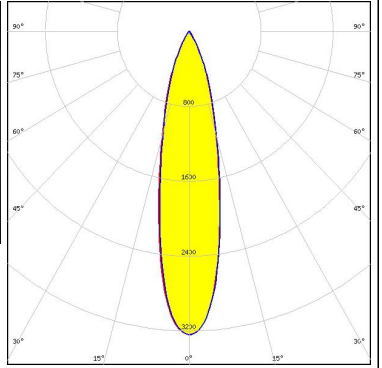

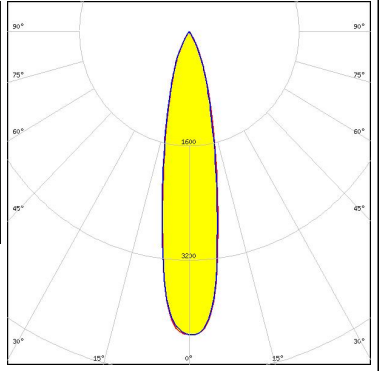

LED LUXEON CoB 1211
 FWHM / FWTM 17.0° / 41.0°
 Efficiency 87 %
 Peak intensity 6.6 cd/lm
 LEDs/each optic 1
 Light colour White
 Required components:
 C13867_LENA-STD-BASE-VERO29
 Bender Wirth: 431 Typ L3



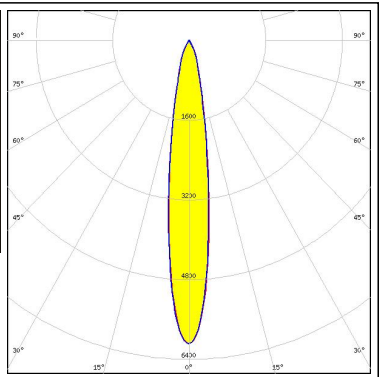

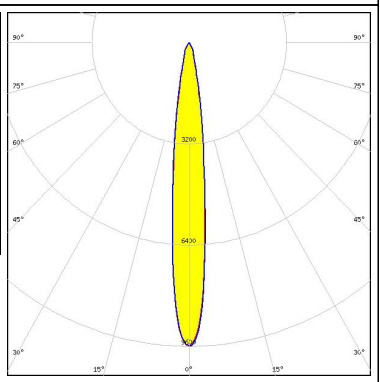

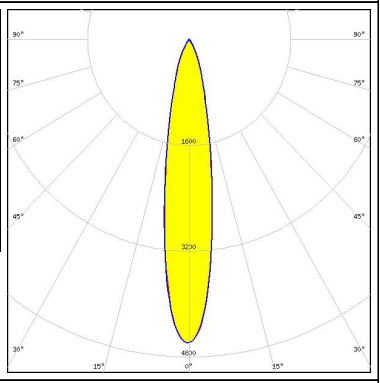

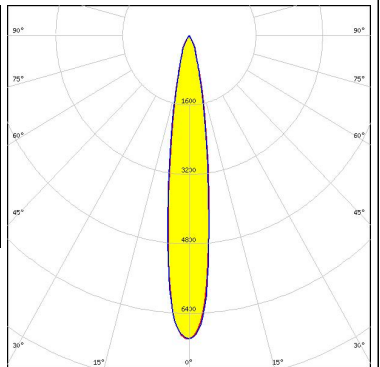
PHOTOMETRIC DATA (MEASURED):

<p>LUMILEDS</p> <p>LED LUXEON CoB 1216/1812</p> <p>FWHM / FWTM 24.0° / 52.0°</p> <p>Efficiency 82 %</p> <p>Peak intensity 3.2 cd/lm</p> <p>LEDs/each optic 1</p> <p>Light colour White</p> <p>Required components: C12692_LENA-STD-BASE-CLL040 C11996_LENA-LENS</p>		
<p>LUMILEDS</p> <p>LED LUXEON CoB 1216/1812</p> <p>FWHM / FWTM 21.0° / 49.0°</p> <p>Efficiency 87 %</p> <p>Peak intensity 4.3 cd/lm</p> <p>LEDs/each optic 1</p> <p>Light colour White</p> <p>Required components: C12692_LENA-STD-BASE-CLL040</p>		
<p>LUMILEDS</p> <p>LED LUXEON K12</p> <p>FWHM / FWTM 14.0° / 39.0°</p> <p>Efficiency 75 %</p> <p>Peak intensity 6.2 cd/lm</p> <p>LEDs/each optic 1</p> <p>Light colour White</p> <p>Required components: C12924_LENA-STD-BASE-LUXEON-K C11996_LENA-LENS</p>		
<p>LUMILEDS</p> <p>LED LUXEON K16</p> <p>FWHM / FWTM 15.0° / 40.0°</p> <p>Efficiency 73 %</p> <p>Peak intensity 5 cd/lm</p> <p>LEDs/each optic 1</p> <p>Light colour White</p> <p>Required components: C12924_LENA-STD-BASE-LUXEON-K C11996_LENA-LENS</p>		

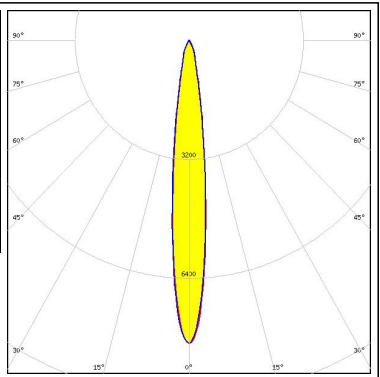

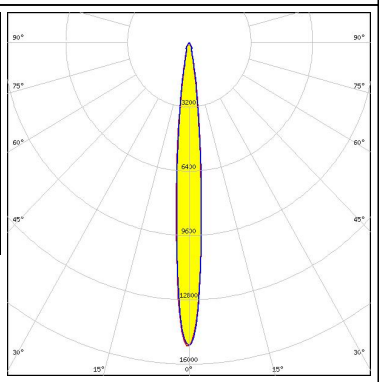

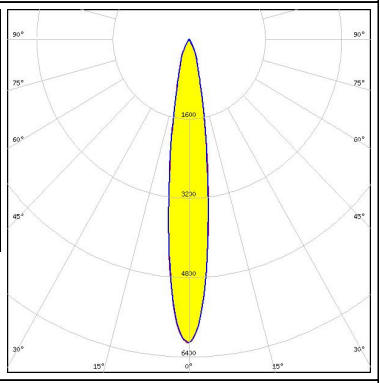

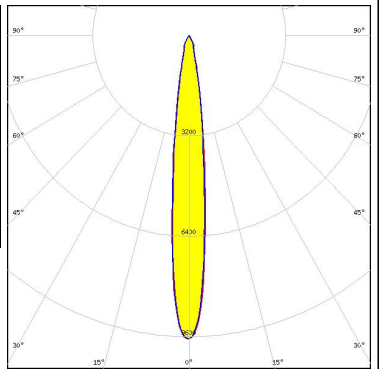
PHOTOMETRIC DATA (MEASURED):

<p>LUMINUS</p> <p>LED CDM-14 (Dim-To-Warm)</p> <p>FWHM / FWTM 16.0° / 37.0°</p> <p>Efficiency 84 %</p> <p>Peak intensity 6.1 cd/lm</p> <p>LEDs/each optic 1</p> <p>Light colour White</p> <p>Required components: C13868_LENA-STD-BASE-VERO13-18 C11996_LENA-LENS Bender Wirth: 491 Typ L2</p>		
<p>LUMINUS</p> <p>LED CDM-14 (Dim-To-Warm)</p> <p>FWHM / FWTM 13.0° / 29.0°</p> <p>Efficiency 89 %</p> <p>Peak intensity 9.6 cd/lm</p> <p>LEDs/each optic 1</p> <p>Light colour White</p> <p>Required components: C13868_LENA-STD-BASE-VERO13-18 Bender Wirth: 491 Typ L2</p>		
<p>LUMINUS</p> <p>LED CDM-18 (Dim-To-Warm)</p> <p>FWHM / FWTM 19.0° / 45.0°</p> <p>Efficiency 84 %</p> <p>Peak intensity 4.6 cd/lm</p> <p>LEDs/each optic 1</p> <p>Light colour White</p> <p>Required components: C13868_LENA-STD-BASE-VERO13-18 C11996_LENA-LENS Bender Wirth: 491 Typ L2</p>		
<p>LUMINUS</p> <p>LED CDM-18 (Dim-To-Warm)</p> <p>FWHM / FWTM 16.0° / 36.0°</p> <p>Efficiency 89 %</p> <p>Peak intensity 7 cd/lm</p> <p>LEDs/each optic 1</p> <p>Light colour White</p> <p>Required components: C13868_LENA-STD-BASE-VERO13-18 Bender Wirth: 491 Typ L2</p>		

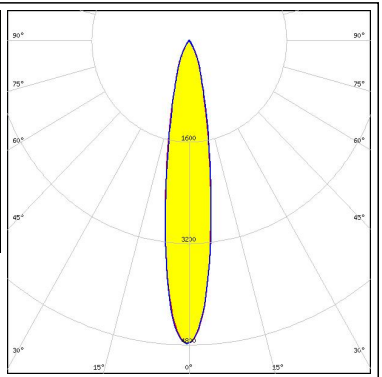
PHOTOMETRIC DATA (MEASURED):

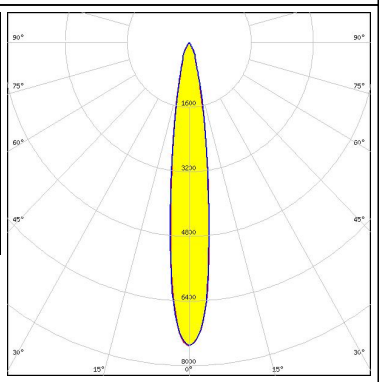
<p>LUMINUS</p> <p>LED CDM-9 (Dim-To-Warm) FWHM / FWTM 13.0° / 30.0° Efficiency 84 % Peak intensity 8.2 cd/lm LEDs/each optic 1 Light colour White</p> <p>Required components: C13868_LENA-STD-BASE-VERO13-18 C11996_LENA-LENS Bender Wirth: 490 Typ L1</p>		
<p>LUMINUS</p> <p>LED CDM-9 (Dim-To-Warm) FWHM / FWTM 10.0° / 22.0° Efficiency 89 % Peak intensity 15.2 cd/lm LEDs/each optic 1 Light colour White</p> <p>Required components: C13868_LENA-STD-BASE-VERO13-18 Bender Wirth: 490 Typ L1</p>		
<p>LUMINUS</p> <p>LED CTM-14 (Tunable White) FWHM / FWTM 15.0° / 36.0° Efficiency 83 % Peak intensity 6.1 cd/lm LEDs/each optic 1 Light colour White</p> <p>Required components: C13867_LENA-STD-BASE-VERO29 C12606_LENINA-DL Bender Wirth: 442 Typ L3</p>		
<p>LUMINUS</p> <p>LED CTM-14 (Tunable White) FWHM / FWTM 13.0° / 29.0° Efficiency 89 % Peak intensity 9.7 cd/lm LEDs/each optic 1 Light colour White</p> <p>Required components: C13867_LENA-STD-BASE-VERO29 Bender Wirth: 442 Typ L3</p>		

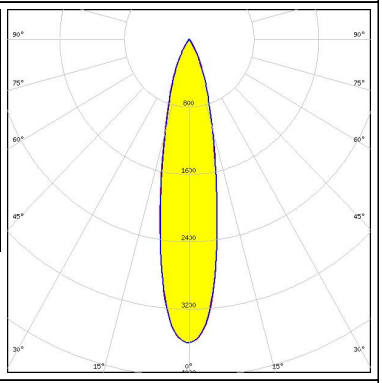
PHOTOMETRIC DATA (MEASURED):

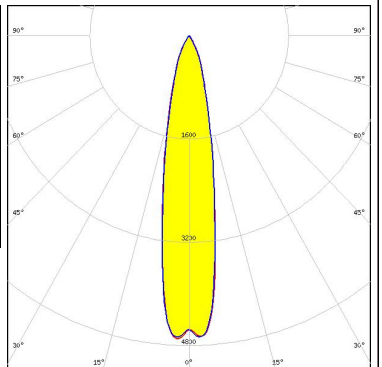
<p>LUMINUS</p> <p>LED CTM-18 (Tunable White) FWHM / FWTM 18.0° / 44.0° Efficiency 84 % Peak intensity 4.8 cd/lm LEDs/each optic 1 Light colour White</p> <p>Required components: C13867_LENA-STD-BASE-VERO29 C11996_LENA-LENS Bender Wirth: 442 Typ L3</p>		
<p>LUMINUS</p> <p>LED CTM-18 (Tunable White) FWHM / FWTM 15.0° / 34.0° Efficiency 89 % Peak intensity 7.5 cd/lm LEDs/each optic 1 Light colour White</p> <p>Required components: C13867_LENA-STD-BASE-VERO29 Bender Wirth: 442 Typ L3</p>		
<p>LUMINUS</p> <p>LED CTM-22 (Tunable White) FWHM / FWTM 22.0° / 51.0° Efficiency 84 % Peak intensity 3.6 cd/lm LEDs/each optic 1 Light colour White</p> <p>Required components: C13867_LENA-STD-BASE-VERO29 C11996_LENA-LENS Bender Wirth: 494 Typ L3</p>		
<p>LUMINUS</p> <p>LED CTM-22 (Tunable White) FWHM / FWTM 20.0° / 47.0° Efficiency 89 % Peak intensity 4.7 cd/lm LEDs/each optic 1 Light colour White</p> <p>Required components: C13867_LENA-STD-BASE-VERO29 Bender Wirth: 494 Typ L3</p>		

PHOTOMETRIC DATA (MEASURED):



LED CxM-22 (28x28)
 FWHM / FWTM 25.0° / 56.0°
 Efficiency 76 %
 Peak intensity 3 cd/lm
 LEDs/each optic 1
 Light colour White

Required components:

C12692_LENA-STD-BASE-CLL040
 C11996_LENA-LENS

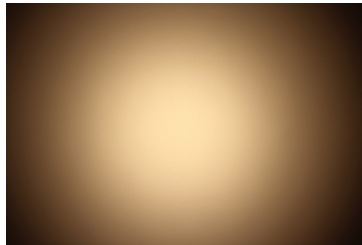

LED CxM-22 (28x28)
 FWHM / FWTM 23.0° / 56.0°
 Efficiency 81 %
 Peak intensity 3.8 cd/lm
 LEDs/each optic 1
 Light colour White

Required components:

C12692_LENA-STD-BASE-CLL040

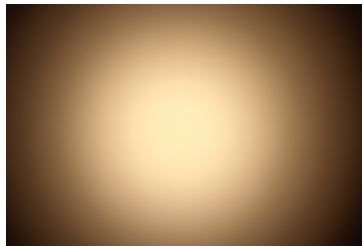

LED COB J-Type
 FWHM / FWTM 17.0° / 42.0°
 Efficiency 84 %
 Peak intensity 5 cd/lm
 LEDs/each optic 1
 Light colour White

Required components:

C13868_LENA-STD-BASE-VERO13-18
 C11996_LENA-LENS
 Bender Wirth: 463 Typ L2

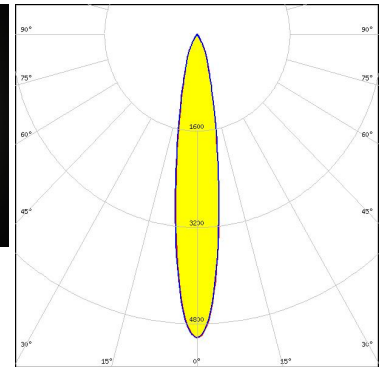
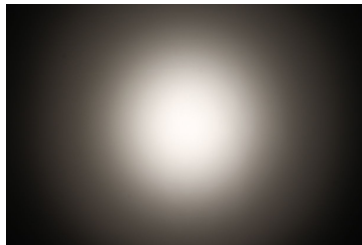





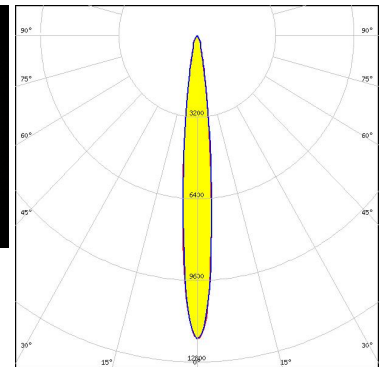

LED COB L-Type (LES 11)
 FWHM / FWTM 11.0° / 25.0°
 Efficiency 89 %
 Peak intensity 11.9 cd/lm
 LEDs/each optic 1
 Light colour White

Required components:

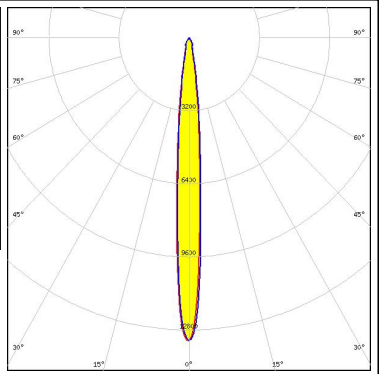
C13868_LENA-STD-BASE-VERO13-18
 Bender Wirth: 438 Typ L1

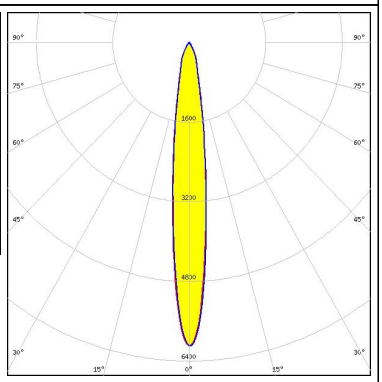

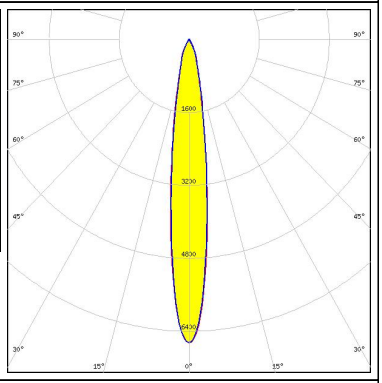
PHOTOMETRIC DATA (MEASURED):

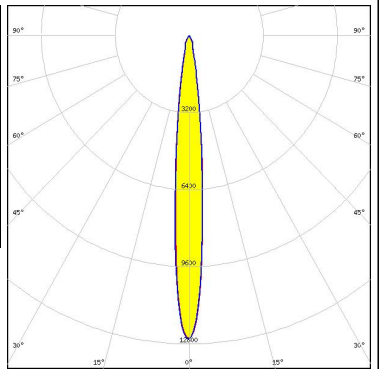
<p>NICHIA</p> <p>LED COB L-Type (LES 9)</p> <p>FWHM / FWTM 9.0° / 23.0°</p> <p>Efficiency 84 %</p> <p>Peak intensity 13.2 cd/lm</p> <p>LEDs/each optic 1</p> <p>Light colour White</p> <p>Required components: C13868_LENA-STD-BASE-VERO13-18 Bender Wirth: 438 Typ L1</p>		
<p>NICHIA</p> <p>LED COB L-Type (LES 9)</p> <p>FWHM / FWTM 13.0° / 34.0°</p> <p>Efficiency 78 %</p> <p>Peak intensity 6.1 cd/lm</p> <p>LEDs/each optic 1</p> <p>Light colour White</p> <p>Required components: C13868_LENA-STD-BASE-VERO13-18 C11996_LENA-LENS Bender Wirth: 438 Typ L1</p>		
<p>NICHIA</p> <p>LED NVCWJ024Z-V1MT: COB J-Type Tunable White</p> <p>FWHM / FWTM 14.0° / 35.0°</p> <p>Efficiency 84 %</p> <p>Peak intensity 6.7 cd/lm</p> <p>LEDs/each optic 1</p> <p>Light colour White</p> <p>Required components: C13868_LENA-STD-BASE-VERO13-18 C11996_LENA-LENS Bender Wirth: 498 Typ L2</p>		
<p>NICHIA</p> <p>LED NVCWJ024Z-V1MT: COB J-Type Tunable White</p> <p>FWHM / FWTM 11.0° / 25.0°</p> <p>Efficiency 89 %</p> <p>Peak intensity 12.6 cd/lm</p> <p>LEDs/each optic 1</p> <p>Light colour White</p> <p>Required components: C13868_LENA-STD-BASE-VERO13-18 Bender Wirth: 498 Typ L2</p>		

PHOTOMETRIC DATA (MEASURED):

OSRAM Opto Semiconductors

LED Soleriq S13
 FWHM / FWTM 12.0° / 27.0°
 Efficiency 87 %
 Peak intensity 11 cd/lm
 LEDs/each optic 1
 Light colour White
 Required components:
 C13868_LENA-STD-BASE-VERO13-18
 Bender Wirth: 437 Typ L1

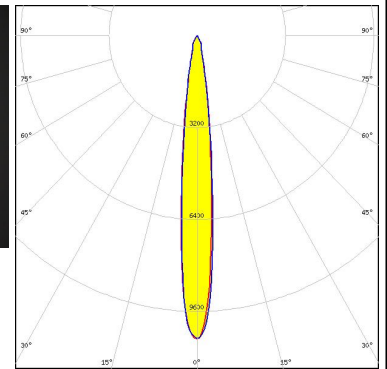
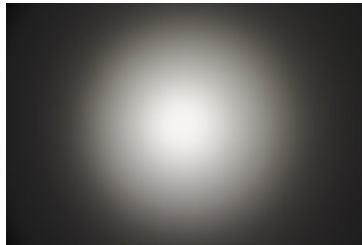

OSRAM Opto Semiconductors

LED Soleriq S13
 FWHM / FWTM 14.0° / 33.0°
 Efficiency 82 %
 Peak intensity 7 cd/lm
 LEDs/each optic 1
 Light colour White
 Required components:
 C13868_LENA-STD-BASE-VERO13-18
 C11996_LENA-LENS
 Bender Wirth: 437 Typ L1

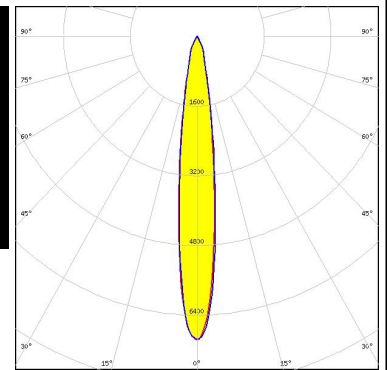

OSRAM Opto Semiconductors

LED Soleriq S19
 FWHM / FWTM 17.0° / 42.0°
 Efficiency 82 %
 Peak intensity 5 cd/lm
 LEDs/each optic 1
 Light colour White
 Required components:
 C13867_LENA-STD-BASE-VERO29
 C11996_LENA-LENS
 Bender Wirth: 462 Typ L3

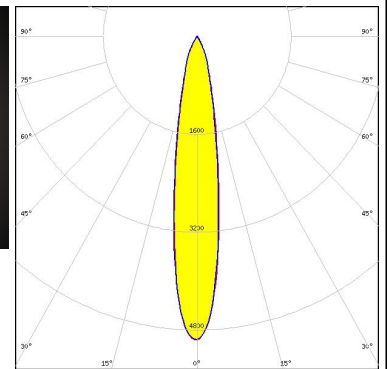
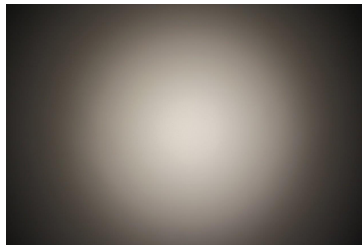

OSRAM Opto Semiconductors

LED Soleriq S19
 FWHM / FWTM 15.0° / 36.0°
 Efficiency 87 %
 Peak intensity 6.9 cd/lm
 LEDs/each optic 1
 Light colour White
 Required components:
 C13867_LENA-STD-BASE-VERO29
 Bender Wirth: 462 Typ L3

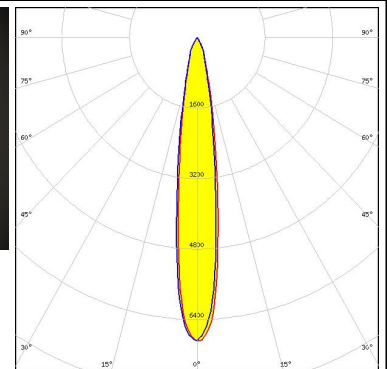
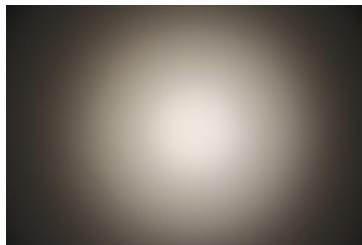

PHOTOMETRIC DATA (MEASURED):

PHILIPS

LED Fortimo SLM L13 CoB
 FWHM / FWTM 14.0° / 35.0°
 Efficiency 79 %
 Peak intensity 6.3 cd/m
 LEDs/each optic 1
 Light colour White
 Required components:
 C12292_LENA-STD-BASE-MEZ
 C11996_LENA-LENS



PHILIPS

LED Fortimo SLM L13 CoB
 FWHM / FWTM 13.0° / 31.0°
 Efficiency 85 %
 Peak intensity 8.5 cd/m
 LEDs/each optic 1
 Light colour White
 Required components:
 C12292_LENA-STD-BASE-MEZ



PHILIPS

LED Fortimo SLM L15 CoB
 FWHM / FWTM 16.0° / 40.0°
 Efficiency 79 %
 Peak intensity 5.2 cd/m
 LEDs/each optic 1
 Light colour White
 Required components:
 C12292_LENA-STD-BASE-MEZ
 C11996_LENA-LENS

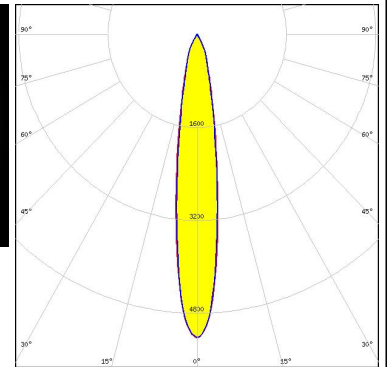
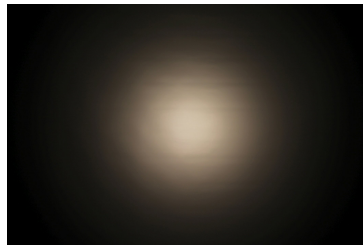

PHILIPS

LED Fortimo SLM L15 CoB
 FWHM / FWTM 15.0° / 35.0°
 Efficiency 85 %
 Peak intensity 7.1 cd/m
 LEDs/each optic 1
 Light colour White
 Required components:
 C12292_LENA-STD-BASE-MEZ

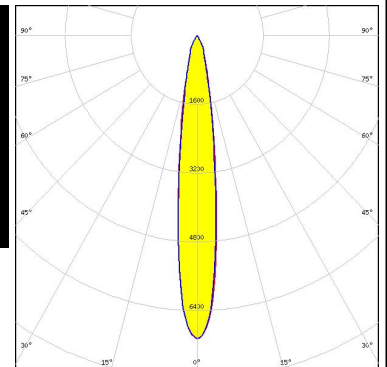
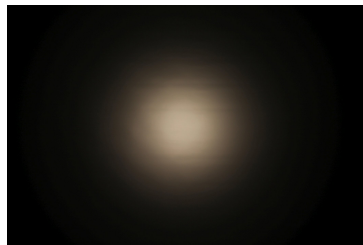

PHOTOMETRIC DATA (MEASURED):

PHILIPS

LED Fortimo SLM L19 CoB
 FWHM / FWTM 19.0° / 49.0°
 Efficiency 79 %
 Peak intensity 4 cd/m
 LEDs/each optic 1
 Light colour White
 Required components:
 C12692_LENA-STD-BASE-CLL040
 C11996_LENA-LENS

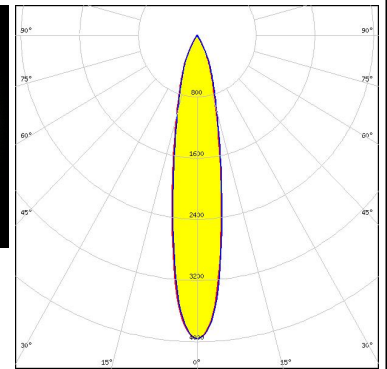
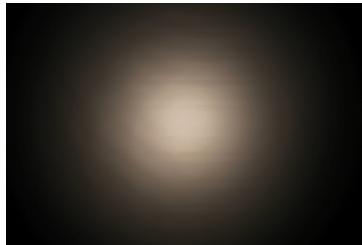

PHILIPS

LED Fortimo SLM L19 CoB
 FWHM / FWTM 18.0° / 44.0°
 Efficiency 85 %
 Peak intensity 5.2 cd/m
 LEDs/each optic 1
 Light colour White
 Required components:
 C12692_LENA-STD-BASE-CLL040

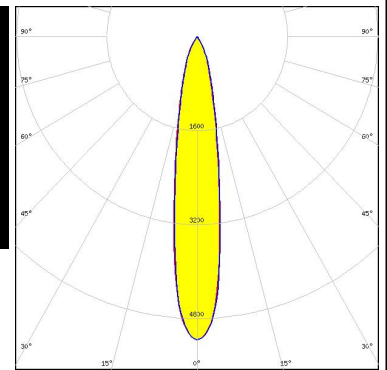
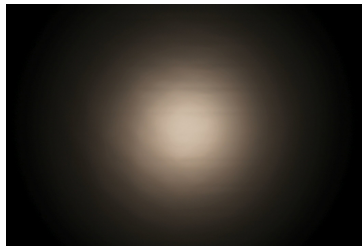

PHILIPS

LED Fortimo SLM L23 CoB
 FWHM / FWTM 21.0° / 51.0°
 Efficiency 85 %
 Peak intensity 4 cd/m
 LEDs/each optic 1
 Light colour White
 Required components:
 C12692_LENA-STD-BASE-CLL040

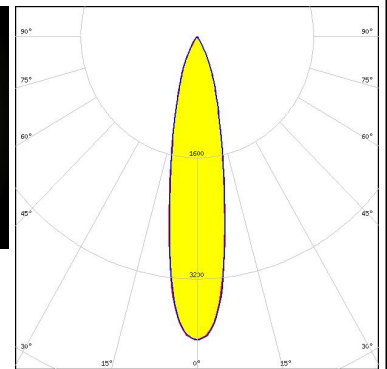
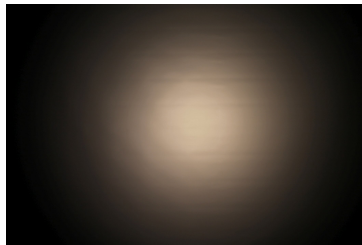

PHILIPS

LED Fortimo SLM L23 CoB
 FWHM / FWTM 23.0° / 53.0°
 Efficiency 79 %
 Peak intensity 3.2 cd/m
 LEDs/each optic 1
 Light colour White
 Required components:
 C12692_LENA-STD-BASE-CLL040
 C11996_LENA-LENS

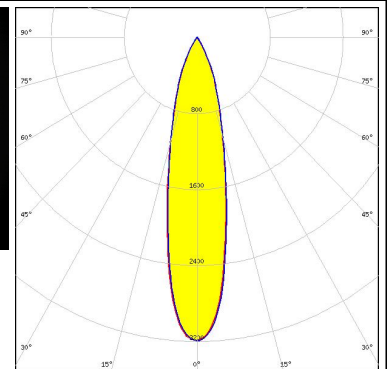
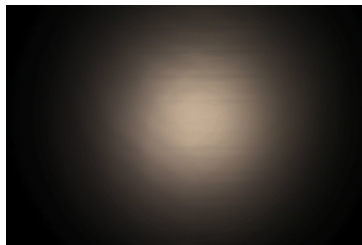

PHOTOMETRIC DATA (MEASURED):

SAMSUNG

LED LC016D / LC019D / LC026D / LC033D
 FWHM / FWTM 14.0° / 32.0°
 Efficiency 88 %
 Peak intensity 8.2 cd/lm
 LEDs/each optic 1
 Light colour White
 Required components:
 C12691_LENA-STD-BASE-CLL030

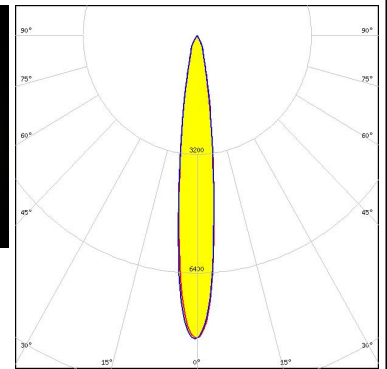

SAMSUNG

LED LC040D / LC060D / LC080D
 FWHM / FWTM 25.0° / 54.0°
 Efficiency 82 %
 Peak intensity 3.1 cd/lm
 LEDs/each optic 1
 Light colour White
 Required components:
 C12692_LENA-STD-BASE-CLL040
 C11996_LENA-LENS

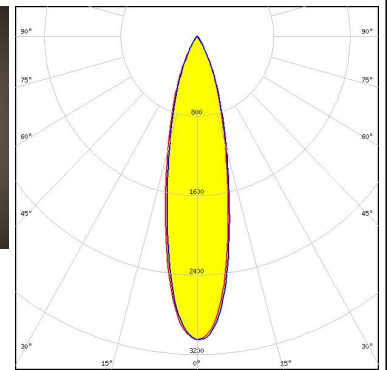
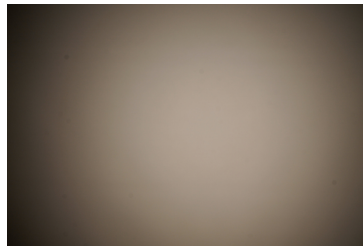

SAMSUNG

LED LC040D / LC060D / LC080D
 FWHM / FWTM 22.0° / 49.0°
 Efficiency 87 %
 Peak intensity 4.2 cd/lm
 LEDs/each optic 1
 Light colour White
 Required components:
 C12692_LENA-STD-BASE-CLL040

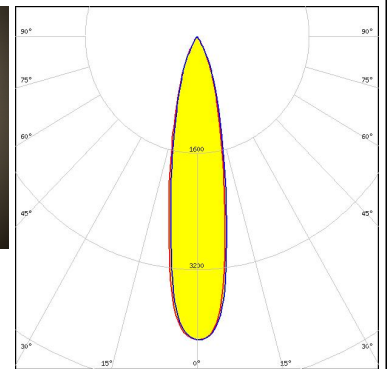
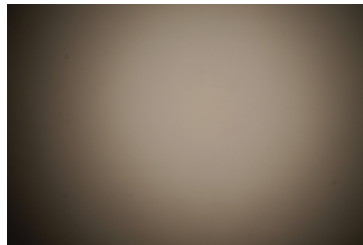





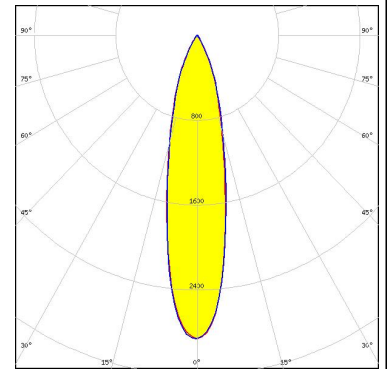

SEOL SEMICONDUCTOR

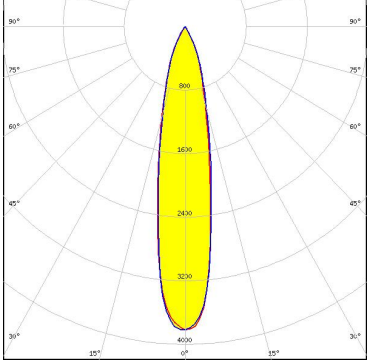
LED ZC25/40/60
 FWHM / FWTM 23.0° / 53.0°
 Efficiency 74 %
 Peak intensity 2.9 cd/lm
 LEDs/each optic 1
 Light colour White
 Required components:
 C12692_LENA-STD-BASE-CLL040
 C11996_LENA-LENS

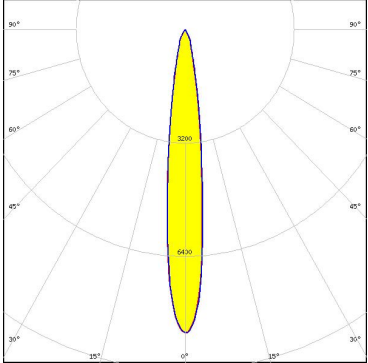

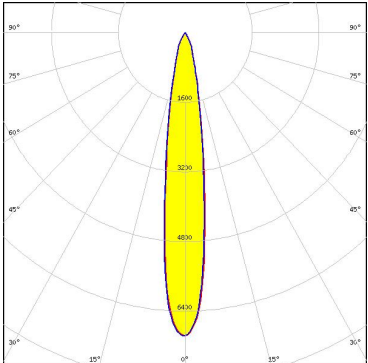
PHOTOMETRIC DATA (MEASURED):

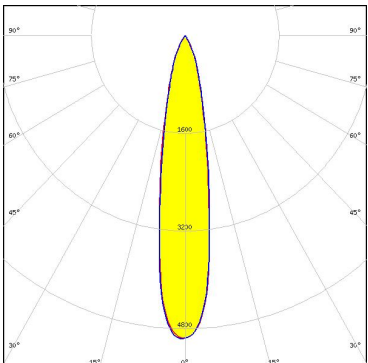
<p>SEUL SEOUL SEMICONDUCTOR</p> <p>LED ZC25/40/60 FWHM / FWTM 21.0° / 50.0° Efficiency 80 % Peak intensity 3.8 cd/lm LEDs/each optic 1 Light colour White Required components: C12692_LENA-STD-BASE-CLL040</p>		
<p>TRIDONIC</p> <p>LED SLE G7 LES15 FWHM / FWTM 14.0° / 32.0° Efficiency 90 % Peak intensity 8.6 cd/lm LEDs/each optic 1 Light colour White Required components: C12691_LENA-STD-BASE-CLL030</p>		
<p>TRIDONIC</p> <p>LED SLE G7 LES17 H FWHM / FWTM 15.0° / 36.0° Efficiency 88 % Peak intensity 7 cd/lm LEDs/each optic 1 Light colour White Required components: C14547_LENA-ADAPTER-B</p>		
<p>TRIDONIC</p> <p>LED SLE G7 LES21 H FWHM / FWTM 19.0° / 46.0° Efficiency 88 % Peak intensity 5 cd/lm LEDs/each optic 1 Light colour White Required components: C14547_LENA-ADAPTER-B</p>		





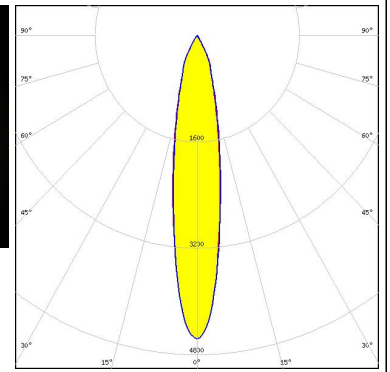
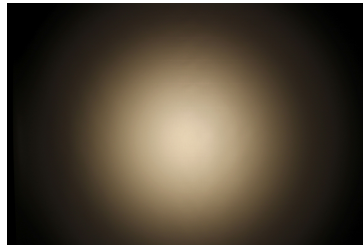

PHOTOMETRIC DATA (MEASURED):

XICATO

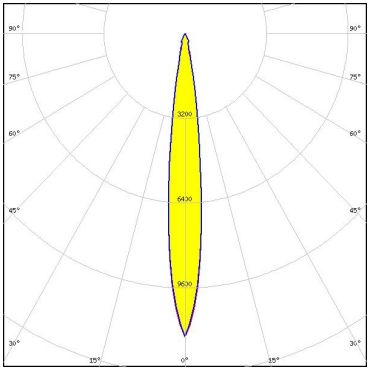

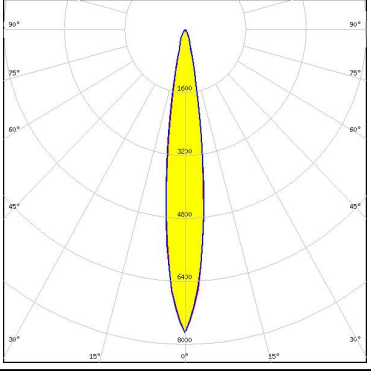

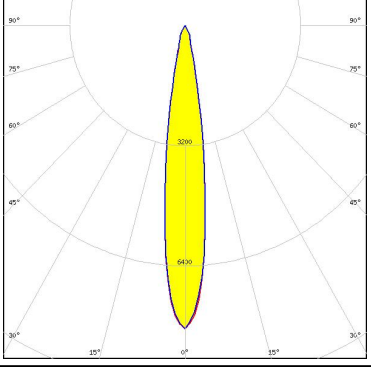
LED XOB 14.5 mm
FWHM / FWTM 19.0° / 51.0°
Efficiency 88 %
Peak intensity 4.6 cd/lm
LEDs/each optic 1
Light colour White
Required components:
C12691_LENA-STD-BASE-CLL030

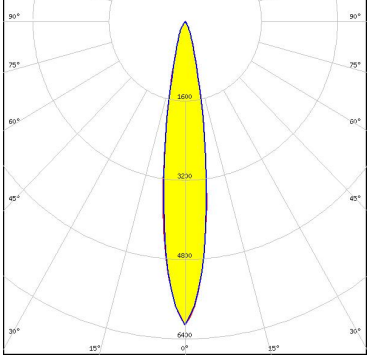

PHOTOMETRIC DATA (SIMULATED):

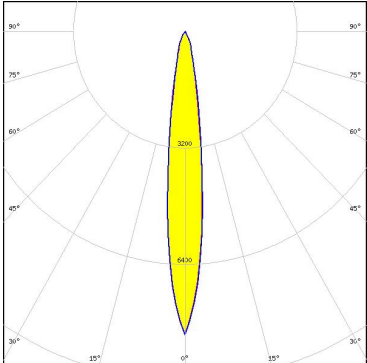
<p></p> <p>LED V10 Gen7 FWHM / FWTM 13.0° / 25.0° Efficiency 89 % Peak intensity 11.5 cd/lm LEDs/each optic 1 Light colour White Required components: C13868_LENA-STD-BASE-VERO13-18 Bender Wirth: 486 Typ L1</p>	
<p></p> <p>LED V10 Gen7 FWHM / FWTM 15.0° / 30.0° Efficiency 79 % Peak intensity 7.7 cd/lm LEDs/each optic 1 Light colour White Required components: C13868_LENA-STD-BASE-VERO13-18 C11996_LENA-LENS Bender Wirth: 486 Typ L1</p>	
<p></p> <p>LED V13 Gen7 FWHM / FWTM 16.0° / 31.0° Efficiency 88 % Peak intensity 8.1 cd/lm LEDs/each optic 1 Light colour White Required components: C13868_LENA-STD-BASE-VERO13-18 Bender Wirth: 477 Typ L1</p>	
<p></p> <p>LED V13 Gen7 FWHM / FWTM 17.0° / 35.0° Efficiency 81 % Peak intensity 6.1 cd/lm LEDs/each optic 1 Light colour White Required components: C13868_LENA-STD-BASE-VERO13-18 C11996_LENA-LENS Bender Wirth: 477 Typ L1</p>	

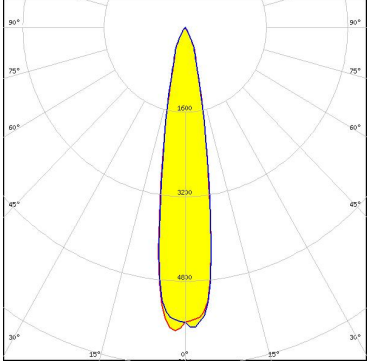
PHOTOMETRIC DATA (SIMULATED):

<p> bridgelux</p> <p>LED V13 Gen7 FWHM / FWTM 14.0° / 32.0° Efficiency 88 % Peak intensity 8.3 cd/lm LEDs/each optic 1 Light colour White Required components: IDEAL: 50-2103CT + 50-2100LN</p>	
<p> bridgelux</p> <p>LED V22 Gen7 FWHM / FWTM 18.0° / 41.0° Efficiency 93 % Peak intensity 5.7 cd/lm LEDs/each optic 1 Light colour White Required components: C13867_LENA-STD-BASE-VERO29 Bender Wirth: 431 Typ L3</p>	
<p> LUMINUS</p> <p>LED CxM-14 (19x19) FWHM / FWTM 17.0° / 41.0° Efficiency 82 % Peak intensity 5.2 cd/lm LEDs/each optic 1 Light colour White Required components: C13868_LENA-STD-BASE-VERO13-18 C11996_LENA-LENS Bender Wirth: 433 Typ L1</p>	
<p> LUMINUS</p> <p>LED CxM-14 (19x19) FWHM / FWTM 14.0° / 31.0° Efficiency 87 % Peak intensity 8.6 cd/lm LEDs/each optic 1 Light colour White Required components: C13868_LENA-STD-BASE-VERO13-18 Bender Wirth: 433 Typ L1</p>	

PHOTOMETRIC DATA (SIMULATED):



LED CxM-9 (13.5x13.5)
FWHM / FWTM 13.0° / 32.0°
Efficiency 82 %
Peak intensity 7.1 cd/lm
LEDs/each optic 1
Light colour White
Required components:
C13868_LENA-STD-BASE-VERO13-18
C11996_LENA-LENS
Bender Wirth: 434 Typ L1



LED CxM-9 (13.5x13.5)
FWHM / FWTM 10.0° / 22.0°
Efficiency 87 %
Peak intensity 14.2 cd/lm
LEDs/each optic 1
Light colour White
Required components:
C13868_LENA-STD-BASE-VERO13-18
Bender Wirth: 434 Typ L1



SEOUL SEMICONDUCTOR

LED ZC12/18
FWHM / FWTM 17.0° / 41.0°
Efficiency 82 %
Peak intensity 5.2 cd/lm
LEDs/each optic 1
Light colour White
Required components:
C13868_LENA-STD-BASE-VERO13-18
C11996_LENA-LENS
Bender Wirth: 433 Typ L1



SEOUL SEMICONDUCTOR

LED ZC12/18
FWHM / FWTM 14.0° / 31.0°
Efficiency 87 %
Peak intensity 8.6 cd/lm
LEDs/each optic 1
Light colour White
Required components:
C13868_LENA-STD-BASE-VERO13-18
Bender Wirth: 433 Typ L1

PHOTOMETRIC DATA (SIMULATED):

	
SEOL SEMICONDUCTOR	
LED	ZC4/6
FWHM / FWTM	13.0° / 32.0°
Efficiency	82 %
Peak intensity	7.1 cd/lm
LEDs/each optic	1
Light colour	White
Required components:	
C13868_LENA-STD-BASE-VERO13-18	
C11996_LENA-LENS	
Bender Wirth: 434 Typ L1	
<hr/>	
	
SEOL SEMICONDUCTOR	
LED	ZC4/6
FWHM / FWTM	10.0° / 22.0°
Efficiency	87 %
Peak intensity	14.2 cd/lm
LEDs/each optic	1
Light colour	White
Required components:	
C13868_LENA-STD-BASE-VERO13-18	
Bender Wirth: 434 Typ L1	

GENERAL INFORMATION:

NOTE: The typical beam angle will be changed by different color, chip size and chip position tolerance. The typical total beam angle is the full angle measured where the luminous intensity is half of the peak value.

Due to use of high power COB's with this product, special attention to proper thermal design is highly recommended. LEDiL has no liability for direct, indirect or consecutive damages arising from the LEDiL products being used outside of the recommended temperature range.

MATERIALS:

As part of our continuous research and improvement processes, and to ensure the best possible quality and availability of our products, LEDiL reserves the right to change material grades without notice.

PRODUCT DATA USER AGREEMENT AND DISCLAIMER:

The measured data in the provided downloadable LEDiL Product Datasheets and Mechanical 2D-Drawings is rounded and provided as reference for planning. LEDiL Oy's optical specifications have been verified by conducting performance testing of the products in accordance with the company's quality system. The reported data are averaged results of multiple measurements with typical variation. LEDiL Oy reserves the right to without prior notification make changes and improvements to its products.

LEDiL Oy assumes neither warranty, nor guarantee nor any other liability of any kind for the contents and correctness of the provided data. The provided data has been generated with highest diligence but the provided data may in reality not represent the complete possible variation range of all intrinsic parameters. Therefore, in certain cases a deviation from the provided data could occur.

LEDiL Oy reserves the right to undertake technical changes of its products without further notification which could lead to changes in the provided data. LEDiL Oy assumes no liability of any kind for the possible deviation from any provided data or any other damage resulting from the usage of the provided data.

The user agrees to this disclaimer and user agreement with the download or usage of the provided files.

LEDiL Oy

Joensuunkatu 13
FI-24240 SALO
Finland

LEDiL Inc.

228 West Page Street
Suite D
Sycamore IL 60178
USA

Ledil Optics Technology (Shenzhen) Co., Ltd.

405 , Block B
Casic Motor Building
Shenzhen 518057
P.R.CHINA

Local sales and technical support

[www.ledil.com/
where_to_buy](http://www.ledil.com/where_to_buy)

Shipping locations

Salo, Finland
Hong Kong, China

Distribution Partners

[www.ledil.com/
where_to_buy](http://www.ledil.com/where_to_buy)

X-ON Electronics

Largest Supplier of Electrical and Electronic Components

Click to view similar products for [LED Lighting Reflectors](#) category:

Click to view products by [Ledil](#) manufacturer:

Other Similar products are found below :

[LL04CR-CFN35155L02](#) [LL04CR-CFN60155L02](#) [LL04CR-CGM85135L02](#) [F13185_GERI-RZ](#) [10604](#) [LL01SP-ATH15R49](#) [10170](#) [12527](#)
[12531](#) [12568](#) [C13253_TINA2-R-CLIP16](#) [CA14591_BROOKE-XW](#) [F15560_MIRELLA-G2-W](#) [CA11525_LAURA-R-W](#) [12796](#) [LMH020-](#)
[REFL-0000-0000062](#) [LMH020-REFL-0000-0000082](#) [C12606_LENINA-DL](#) [CN12711_LENINA-W-DL](#) [C11394_TYRA-S](#) [C11396_TYRA-](#)
[W](#) [C11508_BROOKE-W](#) [C11552_BARBARA-S](#) [C11553_BARBARA-W](#) [C11862_MINNIE-W](#) [C11979_LENA-S](#) [C11980_LENA-W](#)
[C11996_LENA-LENS](#) [C12083_BROOKE-SCR-M](#) [C12095_MINNIE-M](#) [C12097_MINNIE-WWW](#) [C12154_LENA-M](#) [C12469_LISA2-R-](#)
[PIN](#) [C12476_MIRELLA-50-S](#) [C12477_MIRELLA-50-M](#) [C12480_MIRELLA-50-S-PIN](#) [C12516_RITA-WAS](#) [C12597_LENINA-S](#)
[C12599_LENINA-W](#) [C12948_LENA-WAS](#) [C12958_LENINA-XW](#) [C13085_MIRELLA-50-S-PF](#) [C13087_MIRELLA-50-W-PF](#)
[C13101_LENA-X-WAS](#) [C13555_BRIDGET-W-UNI](#) [C13556_BRIDGET-M-UNI](#) [C13557_BRIDGET-S-UNI](#) [C14346_ANGELETTE-WAS](#)
[C17099_ALISE-50-DL](#) [C17095_ALISE-70-CL](#)