

TINA2-R-CLIP16

Mini reflector with ~60° wide beam and clip installation

TECHNICAL SPECIFICATIONS:

| | |
|----------------|-----------|
| Dimensions | Ø 16.1 mm |
| Height | 10.1 mm |
| Fastening | clips |
| ROHS compliant | yes ⓘ |

MATERIAL SPECIFICATIONS:

| Component | Type | Material | Colour | Finish | Coating |
|----------------|-----------|----------|--------|--------|---------|
| TINA2-R-CLIP16 | Reflector | HRPC | clear | | |

ORDERING INFORMATION:



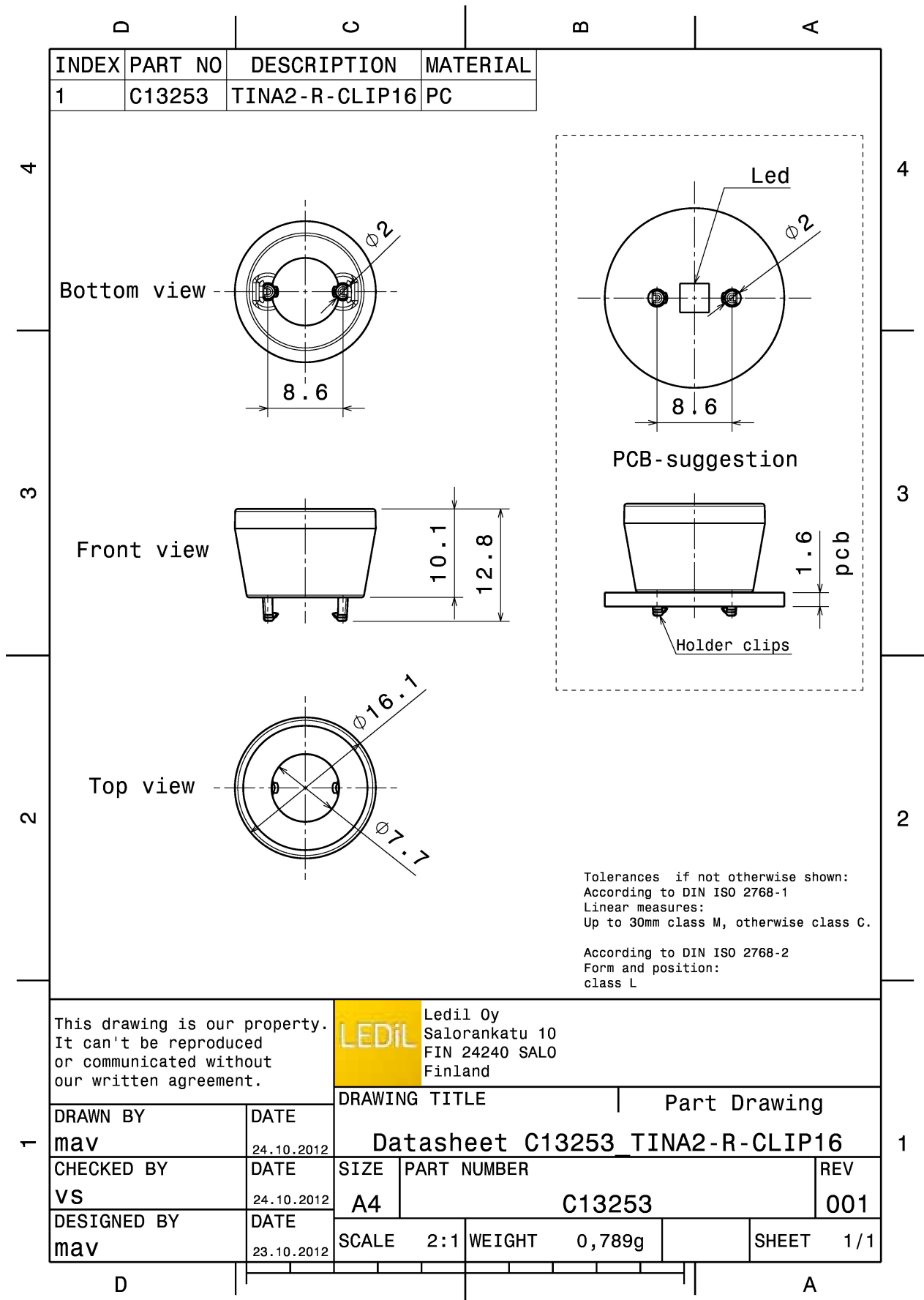

| Component | Qty in box | MOQ | MPQ | Box weight (kg) |
|---|------------|-----|-----|-----------------|
| C13253_TINA2-R-CLIP16 » Box size: 300 x 250 x 250 mm | | 300 | 50 | 3.8 |





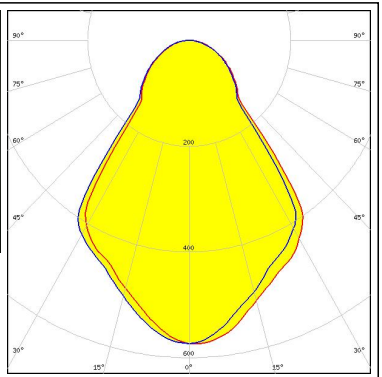

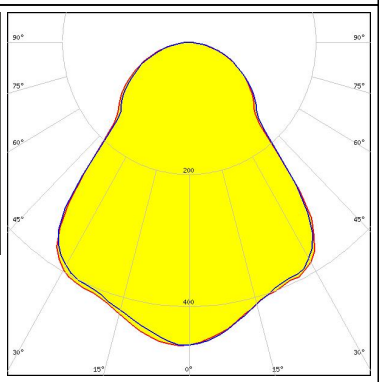
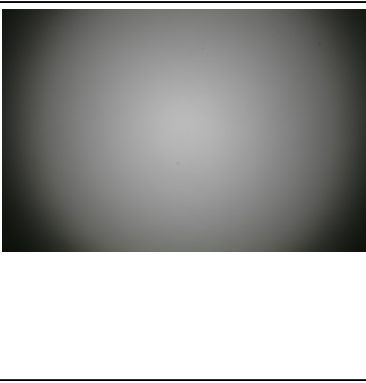
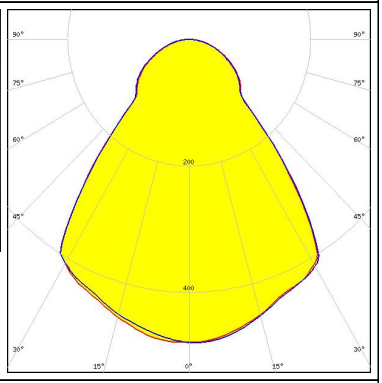

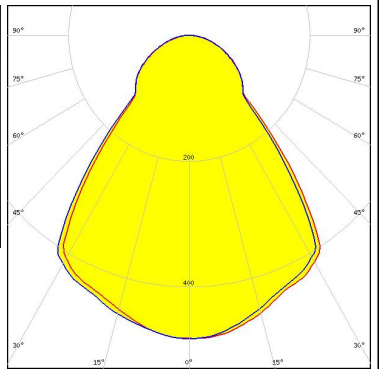



See also our general installation guide: www.ledil.com/installation_guide

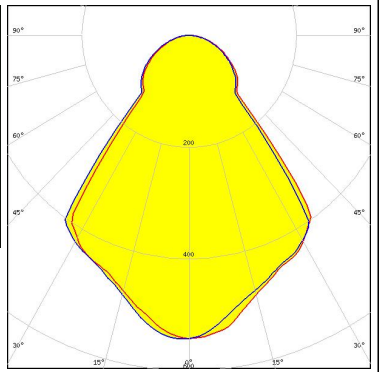

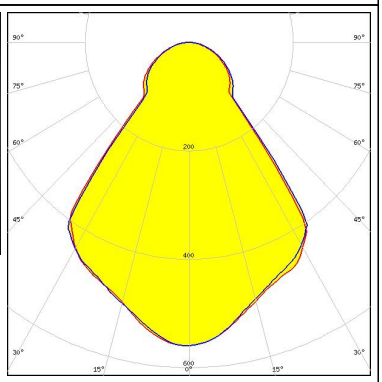
PHOTOMETRIC DATA (MEASURED):

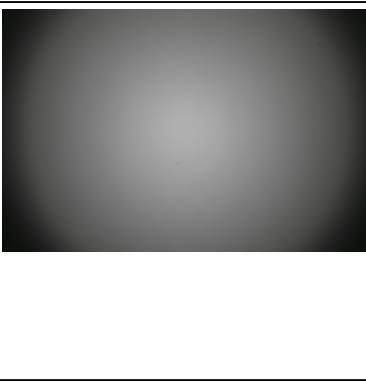
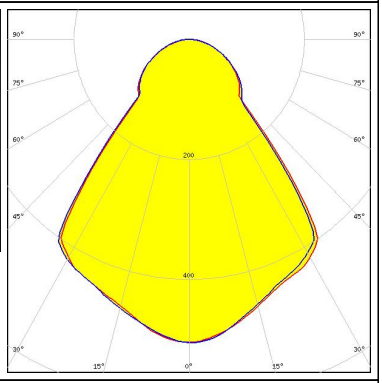
| | | |
|--|--|---|
| <p>CREE → LED</p> <p>LED XB-D White FWHM / FWTM 73.0° / 135.0° Efficiency 90 % Peak intensity 0.6 cd/lm LEDs/each optic 1 Light colour White Required components:</p> |  |  |
| <p>CREE → LED</p> <p>LED XB-H FWHM / FWTM 81.0° / 151.0° Efficiency 92 % Peak intensity 0.5 cd/lm LEDs/each optic 1 Light colour White Required components:</p> |  |  |
| <p>CREE → LED</p> <p>LED XM-L FWHM / FWTM 78.0° / 142.0° Efficiency 88 % Peak intensity 0.5 cd/lm LEDs/each optic 1 Light colour White Required components:</p> |  |  |
| <p>CREE → LED</p> <p>LED XM-L2 FWHM / FWTM 78.0° / 142.0° Efficiency 90 % Peak intensity 0.5 cd/lm LEDs/each optic 1 Light colour White Required components:</p> |  |  |

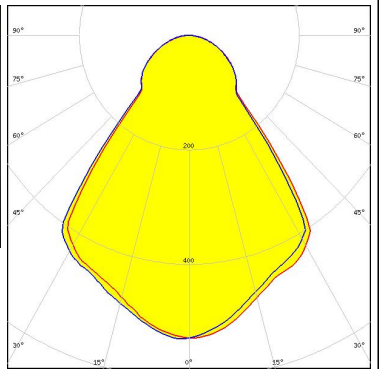
PHOTOMETRIC DATA (MEASURED):

| | | |
|--|--|---|
| <p>CREE  LED</p> <p>LED XP-E FWHM / FWTM 74.0° / 138.0° Efficiency 90 % Peak intensity 0.5 cd/lm LEDs/each optic 1 Light colour White Required components:</p> |  |  |
| <p>CREE  LED</p> <p>LED XP-E2 FWHM / FWTM 74.0° / 136.0° Efficiency 90 % Peak intensity 0.6 cd/lm LEDs/each optic 1 Light colour White Required components:</p> |  |  |
| <p>CREE  LED</p> <p>LED XP-G FWHM / FWTM 77.0° / 141.0° Efficiency 90 % Peak intensity 0.5 cd/lm LEDs/each optic 1 Light colour White Required components:</p> |  |  |
| <p>CREE  LED</p> <p>LED XP-G2 FWHM / FWTM 75.0° / 138.0° Efficiency 89 % Peak intensity 0.5 cd/lm LEDs/each optic 1 Light colour White Required components:</p> |  |  |

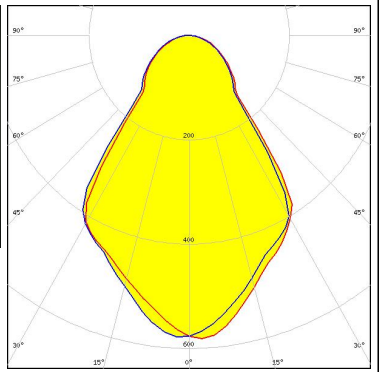
PHOTOMETRIC DATA (MEASURED):

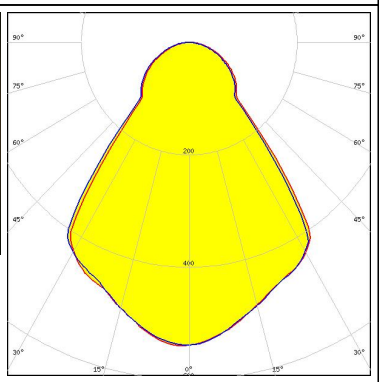
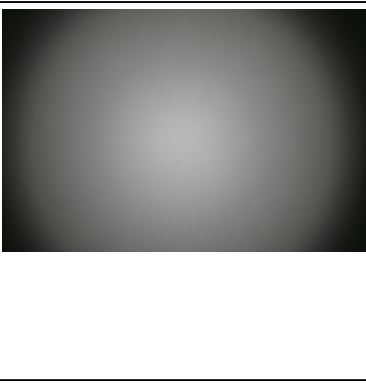
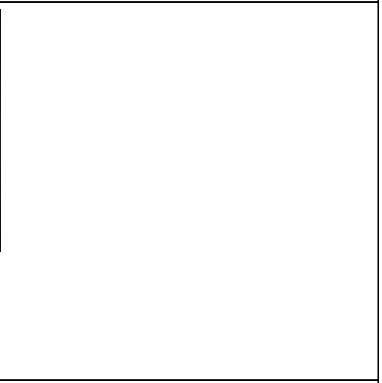
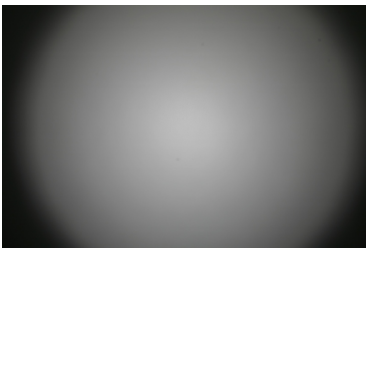
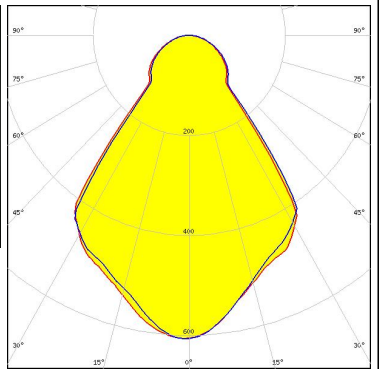
| | | |
|--|--|---|
| <p>CREE LED</p> <p>LED XT-E FWHM / FWTM 71.0° / 133.0° Efficiency 87 % Peak intensity 0.6 cd/lm LEDs/each optic 1 Light colour White Required components:</p> |  |  |
| <p>LUMILEDS</p> <p>LED LUXEON A FWHM / FWTM 75.0° / 138.0° Efficiency 91 % Peak intensity 0.5 cd/lm LEDs/each optic 1 Light colour White Required components:</p> |  |  |
| <p>LUMILEDS</p> <p>LED LUXEON R FWHM / FWTM 75.0° / 136.7° Efficiency 89 % Peak intensity 0.6 cd/lm LEDs/each optic 1 Light colour White Required components:</p> |  |  |
| <p>LUMILEDS</p> <p>LED LUXEON Rebel FWHM / FWTM 72.0° / 131.0° Efficiency 90 % Peak intensity 0.6 cd/lm LEDs/each optic 1 Light colour White Required components:</p> |  |  |

PHOTOMETRIC DATA (MEASURED):

LUMILEDS

LED LUXEON Rebel ES
 FWHM / FWTM 74.0° / 137.0°
 Efficiency 89 %
 Peak intensity 0.6 cd/lm
 LEDs/each optic 1
 Light colour White
 Required components:

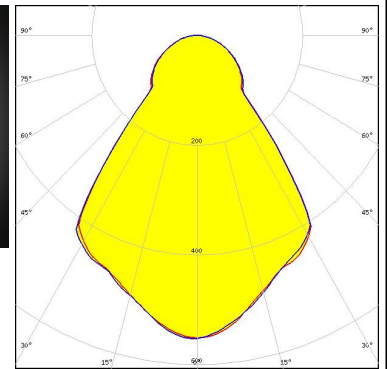
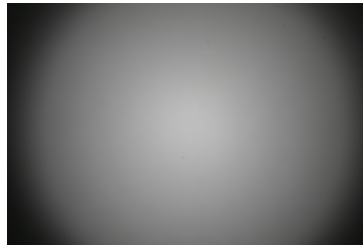

LUMILEDS

LED LUXEON T
 FWHM / FWTM 75.0° / 137.0°
 Efficiency 89 %
 Peak intensity 0.5 cd/lm
 LEDs/each optic 1
 Light colour White
 Required components:

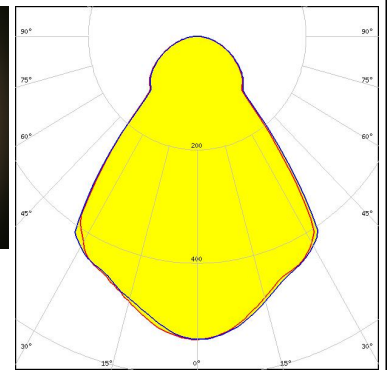
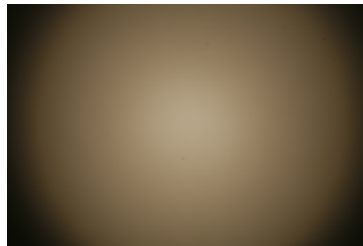

LUMILEDS

LED LUXEON TX
 FWHM / FWTM 81.0° / 151.0°
 Efficiency 90 %
 Peak intensity 0.5 cd/lm
 LEDs/each optic 1
 Light colour White
 Required components:

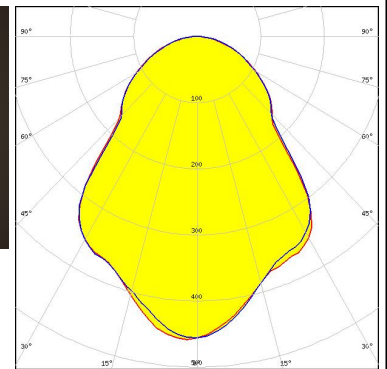
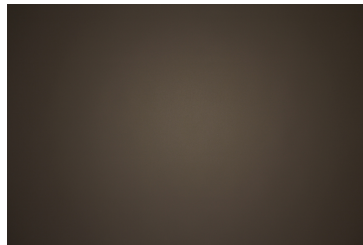

NICHIA



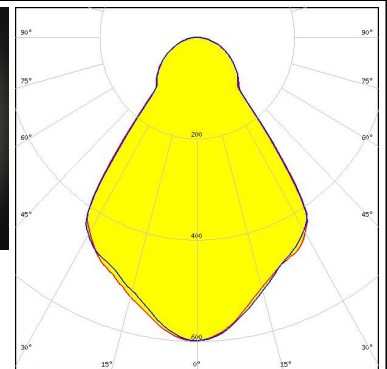
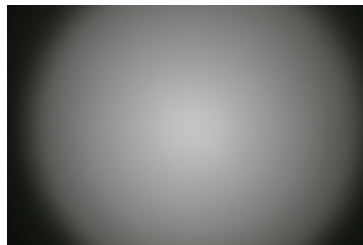

LED NCSxx19A
 FWHM / FWTM 72.0° / 132.0°
 Efficiency 90 %
 Peak intensity 0.6 cd/lm
 LEDs/each optic 1
 Light colour White
 Required components:

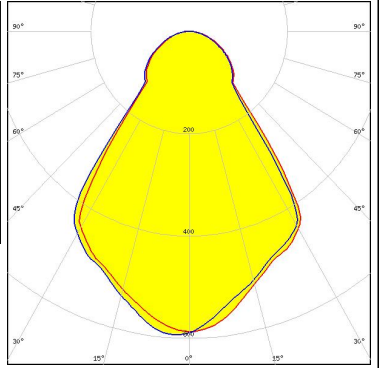
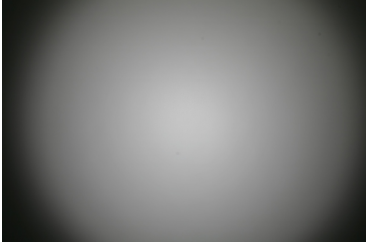
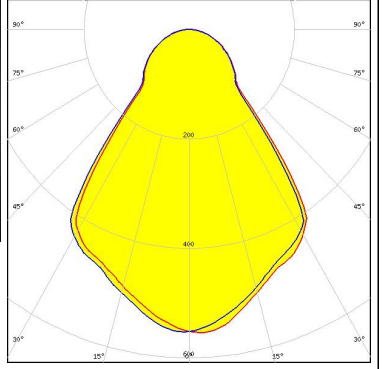
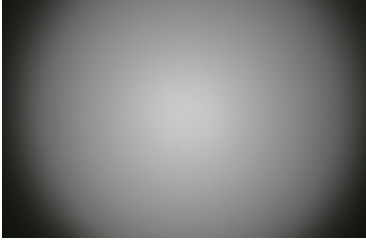
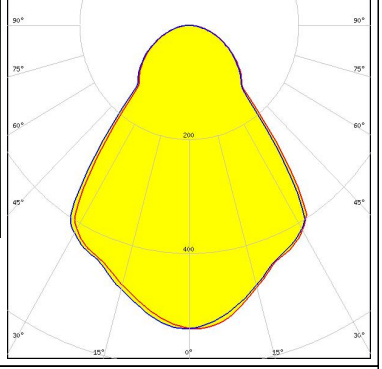
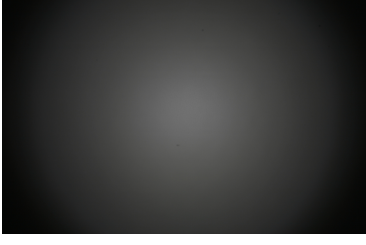
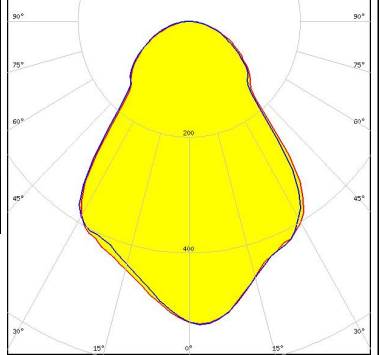

PHOTOMETRIC DATA (MEASURED):

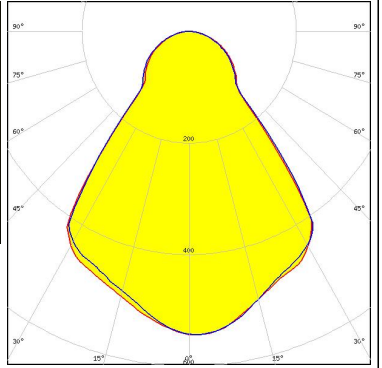
| | | |
|--|--|---|
| <p>NICHIA</p> <p>LED NF2x757A FWHM / FWTM 72.0° / 135.0° Efficiency 92 % Peak intensity 0.6 cd/lm LEDs/each optic 1 Light colour White Required components:</p> |  |  |
| <p>NICHIA</p> <p>LED NVSxx19A FWHM / FWTM 74.0° / 136.0° Efficiency 90 % Peak intensity 0.6 cd/lm LEDs/each optic 1 Light colour White Required components:</p> |  |  |
| <p>NICHIA</p> <p>LED NVSxx19B/NVSxx19C FWHM / FWTM 74.0° / 139.0° Efficiency 89 % Peak intensity 0.5 cd/lm LEDs/each optic 1 Light colour White Required components:</p> |  |  |
| <p>OSRAM <small>Opto Semiconductors</small></p> <p>LED Duris S5 (2 chip) FWHM / FWTM 76.0° / 144.0° Efficiency 91 % Peak intensity 0.5 cd/lm LEDs/each optic 1 Light colour White Required components:</p> |  |  |

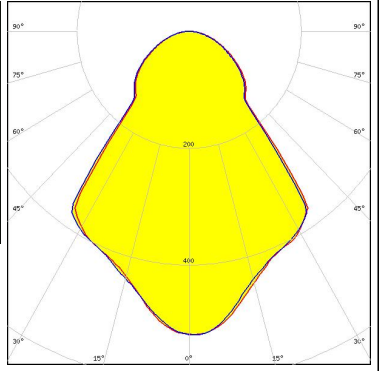
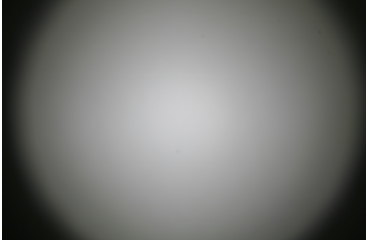
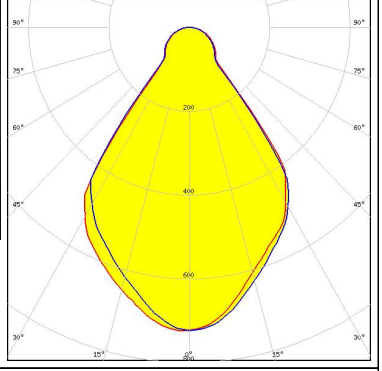
PHOTOMETRIC DATA (MEASURED):

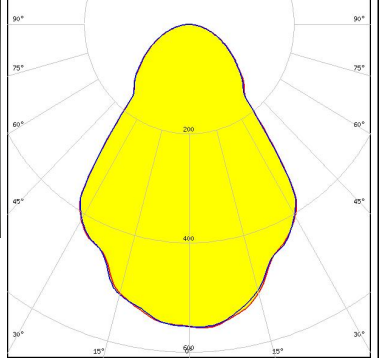
| | | |
|--|--|---|
| <p>OSRAM Opto Semiconductors</p> <p>LED OSLON Square EC</p> <p>FWHM / FWTM 75.0° / 138.0°</p> <p>Efficiency 91 %</p> <p>Peak intensity 0.5 cd/lm</p> <p>LEDs/each optic 1</p> <p>Light colour White</p> <p>Required components:</p> |  |  |
| <p>OSRAM Opto Semiconductors</p> <p>LED OSLON SSL 150</p> <p>FWHM / FWTM 75.0° / 140.0°</p> <p>Efficiency 88 %</p> <p>Peak intensity 0.5 cd/lm</p> <p>LEDs/each optic 1</p> <p>Light colour White</p> <p>Required components:</p> |  |  |
| <p>OSRAM Opto Semiconductors</p> <p>LED OSLON SSL 80</p> <p>FWHM / FWTM 71.0° / 108.0°</p> <p>Efficiency 91 %</p> <p>Peak intensity 0.7 cd/lm</p> <p>LEDs/each optic 1</p> <p>Light colour White</p> <p>Required components:</p> |  |  |
| <p>SEOUL SEMICONDUCTOR</p> <p>LED Z8Y15</p> <p>FWHM / FWTM 72.0° / 137.0°</p> <p>Efficiency 90 %</p> <p>Peak intensity 0.6 cd/lm</p> <p>LEDs/each optic 1</p> <p>Light colour White</p> <p>Required components:</p> |  |  |

PHOTOMETRIC DATA (MEASURED):

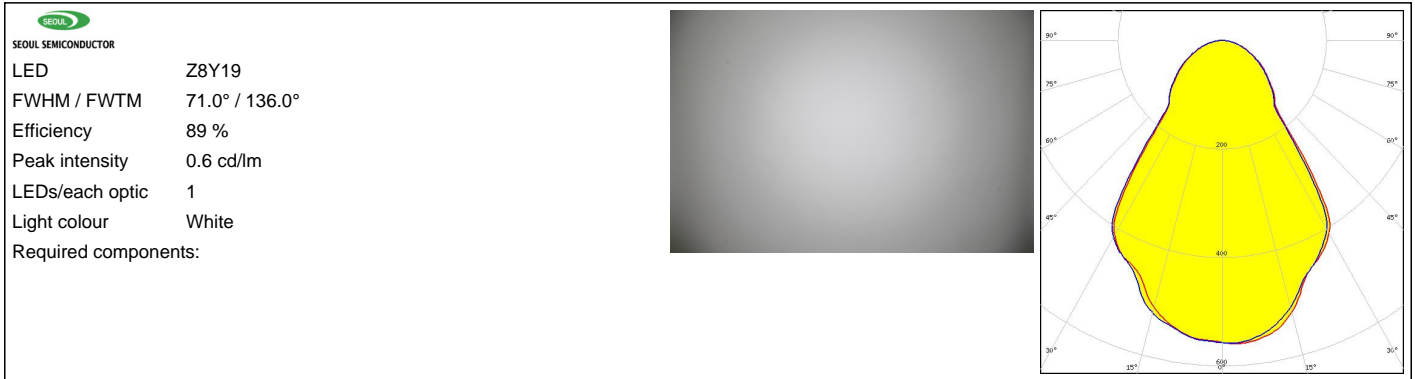

PHOTOMETRIC DATA (SIMULATED):



LED XP-G2 HE
 FWHM / FWTM 73.0° / 120.0°
 Efficiency 86 %
 Peak intensity 0.6 cd/lm
 LEDs/each optic 1
 Light colour White
 Required components:

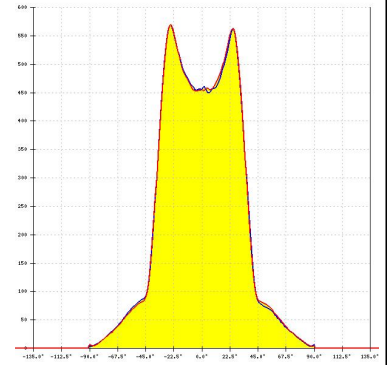

OSRAM Opto Semiconductors
 LED OSCONIQ P 3030
 FWHM / FWTM 74.0° / 134.0°
 Efficiency 86 %
 Peak intensity 0.5 cd/lm
 LEDs/each optic 1
 Light colour White
 Required components:

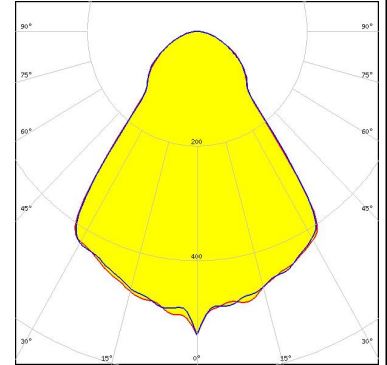

OSRAM Opto Semiconductors
 LED OSOLON Black
 FWHM / FWTM 71.0° / 125.0°
 Efficiency 80 %
 Peak intensity 0.6 cd/lm
 LEDs/each optic 1
 Light colour White
 Required components:

Protective plate, glass

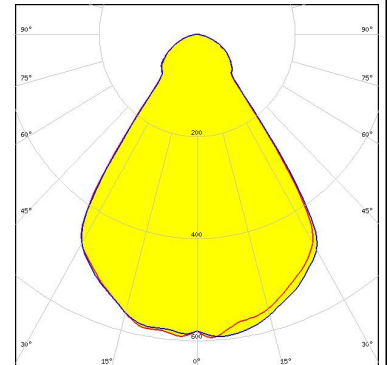

OSRAM Opto Semiconductors
 LED OSOLON Square CSSRM2/CSSRM3
 FWHM / FWTM 65.0° / 116.0°
 Efficiency 94 %
 Peak intensity 0.7 cd/lm
 LEDs/each optic 1
 Light colour White
 Required components:

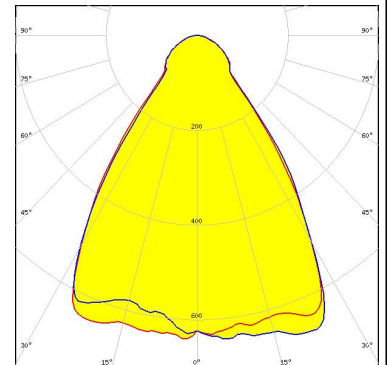

PHOTOMETRIC DATA (SIMULATED):

SAMSUNG

LED LH351B
FWHM / FWTM 78.0° / 138.0°
Efficiency 87 %
Peak intensity 0.5 cd/lm
LEDs/each optic 1
Light colour White
Required components:

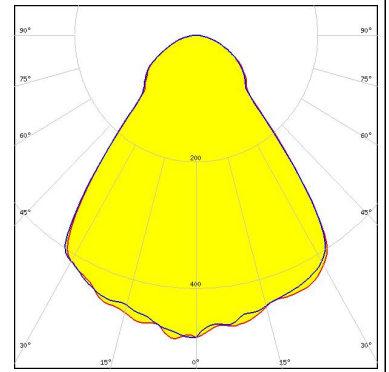

SAMSUNG

LED LH351C
FWHM / FWTM 79.0° / 140.0°
Efficiency 86 %
Peak intensity 0.5 cd/lm
LEDs/each optic 1
Light colour White
Required components:

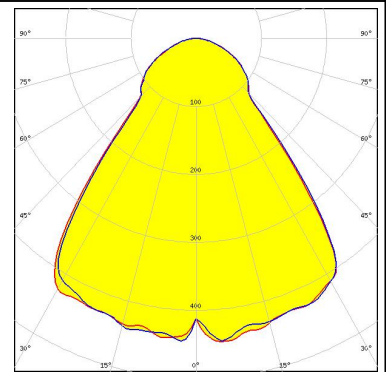

GENERAL INFORMATION:

NOTE: The typical beam angle will be changed by different color, chip size and chip position tolerance. The typical total beam angle is the full angle measured where the luminous intensity is half of the peak value.

MATERIALS:

As part of our continuous research and improvement processes, and to ensure the best possible quality and availability of our products, LEDiL reserves the right to change material grades without notice.

PRODUCT DATA USER AGREEMENT AND DISCLAIMER:

The measured data in the provided downloadable LEDiL Product Datasheets and Mechanical 2D-Drawings is rounded and provided as reference for planning. LEDiL Oy's optical specifications have been verified by conducting performance testing of the products in accordance with the company's quality system. The reported data are averaged results of multiple measurements with typical variation. LEDiL Oy reserves the right to without prior notification make changes and improvements to its products.

LEDiL Oy assumes neither warranty, nor guarantee nor any other liability of any kind for the contents and correctness of the provided data. The provided data has been generated with highest diligence but the provided data may in reality not represent the complete possible variation range of all intrinsic parameters. Therefore, in certain cases a deviation from the provided data could occur.

LEDiL Oy reserves the right to undertake technical changes of its products without further notification which could lead to changes in the provided data. LEDiL Oy assumes no liability of any kind for the possible deviation from any provided data or any other damage resulting from the usage of the provided data.

The user agrees to this disclaimer and user agreement with the download or usage of the provided files.

LEDiL Oy

Joensuunkatu 13
FI-24240 SALO
Finland

LEDiL Inc.

228 West Page Street
Suite D
Sycamore IL 60178
USA

Ledil Optics Technology (Shenzhen) Co., Ltd.

405 , Block B
Casic Motor Building
Shenzhen 518057
P.R.CHINA

Local sales and technical support

[www.ledil.com/
where_to_buy](http://www.ledil.com/where_to_buy)

Shipping locations

Salo, Finland
Hong Kong, China

Distribution Partners

[www.ledil.com/
where_to_buy](http://www.ledil.com/where_to_buy)

X-ON Electronics

Largest Supplier of Electrical and Electronic Components

Click to view similar products for [LED Lighting Reflectors](#) category:

Click to view products by [Ledil](#) manufacturer:

Other Similar products are found below :

[LL04CR-CFN35155L02](#) [LL04CR-CFN60155L02](#) [LL04CR-CGM85135L02](#) [F13185_GERI-RZ](#) [10604](#) [LL01SP-ATH15R49](#) [10170](#) [12527](#)
[12531](#) [12568](#) [C13253_TINA2-R-CLIP16](#) [CA14591_BROOKE-XW](#) [F15560_MIRELLA-G2-W](#) [CA11525_LAURA-R-W](#) [12796](#) [LMH020-](#)
[REFL-0000-0000062](#) [LMH020-REFL-0000-0000082](#) [C12606_LENINA-DL](#) [CN12711_LENINA-W-DL](#) [C11394_TYRA-S](#) [C11396_TYRA-](#)
[W](#) [C11508_BROOKE-W](#) [C11552_BARBARA-S](#) [C11553_BARBARA-W](#) [C11862_MINNIE-W](#) [C11979_LENA-S](#) [C11980_LENA-W](#)
[C11996_LENA-LENS](#) [C12083_BROOKE-SCR-M](#) [C12095_MINNIE-M](#) [C12097_MINNIE-WWW](#) [C12154_LENA-M](#) [C12469_LISA2-R-](#)
[PIN](#) [C12476_MIRELLA-50-S](#) [C12477_MIRELLA-50-M](#) [C12480_MIRELLA-50-S-PIN](#) [C12516_RITA-WAS](#) [C12597_LENINA-S](#)
[C12599_LENINA-W](#) [C12948_LENA-WAS](#) [C12958_LENINA-XW](#) [C13085_MIRELLA-50-S-PF](#) [C13087_MIRELLA-50-W-PF](#)
[C13101_LENA-X-WAS](#) [C13555_BRIDGET-W-UNI](#) [C13556_BRIDGET-M-UNI](#) [C13557_BRIDGET-S-UNI](#) [C14346_ANGELETTE-WAS](#)
[C17099_ALISE-50-DL](#) [C17095_ALISE-70-CL](#)