

ANNA-40-7-WW

~65° wide beam with 7 optics

TECHNICAL SPECIFICATIONS:

Dimensions	Ø 40.0 mm
Height	12.2 mm
Fastening	pin
ROHS compliant	yes ⓘ

MATERIAL SPECIFICATIONS:

Component	Type	Material	Colour	Finish
ANNA-40-7-WW	Multi-lens	PMMA	clear	



ORDERING INFORMATION:

Component	Qty in box	MOQ	MPQ	Box weight (kg)
C13413_ANNA-40-7-WW » Box size: 480 x 280 x 300 mm	760	120	40	9.0

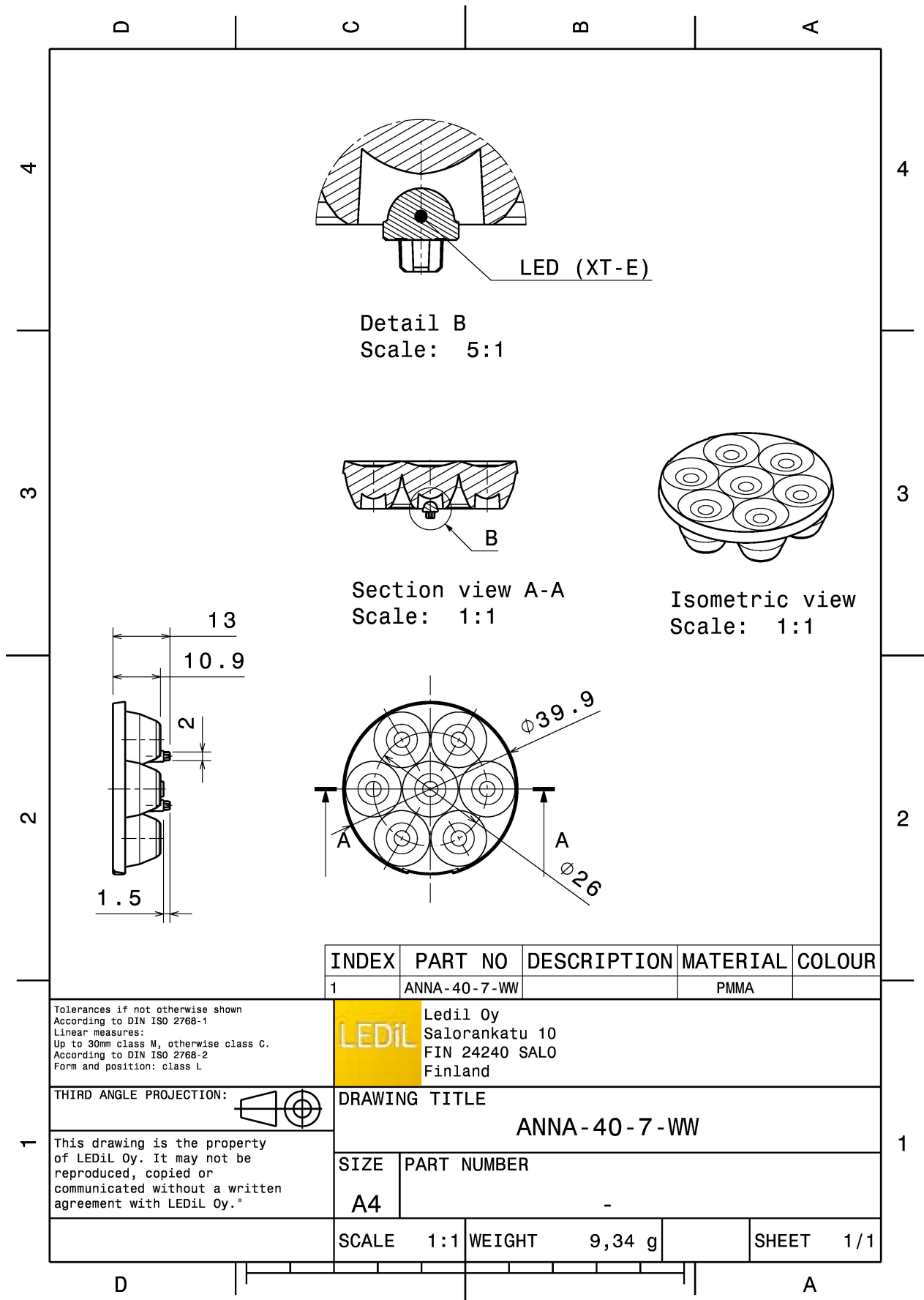

INDEX	PART NO	DESCRIPTION	MATERIAL	COLOUR
1	ANNA-40-7-WW		PMMA	

Tolerances if not otherwise shown
According to DIN ISO 2768-1
Linear measures:
Up to 30mm class M, otherwise class C.
According to DIN ISO 2768-2
Form and position: class L

LEDiL Ledil Oy
Salorankatu 10
FIN 24240 SALO
Finland

THIRD ANGLE PROJECTION:

DRAWING TITLE
ANNA-40-7-WW

This drawing is the property of LEDiL Oy. It may not be reproduced, copied or communicated without a written agreement with LEDiL Oy."

SIZE	PART NUMBER
A4	-

SCALE	1:1	WEIGHT	9,34 g	SHEET	1/1
-------	-----	--------	--------	-------	-----

See also our general installation guide: www.ledil.com/installation_guide

PHOTOMETRIC DATA (SIMULATED):



LED J Series 2835
 FWHM / FWTM 66.0° / 84.0°
 Efficiency 96 %
 Peak intensity 1 cd/lm
 LEDs/each optic 1
 Light colour White
 Required components:

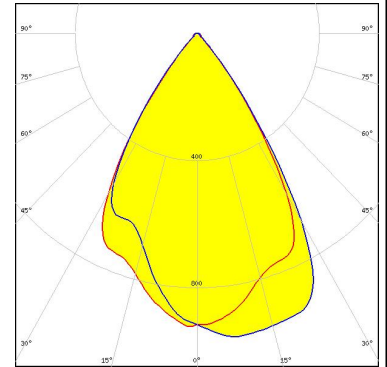

LED XB-D
 FWHM / FWTM 69.0° / 90.0°
 Efficiency 92 %
 Peak intensity 0.8 cd/lm
 LEDs/each optic 1
 Light colour White
 Required components:

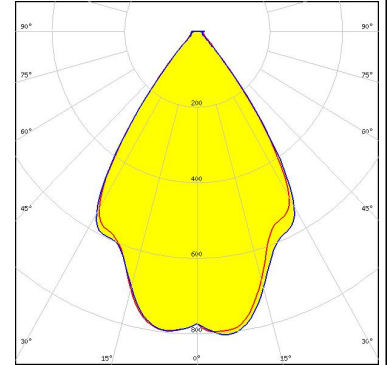

LED XP-G3
 FWHM / FWTM 74.0° / 96.0°
 Efficiency 92 %
 Peak intensity 0.7 cd/lm
 LEDs/each optic 1
 Light colour White
 Required components:

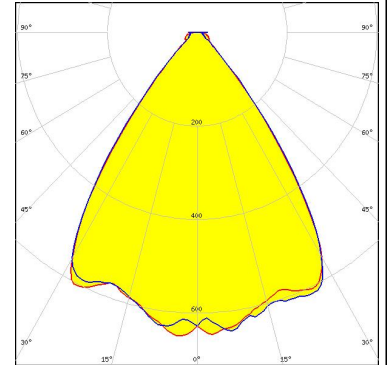

LED XT-E
 FWHM / FWTM 67.0° / 82.0°
 Efficiency 84 %
 Peak intensity 0.8 cd/lm
 LEDs/each optic 1
 Light colour White
 Required components:

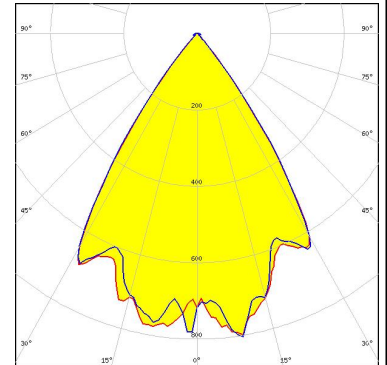

PHOTOMETRIC DATA (SIMULATED):

LUMILEDS

LED LUXEON A
 FWHM / FWTM 69.0° / 84.0°
 Efficiency 86 %
 Peak intensity 0.8 cd/lm
 LEDs/each optic 1
 Light colour White
 Required components:

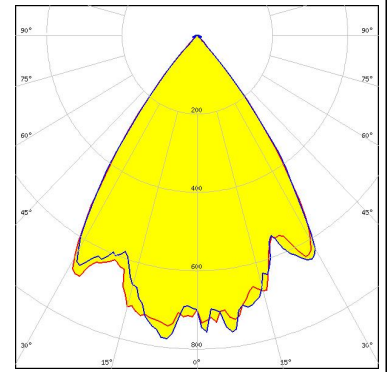

LUMILEDS

LED LUXEON R
 FWHM / FWTM 68.0° / 83.0°
 Efficiency 88 %
 Peak intensity 0.8 cd/lm
 LEDs/each optic 1
 Light colour White
 Required components:

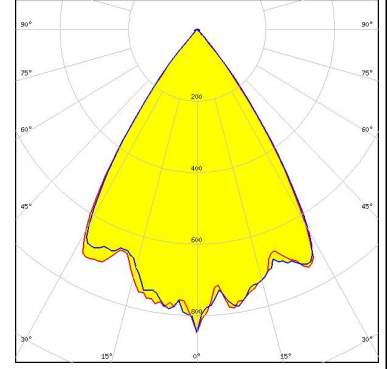

LUMILEDS

LED LUXEON Rebel ES
 FWHM / FWTM 68.0° / 82.0°
 Efficiency 89 %
 Peak intensity 0.9 cd/lm
 LEDs/each optic 1
 Light colour White
 Required components:

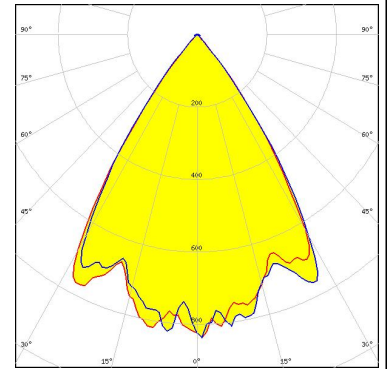

LUMILEDS

LED LUXEON T
 FWHM / FWTM 69.0° / 83.0°
 Efficiency 88 %
 Peak intensity 0.8 cd/lm
 LEDs/each optic 1
 Light colour White
 Required components:

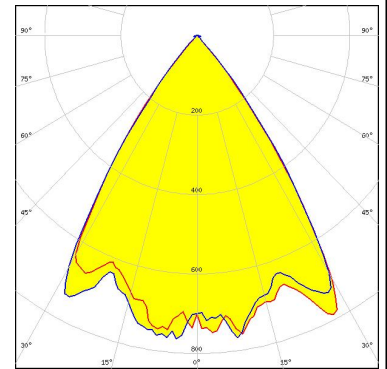

PHOTOMETRIC DATA (SIMULATED):

<p>LUMILEDS</p> <p>LED: LUXEON TX FWHM / FWTM: 65.0° / 91.0° Efficiency: 91 % Peak intensity: 0.9 cd/lm LEDs/each optic: 1 Light colour: White Required components:</p>	
<p>NICHIA</p> <p>LED: NCSxx19A FWHM / FWTM: 59.0° / 74.0° Efficiency: 88 % Peak intensity: 1.3 cd/lm LEDs/each optic: 1 Light colour: White Required components:</p>	
<p>NICHIA</p> <p>LED: NS9x153 FWHM / FWTM: 64.0° / 82.0° Efficiency: 85 % Peak intensity: 0.7 cd/lm LEDs/each optic: 1 Light colour: White Required components:</p>	
<p>NICHIA</p> <p>LED: NS9x383 FWHM / FWTM: 58.0° / 80.0° Efficiency: 88 % Peak intensity: 1 cd/lm LEDs/each optic: 1 Light colour: White Required components:</p>	

PHOTOMETRIC DATA (SIMULATED):

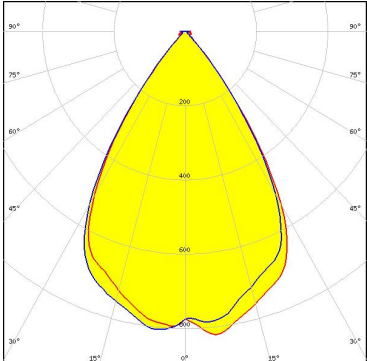
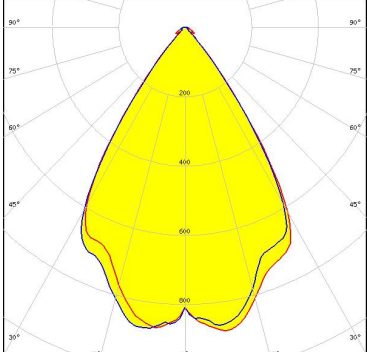
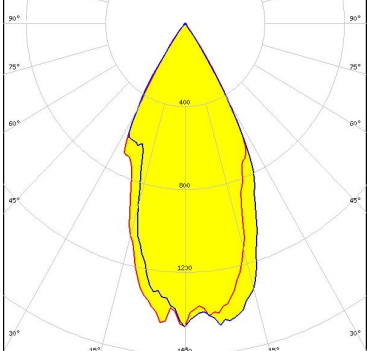
<p>NICHIA</p> <p>LED NVSxx19B/NVSxx19C FWHM / FWTM 66.0° / 85.0° Efficiency 88 % Peak intensity 0.8 cd/lm LEDs/each optic 1 Light colour White Required components:</p>	
<p>OSRAM Opto Semiconductors</p> <p>LED SFH 4726S FWHM / FWTM 68.0° / 84.0° Efficiency 93 % Peak intensity 0.9 cd/lm LEDs/each optic 1 Light colour Red Required components:</p>	
<p>SAMSUNG</p> <p>LED LH351A FWHM / FWTM 45.0° / 69.0° Efficiency 88 % Peak intensity 1.5 cd/lm LEDs/each optic 1 Light colour White Required components:</p>	

GENERAL INFORMATION:

NOTE: The typical beam angle will be changed by different color, chip size and chip position tolerance. The typical total beam angle is the full angle measured where the luminous intensity is half of the peak value.

MATERIALS:

As part of our continuous research and improvement processes, and to ensure the best possible quality and availability of our products, LEDiL reserves the right to change material grades without notice.

PRODUCT DATA USER AGREEMENT AND DISCLAIMER:

The measured data in the provided downloadable LEDiL Product Datasheets and Mechanical 2D-Drawings is rounded and provided as reference for planning. LEDiL Oy's optical specifications have been verified by conducting performance testing of the products in accordance with the company's quality system. The reported data are averaged results of multiple measurements with typical variation. LEDiL Oy reserves the right to without prior notification make changes and improvements to its products.

LEDiL Oy assumes neither warranty, nor guarantee nor any other liability of any kind for the contents and correctness of the provided data. The provided data has been generated with highest diligence but the provided data may in reality not represent the complete possible variation range of all intrinsic parameters. Therefore, in certain cases a deviation from the provided data could occur.

LEDiL Oy reserves the right to undertake technical changes of its products without further notification which could lead to changes in the provided data. LEDiL Oy assumes no liability of any kind for the possible deviation from any provided data or any other damage resulting from the usage of the provided data.

The user agrees to this disclaimer and user agreement with the download or usage of the provided files.

LEDiL Oy

Joensuunkatu 13
FI-24240 SALO
Finland

LEDiL Inc.

228 West Page Street
Suite D
Sycamore IL 60178
USA

Ledil Optics Technology (Shenzhen) Co., Ltd.

405 , Block B
Casic Motor Building
Shenzhen 518057
P.R.CHINA

Local sales and technical support

[www.ledil.com/
where_to_buy](http://www.ledil.com/where_to_buy)

Shipping locations

Salo, Finland
Hong Kong, China

Distribution Partners

[www.ledil.com/
where_to_buy](http://www.ledil.com/where_to_buy)

X-ON Electronics

Largest Supplier of Electrical and Electronic Components

Click to view similar products for [LED Lighting Lenses](#) category:

Click to view products by [Ledil](#) manufacturer:

Other Similar products are found below :

[LL01ED-AK40L06](#) [LL01ZZ-EX25L06-M2](#) [180182-0000](#) [LL01ED-ALI55R49](#) [C14707_IDA16-O](#) [C12231_LENA-FRESNEL-LENS](#)
[LL01ED-AKY24R49](#) [LL01CR-AYG15R49](#) [LL01CR-OT32L06-M2](#) [LL01ZZ-AAA24L49](#) [LL01CR-CEN38L02](#) [LL01ZZ-AAA55L49](#)
[LL01CR-AYG24R49](#) [LL01A00CZMB2-M2](#) [LL01ED-AKY38R49](#) [LL01CR-CNE2545L06-M2](#) [LL01ZZ-AAA38L49](#) [LL01ED-AKV36R49](#)
[LL01ED-ALI24R49](#) [LL01CR-AYG38R49](#) [C17171_DAISSY-8X1-SHD-MATT](#) [F16859_LINDA-ZT25](#) [C17295_ILONA-ZOOM](#)
[F16636_LINDA-W60](#) [C17362_DAISSY-7X1-W-D](#) [C17361_DAISSY-7X1-WW-D](#) [10003](#) [10003/15](#) [10048](#) [10049](#) [10108](#) [10510](#)
[F14487_FLORENCE-1R-MAXI-WG](#) [12667](#) [C14165_STRADA-2X2-ME-WIDE2](#) [C14605_HB-2X2-RW](#) [C14642_FLORENCE-1R-UP](#)
[CAY033](#) [CAY046/55](#) [FCX11157_RES-O-90](#) [OS-LRI2015X45S](#) [OSOLRA2015M](#) [PG1C-NX36](#) [PG1C-SX17](#) [PM2A-SXV1](#) [PM2B-NX55-](#)
[AW](#) [PM6A-FN25](#) [FC2231-0000-0050-L](#) [FC2231-0000-0100-L](#) [C14116_STRADA-2X2-PX](#)