

ANNA-40-7-S

~15° spot beam with 7 optics

TECHNICAL SPECIFICATIONS:

Dimensions	Ø 40.0 mm
Height	10.7 mm
Fastening	pin
ROHS compliant	yes ⓘ

MATERIAL SPECIFICATIONS:

Component	Type	Material	Colour	Finish
ANNA-40-7-S	Multi-lens	PMMA	clear	



ORDERING INFORMATION:

Component	Qty in box	MOQ	MPQ	Box weight (kg)
C13483_ANNA-40-7-S » Box size: 480 x 280 x 300 mm	760	120	40	8.2

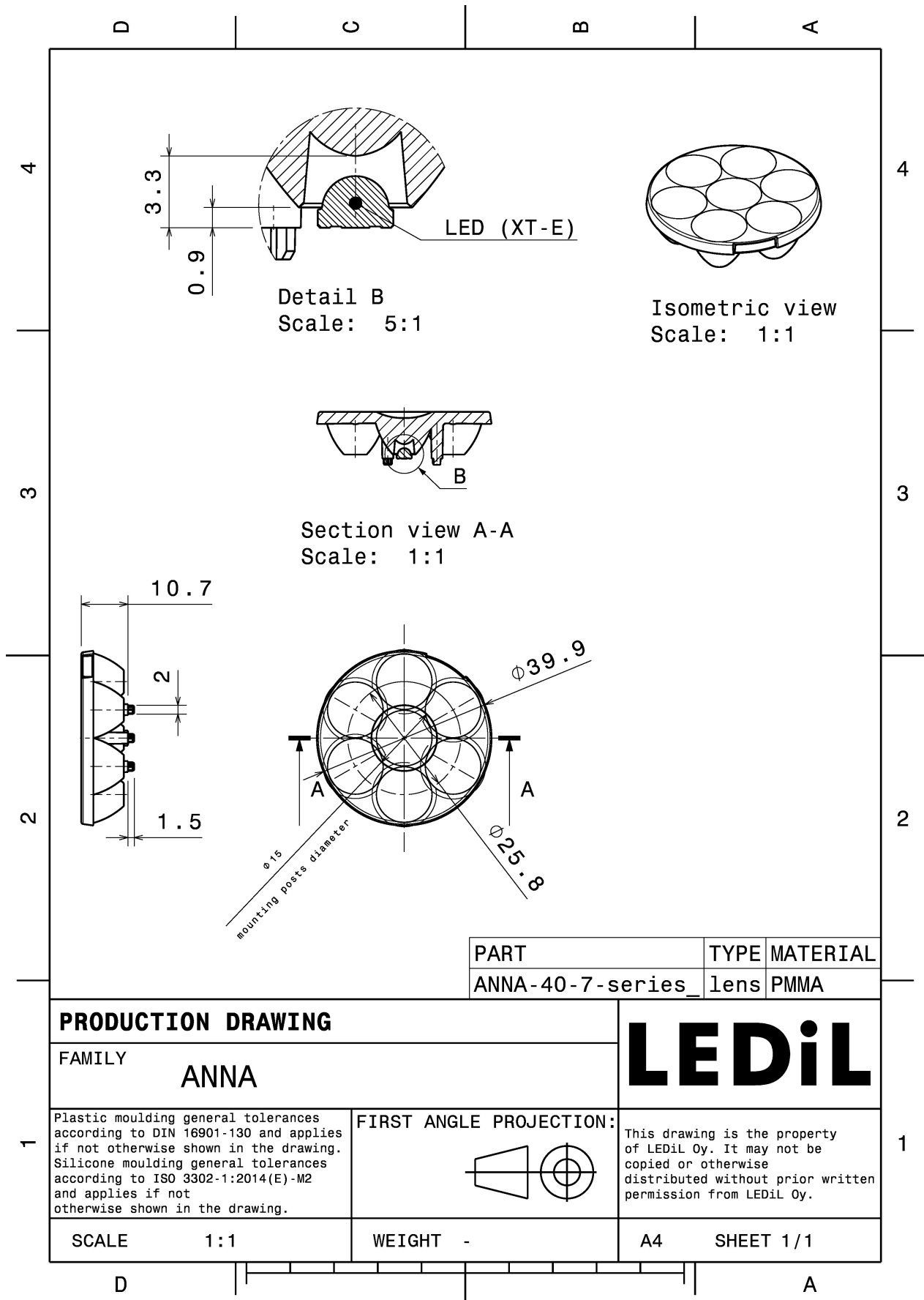

PART	TYPE	MATERIAL
ANNA-40-7-series_	lens	PMMA

PRODUCTION DRAWING

FAMILY
ANNA

LEDiL

Plastic moulding general tolerances according to DIN 16901-130 and applies if not otherwise shown in the drawing. Silicone moulding general tolerances according to ISO 3302-1:2014(E)-M2 and applies if not otherwise shown in the drawing.

FIRST ANGLE PROJECTION:

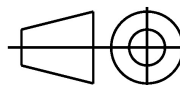

This drawing is the property of LEDiL Oy. It may not be copied or otherwise distributed without prior written permission from LEDiL Oy.

SCALE 1:1

WEIGHT -

A4 SHEET 1/1

See also our general installation guide: www.ledil.com/installation_guide

PHOTOMETRIC DATA (MEASURED):

CREE LED

LED XP-E2
 FWHM / FWTM 12.0° / 24.5°
 Efficiency 87 %
 Peak intensity 13.8 cd/lm
 LEDs/each optic 1
 Light colour White
 Required components:

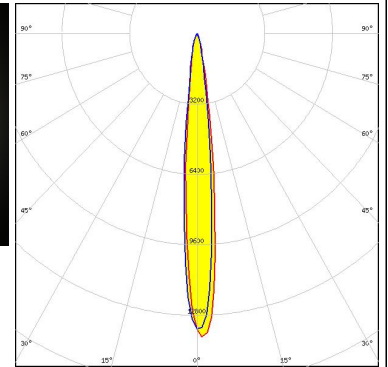

CREE LED

LED XP-G2
 FWHM / FWTM 17.0° / 33.0°
 Efficiency 91 %
 Peak intensity 7.6 cd/lm
 LEDs/each optic 1
 Light colour White
 Required components:

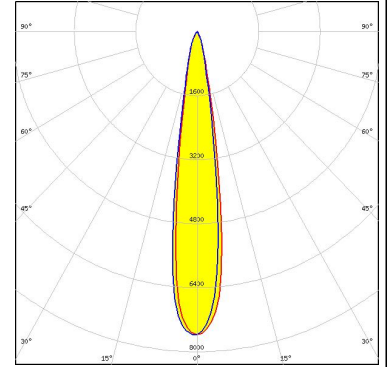





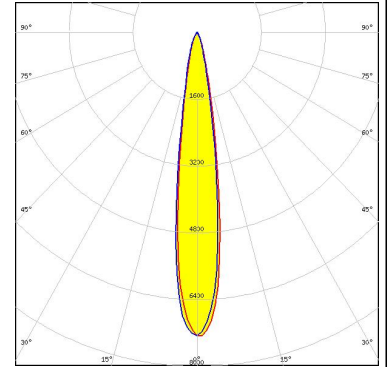

CREE LED

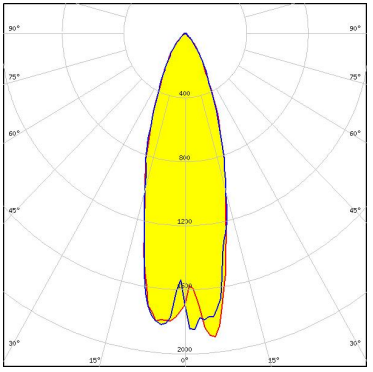
LED XT-E
 FWHM / FWTM 16.0° / 33.0°
 Efficiency 89 %
 Peak intensity 7.3 cd/lm
 LEDs/each optic 1
 Light colour White
 Required components:

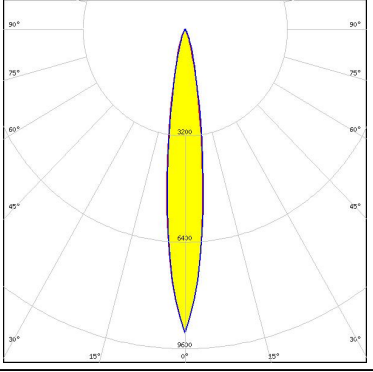

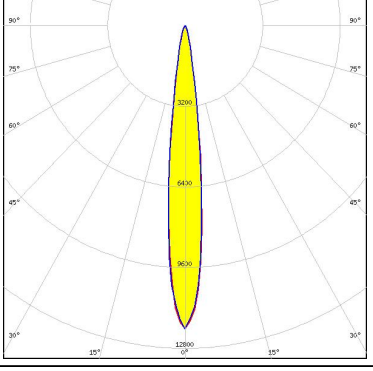
PHOTOMETRIC DATA (SIMULATED):

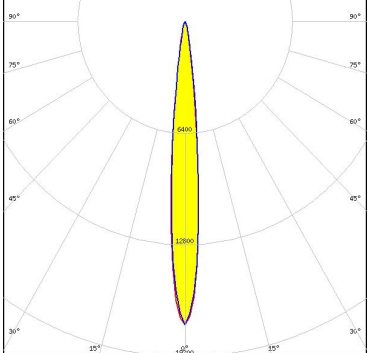
<p></p> <p>LED SM4 FWHM / FWTM 33.0° / 66.0° Efficiency 87 % Peak intensity 2.1 cd/lm LEDs/each optic 1 Light colour White Required components:</p>	
<p></p> <p>LED J Series 2835 FWHM / FWTM 14.0° / 32.0° Efficiency 96 % Peak intensity 9.1 cd/lm LEDs/each optic 1 Light colour White Required components:</p>	
<p></p> <p>LED XB-D White FWHM / FWTM 13.0° / 25.0° Efficiency 90 % Peak intensity 12 cd/lm LEDs/each optic 1 Light colour White Required components:</p>	
<p></p> <p>LED XP-E FWHM / FWTM 11.0° / 21.0° Efficiency 93 % Peak intensity 17.4 cd/lm LEDs/each optic 1 Light colour White Required components:</p>	

PHOTOMETRIC DATA (SIMULATED):

<p>CREE LED</p> <p>LED: XP-G FWHM / FWTM: 15.0° / 30.0° Efficiency: 93 % Peak intensity: 9.3 cd/lm LEDs/each optic: 1 Light colour: White Required components:</p>	
<p>CREE LED</p> <p>LED: XP-L HD FWHM / FWTM: 22.0° / 42.0° Efficiency: 92 % Peak intensity: 4.4 cd/lm LEDs/each optic: 1 Light colour: White Required components:</p>	
<p>LUMILEDS</p> <p>LED: LUXEON PWT FWHM / FWTM: 17.0° / 32.0° Efficiency: 88 % Peak intensity: 7.6 cd/lm LEDs/each optic: 1 Light colour: White Required components:</p>	
<p>LUMILEDS</p> <p>LED: LUXEON T FWHM / FWTM: 17.0° / 31.0° Efficiency: 92 % Peak intensity: 8.5 cd/lm LEDs/each optic: 1 Light colour: White Required components:</p>	

PHOTOMETRIC DATA (SIMULATED):

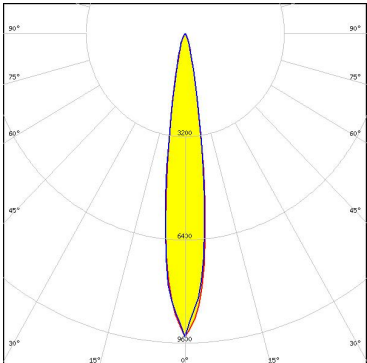
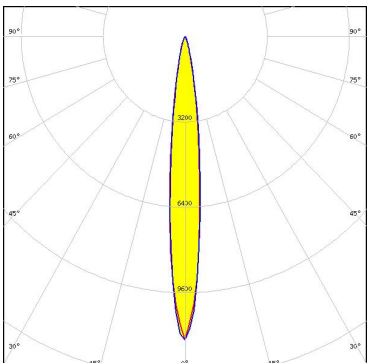
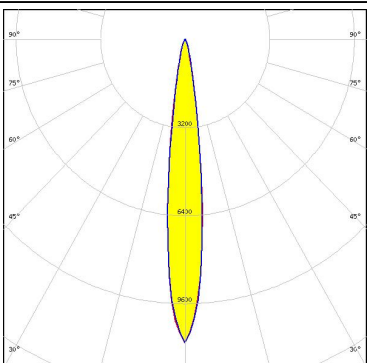
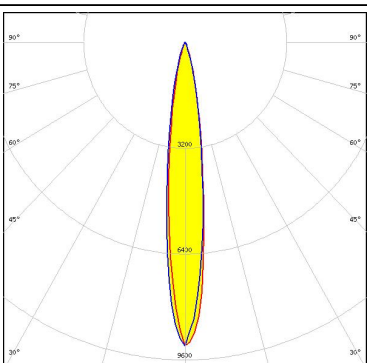
<p>LUMILEDS</p> <p>LED: LUXEON TX FWHM / FWTM: 15.0° / 29.0° Efficiency: 93 % Peak intensity: 9.4 cd/lm LEDs/each optic: 1 Light colour: White Required components:</p>	
<p>NICHIA</p> <p>LED: NCSxx19A FWHM / FWTM: 17.0° / 30.0° Efficiency: 87 % Peak intensity: 7.7 cd/lm LEDs/each optic: 1 Light colour: White Required components:</p>	
<p>NICHIA</p> <p>LED: NCSxx19B FWHM / FWTM: 14.0° / 27.0° Efficiency: 95 % Peak intensity: 11 cd/lm LEDs/each optic: 1 Light colour: White Required components:</p>	
<p>NICHIA</p> <p>LED: NF2x757A FWHM / FWTM: 14.0° / 32.0° Efficiency: 92 % Peak intensity: 9.2 cd/lm LEDs/each optic: 1 Light colour: White Required components:</p>	

PHOTOMETRIC DATA (SIMULATED):

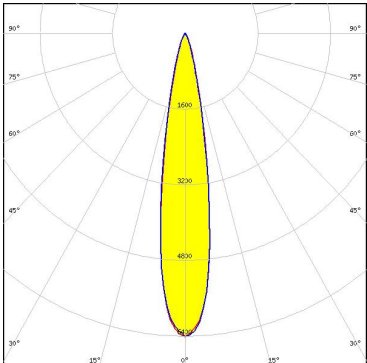
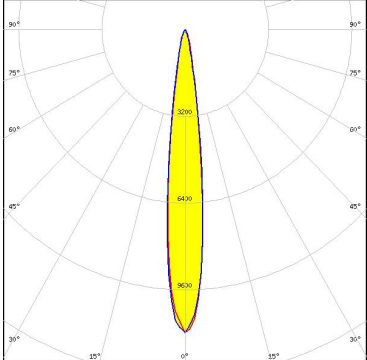
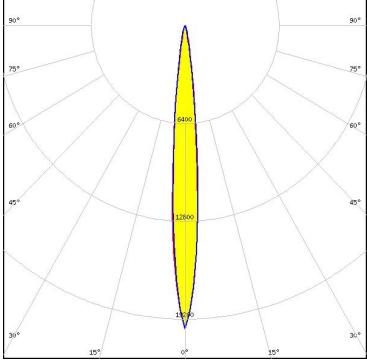
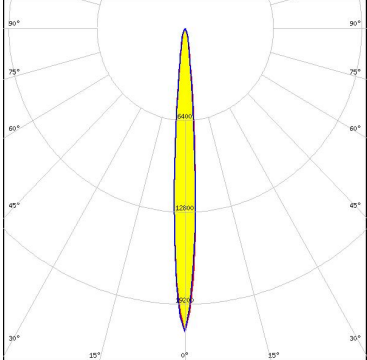
<p>NICHIA</p> <p>LED NVSxx19B/NVSxx19C</p> <p>FWHM / FWTM 18.0° / 35.0°</p> <p>Efficiency 92 %</p> <p>Peak intensity 6.3 cd/lm</p> <p>LEDs/each optic 1</p> <p>Light colour White</p> <p>Required components:</p>	
<p>OSRAM Opto Semiconductors</p> <p>LED OSLOM Square EC</p> <p>FWHM / FWTM 13.0° / 27.0°</p> <p>Efficiency 92 %</p> <p>Peak intensity 11.2 cd/lm</p> <p>LEDs/each optic 1</p> <p>Light colour White</p> <p>Required components:</p>	
<p>OSRAM Opto Semiconductors</p> <p>LED OSLOM SSL 150</p> <p>FWHM / FWTM 10.0° / 21.0°</p> <p>Efficiency 92 %</p> <p>Peak intensity 19.8 cd/lm</p> <p>LEDs/each optic 1</p> <p>Light colour White</p> <p>Required components:</p>	
<p>OSRAM Opto Semiconductors</p> <p>LED OSLOM SSL 80</p> <p>FWHM / FWTM 8.0° / 19.0°</p> <p>Efficiency %</p> <p>Peak intensity 21.1 cd/lm</p> <p>LEDs/each optic 1</p> <p>Light colour White</p> <p>Required components:</p>	

PHOTOMETRIC DATA (SIMULATED):

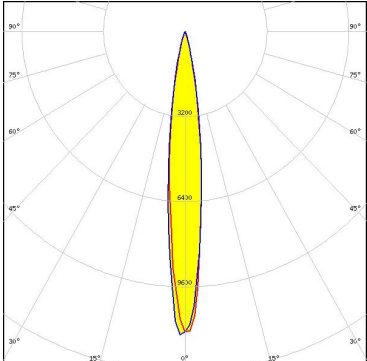
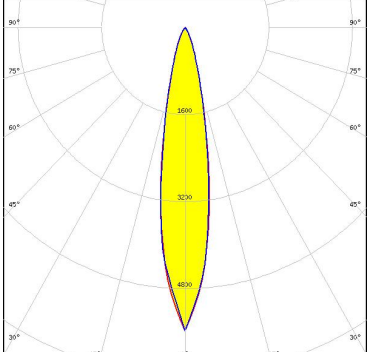
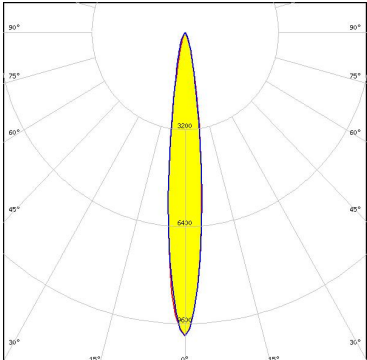
<p>OSRAM Opto Semiconductors</p> <p>LED SFH 4715S FWHM / FWTM 13.0° / 28.0° Efficiency 90 % Peak intensity 11.7 cd/lm LEDs/each optic 1 Light colour White Required components:</p>	
<p>SEOLUX SEOUL SEMICONDUCTOR</p> <p>LED Z8Y22P FWHM / FWTM 18.0° Efficiency 90 % Peak intensity 5.5 cd/lm LEDs/each optic 1 Light colour White Required components:</p>	
<p>SHARP</p> <p>LED Double Dome (GM2BB) FWHM / FWTM 13.0° / 29.0° Efficiency 89 % Peak intensity 10 cd/lm LEDs/each optic 1 Light colour White Required components:</p>	

GENERAL INFORMATION:

NOTE: The typical beam angle will be changed by different color, chip size and chip position tolerance. The typical total beam angle is the full angle measured where the luminous intensity is half of the peak value.

MATERIALS:

As part of our continuous research and improvement processes, and to ensure the best possible quality and availability of our products, LEDiL reserves the right to change material grades without notice.

PRODUCT DATA USER AGREEMENT AND DISCLAIMER:

The measured data in the provided downloadable LEDiL Product Datasheets and Mechanical 2D-Drawings is rounded and provided as reference for planning. LEDiL Oy's optical specifications have been verified by conducting performance testing of the products in accordance with the company's quality system. The reported data are averaged results of multiple measurements with typical variation. LEDiL Oy reserves the right to without prior notification make changes and improvements to its products.

LEDiL Oy assumes neither warranty, nor guarantee nor any other liability of any kind for the contents and correctness of the provided data. The provided data has been generated with highest diligence but the provided data may in reality not represent the complete possible variation range of all intrinsic parameters. Therefore, in certain cases a deviation from the provided data could occur.

LEDiL Oy reserves the right to undertake technical changes of its products without further notification which could lead to changes in the provided data. LEDiL Oy assumes no liability of any kind for the possible deviation from any provided data or any other damage resulting from the usage of the provided data.

The user agrees to this disclaimer and user agreement with the download or usage of the provided files.

LEDiL Oy

Joensuunkatu 13
FI-24240 SALO
Finland

LEDiL Inc.

228 West Page Street
Suite D
Sycamore IL 60178
USA

Ledil Optics Technology (Shenzhen) Co., Ltd.

405 , Block B
Casic Motor Building
Shenzhen 518057
P.R.CHINA

Local sales and technical support

[www.ledil.com/
where_to_buy](http://www.ledil.com/where_to_buy)

Shipping locations

Salo, Finland
Hong Kong, China

Distribution Partners

[www.ledil.com/
where_to_buy](http://www.ledil.com/where_to_buy)

X-ON Electronics

Largest Supplier of Electrical and Electronic Components

Click to view similar products for [LED Lighting Lenses](#) category:

Click to view products by [Ledil](#) manufacturer:

Other Similar products are found below :

[LL01ED-AK40L06](#) [LL01ZZ-EX25L06-M2](#) [180182-0000](#) [LL01ED-ALI55R49](#) [C14707_IDA16-O](#) [C12231_LENA-FRESNEL-LENS](#)
[LL01ED-AKY24R49](#) [LL01CR-AYG15R49](#) [LL01CR-OT32L06-M2](#) [LL01ZZ-AAA24L49](#) [LL01CR-CEN38L02](#) [LL01ZZ-AAA55L49](#)
[LL01CR-AYG24R49](#) [LL01A00CZMB2-M2](#) [LL01ED-AKY38R49](#) [LL01CR-CNE2545L06-M2](#) [LL01ZZ-AAA38L49](#) [LL01ED-AKV36R49](#)
[LL01ED-ALI24R49](#) [LL01CR-AYG38R49](#) [C17171_DAISSY-8X1-SHD-MATT](#) [F16859_LINDA-ZT25](#) [C17295_ILONA-ZOOM](#)
[F16636_LINDA-W60](#) [C17362_DAISSY-7X1-W-D](#) [C17361_DAISSY-7X1-WW-D](#) [10003](#) [10003/15](#) [10048](#) [10049](#) [10108](#) [10510](#)
[F14487_FLORENCE-1R-MAXI-WG](#) [12667](#) [C14165_STRADA-2X2-ME-WIDE2](#) [C14605_HB-2X2-RW](#) [C14642_FLORENCE-1R-UP](#)
[CAY033](#) [CAY046/55](#) [FCX11157_RES-O-90](#) [OS-LRI2015X45S](#) [OSOLRA2015M](#) [PG1C-NX36](#) [PG1C-SX17](#) [PM2A-SXV1](#) [PM2B-NX55-](#)
[AW](#) [PM6A-FN25](#) [FC2231-0000-0050-L](#) [FC2231-0000-0100-L](#) [C14116_STRADA-2X2-PX](#)