

VERONICA-RS

~12° spot beam

TECHNICAL SPECIFICATIONS:

Dimensions	Ø 26.0 mm
Height	12.2 mm
Fastening	glue, pin
ROHS compliant	yes ⓘ

MATERIAL SPECIFICATIONS:

Component	Type	Material	Colour	Finish
VERONICA-RS	Single lens	PMMA	clear	







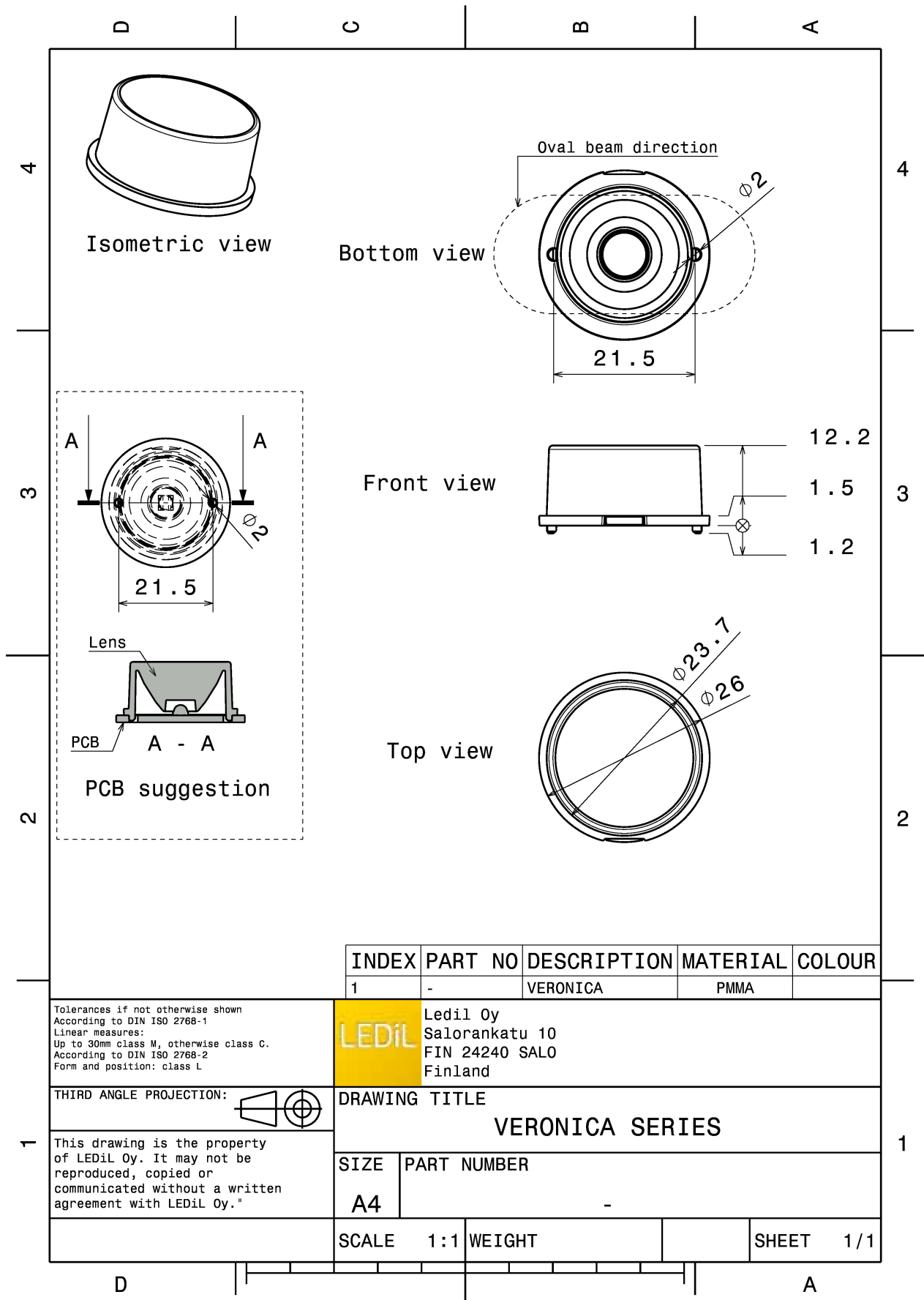

ORDERING INFORMATION:

Component	Qty in box	MOQ	MPQ	Box weight (kg)
C13528_VERONICA-RS » Box size: 480 x 280 x 300 mm	2240	336	112	11.1

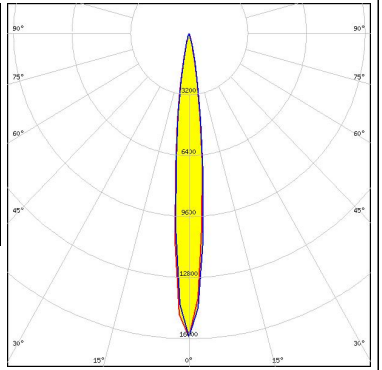

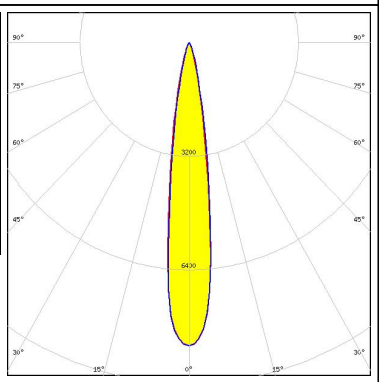
See also our general installation guide: www.ledil.com/installation_guide

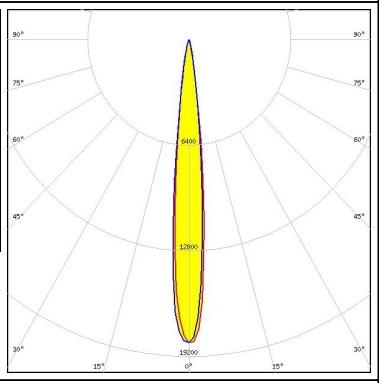
PHOTOMETRIC DATA (MEASURED):

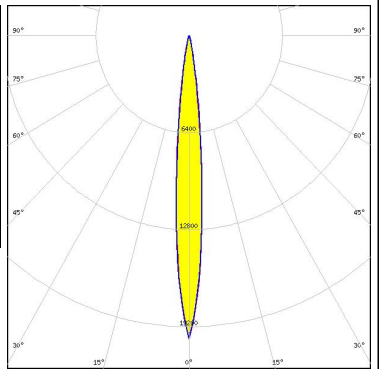
<p>CREE → LED</p> <p>LED XB-H FWHM / FWTM 11.0° / 24.0° Efficiency 89 % Peak intensity 15.9 cd/lm LEDs/each optic 1 Light colour White Required components:</p>		
<p>CREE → LED</p> <p>LED XM-L2 FWHM / FWTM 16.0° / 32.0° Efficiency 90 % Peak intensity 8.5 cd/lm LEDs/each optic 1 Light colour White Required components:</p>		
<p>CREE → LED</p> <p>LED XP-G FWHM / FWTM 12.0° / 22.0° Efficiency 90 % Peak intensity 18.4 cd/lm LEDs/each optic 1 Light colour White Required components:</p>		
<p>CREE → LED</p> <p>LED XP-G2 FWHM / FWTM 10.0° / 21.0° Efficiency 90 % Peak intensity 19 cd/lm LEDs/each optic 1 Light colour White Required components:</p>		

PHOTOMETRIC DATA (MEASURED):

LUMILEDS

LED LUXEON A
 FWHM / FWTM 13.0° / 25.0°
 Efficiency 89 %
 Peak intensity 14.7 cd/lm
 LEDs/each optic 1
 Light colour White
 Required components:

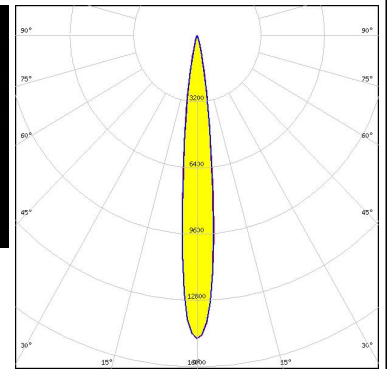

LUMILEDS

LED LUXEON Rebel
 FWHM / FWTM 12.0° / 25.0°
 Efficiency 88 %
 Peak intensity 14.9 cd/lm
 LEDs/each optic 1
 Light colour White
 Required components:

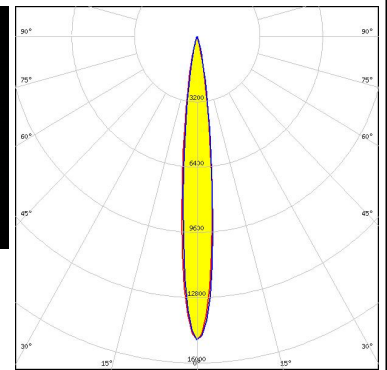

LUMILEDS

LED LUXEON V2
 FWHM / FWTM 12.0° / 25.0°
 Efficiency 94 %
 Peak intensity 13.5 cd/lm
 LEDs/each optic 1
 Light colour White
 Required components:

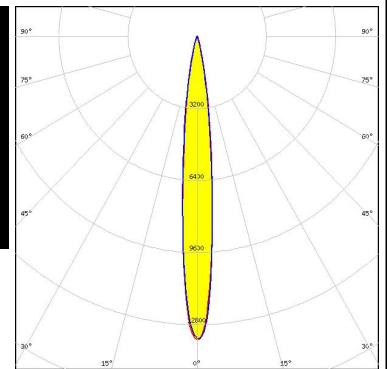

NICHIA

LED NCSxx19A
 FWHM / FWTM 13.0° / 25.0°
 Efficiency 86 %
 Peak intensity 15 cd/lm
 LEDs/each optic 1
 Light colour White
 Required components:

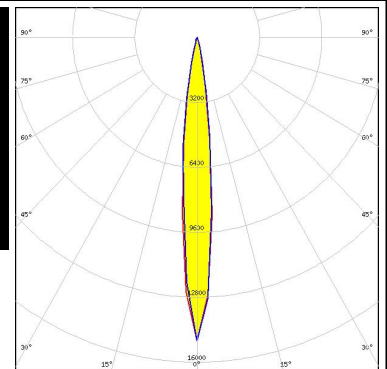

PHOTOMETRIC DATA (MEASURED):



LED NVSW219F
 FWHM / FWTM 13.0° / 24.0°
 Efficiency 94 %
 Peak intensity 13.3 cd/lm
 LEDs/each optic 1
 Light colour White
 Required components:

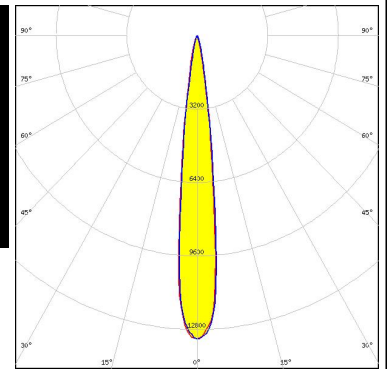

LED NVSW3x9A
 FWHM / FWTM 13.0° / 28.0°
 Efficiency 89 %
 Peak intensity 10.3 cd/lm
 LEDs/each optic 1
 Light colour White
 Required components:

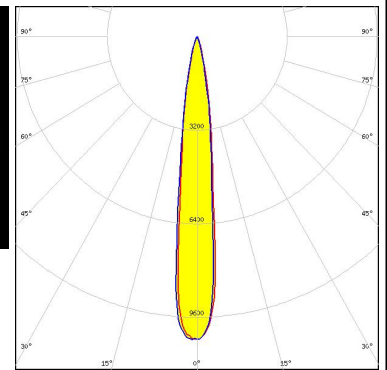

LED NVSxx19A
 FWHM / FWTM 14.0° / 31.0°
 Efficiency 85 %
 Peak intensity 10 cd/lm
 LEDs/each optic 1
 Light colour White
 Required components:

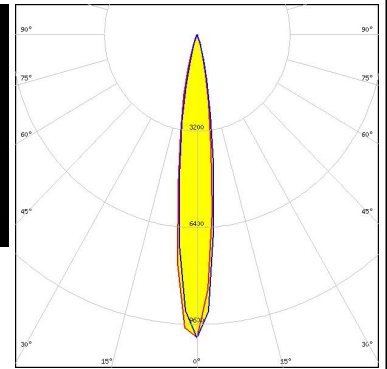
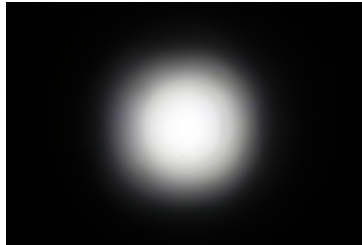

LED NVSxx19B/NVSxx19C
 FWHM / FWTM 13.0° / 28.0°
 Efficiency 87 %
 Peak intensity 12.2 cd/lm
 LEDs/each optic 1
 Light colour White
 Required components:

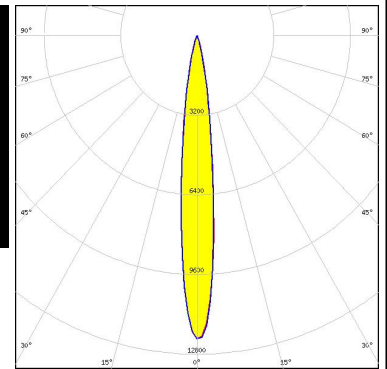

PHOTOMETRIC DATA (MEASURED):

SAMSUNG

LED LH351Z
 FWHM / FWTM 11.0° / 21.0°
 Efficiency 89 %
 Peak intensity 19.9 cd/lm
 LEDs/each optic 1
 Light colour White
 Required components:

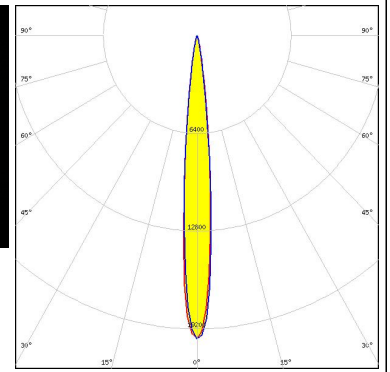

SEOUL SEMICONDUCTOR

LED Z8Y22P
 FWHM / FWTM 11.0° / 29.0°
 Efficiency 87 %
 Peak intensity 10.4 cd/lm
 LEDs/each optic 1
 Light colour White
 Required components:

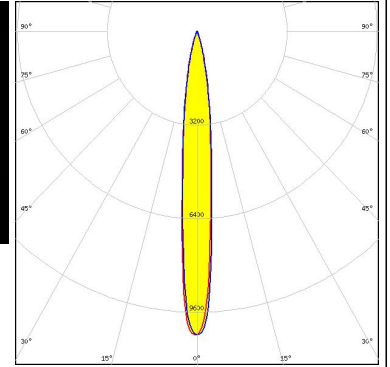
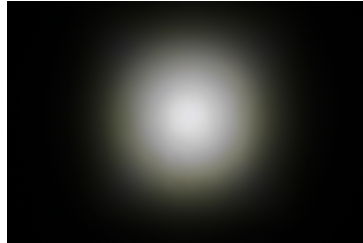

PHOTOMETRIC DATA (SIMULATED):

<p>CREE LED</p> <p>LED: XP-G2 HE FWHM / FWTM: 14.0° / 26.0° Efficiency: 97 % Peak intensity: 12.6 cd/lm LEDs/each optic: 1 Light colour: White Required components:</p>	
<p>NICHIA</p> <p>LED: NCSxE17A FWHM / FWTM: 8.0° / 18.0° Efficiency: 94 % Peak intensity: 28.8 cd/lm LEDs/each optic: 1 Light colour: White Required components:</p>	
<p>NICHIA</p> <p>LED: NV4WB35AM FWHM / FWTM: 18.0° / 31.0° Efficiency: 96 % Peak intensity: 8 cd/lm LEDs/each optic: 1 Light colour: White Required components:</p>	
<p>NICHIA</p> <p>LED: NV4WB35AM FWHM / FWTM: 18.0° / 31.0° Efficiency: 97 % Peak intensity: 8.1 cd/lm LEDs/each optic: 1 Light colour: White Required components:</p>	

PHOTOMETRIC DATA (SIMULATED):

<p>NICHIA</p> <p>LED: NVSW519A FWHM / FWTM: 16.0 + 15.0° / 30.0 + 29.0° Efficiency: 95 % Peak intensity: 9.2 cd/lm LEDs/each optic: 1 Light colour: White Required components:</p>	
<p>NICHIA</p> <p>LED: NVSxE21A FWHM / FWTM: 10.0° / 21.0° Efficiency: 95 % Peak intensity: 20.5 cd/lm LEDs/each optic: 1 Light colour: White Required components:</p>	
<p>OSRAM <small>Opto Semiconductors</small></p> <p>LED: OSCONIQ P 3737 (3W version) FWHM / FWTM: 15.0° / 28.0° Efficiency: 94 % Peak intensity: 10.5 cd/lm LEDs/each optic: 1 Light colour: White Required components:</p>	
<p>OSRAM <small>Opto Semiconductors</small></p> <p>LED: OSOLON Square CSSRM2/CSSRM3 FWHM / FWTM: 9.9° / 20.0° Efficiency: 94 % Peak intensity: 21.3 cd/lm LEDs/each optic: 1 Light colour: White Required components:</p>	

PHOTOMETRIC DATA (SIMULATED):

SAMSUNG

LED LH351B
 FWHM / FWTM 12.0°
 Efficiency %
 LEDs/each optic 1
 Light colour White
 Required components:



SEOUL SEMICONDUCTOR

LED MJT 3030
 FWHM / FWTM 10.0° / 20.0°
 Efficiency 96 %
 Peak intensity 22.1 cd/lm
 LEDs/each optic 1
 Light colour White
 Required components:

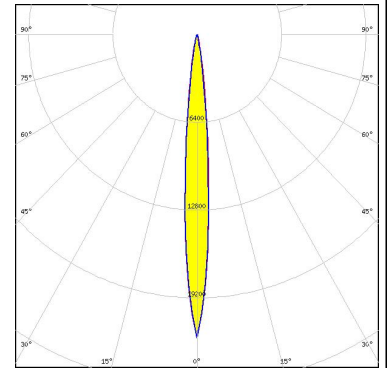

SEOUL SEMICONDUCTOR

LED Z5M4
 FWHM / FWTM 14.0° / 26.0°
 Efficiency 96 %
 Peak intensity 12.9 cd/lm
 LEDs/each optic 1
 Light colour White
 Required components:

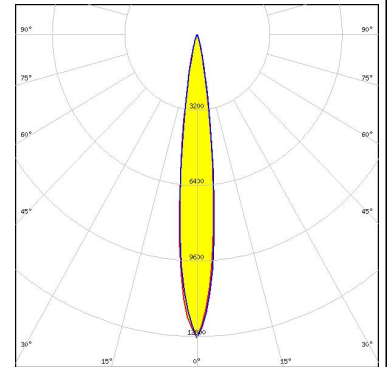

GENERAL INFORMATION:

NOTE: The typical beam angle will be changed by different color, chip size and chip position tolerance. The typical total beam angle is the full angle measured where the luminous intensity is half of the peak value.

MATERIALS:

As part of our continuous research and improvement processes, and to ensure the best possible quality and availability of our products, LEDiL reserves the right to change material grades without notice.

PRODUCT DATA USER AGREEMENT AND DISCLAIMER:

The measured data in the provided downloadable LEDiL Product Datasheets and Mechanical 2D-Drawings is rounded and provided as reference for planning. LEDiL Oy's optical specifications have been verified by conducting performance testing of the products in accordance with the company's quality system. The reported data are averaged results of multiple measurements with typical variation. LEDiL Oy reserves the right to without prior notification make changes and improvements to its products.

LEDiL Oy assumes neither warranty, nor guarantee nor any other liability of any kind for the contents and correctness of the provided data. The provided data has been generated with highest diligence but the provided data may in reality not represent the complete possible variation range of all intrinsic parameters. Therefore, in certain cases a deviation from the provided data could occur.

LEDiL Oy reserves the right to undertake technical changes of its products without further notification which could lead to changes in the provided data. LEDiL Oy assumes no liability of any kind for the possible deviation from any provided data or any other damage resulting from the usage of the provided data.

The user agrees to this disclaimer and user agreement with the download or usage of the provided files.

LEDiL Oy

Joensuunkatu 13
FI-24240 SALO
Finland

LEDiL Inc.

228 West Page Street
Suite D
Sycamore IL 60178
USA

Ledil Optics Technology (Shenzhen) Co., Ltd.

405 , Block B
Casic Motor Building
Shenzhen 518057
P.R.CHINA

Local sales and technical support

[www.ledil.com/
where_to_buy](http://www.ledil.com/where_to_buy)

Shipping locations

Salo, Finland
Hong Kong, China

Distribution Partners

[www.ledil.com/
where_to_buy](http://www.ledil.com/where_to_buy)

X-ON Electronics

Largest Supplier of Electrical and Electronic Components

Click to view similar products for [LED Lighting Lenses](#) category:

Click to view products by [Ledil](#) manufacturer:

Other Similar products are found below :

[LL01ED-AK40L06](#) [LL01ZZ-EX25L06-M2](#) [180182-0000](#) [LL01ED-ALI55R49](#) [C14707_IDA16-O](#) [C12231_LENA-FRESNEL-LENS](#)
[LL01ED-AKY24R49](#) [LL01CR-AYG15R49](#) [LL01CR-OT32L06-M2](#) [LL01ZZ-AAA24L49](#) [LL01CR-CEN38L02](#) [LL01ZZ-AAA55L49](#)
[LL01CR-AYG24R49](#) [LL01A00CZMB2-M2](#) [LL01ED-AKY38R49](#) [LL01CR-CNE2545L06-M2](#) [LL01ZZ-AAA38L49](#) [LL01ED-AKV36R49](#)
[LL01ED-ALI24R49](#) [LL01CR-AYG38R49](#) [C17171_DAISSY-8X1-SHD-MATT](#) [F16859_LINDA-ZT25](#) [C17295_ILONA-ZOOM](#)
[F16636_LINDA-W60](#) [C17362_DAISSY-7X1-W-D](#) [C17361_DAISSY-7X1-WW-D](#) [10003](#) [10003/15](#) [10048](#) [10049](#) [10108](#) [10510](#)
[F14487_FLORENCE-1R-MAXI-WG](#) [12667](#) [C14165_STRADA-2X2-ME-WIDE2](#) [C14605_HB-2X2-RW](#) [C14642_FLORENCE-1R-UP](#)
[CAY033](#) [CAY046/55](#) [FCX11157_RES-O-90](#) [OS-LRI2015X45S](#) [OSOLRA2015M](#) [PG1C-NX36](#) [PG1C-SX17](#) [PM2A-SXV1](#) [PM2B-NX55-](#)
[AW](#) [PM6A-FN25](#) [FC2231-0000-0050-L](#) [FC2231-0000-0100-L](#) [C14116_STRADA-2X2-PX](#)