

## MELODY-4-M2

~30° medium beam optimized for Nichia NCSW219A with 4 optics

### TECHNICAL SPECIFICATIONS:

Dimensions	Ø 50.6 mm
Height	11.9 mm
Fastening	pin
ROHS compliant	yes ⓘ



### MATERIAL SPECIFICATIONS:

Component	Type	Material	Colour	Finish
MELODY-4-M2	Multi-lens	PMMA	clear	

### ORDERING INFORMATION:

Component	Qty in box	MOQ	MPQ	Box weight (kg)
C14054_MELODY-4-M2 » Box size: 480 x 280 x 300 mm	364	112	28	5.7

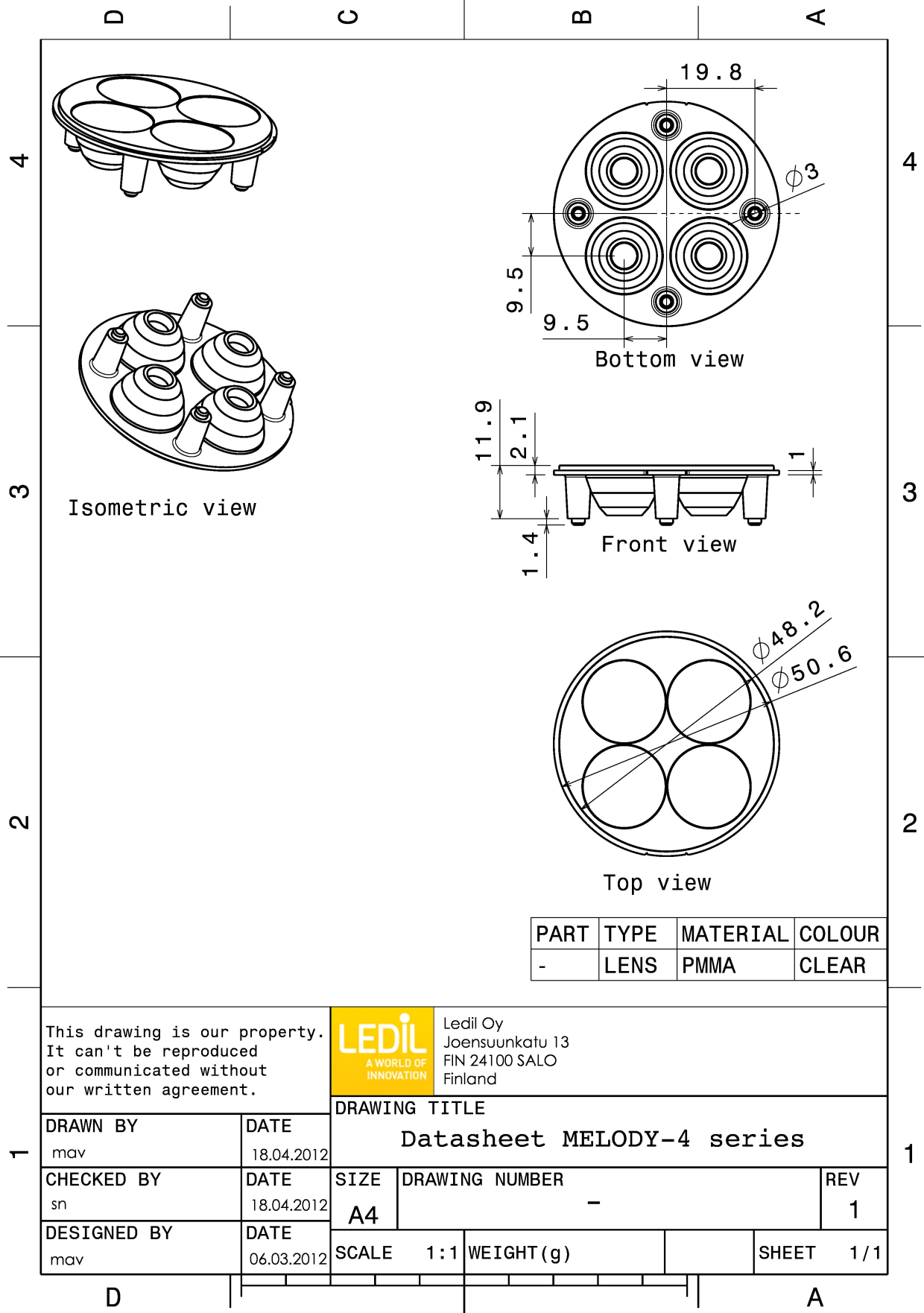

See also our general installation guide: [www.ledil.com/installation\\_guide](http://www.ledil.com/installation_guide)





### PHOTOMETRIC DATA (MEASURED):

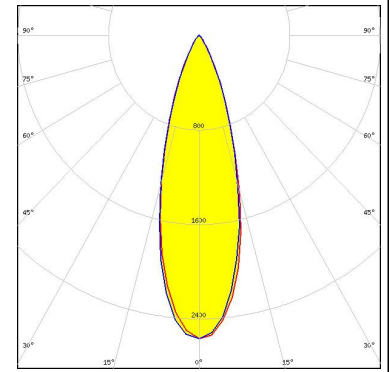

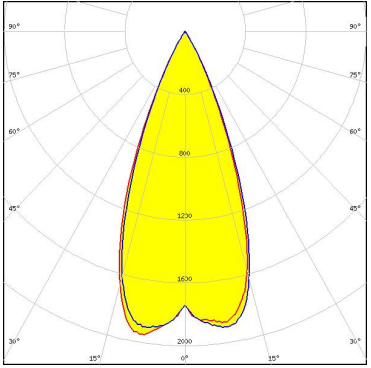

LED LUXEON Z ES  
FWHM 32.0°  
Efficiency 87 %  
Peak intensity 2.6 cd/lm  
LEDs/each optic 1  
Light colour White  
Required components:



### PHOTOMETRIC DATA (SIMULATED):

		
LED	LUXEON T	
FWHM	42.0°	
Efficiency	92 %	
LEDs/each optic	1	
Light colour	White	
Required components:		
		
LED	NCSxx19A	
FWHM	36.0°	
Efficiency	90 %	
LEDs/each optic	1	
Light colour	White	
Required components:		
		
LED	NCSxx19B	
FWHM	36.0°	
Efficiency	92 %	
LEDs/each optic	1	
Light colour	White	
Required components:		
		
LED	NVSxx19A	
FWHM	40.0°	
Efficiency	89 %	
LEDs/each optic	1	
Light colour	White	
Required components:		

### PHOTOMETRIC DATA (SIMULATED):

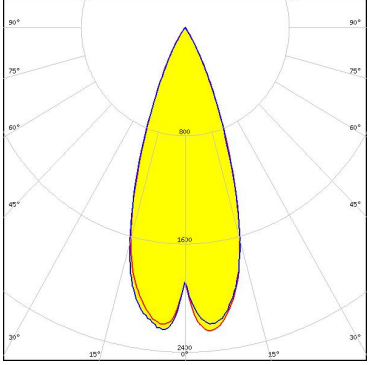
	
LED	NVSxx19B/NVSxx19C
FWHM	41.0°
Efficiency	90 %
LEDs/each optic	1
Light colour	White
Required components:	
	
LED	Z5M
FWHM	38.0°
Efficiency	92 %
LEDs/each optic	1
Light colour	White
Required components:	
	

### GENERAL INFORMATION:

NOTE: The typical beam angle will be changed by different color, chip size and chip position tolerance. The typical total beam angle is the full angle measured where the luminous intensity is half of the peak value.

### MATERIALS:

As part of our continuous research and improvement processes, and to ensure the best possible quality and availability of our products, LEDiL reserves the right to change material grades without notice.

### PRODUCT DATA USER AGREEMENT AND DISCLAIMER:

The measured data in the provided downloadable LEDiL Product Datasheets and Mechanical 2D-Drawings is rounded and provided as reference for planning. LEDiL Oy's optical specifications have been verified by conducting performance testing of the products in accordance with the company's quality system. The reported data are averaged results of multiple measurements with typical variation. LEDiL Oy reserves the right to without prior notification make changes and improvements to its products.

LEDiL Oy assumes neither warranty, nor guarantee nor any other liability of any kind for the contents and correctness of the provided data. The provided data has been generated with highest diligence but the provided data may in reality not represent the complete possible variation range of all intrinsic parameters. Therefore, in certain cases a deviation from the provided data could occur.

LEDiL Oy reserves the right to undertake technical changes of its products without further notification which could lead to changes in the provided data. LEDiL Oy assumes no liability of any kind for the possible deviation from any provided data or any other damage resulting from the usage of the provided data.

The user agrees to this disclaimer and user agreement with the download or usage of the provided files.

#### LEDiL Oy

Joensuunkatu 13  
FI-24240 SALO  
Finland

#### LEDiL Inc.

228 West Page Street  
Suite D  
Sycamore IL 60178  
USA

#### Ledil Optics Technology (Shenzhen) Co., Ltd.

# 405 , Block B  
Casic Motor Building  
Shenzhen 518057  
P.R.CHINA

#### Local sales and technical support

[www.ledil.com/  
where\\_to\\_buy](http://www.ledil.com/where_to_buy)

#### Shipping locations

Salo, Finland  
Hong Kong, China

#### Distribution Partners

[www.ledil.com/  
where\\_to\\_buy](http://www.ledil.com/where_to_buy)

## X-ON Electronics

Largest Supplier of Electrical and Electronic Components

*Click to view similar products for [LED Lighting Lenses](#) category:*

*Click to view products by [Ledil](#) manufacturer:*

Other Similar products are found below :

[LL01ED-AK40L06](#) [LL01ZZ-EX25L06-M2](#) [180182-0000](#) [LL01ED-ALI55R49](#) [C14707\\_IDA16-O](#) [C12231\\_LENA-FRESNEL-LENS](#)  
[LL01ED-AKY24R49](#) [LL01CR-AYG15R49](#) [LL01CR-OT32L06-M2](#) [LL01ZZ-AAA24L49](#) [LL01CR-CEN38L02](#) [LL01ZZ-AAA55L49](#)  
[LL01CR-AYG24R49](#) [LL01A00CZMB2-M2](#) [LL01ED-AKY38R49](#) [LL01CR-CNE2545L06-M2](#) [LL01ZZ-AAA38L49](#) [LL01ED-AKV36R49](#)  
[LL01ED-ALI24R49](#) [LL01CR-AYG38R49](#) [C17171\\_DAISSY-8X1-SHD-MATT](#) [F16859\\_LINDA-ZT25](#) [C17295\\_ILONA-ZOOM](#)  
[F16636\\_LINDA-W60](#) [C17362\\_DAISSY-7X1-W-D](#) [C17361\\_DAISSY-7X1-WW-D](#) [10003](#) [10003/15](#) [10048](#) [10049](#) [10108](#) [10510](#)  
[F14487\\_FLORENCE-1R-MAXI-WG](#) [12667](#) [C14165\\_STRADA-2X2-ME-WIDE2](#) [C14605\\_HB-2X2-RW](#) [C14642\\_FLORENCE-1R-UP](#)  
[CAY033](#) [CAY046/55](#) [FCX11157\\_RES-O-90](#) [OS-LRI2015X45S](#) [OSOLRA2015M](#) [PG1C-NX36](#) [PG1C-SX17](#) [PM2A-SXV1](#) [PM2B-NX55-](#)  
[AW](#) [PM6A-FN25](#) [FC2231-0000-0050-L](#) [FC2231-0000-0100-L](#) [C14116\\_STRADA-2X2-PX](#)