

DETAILS

Product Number	C14164_STRADA-2X2-ME-WIDE1
Family	Strada-Module
Type	Lens array
Color	clear
Diameter	50x50 mm
Height	8.3 mm
Style	square
Optic Material	PMMA
Holder Material	
Fastening	screw, pin, glue
Status	ready
ROHS Compliant	Yes
Date Updated	22/01/2015



OPTICAL PROPERTIES

LED	Viewing Angle	Light Beam	Efficiency	cd/lm	Connector
Oslon Square PC	Asymmetric deg	Streetligh...	84 %	0.900	: Protective Plate, Glass
XT-E	sim: Asymmetric	Streetligh...	sim: 84 %	sim: 0.000	: Protective Plate, Glass
TL1L4	Asymmetric deg	Streetligh...	83 %	0.880	: Protective Plate, Glass
LUXEON T	sim: Asym	Streetligh...	sim: 84 %	sim: 0.000	: Protective Plate, Glass
XP-G2	Asym deg	Streetligh...	83 %	0.860	: Protective Plate, Glass
LUXEON TX	Asymmetric deg	Streetligh...	84 %	0.880	: Protective Plate, Glass
XP-L	Asymmetric deg	Streetligh...	83 %	0.660	: Protective Plate, Glass

D

C

B

A

4

4

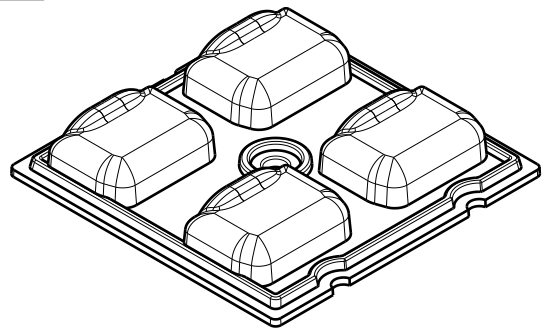
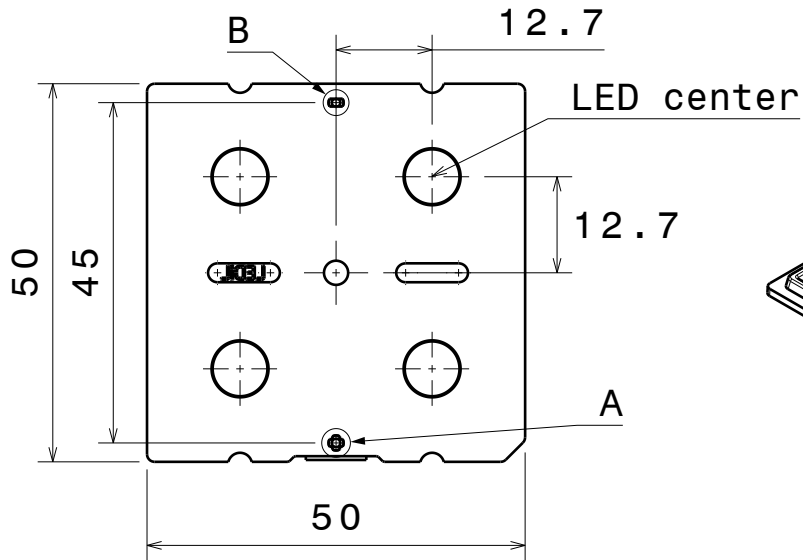

Isometric view

Bottom view

3

3

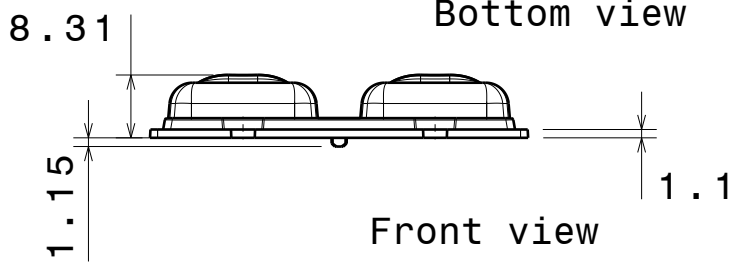

Front view

2

2

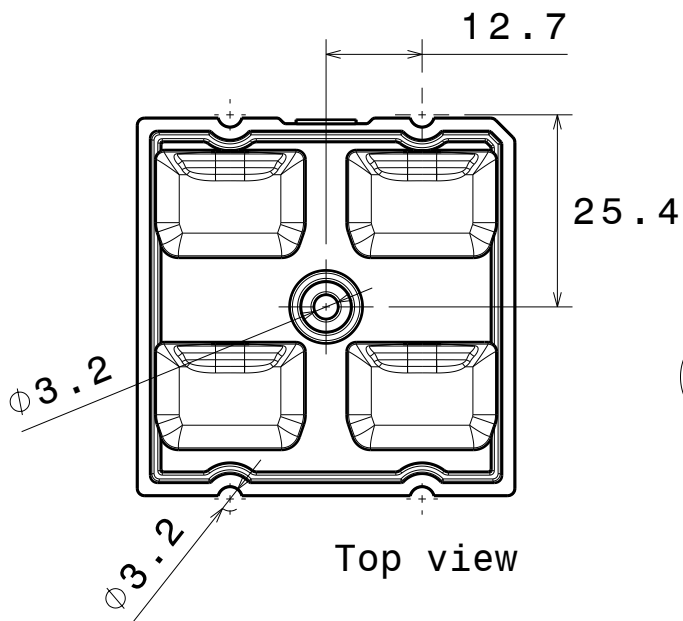

Top view

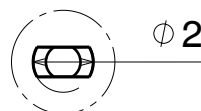

Detail B

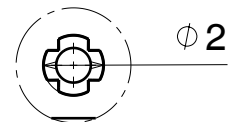

Detail A

Tolerances if not otherwise shown
 According to DIN ISO 2768-1
 Linear measures:
 Up to 30mm class M, otherwise class C.
 According to DIN ISO 2768-2
 Form and position: class L

LEDiL LediL Oy
 Salorankatu 10
 FIN 24240 SALO
 Finland

THIRD ANGLE PROJECTION:

DRAWING TITLE
STRADA-2X2-ME-WIDE1

This drawing is the property
 of LEDiL Oy. It may not be
 reproduced, copied or
 communicated without a written
 agreement with LEDiL Oy.

SIZE	PART NUMBER
A4	C14164

SCALE	1:1	WEIGHT	-	SHEET	1/1
-------	-----	--------	---	-------	-----

D

A

1

1

Luminaire: LEDiL Oy C14164_STRADA-2X2-ME-WIDE1_(SQ-PC)_glass
Lamps: 1 x OSRAM_OSLON_SQUARE_PC_2x2_(GWCSSRM1.PC)
_387.654lm@250mA_P=2.97181W_CCT=5201K_I=249.9mA

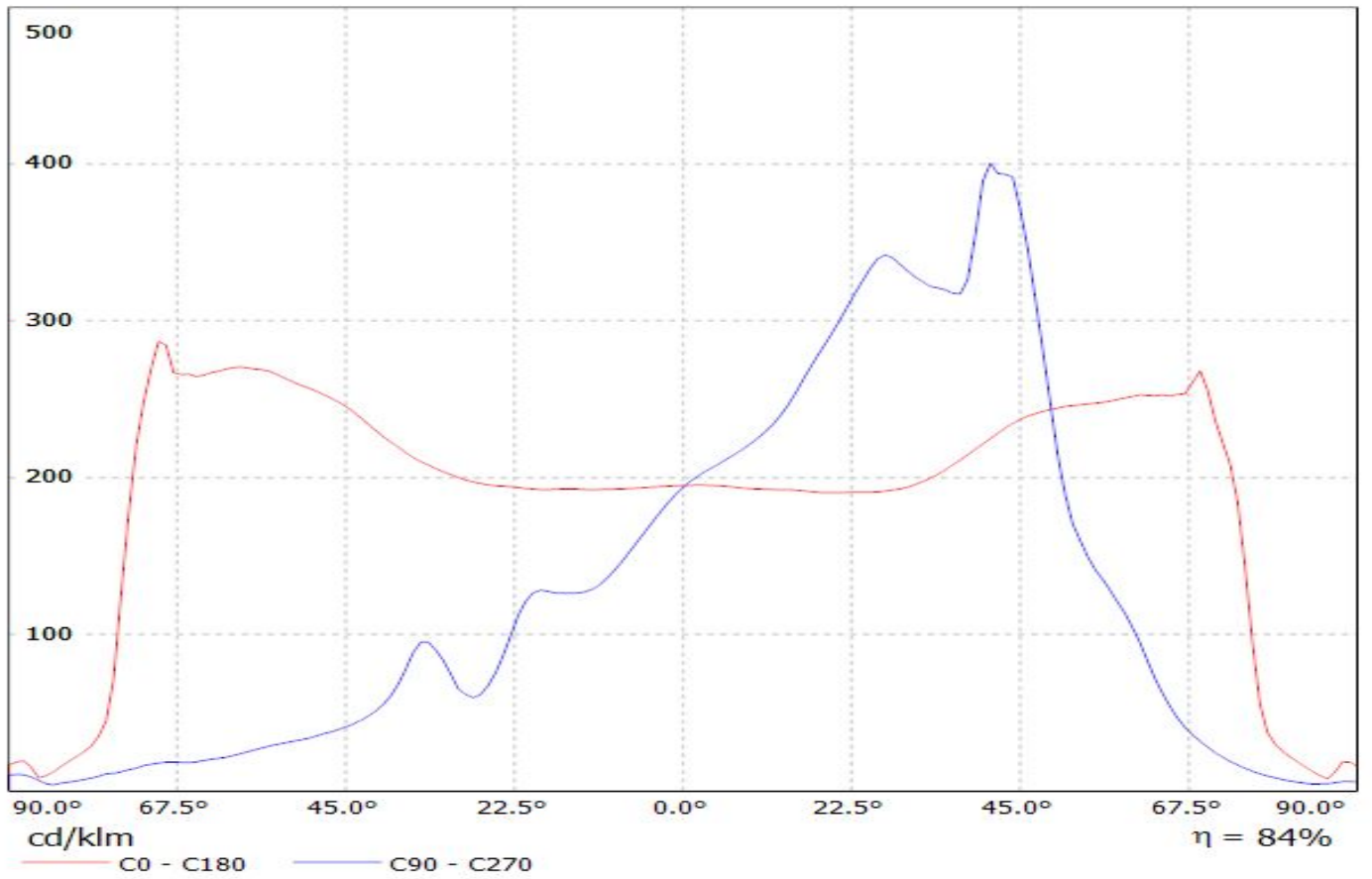

Ledil C14164_STRADA-2X2-ME-WIDE1_(TL1L4)_glass / LDC (Linear)

Luminaire: Ledil C14164_STRADA-2X2-ME-WIDE1_(TL1L4)_glass

Lamps: 1 x Toshiba_TL1L4_2x2_(TL1L4-DW0)_444.089lm@250mA_CCT=6500K_P=2.9W_I=0.25A

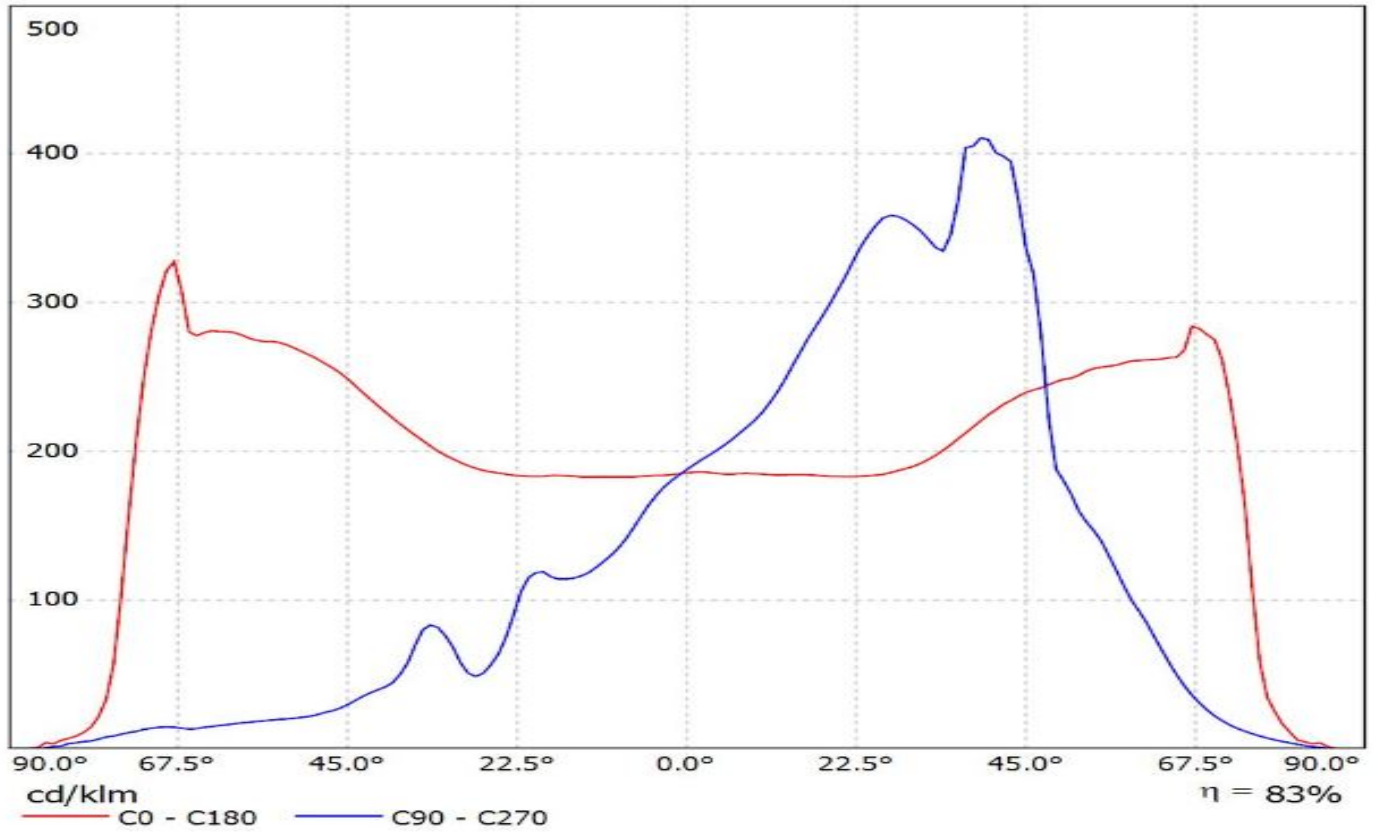

Luminaire: LEDiL Oy C14164_STRADA-2X2-ME-WIDE1_(XP-G2) with 4mm glass cover
Lamps: 1 x CREE_XP-G2_2x2_(XPGBWT-L1-000-00G51)_407.74lm@250mA_CCT=7181K_P=2.95432W_I=249.9mA

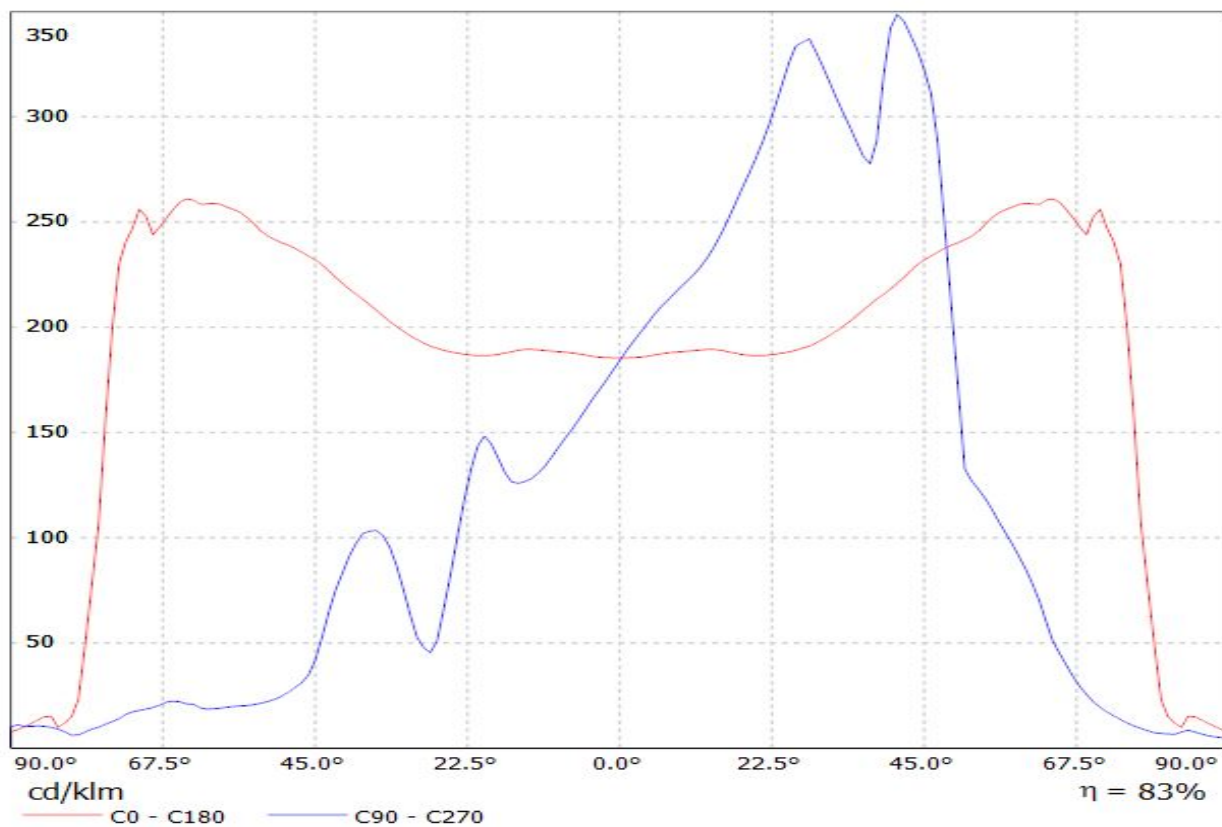

Luminaire: LEDiL Oy C14164_STRADA-2X2-ME-WIDE1 (Luxeon_TX)_glass
Lamps: 1 x Luxeon_TX_2x2_320.18lm@250mA_P=2.79576W_I=249.8mA

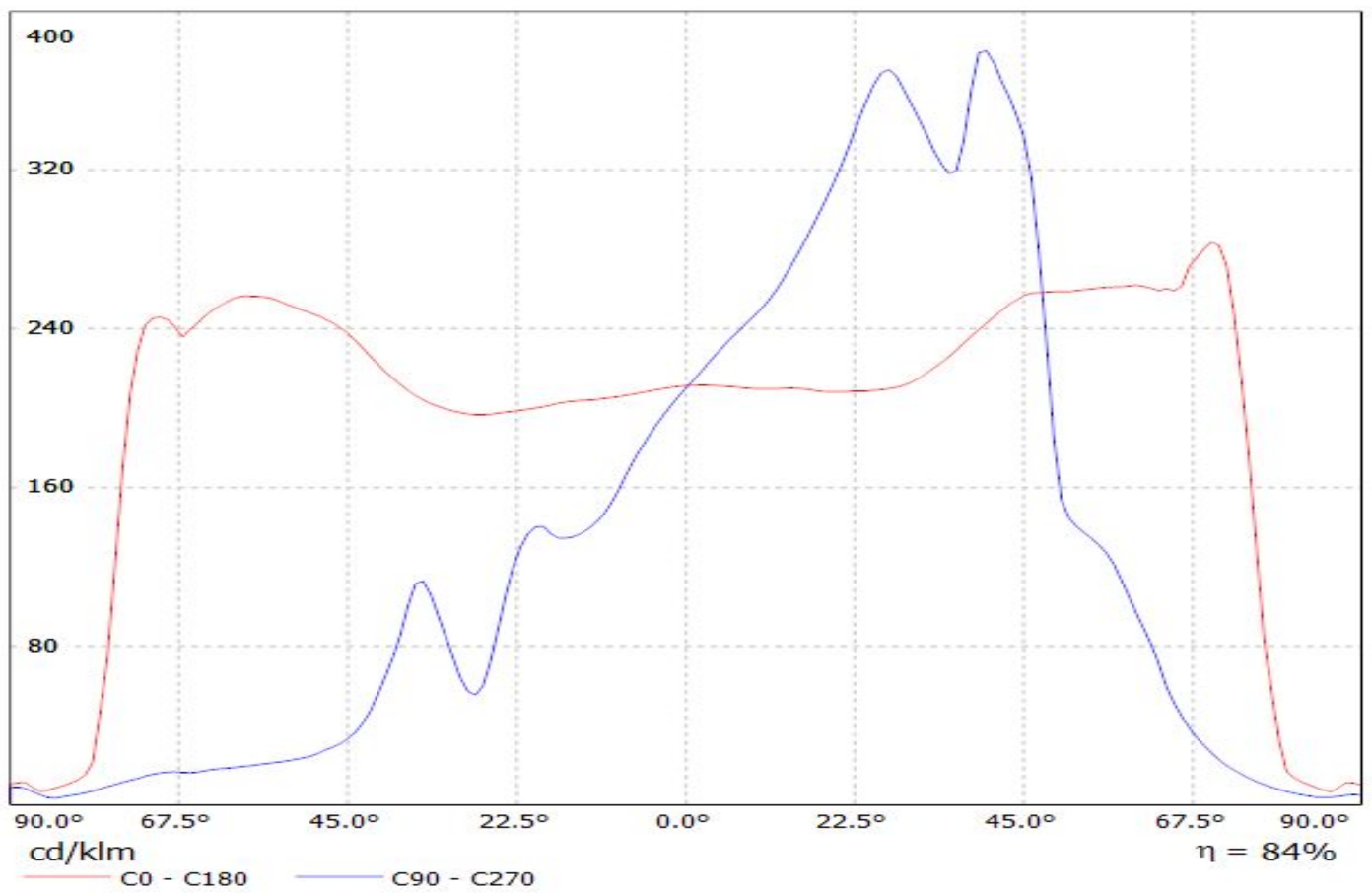

Ledil C14164_STRADA-2X2-ME-WIDE1_(XP-L)_glass / LDC (Linear)

Luminaire: Ledil C14164_STRADA-2X2-ME-WIDE1_(XP-L)_glass
Lamps: 1 x CREE_XP-L_2x2_(XPLAWT-0-1B0-V40-00-0001)
_512.395lm@250mA_CCT=7600K_P=2.8W_I=0.25A

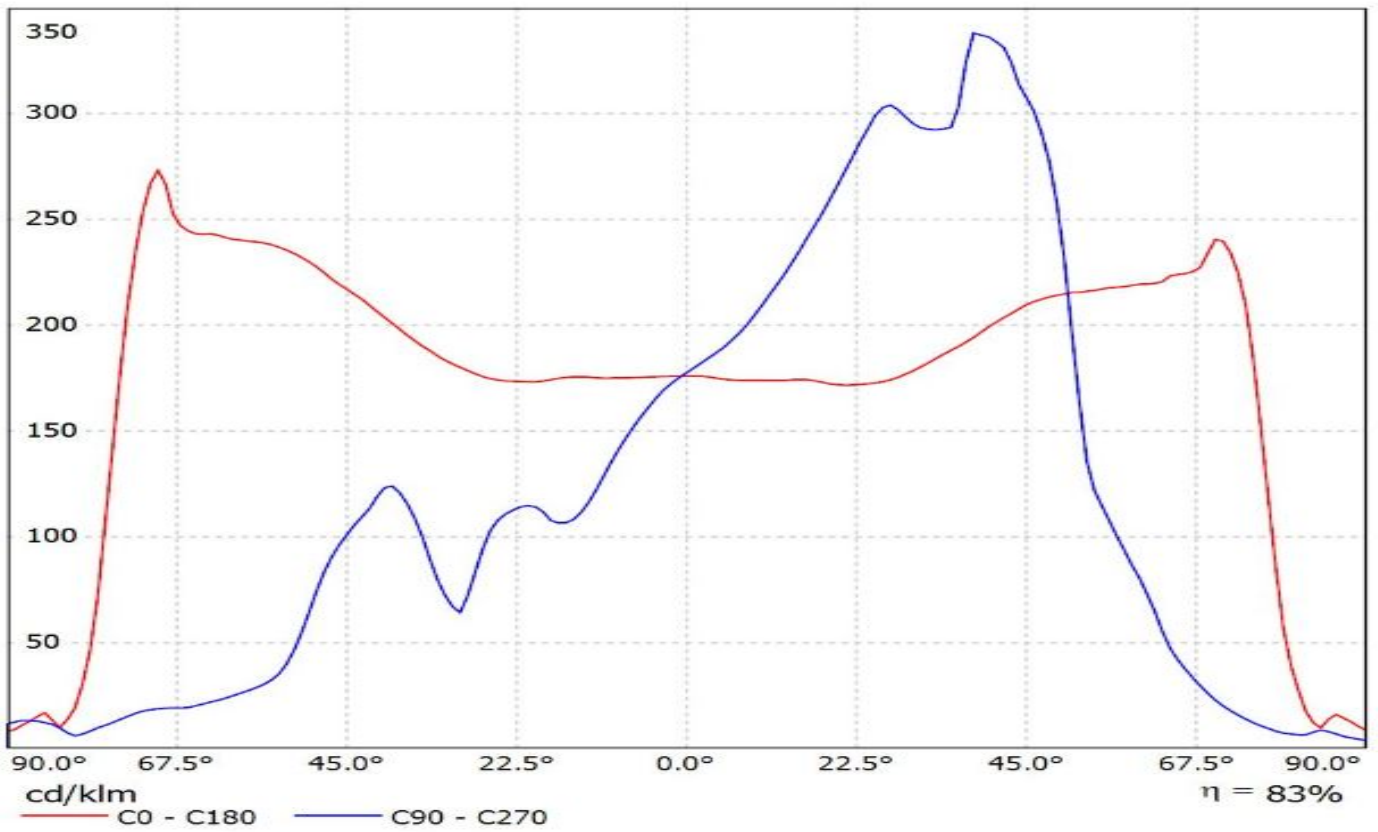

Luminaire: LEDiL Oy C14164_STRADA-2X2-ME-WIDE1_(SQ-PC)_glass
Lamps: 1 x OSRAM_OSLON_SQUARE_PC_2x2_(GWCSSRM1.PC)
_387.654lm@250mA_P=2.97181W_CCT=5201K_I=249.9mA

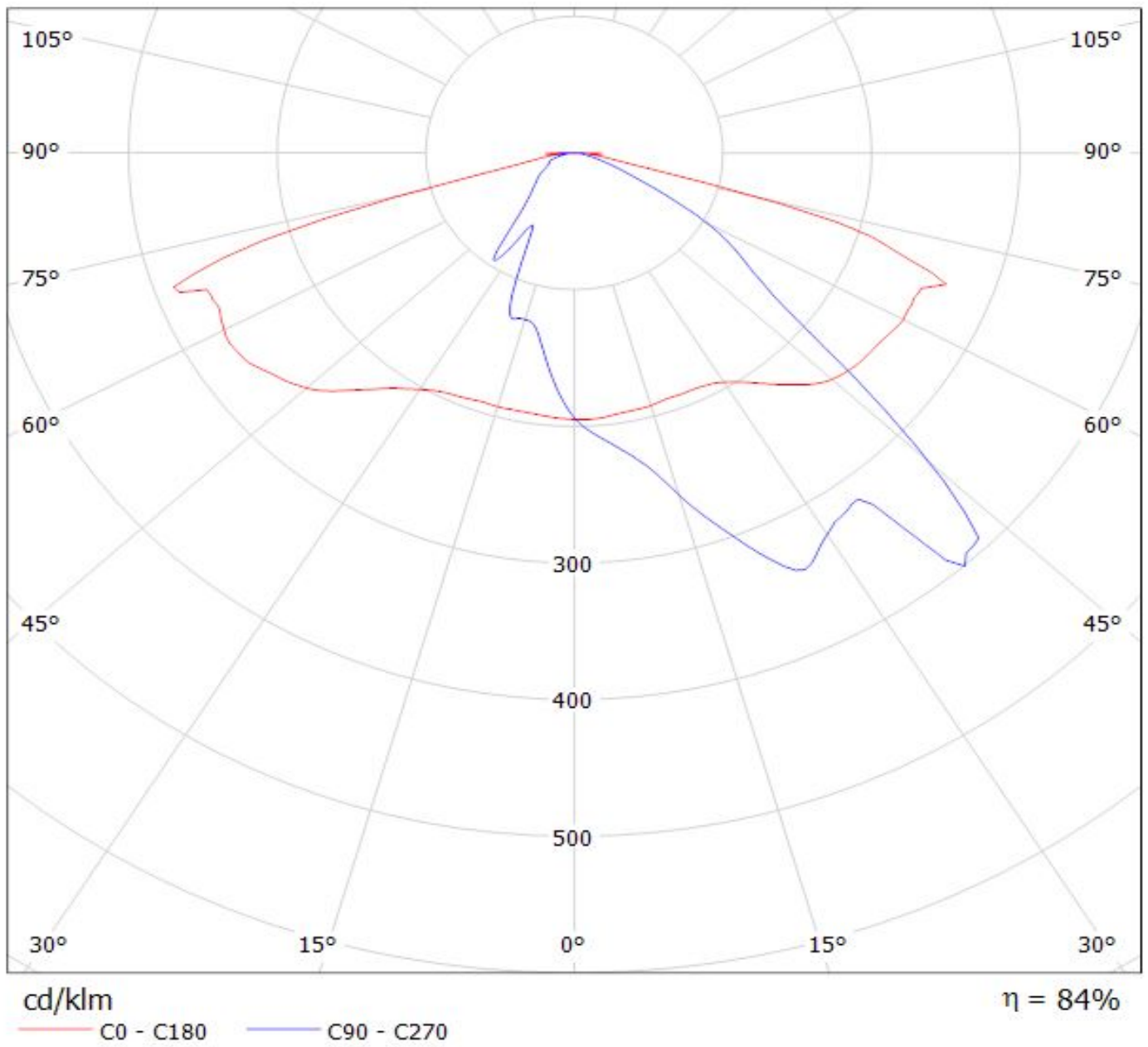

Ledil C14164_STRADA-2X2-ME-WIDE1_(TL1L4)_glass / LDC (Polar)

Luminaire: Ledil C14164_STRADA-2X2-ME-WIDE1_(TL1L4)_glass

Lamps: 1 x Toshiba_TL1L4_2x2_(TL1L4-DW0)_444.089lm@250mA_CCT=6500K_P=2.9W_I=0.25A

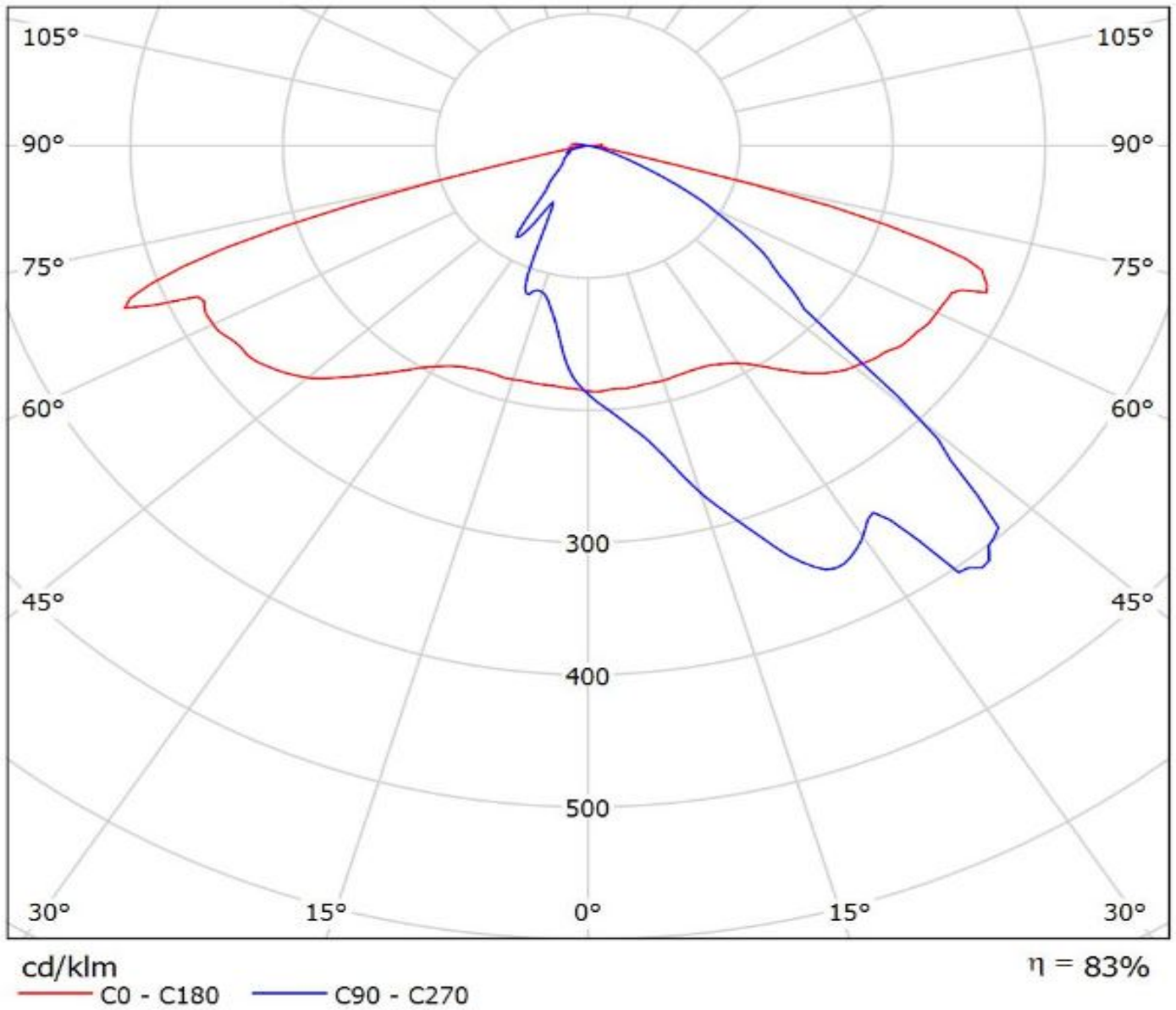

Luminaire: LEDiL Oy C14164_STRADA-2X2-ME-WIDE1_(XP-G2) with 4mm glass cover

Lamps: 1 x CREE_XP-G2_2x2_(XPGBWT-L1-000-00G51)_407.74lm@250mA_CCT=7181K_P=2.95432W_I=249.9mA

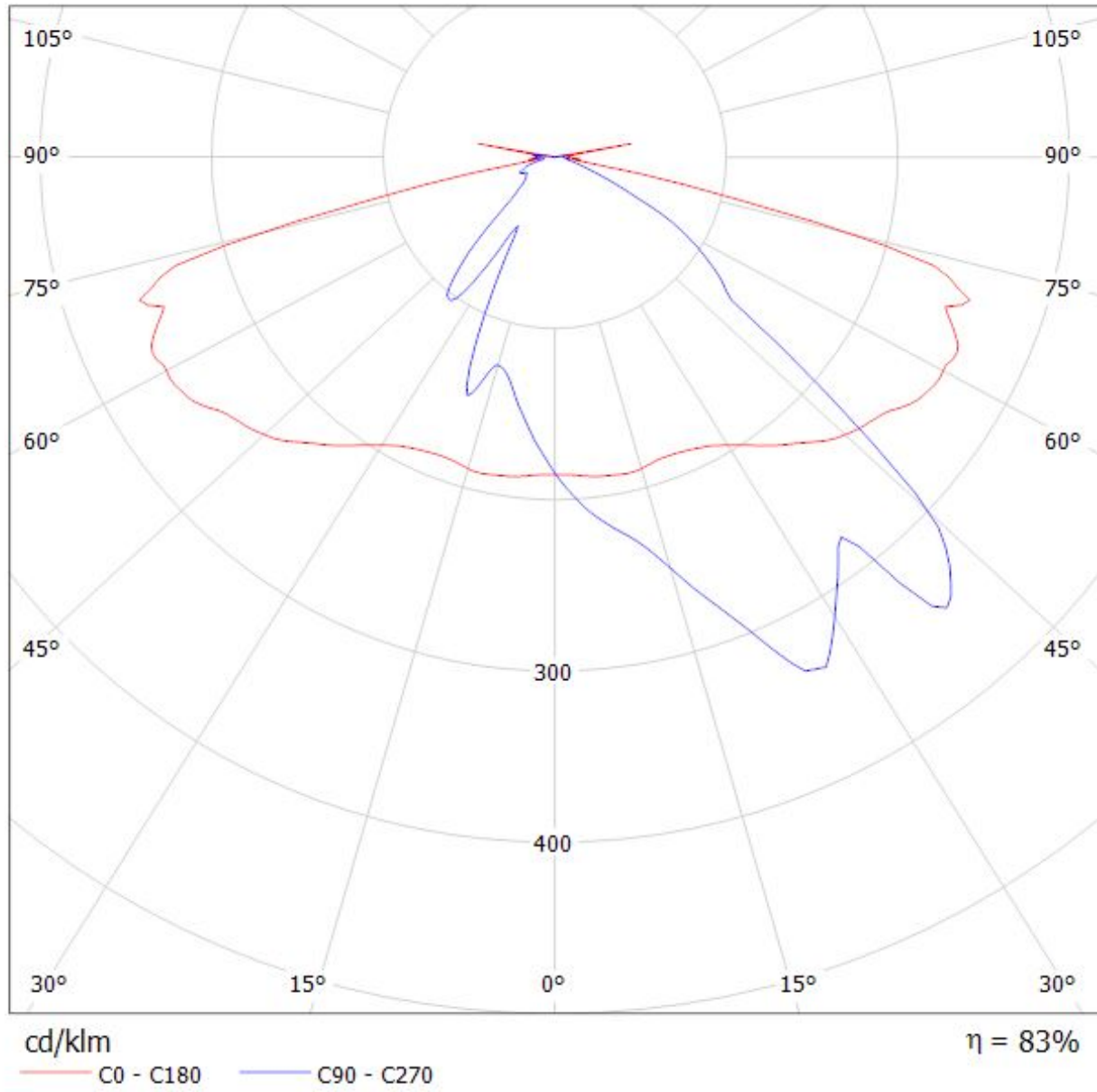

Luminaire: LEDiL Oy C14164_STRADA-2X2-ME-WIDE1_(Luxeon_TX)_glass
Lamps: 1 x Luxeon_TX_2x2_320.18lm@250mA_P=2.79576W_I=249.8mA

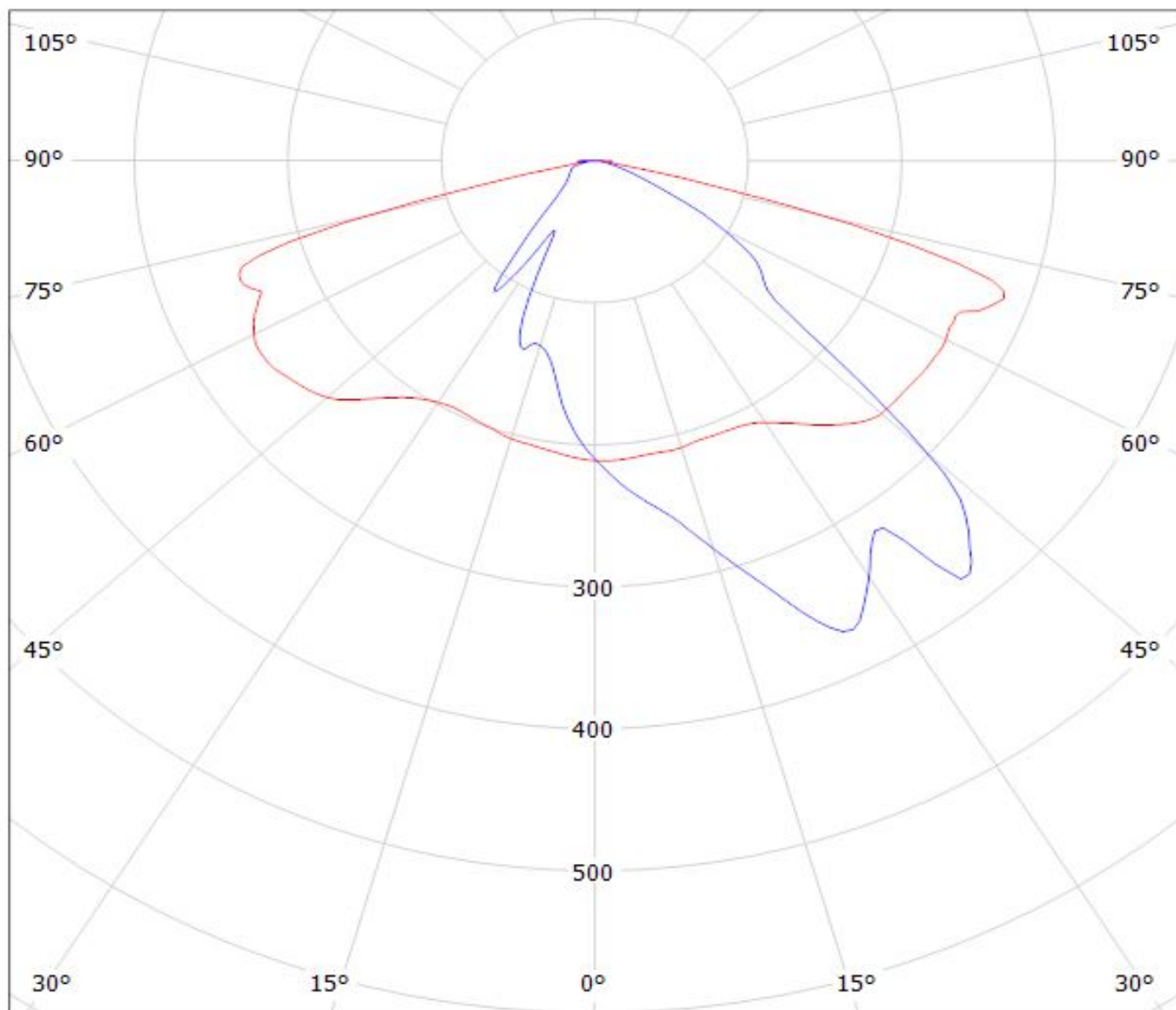

cd/klm

— C0 - C180 — C90 - C270

$\eta = 84\%$

Ledil C14164_STRADA-2X2-ME-WIDE1_(XP-L)_glass / LDC (Polar)

Luminaire: Ledil C14164_STRADA-2X2-ME-WIDE1_(XP-L)_glass

Lamps: 1 x CREE_XP-L_2x2_(XPLAWT-0-1B0-V40-00-0001)

_512.395lm@250mA_CCT=7600K_P=2.8W_I=0.25A

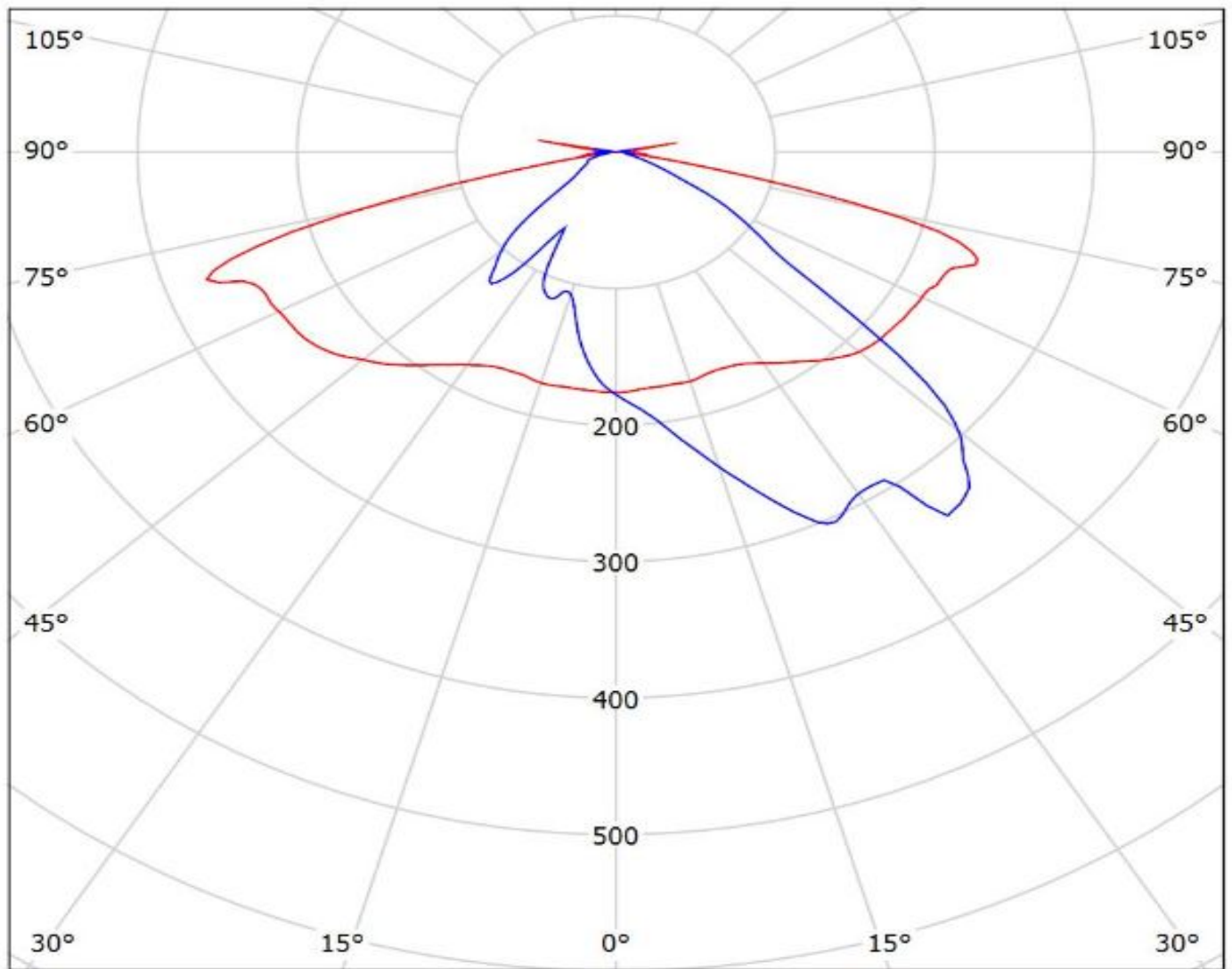

cd/klm

— C0 - C180 — C90 - C270

$\eta = 83\%$

NOTE: The typical divergence will be changed by different color, chip size and chip position tolerance. The typical total divergence is the full angle measured where the luminous intensity is half of the peak value.

X-ON Electronics

Largest Supplier of Electrical and Electronic Components

Click to view similar products for [LED Lighting Lenses](#) category:

Click to view products by [Ledil](#) manufacturer:

Other Similar products are found below :

[LL01ED-AK40L06](#) [LL01ZZ-EX25L06-M2](#) [180182-0000](#) [FNP-N2-N083-0R NRW](#) [LL01ED-ALI55R49](#) [0190535300](#) [0410111300](#)
[0510113303](#) [0530997](#) [2710121](#) [C11004_TINA2-RS](#) [C12231_LENA-FRESNEL-LENS](#) [LL01ED-AKY24R49](#) [LL01CR-AYG15R49](#)
[LL01CR-OT32L06-M2](#) [LL01ZZ-AAA24L49](#) [LL01CR-CEN38L02](#) [LL01ZZ-AAA55L49](#) [LL01CR-AYG24R49](#) [LL01A00CZMB2-M2](#)
[LL01ED-AKY38R49](#) [LL01CR-CNE2545L06-M2](#) [LL01ZZ-AAA38L49](#) [LL01ED-AKV36R49](#) [LL01ED-ALI24R49](#) [LL01CR-AYG38R49](#)
[FN15973_RONDA-REC-60-C](#) [F16859_LINDA-ZT25](#) [C14169_LENA-CLEAR-LENS](#) [C16125_OLGA-W](#) [C17410_SPORT-2X2-FT6](#)
[C17414_SPORT-2X2-S6](#) [C17409_SPORT-2X2-FT6W](#) [C17360_SPORT-2X2-FT60](#) [C17434_ILONA-WW](#) [F16636_LINDA-W60](#) [10003](#)
[10003/15](#) [10048](#) [10049](#) [10108](#) [CP10960_RGBX-SS](#) [CP12395_LXP3-W](#) [10415](#) [10510](#) [1-1000288-0](#) [F14487_FLORENCE-1R-MAXI-WG](#)
[12667](#) [C14165_STRADA-2X2-ME-WIDE2](#) [C14605_HB-2X2-RW](#)