

MOLLY-S

~25° spot beam

TECHNICAL SPECIFICATIONS:

Dimensions	Ø 69.8 mm
Height	24.8 mm
ROHS compliant	yes ⓘ

MATERIAL SPECIFICATIONS:

Component	Type	Material	Colour	Finish
MOLLY-S	Single lens	PMMA	clear	







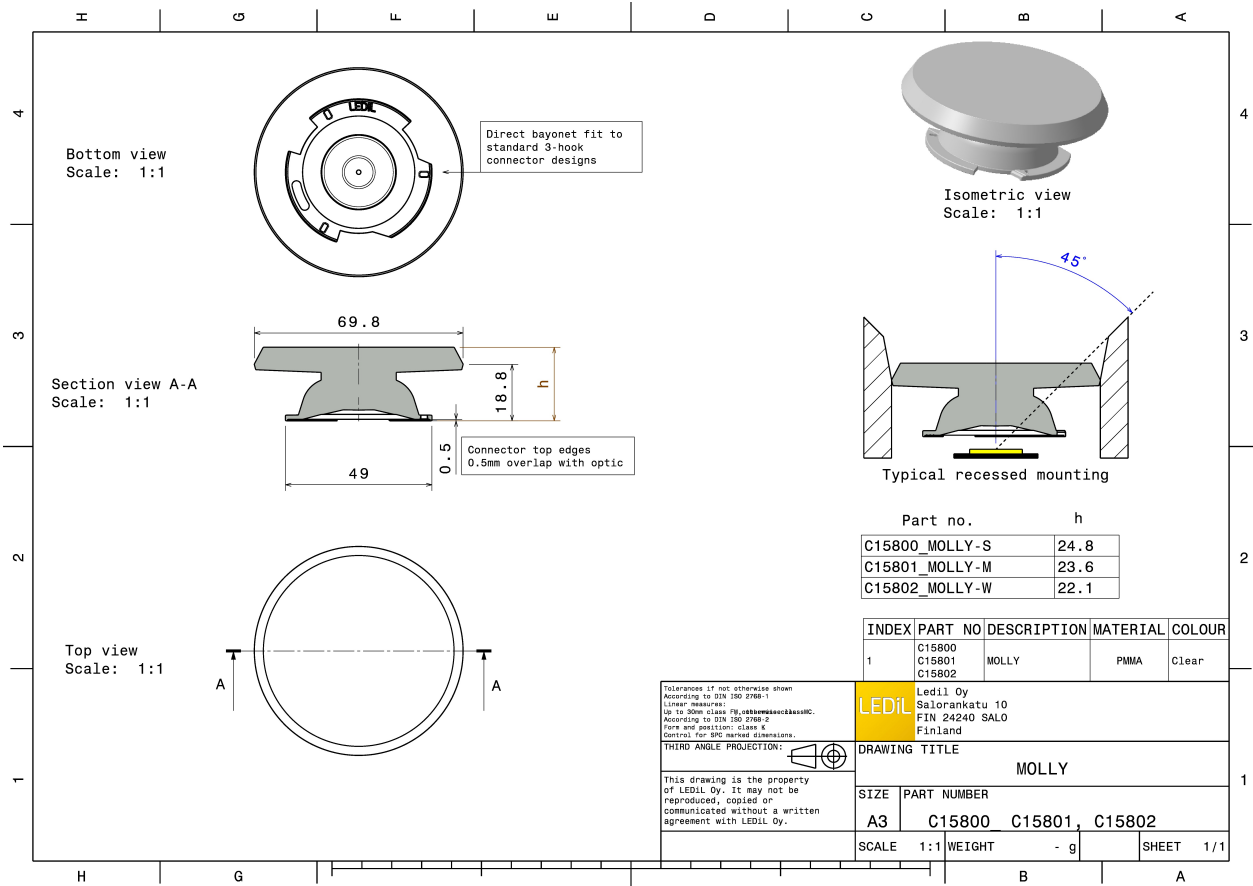



ORDERING INFORMATION:

Component	Qty in box	MOQ	MPQ	Box weight (kg)
C15800_MOLLY-S » Box size: 480 x 280 x 300 mm	198	36	18	9.7

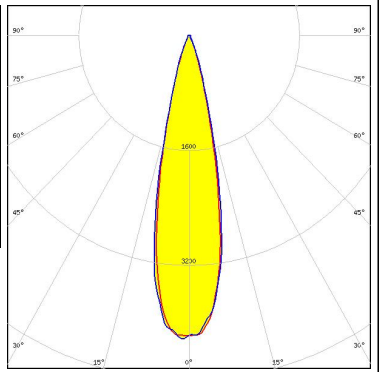

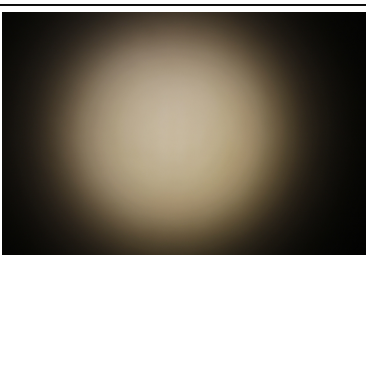
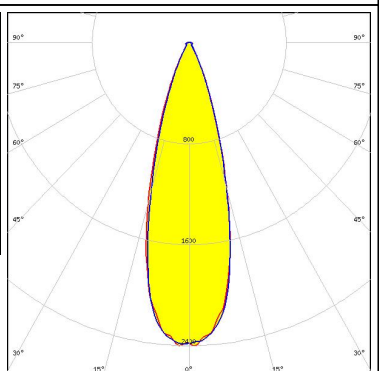
See also our general installation guide: www.ledil.com/installation_guide

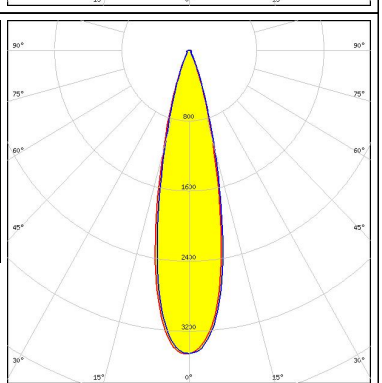
PHOTOMETRIC DATA (MEASURED):

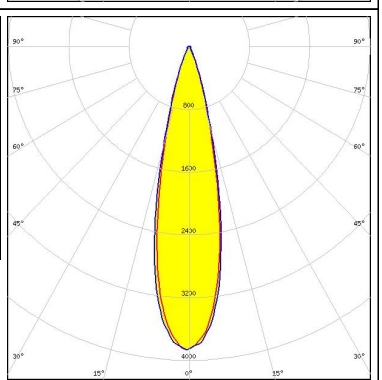
<p></p> <p>LED Vero SE 13 FWHM / FWTM 23.0° / 40.0° Efficiency 90 % Peak intensity 4.2 cd/lm LEDs/each optic 1 Light colour White Required components: C16402_CLAMP-VEROSE-13-18</p>		
<p></p> <p>LED Vero SE 18 FWHM / FWTM 31.0° / 54.0° Efficiency 88 % Peak intensity 2.4 cd/lm LEDs/each optic 1 Light colour White Required components: C16402_CLAMP-VEROSE-13-18</p>		
<p>CITIZEN</p> <p>LED CLL03x/CLU03x FWHM / FWTM 24.0° / 45.0° Efficiency 88 % Peak intensity 3.5 cd/lm LEDs/each optic 1 Light colour White Required components: C16791_CLAMP-Z45-A TE Connectivity: 2325807-3</p>		
<p>CITIZEN</p> <p>LED CLL03x/CLU03x FWHM / FWTM 23.0° / 42.0° Efficiency 87 % Peak intensity 3.9 cd/lm LEDs/each optic 1 Light colour White Required components: Bender Wirth: 433 Typ L1</p>		

PHOTOMETRIC DATA (MEASURED):

CREE LED

LED CMA1840
FWHM / FWTM 26.0° / 44.0°
Efficiency 91 %
Peak intensity 3.5 cd/lm
LEDs/each optic 1
Light colour White
Required components:
C14123_CLAMP-CXA15-18

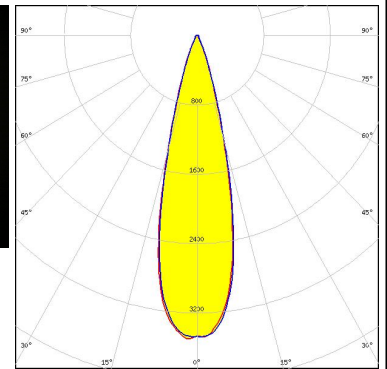
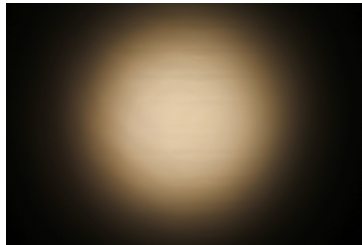

CREE LED

LED CMA2550
FWHM / FWTM 32.0° / 56.0°
Efficiency 89 %
Peak intensity 2.2 cd/lm
LEDs/each optic 1
Light colour White
Required components:
C14036_CLAMP_CXA25-30

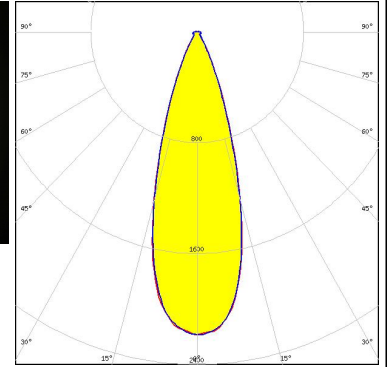

CREE LED

LED CMA3090
FWHM / FWTM 37.0° / 64.0°
Efficiency 86 %
Peak intensity 1.6 cd/lm
LEDs/each optic 1
Light colour White
Required components:
C14036_CLAMP_CXA25-30

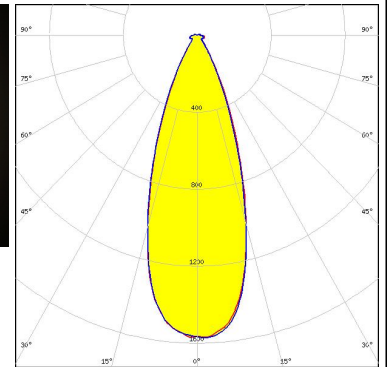
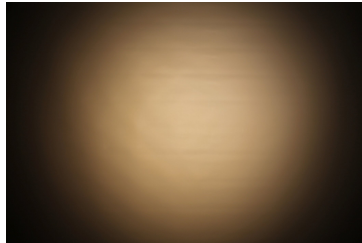



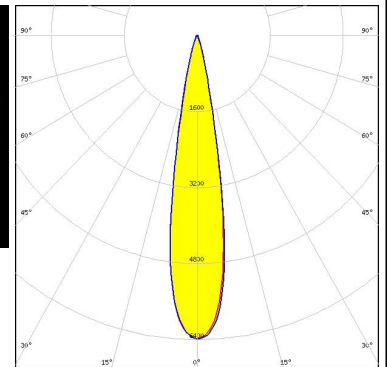

CREE LED

LED CMT14xx
FWHM / FWTM 19.0° / 32.0°
Efficiency 90 %
Peak intensity 6.4 cd/lm
LEDs/each optic 1
Light colour White
Required components:
C13658_CLAMP-VERO13-18
Bender Wirth: 434 Typ L1

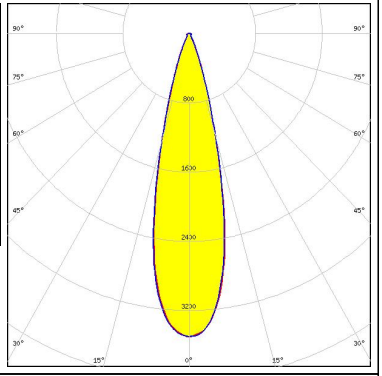

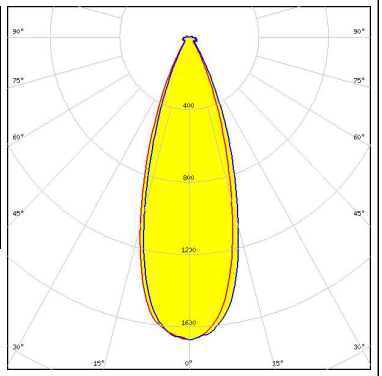
PHOTOMETRIC DATA (MEASURED):

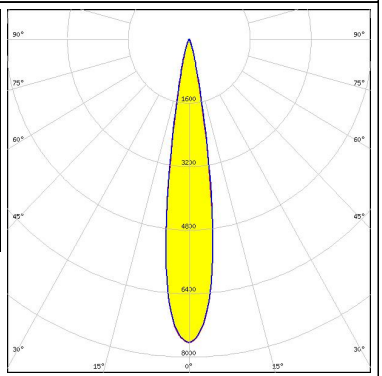
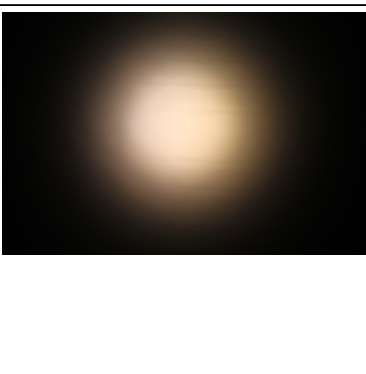
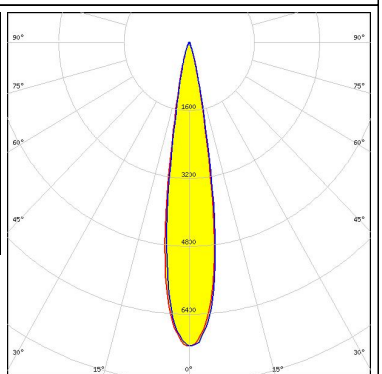
<p>CREE LED</p> <p>LED CMT19xx FWHM / FWTM 26.0° / 44.0° Efficiency 90 % Peak intensity 3.5 cd/lm LEDs/each optic 1 Light colour White</p> <p>Required components: C13658_CLAMP-VERO13-18 Bender Wirth: 477 Typ L1</p>		
<p>CREE LED</p> <p>LED CMT28xx FWHM / FWTM 35.0° / 61.0° Efficiency 85 % Peak intensity 1.7 cd/lm LEDs/each optic 1 Light colour White</p> <p>Required components: C13584_CLAMP-VERO29 Bender Wirth: 471 Typ L3</p>		
<p>CREE LED</p> <p>LED CXA/B 15xx FWHM / FWTM 17.0° / 30.0° Efficiency 91 % Peak intensity 7.6 cd/lm LEDs/each optic 1 Light colour White</p> <p>Required components: C14123_CLAMP-CXA15-18</p>		
<p>LUMILEDS</p> <p>LED LUXEON CoB 1204HD FWHM / FWTM 18.0° / 31.0° Efficiency 89 % Peak intensity 7.1 cd/lm LEDs/each optic 1 Light colour White</p> <p>Required components: TE Connectivity: 2213382-2 + OPTIC CLIP Z50 TYPE1 2213194-1</p>		

PHOTOMETRIC DATA (MEASURED):

OSRAM

LED PrevaLED Core G7 L15 H1
 FWHM / FWTM 26.0° / 48.0°
 Efficiency 89 %
 Peak intensity 3.1 cd/lm
 LEDs/each optic 1
 Light colour White
 Required components:
 C16685_CLAMP-PRV-A

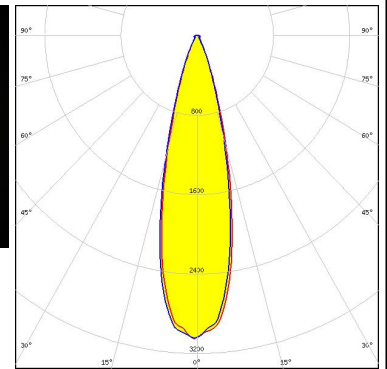
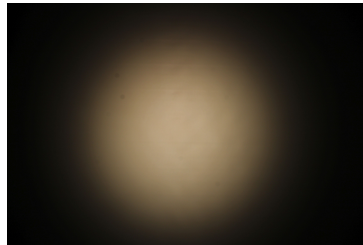

PHILIPS

LED Fortimo SLM L13 CoB
 FWHM / FWTM 24.0° / 42.0°
 Efficiency 89 %
 Peak intensity 3.9 cd/lm
 LEDs/each optic 1
 Light colour White
 Required components:
 TE Connectivity: 2213130-2 + OPTIC CLIP Z50 TYPE1 2213194-1

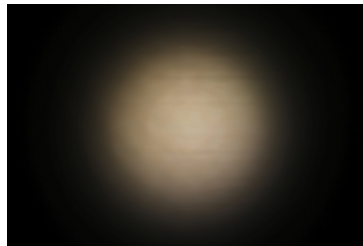

PHILIPS

LED Fortimo SLM L15 + SLM holder
 FWHM / FWTM 26.0° / 47.0°
 Efficiency 88 %
 Peak intensity 3.1 cd/lm
 LEDs/each optic 1
 Light colour White
 Required components:
 TE Connectivity: OPTIC CLIP Z50 TYPE1 2213194-1

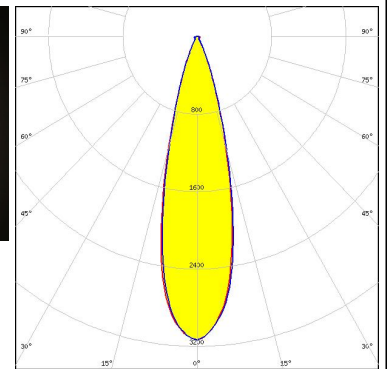
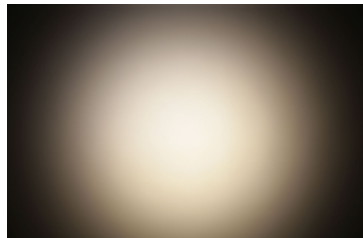

PHILIPS

LED Fortimo SLM L15 CoB
 FWHM / FWTM 27.0° / 47.0°
 Efficiency 88 %
 Peak intensity 3.1 cd/lm
 LEDs/each optic 1
 Light colour White
 Required components:
 TE Connectivity: 2213130-2 + OPTIC CLIP Z50 TYPE1 2213194-1

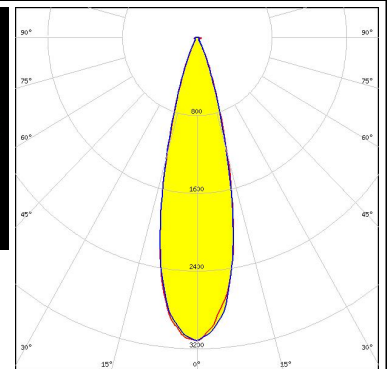
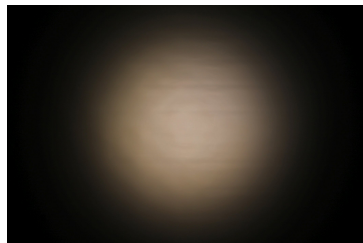

PHOTOMETRIC DATA (MEASURED):

XICATO

LED XTM - 19mm LES
FWHM / FWTM 28.0° / 52.0°
Efficiency 89 %
Peak intensity 2.6 cd/lm
LEDs/each optic 1
Light colour White
Required components:
C16491_XTM-ADAPTER-50-A

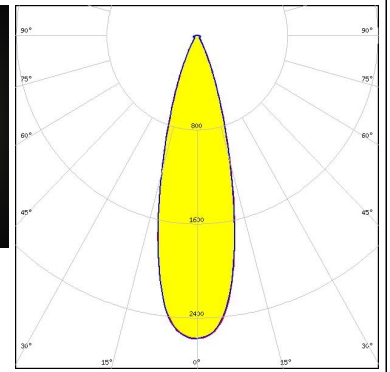
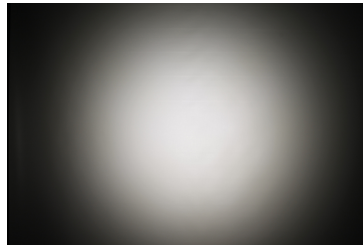

PHOTOMETRIC DATA (SIMULATED):



LED V9 HD
FWHM / FWTM 16.0° / 26.0°
Efficiency 91 %
Peak intensity 10.8 cd/lm
LEDs/each optic 1
Light colour White
Required components:
 C13658_CLAMP-VERO13-18
 Bender Wirth: 496 Typ L1



LED VERO13
FWHM / FWTM 21.0° / 39.0°
Efficiency 90 %
Peak intensity 5.2 cd/lm
LEDs/each optic 1
Light colour White
Required components:
 C13658_CLAMP-VERO13-18

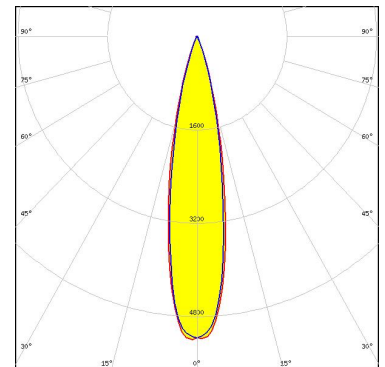

CITIZEN

LED CLL02x/CLU02x (LES10)
FWHM / FWTM 16.0° / 30.0°
Efficiency 87 %
Peak intensity 8.8 cd/lm
LEDs/each optic 1
Light colour White
Required components:
 Bender Wirth: 434 Typ L1

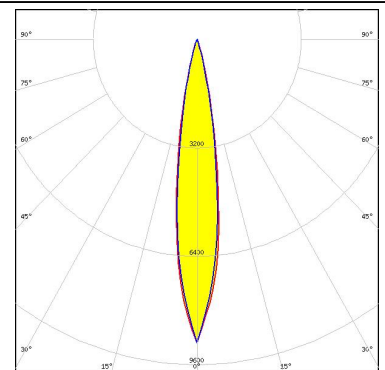

LED CXA/B 1816 & CXA/B 1820 & CXA 1850
FWHM / FWTM 19.0° / 34.0°
Efficiency 89 %
Peak intensity 6.5 cd/lm
LEDs/each optic 1
Light colour White
Required components:
 C14123_CLAMP-CXA15-18

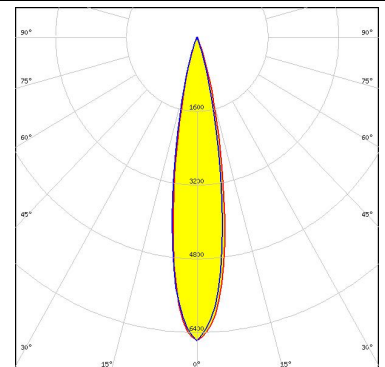

PHOTOMETRIC DATA (SIMULATED):



LED CXA/B 25xx
FWHM / FWTM 25.0° / 47.0°
Efficiency 85 %
Peak intensity 3.5 cd/lm
LEDs/each optic 1
Light colour White
Required components:
C14036_CLAMP_CXA25-30

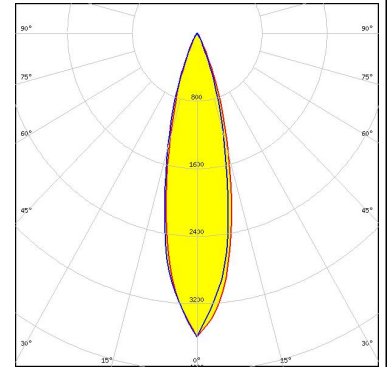

LED LUXEON CoB 1205HD
FWHM / FWTM 19.0° / 33.0°
Efficiency 86 %
Peak intensity 6.8 cd/lm
LEDs/each optic 1
Light colour White
Required components:
C13658_CLAMP-VERO13-18
Bender Wirth: 480 Typ L1



LED CTM-18 (Tunable White)
FWHM / FWTM 23.0° / 47.0°
Efficiency 78 %
Peak intensity 3.1 cd/lm
LEDs/each optic 1
Light colour White
Required components:
C13658_CLAMP-VERO13-18

GENERAL INFORMATION:

NOTE: The typical beam angle will be changed by different color, chip size and chip position tolerance. The typical total beam angle is the full angle measured where the luminous intensity is half of the peak value.

Due to use of high power COB's with this product, special attention to proper thermal design is highly recommended. LEDiL has no liability for direct, indirect or consecutive damages arising from the LEDiL products being used outside of the recommended temperature range.

MATERIALS:

As part of our continuous research and improvement processes, and to ensure the best possible quality and availability of our products, LEDiL reserves the right to change material grades without notice.

PRODUCT DATA USER AGREEMENT AND DISCLAIMER:

The measured data in the provided downloadable LEDiL Product Datasheets and Mechanical 2D-Drawings is rounded and provided as reference for planning. LEDiL Oy's optical specifications have been verified by conducting performance testing of the products in accordance with the company's quality system. The reported data are averaged results of multiple measurements with typical variation. LEDiL Oy reserves the right to without prior notification make changes and improvements to its products.

LEDiL Oy assumes neither warranty, nor guarantee nor any other liability of any kind for the contents and correctness of the provided data. The provided data has been generated with highest diligence but the provided data may in reality not represent the complete possible variation range of all intrinsic parameters. Therefore, in certain cases a deviation from the provided data could occur.

LEDiL Oy reserves the right to undertake technical changes of its products without further notification which could lead to changes in the provided data. LEDiL Oy assumes no liability of any kind for the possible deviation from any provided data or any other damage resulting from the usage of the provided data.

The user agrees to this disclaimer and user agreement with the download or usage of the provided files.

LEDiL Oy

Joensuunkatu 13
FI-24240 SALO
Finland

LEDiL Inc.

228 West Page Street
Suite D
Sycamore IL 60178
USA

Ledil Optics Technology (Shenzhen) Co., Ltd.

405 , Block B
Casic Motor Building
Shenzhen 518057
P.R.CHINA

Local sales and technical support

[www.ledil.com/
where_to_buy](http://www.ledil.com/where_to_buy)

Shipping locations

Salo, Finland
Hong Kong, China

Distribution Partners

[www.ledil.com/
where_to_buy](http://www.ledil.com/where_to_buy)

X-ON Electronics

Largest Supplier of Electrical and Electronic Components

Click to view similar products for [LED Lighting Lenses](#) category:

Click to view products by [Ledil](#) manufacturer:

Other Similar products are found below :

[LL01ED-AK40L06](#) [LL01ZZ-EX25L06-M2](#) [180182-0000](#) [LL01ED-ALI55R49](#) [C14707_IDA16-O](#) [C12231_LENA-FRESNEL-LENS](#)
[LL01ED-AKY24R49](#) [LL01CR-AYG15R49](#) [LL01CR-OT32L06-M2](#) [LL01ZZ-AAA24L49](#) [LL01CR-CEN38L02](#) [LL01ZZ-AAA55L49](#)
[LL01CR-AYG24R49](#) [LL01A00CZMB2-M2](#) [LL01ED-AKY38R49](#) [LL01CR-CNE2545L06-M2](#) [LL01ZZ-AAA38L49](#) [LL01ED-AKV36R49](#)
[LL01ED-ALI24R49](#) [LL01CR-AYG38R49](#) [C17171_DAISSY-8X1-SHD-MATT](#) [F16859_LINDA-ZT25](#) [C17295_ILONA-ZOOM](#)
[F16636_LINDA-W60](#) [C17362_DAISSY-7X1-W-D](#) [C17361_DAISSY-7X1-WW-D](#) [10003](#) [10003/15](#) [10048](#) [10049](#) [10108](#) [10510](#)
[F14487_FLORENCE-1R-MAXI-WG](#) [12667](#) [C14165_STRADA-2X2-ME-WIDE2](#) [C14605_HB-2X2-RW](#) [C14642_FLORENCE-1R-UP](#)
[CAY033](#) [CAY046/55](#) [FCX11157_RES-O-90](#) [OS-LRI2015X45S](#) [OSOLRA2015M](#) [PG1C-NX36](#) [PG1C-SX17](#) [PM2A-SXV1](#) [PM2B-NX55-](#)
[AW](#) [PM6A-FN25](#) [FC2231-0000-0050-L](#) [FC2231-0000-0100-L](#) [C14116_STRADA-2X2-PX](#)