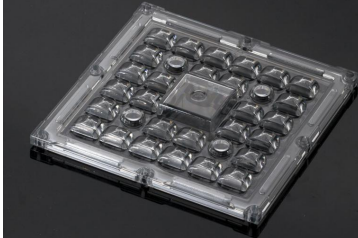
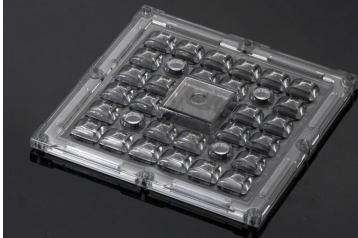

**Product number CS15911_STRADELLA-IP-28-T2-PC**

Family	Stradella	FWHM	(simulated) Asymmetric
Type	Lens	Efficiency	-
LED	XT-E	cd/lm	(simulated) 0.000
Color	Clear	Gerber File	Available
Diameter	100*100 mm		
Height	9.2 mm		
Style	Square		
Optic Material	PC		
Holder Material	-		
Fastening	["screw"]		
Status	Production ready		

**Product number CS16102_STRADELLA-IP-28-T3**

Family	Stradella	FWHM	Asymmetric degrees
Type	Lens	Efficiency	94 %
LED	XT-E	cd/lm	0.600
Color	Clear	Gerber File	Available
Diameter	100 x 100 mm		
Height	-		
Style	Square		
Optic Material	PMMA		
Holder Material	-		
Fastening	["pin", "screw"]		
Status	Production ready		

**Product number CS16104_STRADELLA-IP-28-T3-PC**

Family	Stradella	FWHM	Asymmetric degrees
Type	Lens	Efficiency	90 %
LED	XT-E	cd/lm	0.660
Color	Clear	Gerber File	Available
Diameter	100 x 100 mm		
Height	-		
Style	Square		
Optic Material	PC		
Holder Material	-		
Fastening	["pin", "screw"]		
Status	Production ready		

**Product number CS16322_STRADELLA-IP-28-HB-S**

Family	Stradella	FWHM	(simulated) 29
Type	Assembly	Efficiency	(simulated) 92 %
LED	XT-E	cd/lm	(simulated) 1.659
Color	Clear	Gerber File	Available
Diameter	100 x 100 mm		
Height	9.5 mm		
Style	Square		
Optic Material	-		
Holder Material	-		
Fastening	["pin", "screw"]		
Status	Sample approved		

Product number CS16323_STRADELLA-IP-28-HB-M

Family	Stradella	FWHM	(simulated) 57
Type	Assembly	Efficiency	(simulated) 92 %
LED	XT-E	cd/lm	(simulated) 0.698
Color	Clear	Gerber File	Available
Diameter	100 x 100 mm		
Height	9.5 mm		
Style	Square		
Optic Material	-		
Holder Material	-		
Fastening	["pin", "screw"]		
Status	Sample approved		

Product number CS16324_STRADELLA-IP-28-HB-W

Family	Stradella	FWHM	(simulated) 82
Type	Assembly	Efficiency	(simulated) 92 %
LED	XT-E	cd/lm	(simulated) 0.496
Color	Clear	Gerber File	Available
Diameter	100 x 100 mm		
Height	9.5 mm		
Style	Square		
Optic Material	-		
Holder Material	-		
Fastening	["pin", "screw"]		
Status	Sample approved		

Product number CS16328_STRADELLA-IP-28-HB-S-PC

Family	Stradella	FWHM	(simulated) 27
Type	Assembly	Efficiency	(simulated) 89 %
LED	XT-E	cd/lm	(simulated) 1.902
Color	Clear	Gerber File	Available
Diameter	100 x 100 mm		
Height	9.5 mm		
Style	Square		
Optic Material	-		
Holder Material	-		
Fastening	["pin", "screw"]		
Status	Sample approved		

Product number CS16329_STRADELLA-IP-28-HB-M-PC

Family	Stradella	FWHM	(simulated) 53
Type	Assembly	Efficiency	(simulated) 89 %
LED	XT-E	cd/lm	(simulated) 0.760
Color	Clear	Gerber File	Available
Diameter	100 x 100 mm		
Height	9.5 mm		
Style	Square		
Optic Material	-		
Holder Material	-		
Fastening	["pin", "screw"]		
Status	Sample approved		

PRODUCT DATASHEET
Stradella series

last update 15/12/2017

**Product number** CS16330_STRADELLA-IP-28-HB-W-PC

Family	Stradella	FWHM	(simulated) 78
Type	Assembly	Efficiency	(simulated) 89 %
LED	XT-E	cd/lm	(simulated) 0.531
Color	Clear	Gerber File	Available
Diameter	100 x 100 mm		
Height	9.5 mm		
Style	Square		
Optic Material	-		
Holder Material	-		
Fastening	["pin", "screw"]		
Status	Sample approved		

NOTE: The typical divergence will be changed by different color, chip size and chip position tolerance. The typical total divergence is the full angle measured where the luminous intensity is half of the peak value.



PRODUCT DATASHEET

Stradella series

last update 15/12/2017

GENERAL INFORMATION

- Product series especially designed & optimized for XT-E series of LEDs.
- Special care taken to make light distribution as uniform as possible.
- Lens material optical grade PMMA with high UV and temperature resistance. Allows use of high current and temperature conditions.

Please find more information about used material from below:

http://ledil.fi/sites/default/files/Documents/Technical/Material/PMMA%20N%20UL94_Yellow%20Card.pdf

<http://ledil.fi/sites/default/files/Documents/Technical/Material/PMMA%20N%20PLEXIGLAS-Datasheet.pdf>

- Lens material optical grade PC with high UV and temperature resistance (100 degrees of Celcius / 212 degrees of Fahrenheit). Allows use of high current and temperature conditions.

Please find more information about used materials from below:

http://ledil.fi/sites/default/files/Documents/Technical/Material/PC%20Makrolon%202400_2407_2456_2458-UL.pdf

H

G

F

E

4

3

2

1

100

A

46.7

46.7

4.9

100
46.7
46.7

∅ 3.54

9.2

Typical space for component

5.8

A

Detail D
Scale: 2:1

Beam direc

PCB space inside
seal 81x 81mm

D

B

2

Section view A-A
Scale: 1:1

Detail B
Scale: 2:1

H

G

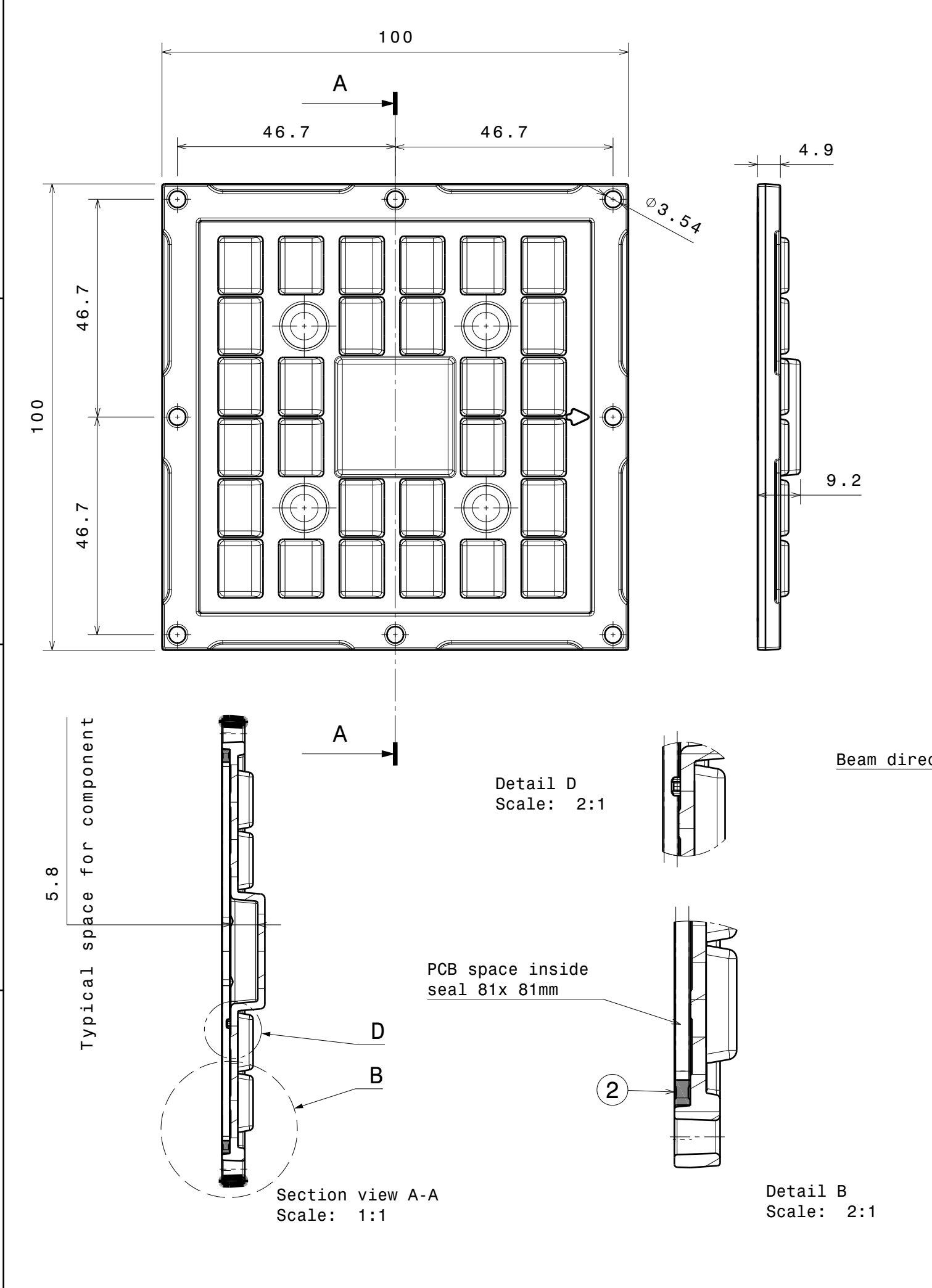

Luminaire: Ledil CS16102_STRADELLA-IP-28-T3_(XT-E)

Lamps: 1 x Cree_XT-E_Stradella-28_1805.68lm@250mA_P=9.51344W_U=38.069V

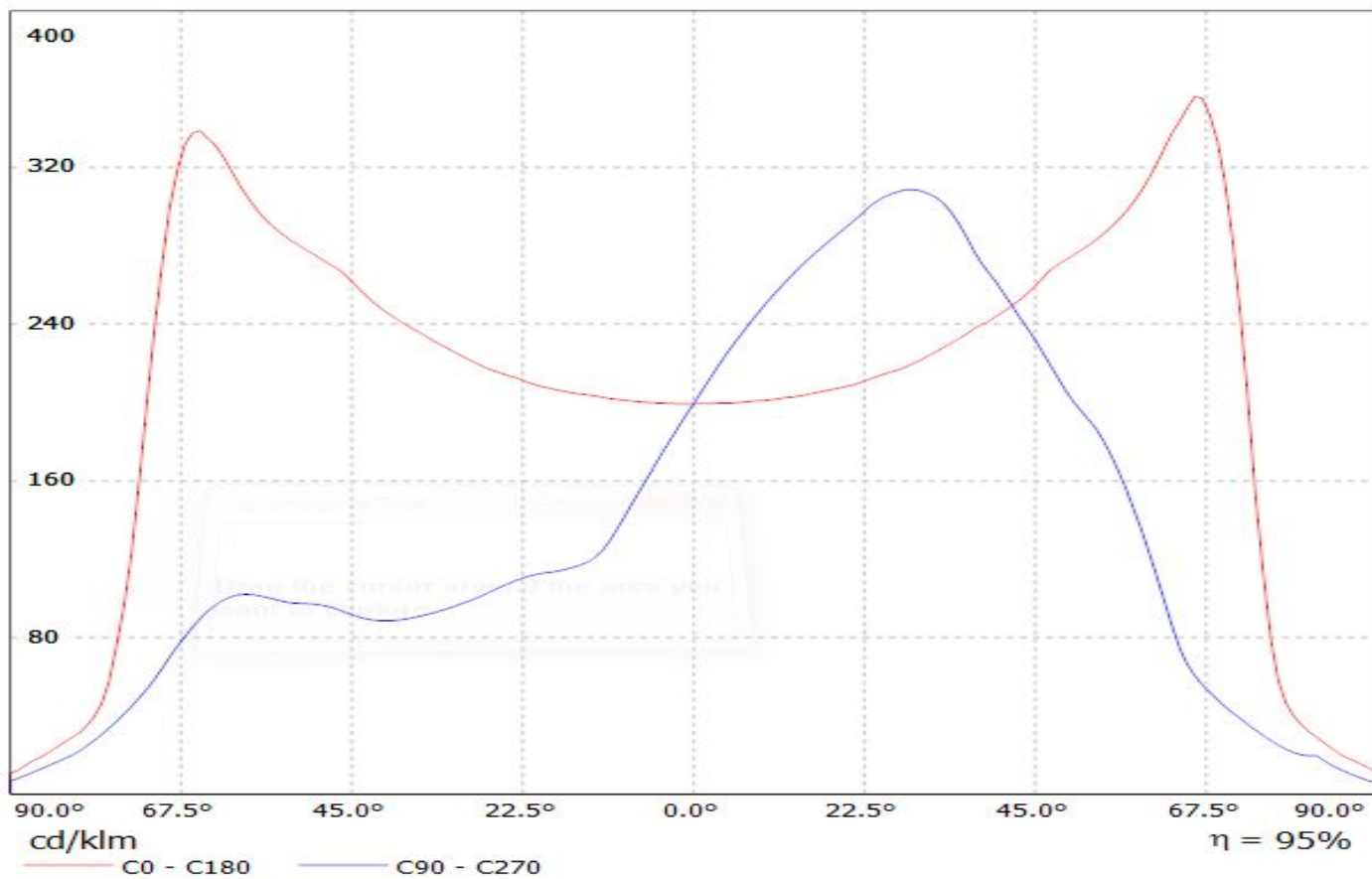

Luminaire: Ledil CS16104_STRADELLA-IP-28-T3-PC_(XT-E)

Lamps: 1 x Cree_XT-E_Stradella-28_1802.62lm@250mA_CCT=5700K_P=9.5072W_U=38.110V

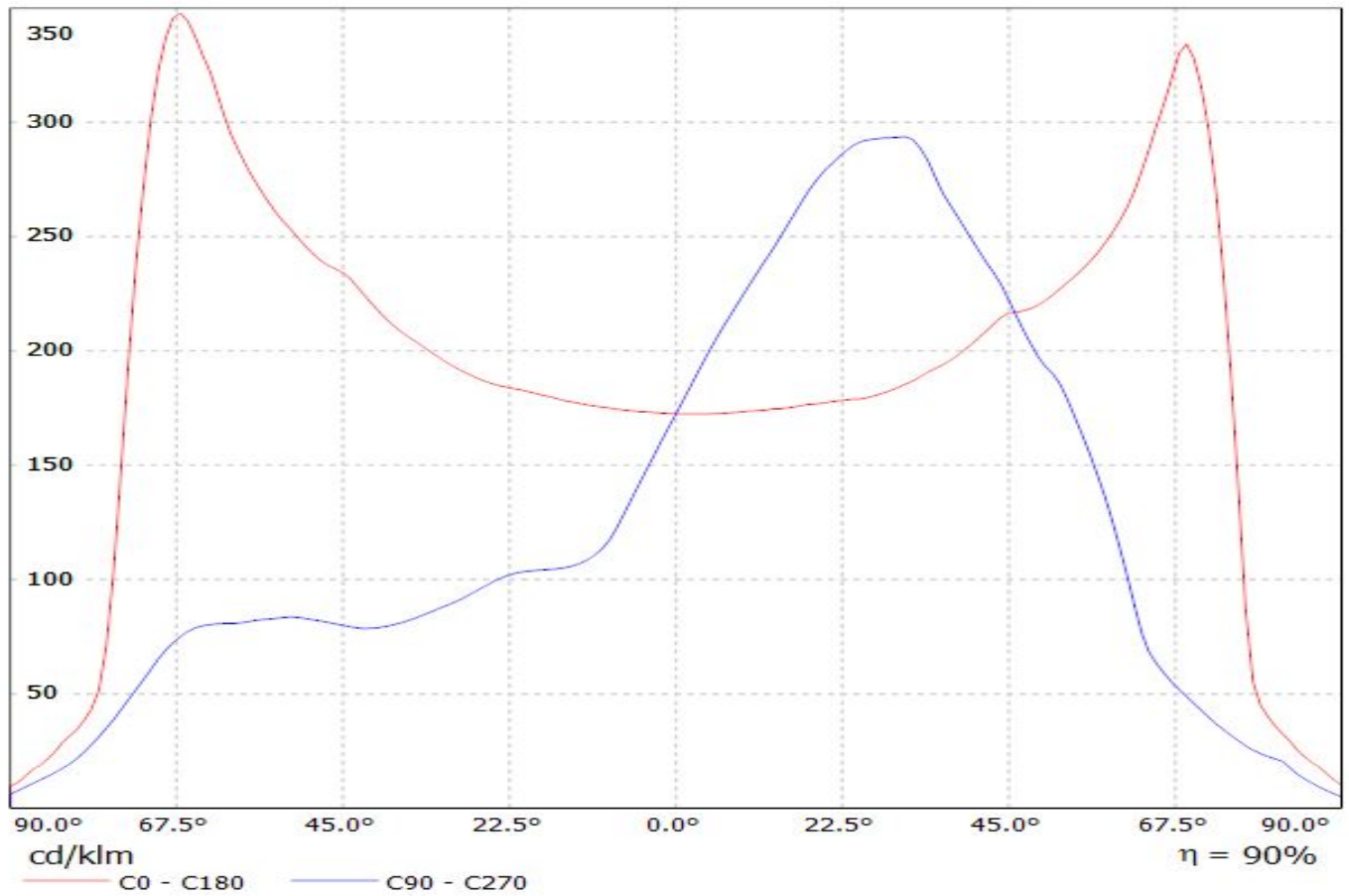

Valaisin: Ledil Oy CS16322_STRADELLA-IP-28-HB-S_(Cree XT-E)_SIMULATED
Lamput: 1 x Cree XT-E (100lm)

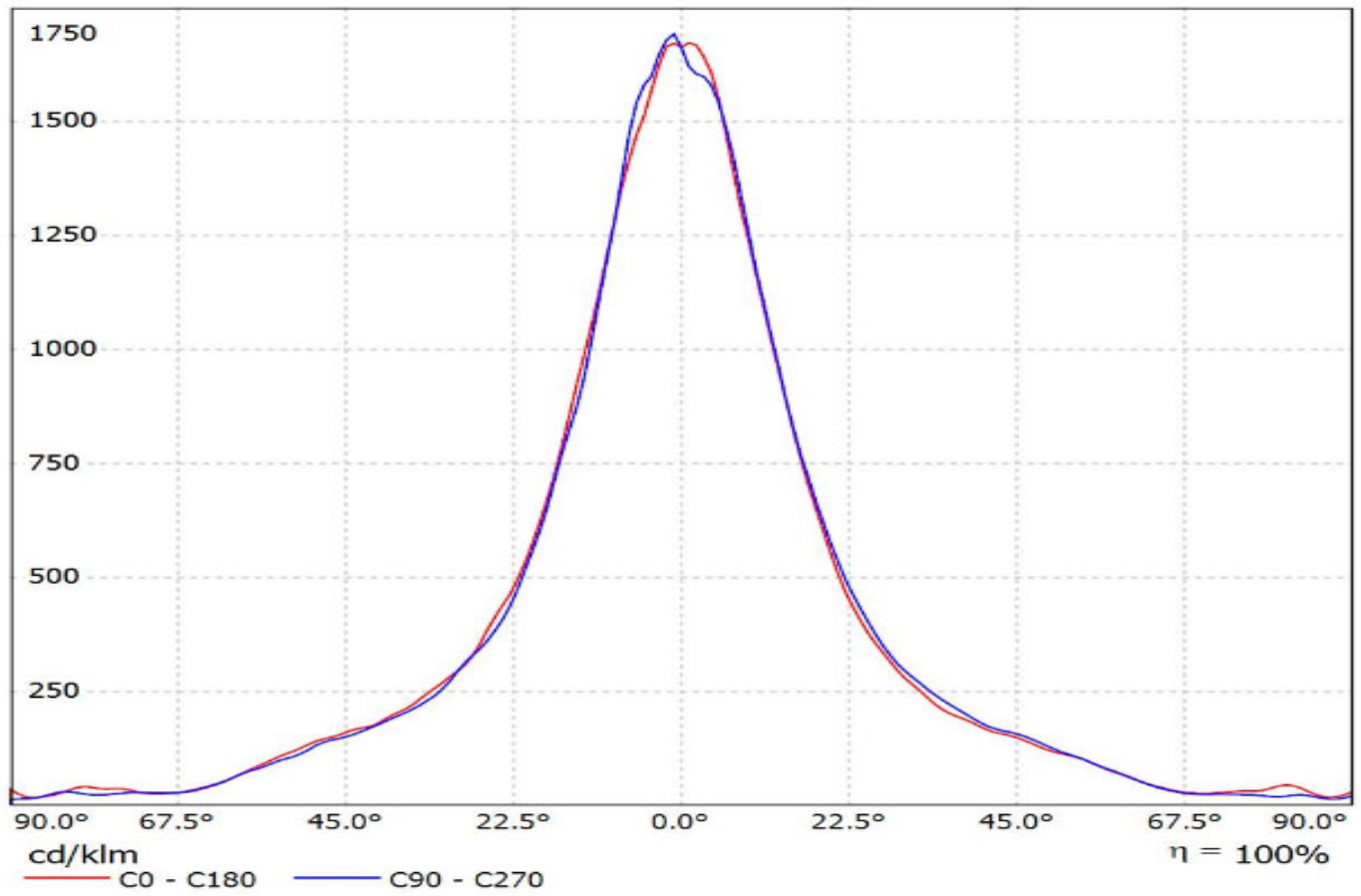

Valaisin: Ledil Oy CS16323_STRADELLA-IP-28-HB-M_(Cree XT-E)_SIMULATED
Lamput: 1 x Cree XT-E (100lm)

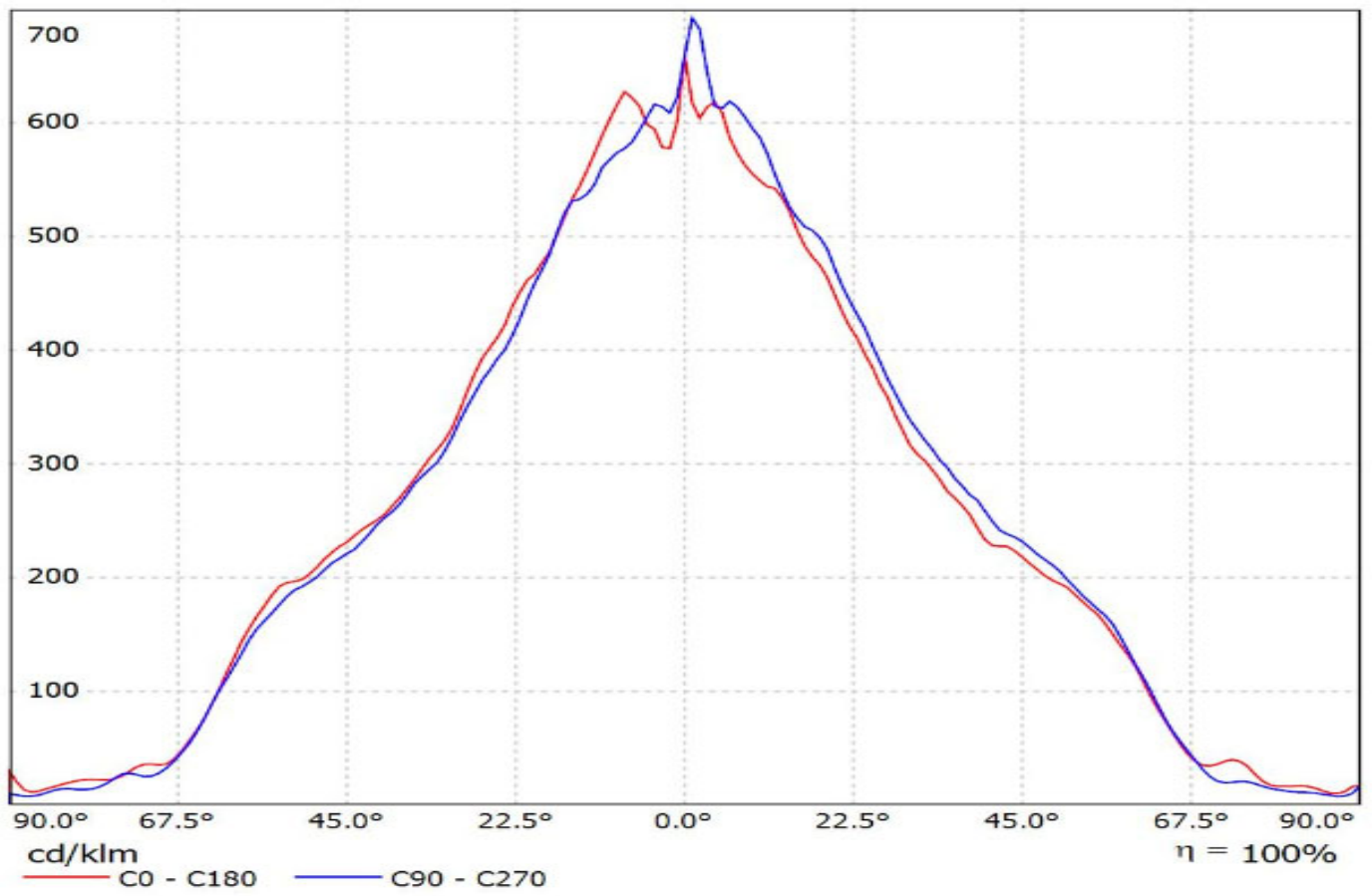

Valaisin: Ledil Oy CS16324_STRADELLA-IP-28-HB-W_(Cree XT-E)_SIMULATED
Lamput: 1 x Cree XT-E (100lm)

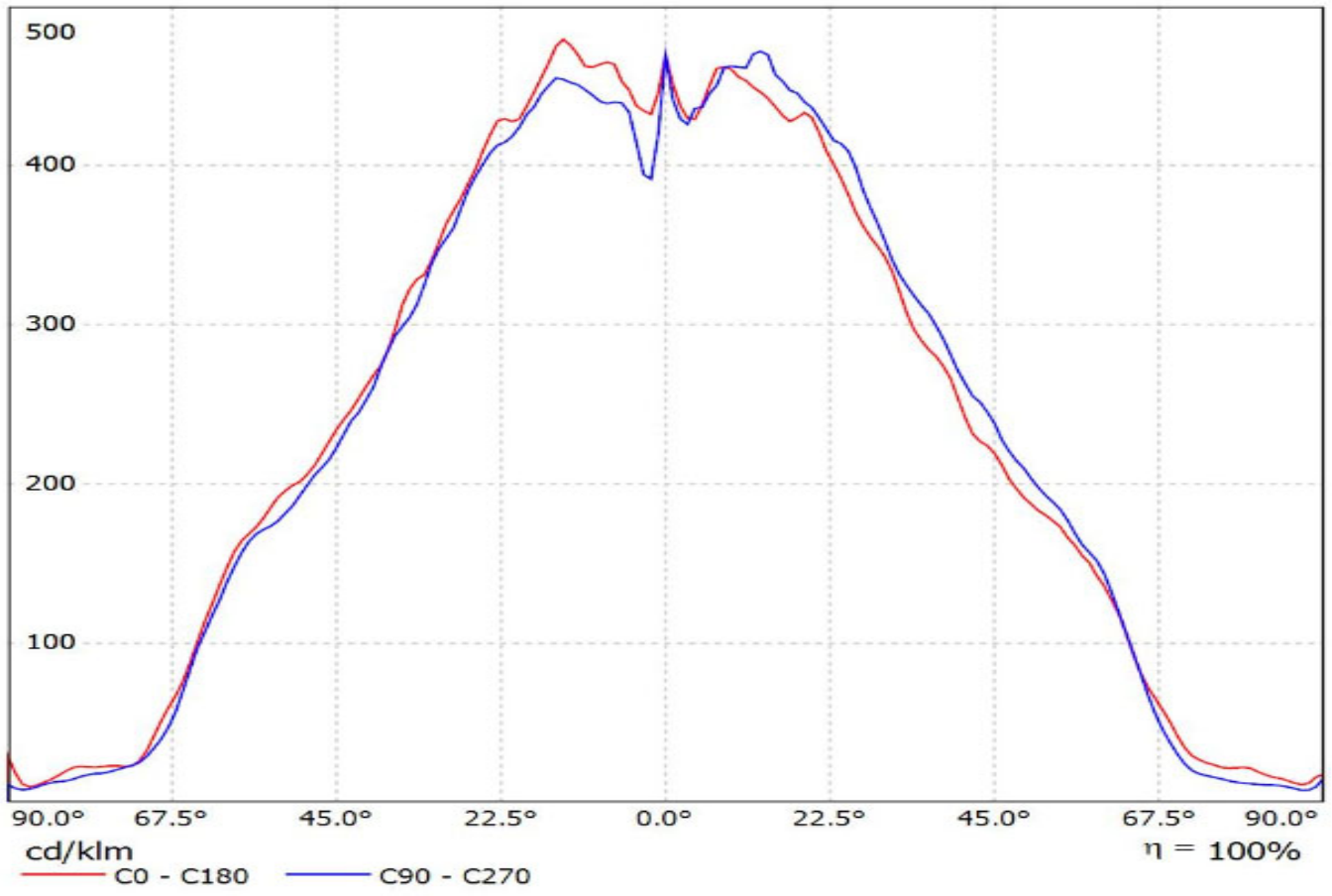

Valaisin: Ledil Oy CS16328_STRADELLA-IP-28-HB-S-PC_(Cree XT-E)_SIMULATED
Lamput: 1 x Cree XT-E (100lm)

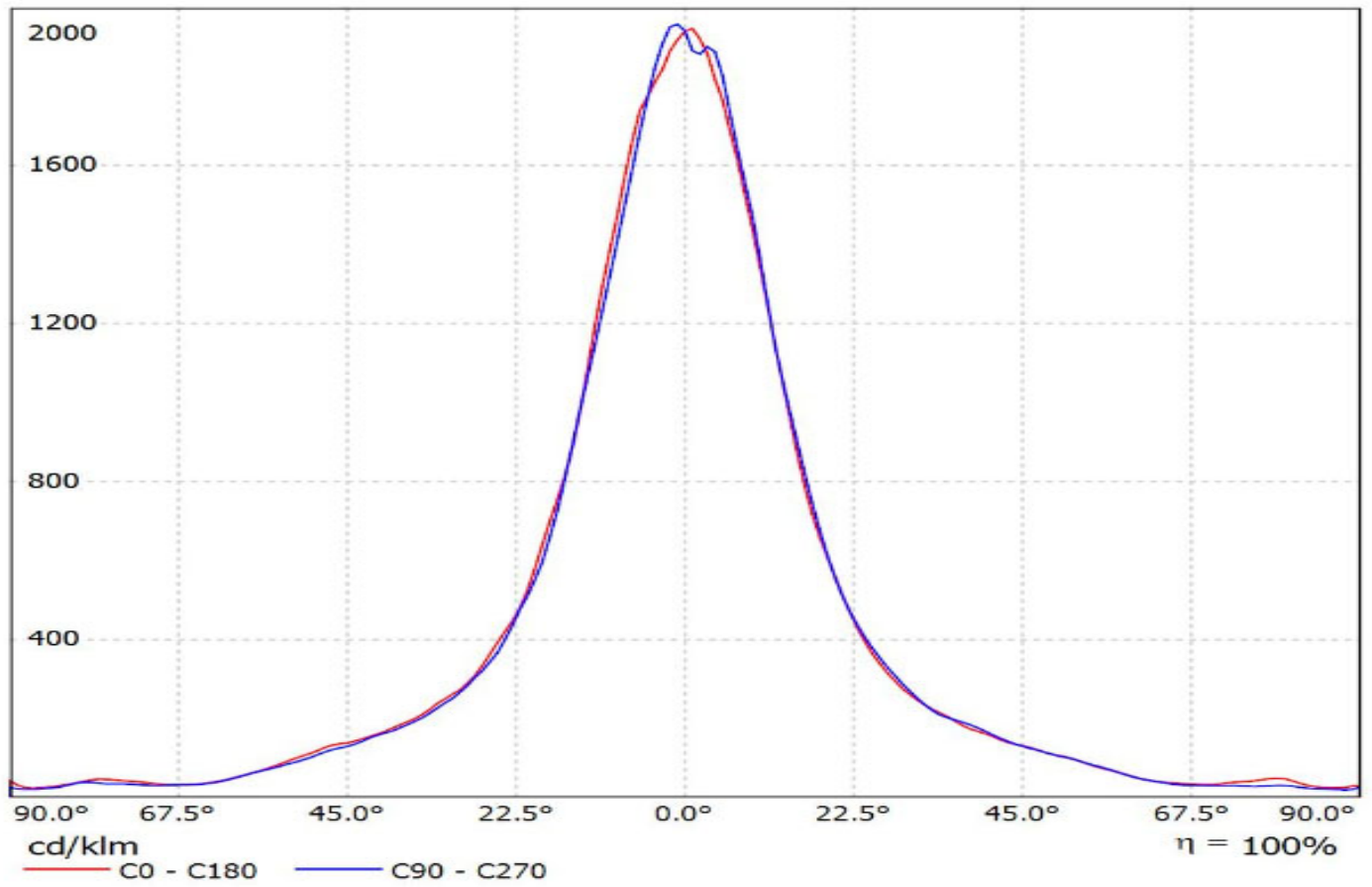

Valaisin: Ledil Oy CS16329_STRADELLA-IP-28-HB-M-PC_(Cree XT-E)_SIMULATED
Lamput: 1 x Cree XT-E (100lm)

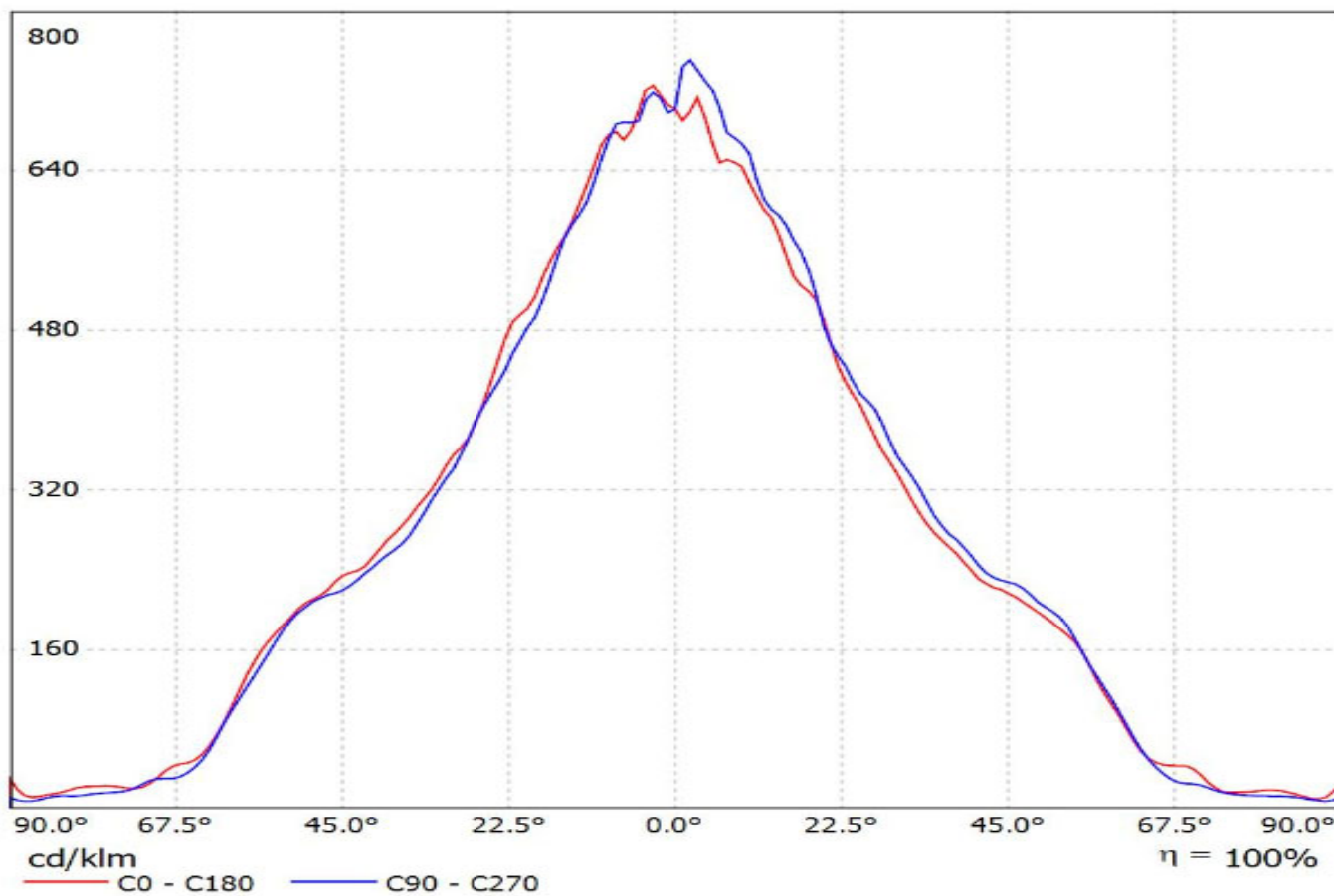

Valaisin: Ledil Oy CS16330_STRADELLA-IP-28-HB-W-PC_(Cree XT-E)_SIMULATED
Lamput: 1 x Cree XT-E (100lm)

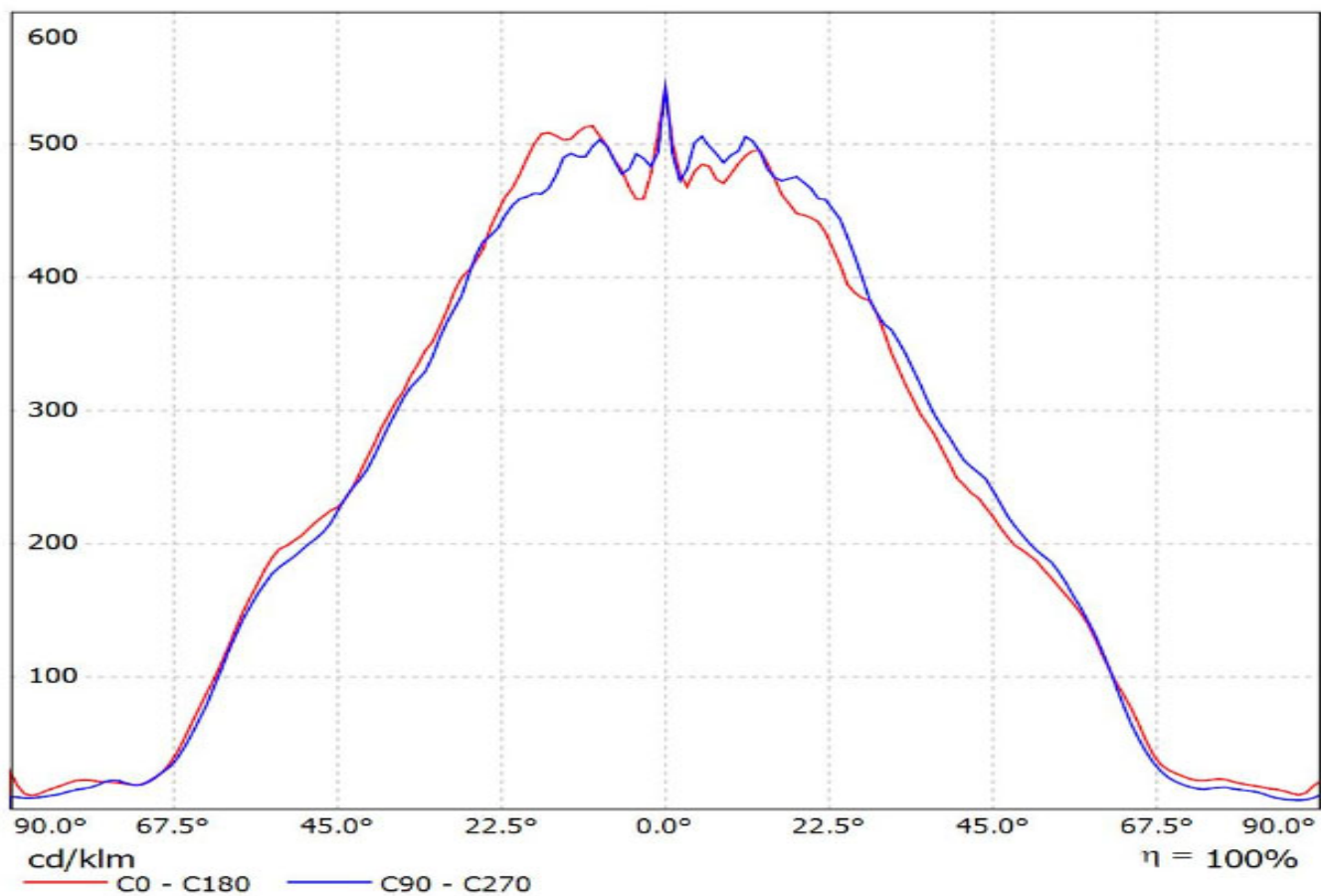

Luminaire: Ledil CS16102_STRADELLA-IP-28-T3_(XT-E)

Lamps: 1 x Cree_XT-E_Stradella-28_1805.68lm@250mA_P=9.51344W_U=38.069V

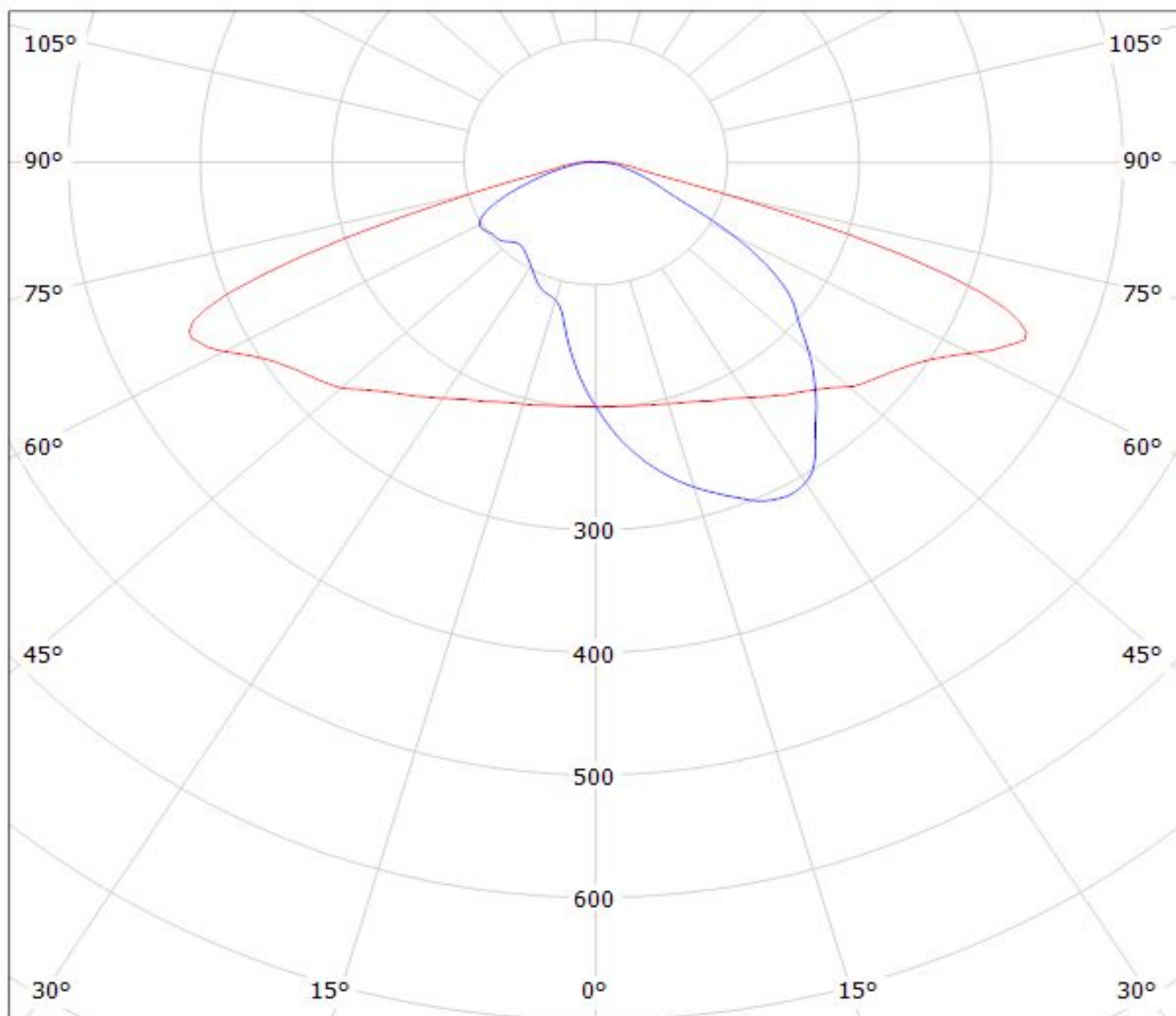

cd/klm

— C0 - C180

— C90 - C270

$\eta = 95\%$

Luminaire: Ledil CS16104_STRADELLA-IP-28-T3-PC_(XT-E)
Lamps: 1 x Cree_XT-E_Stradella-28_1802.62lm@250mA_CCT=5700K_P=9.5072W_U=38.110V

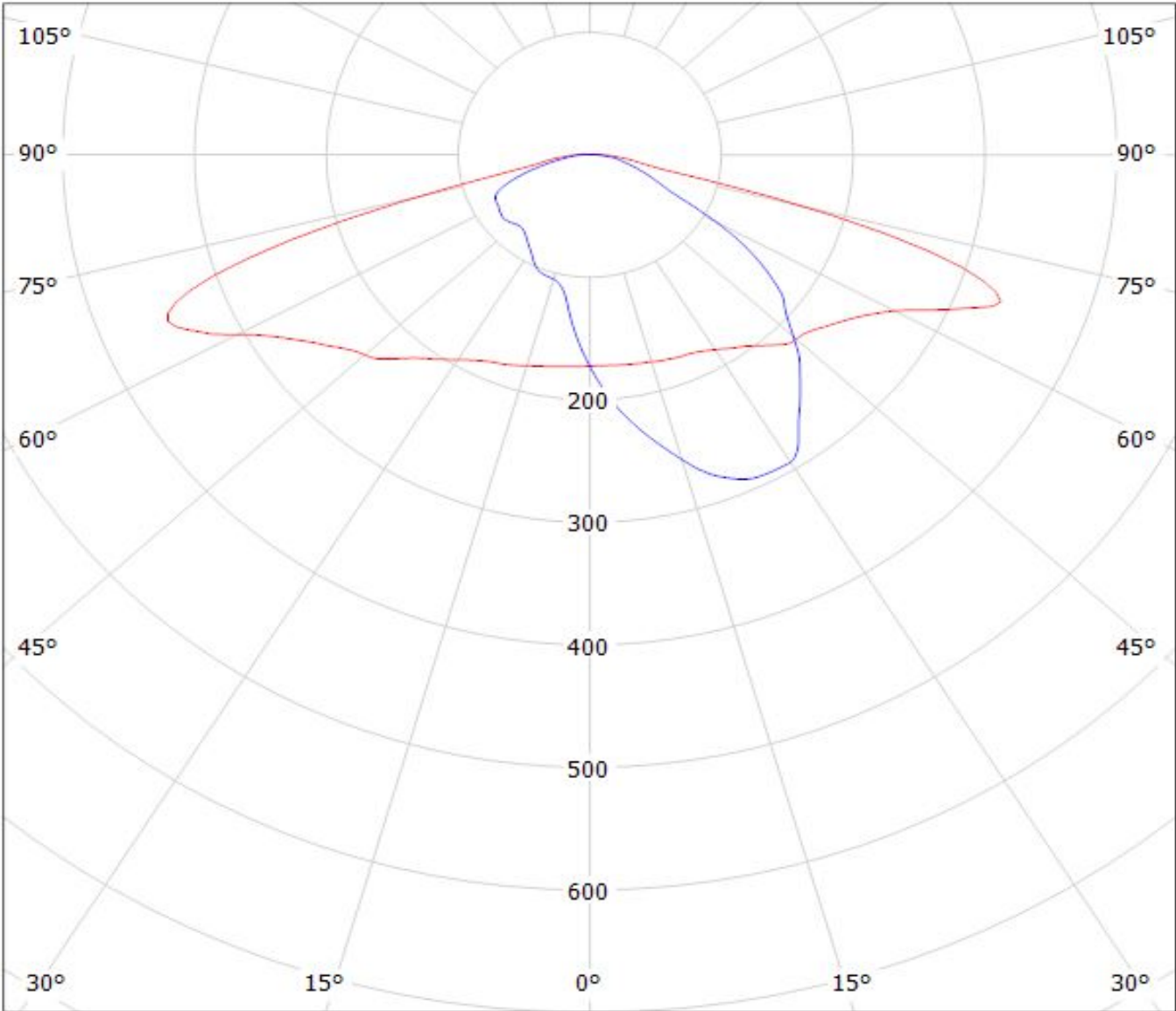

cd/klm

— C0 - C180 — C90 - C270

$\eta = 90\%$

Valaisin: Ledil Oy CS16322_STRADELLA-IP-28-HB-S_(Cree XT-E)_SIMULATED
Lamput: 1 x Cree XT-E (100lm)

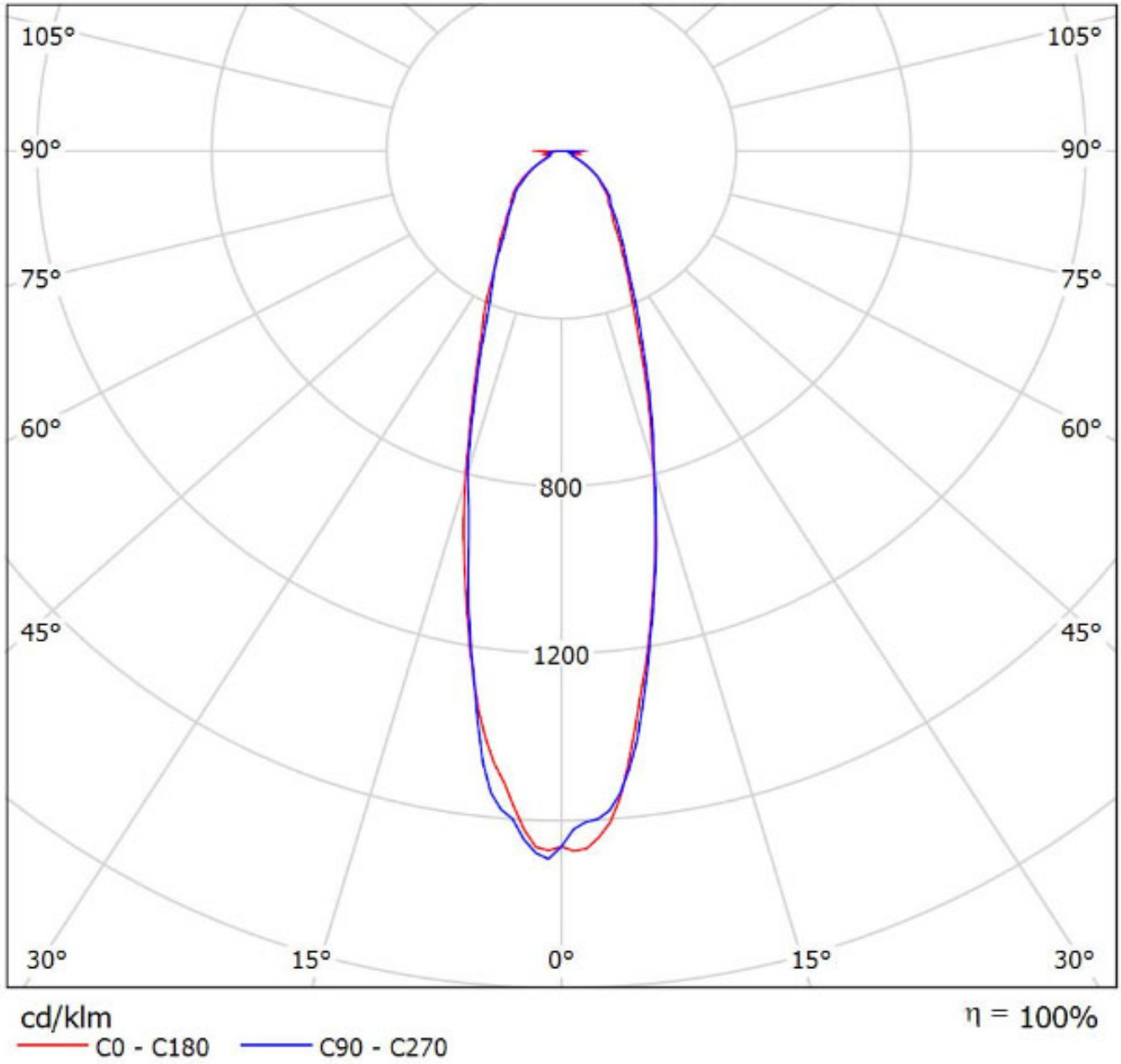

Valaisin: Ledil Oy CS16323_STRADELLA-IP-28-HB-M_(Cree XT-E)_SIMULATED

Lamput: 1 x Cree XT-E (100lm)

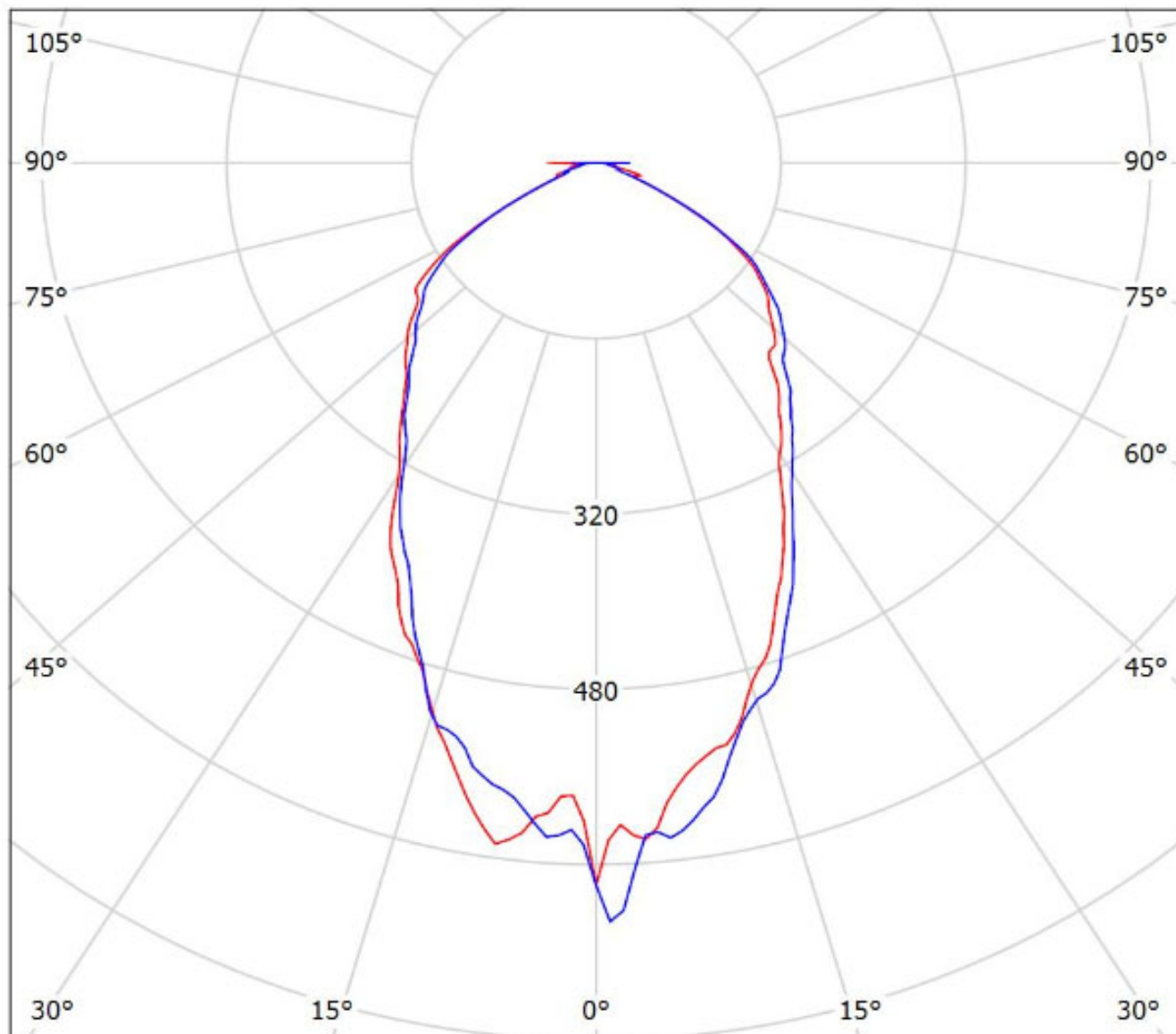

cd/klm

— C0 - C180 — C90 - C270

$\eta = 100\%$

Valaisin: Ledil Oy CS16324_STRADELLA-IP-28-HB-W_(Cree XT-E)_SIMULATED
Lamput: 1 x Cree XT-E (100lm)

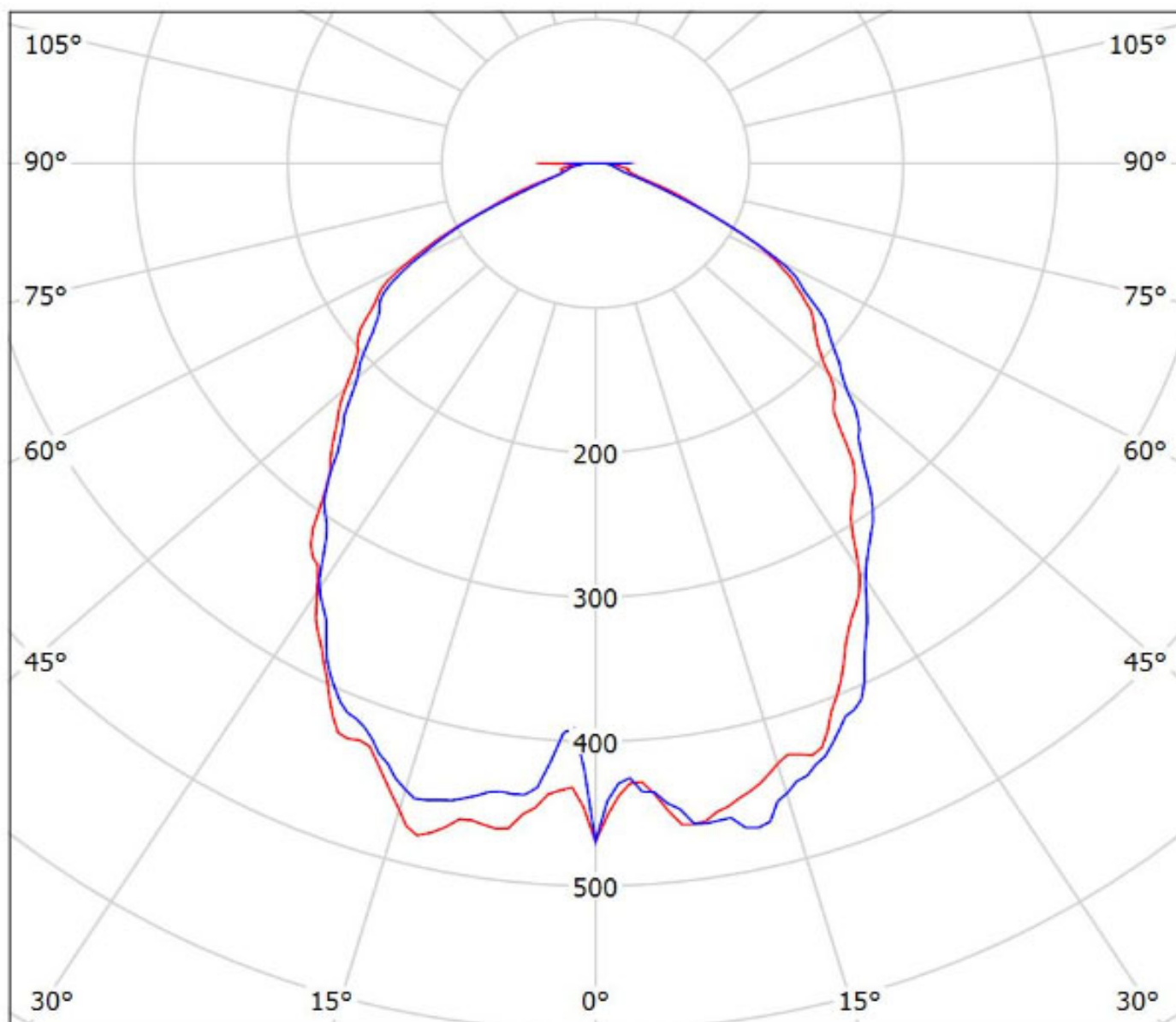

cd/klm

— C0 - C180 — C90 - C270

$\eta = 100\%$

Valaisin: Ledil Oy CS16328_STRADELLA-IP-28-HB-S-PC_(Cree XT-E)_SIMULATED
Lamput: 1 x Cree XT-E (100lm)

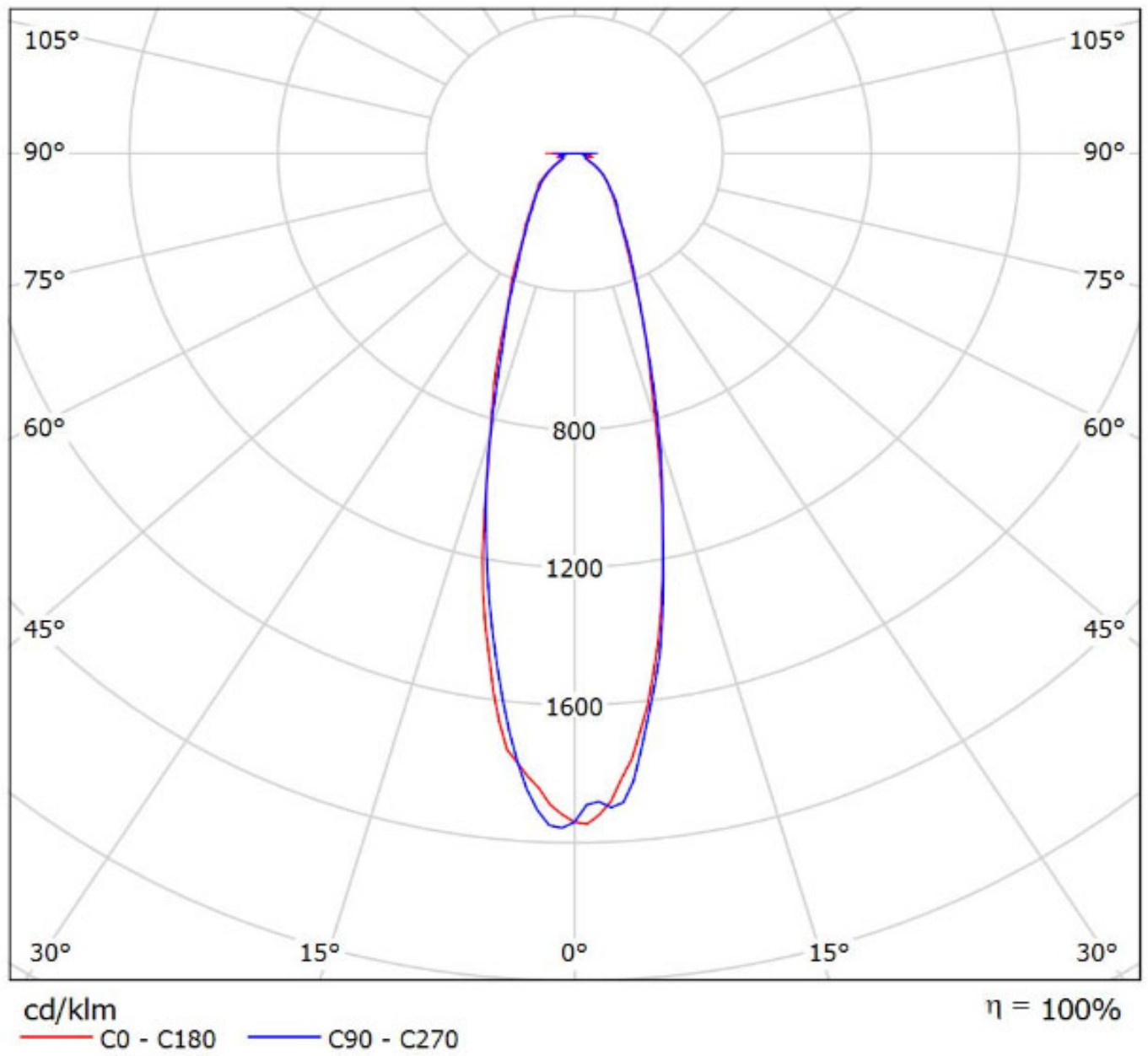

Valaisin: Ledil Oy CS16329_STRADELLA-IP-28-HB-M-PC_(Cree XT-E)_SIMULATED
Lamput: 1 x Cree XT-E (100lm)

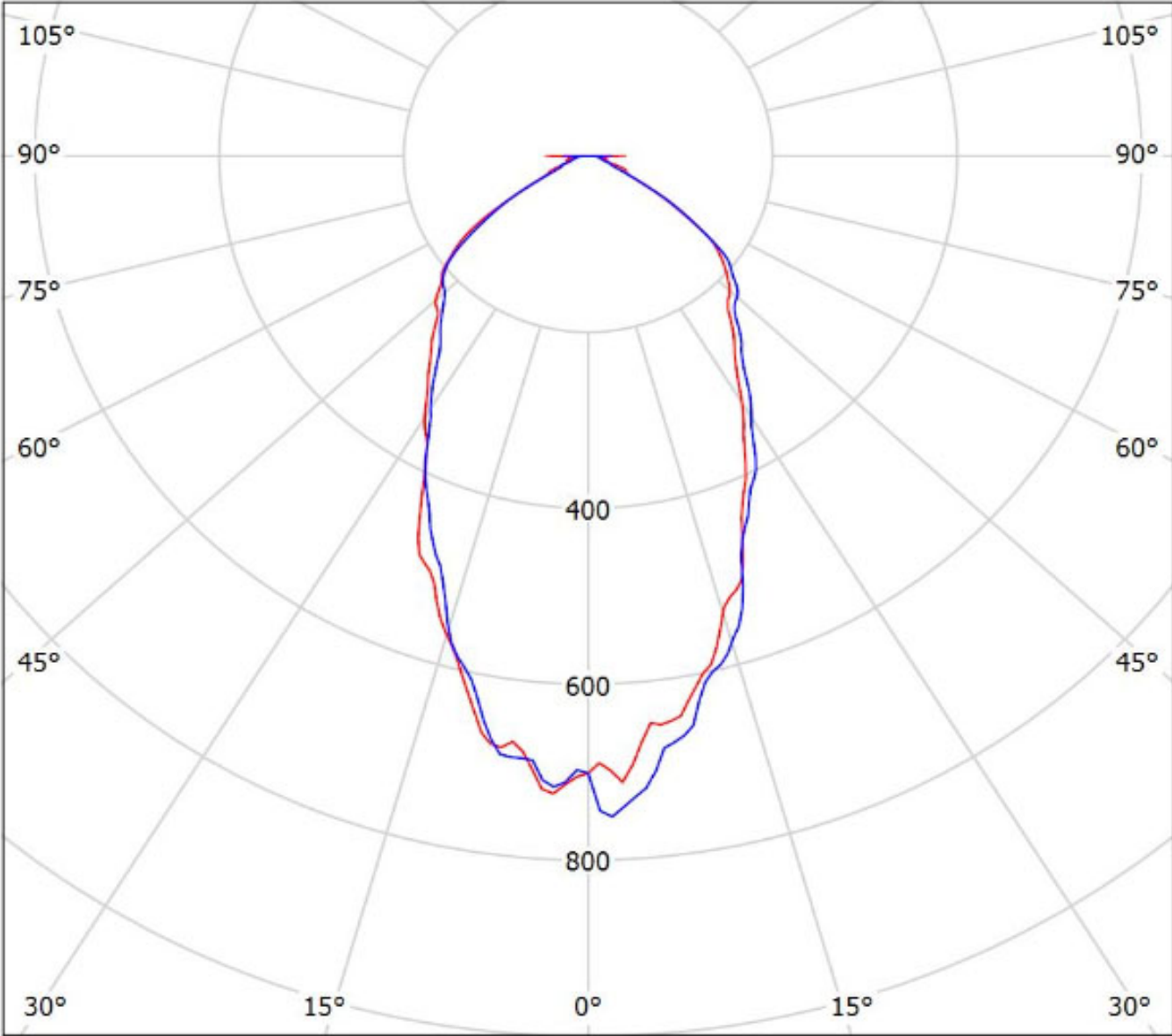

cd/klm
— C0 - C180 — C90 - C270

$\eta = 100\%$

Valaisin: Ledil Oy CS16330_STRADELLA-IP-28-HB-W-PC_(Cree XT-E)_SIMULATED
Lamput: 1 x Cree XT-E (100lm)

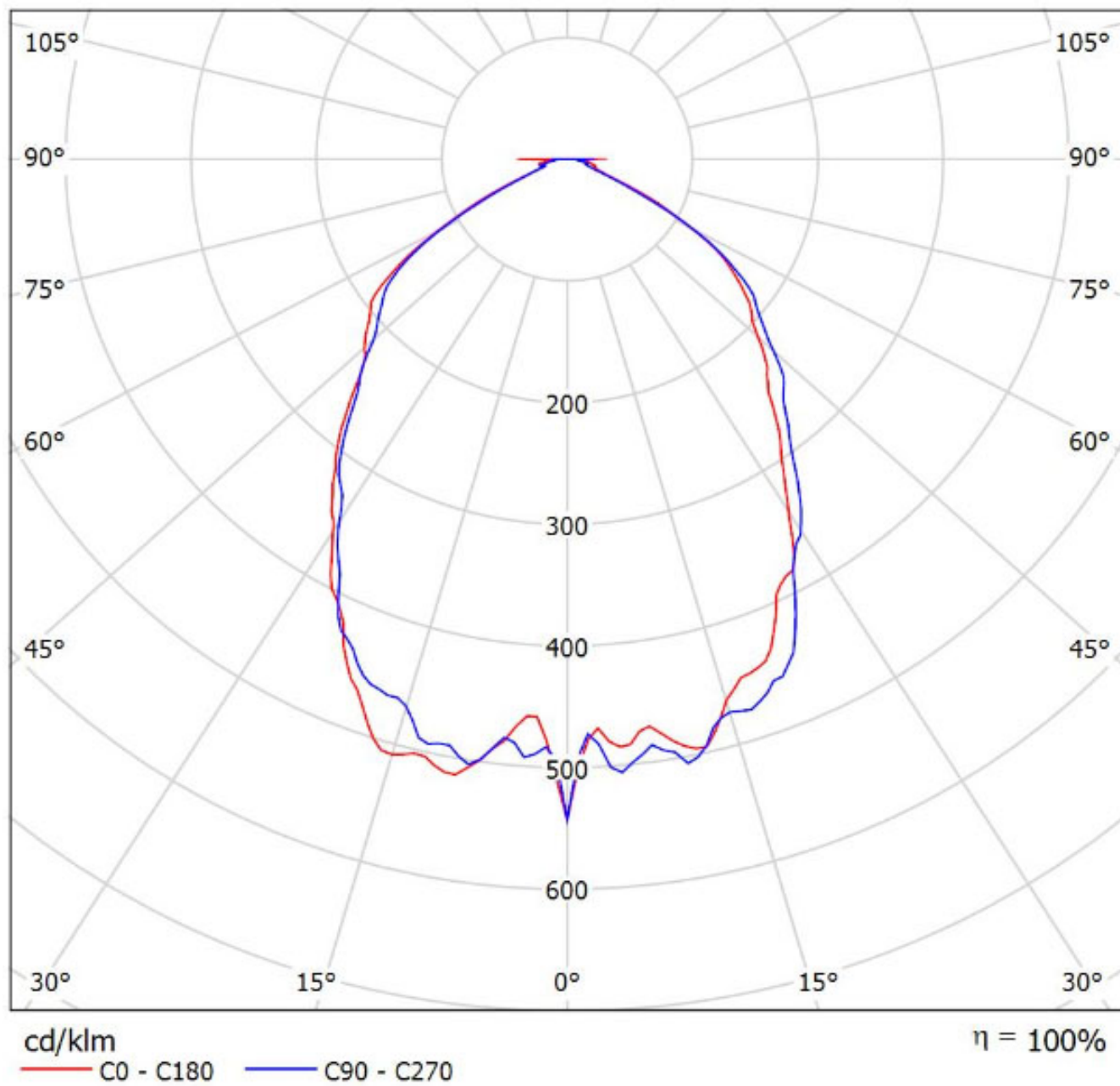

X-ON Electronics

Largest Supplier of Electrical and Electronic Components

Click to view similar products for [LED Lighting Lenses](#) category:

Click to view products by [Ledil](#) manufacturer:

Other Similar products are found below :

[LL01ED-AK40L06](#) [LL01ZZ-EX25L06-M2](#) [180182-0000](#) [FNP-N2-N083-0R NRW](#) [LL01ED-ALI55R49](#) [0190535300](#) [0410111300](#)
[0510113303](#) [0530997](#) [2710121](#) [C11004_TINA2-RS](#) [C12231_LENA-FRESNEL-LENS](#) [LL01ED-AKY24R49](#) [LL01CR-AYG15R49](#)
[LL01CR-OT32L06-M2](#) [LL01ZZ-AAA24L49](#) [LL01CR-CEN38L02](#) [LL01ZZ-AAA55L49](#) [LL01CR-AYG24R49](#) [LL01A00CZMB2-M2](#)
[LL01ED-AKY38R49](#) [LL01CR-CNE2545L06-M2](#) [LL01ZZ-AAA38L49](#) [LL01ED-AKV36R49](#) [LL01ED-ALI24R49](#) [LL01CR-AYG38R49](#)
[FN15973_RONDA-REC-60-C](#) [F16859_LINDA-ZT25](#) [C14169_LENA-CLEAR-LENS](#) [C16125_OLGA-W](#) [C17410_SPORT-2X2-FT6](#)
[C17414_SPORT-2X2-S6](#) [C17409_SPORT-2X2-FT6W](#) [C17360_SPORT-2X2-FT60](#) [C17434_ILONA-WW](#) [F16636_LINDA-W60](#) [10003](#)
[10003/15](#) [10048](#) [10049](#) [10108](#) [CP10960_RGBX-SS](#) [CP12395_LXP3-W](#) [10415](#) [10510](#) [1-1000288-0](#) [F14487_FLORENCE-1R-MAXI-WG](#)
[12667](#) [C14165_STRADA-2X2-ME-WIDE2](#) [C14605_HB-2X2-RW](#)