

BOOM-M

~30° medium beam. Assembly with 0.2 mm thick installation tape.

TECHNICAL SPECIFICATIONS:

| | |
|----------------|-----------|
| Dimensions | Ø 22.2 mm |
| Height | 14.3 mm |
| Fastening | tape |
| ROHS compliant | yes ⓘ |



MATERIAL SPECIFICATIONS:

| Component | Type | Material | Colour | Finish |
|-----------|-----------|----------------|--------|--------|
| BOOM-M | Reflector | PC | metal | |
| BOOM-TAPE | Tape | PU tape 0,25mm | clear | |

ORDERING INFORMATION:

| Component | Type | Qty in box | MOQ | MPQ | Box weight (kg) |
|--------------------------------|-----------|------------|-----|-----|-----------------|
| CA10930_BOOM-M | Reflector | 1680 | 336 | 112 | 5.4 |
| » Box size: 480 x 280 x 300 mm | | | | | |

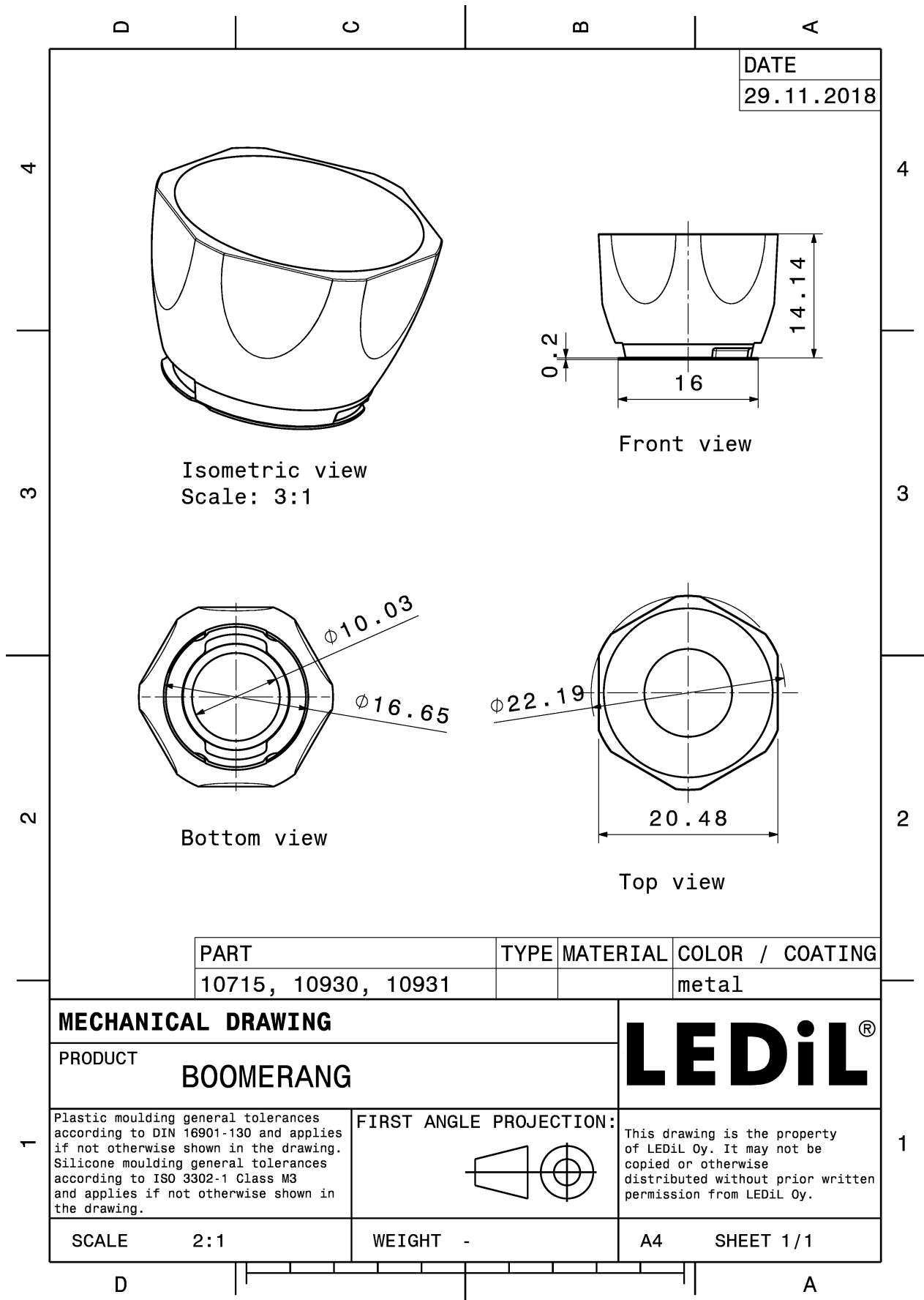

| |
|------------|
| DATE |
| 29.11.2018 |

Isometric view
Scale: 3:1

Front view

Bottom view







Top view

| PART | TYPE | MATERIAL | COLOR / COATING |
|---------------------|------|----------|-----------------|
| 10715, 10930, 10931 | | | metal |

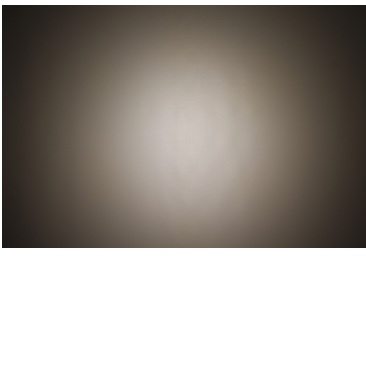
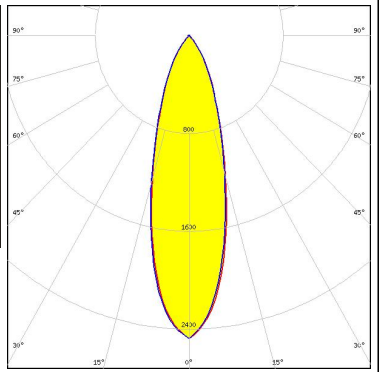

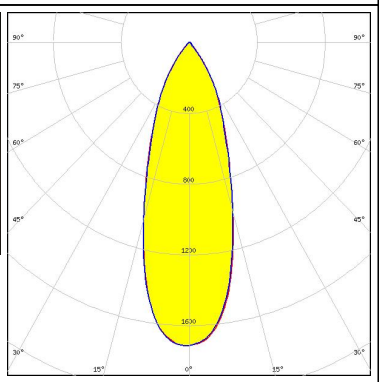

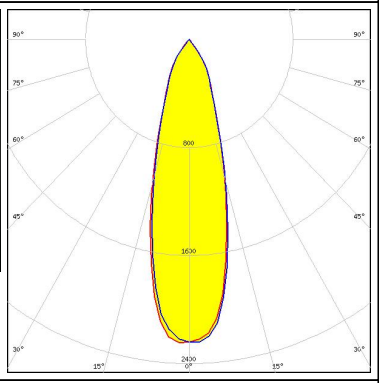
| | | |
|--|-----------------------------|---|
| MECHANICAL DRAWING | | LEDiL® |
| PRODUCT BOOMERANG | | |
| Plastic moulding general tolerances according to DIN 16901-130 and applies if not otherwise shown in the drawing. Silicone moulding general tolerances according to ISO 3302-1 Class M3 and applies if not otherwise shown in the drawing. | FIRST ANGLE PROJECTION: | This drawing is the property of LEDiL Oy. It may not be copied or otherwise distributed without prior written permission from LEDiL Oy. |
| SCALE 2:1 | WEIGHT - | |

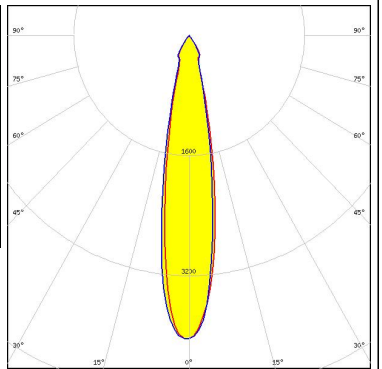
See also our general installation guide: www.ledil.com/installation_guide

PHOTOMETRIC DATA (MEASURED):

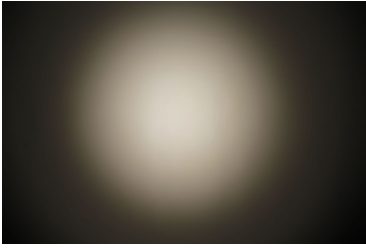
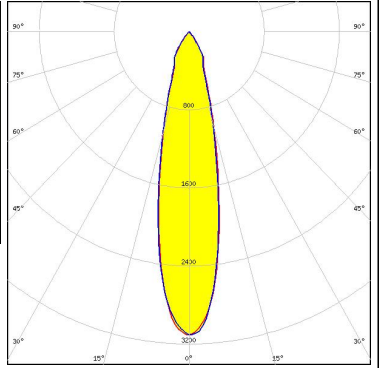
| | | |
|--|--|---|
| <p>CREE LED</p> <p>LED MHB-A/B FWHM / FWTM 31.0° / 70.0° Efficiency 82 % Peak intensity 2.2 cd/lm LEDs/each optic 1 Light colour White Required components:</p> |  |  |
| <p>CREE LED</p> <p>LED MHD-E/G FWHM / FWTM 34.0° / 72.0° Efficiency 82 % Peak intensity 1.7 cd/lm LEDs/each optic 1 Light colour White Required components:</p> |  |  |
| <p>LUMILEDS</p> <p>LED LUXEON M/MX FWHM / FWTM 30.0° / 66.0° Efficiency 79 % Peak intensity 2.2 cd/lm LEDs/each optic 1 Light colour White Required components:</p> |  |  |
| <p>LUMILEDS</p> <p>LED LUXEON MZ FWHM / FWTM 20.0° / 41.0° Efficiency 75 % Peak intensity 4 cd/lm LEDs/each optic 1 Light colour White Required components:</p> |  |  |

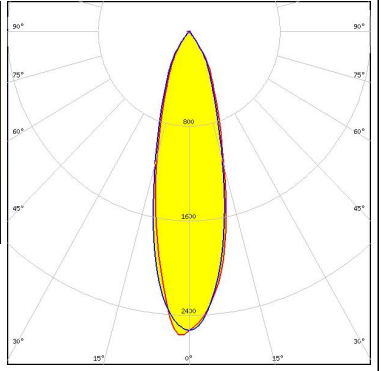
PHOTOMETRIC DATA (MEASURED):

| | | |
|---|--|---|
| <p>NICHIA</p> <p>LED NFMW48xA FWHM / FWTM 23.0° / 59.0° Efficiency 80 % Peak intensity 3.1 cd/lm LEDs/each optic 1 Light colour White Required components:</p> |  |  |
| <p>OSRAM Opto Semiconductors</p> <p>LED Duris S10 FWHM / FWTM 28.0° / 65.0° Efficiency 74 % Peak intensity 2.5 cd/lm LEDs/each optic 1 Light colour White Required components:</p> |  |  |
| <p>SEOUL SEMICONDUCTOR</p> <p>LED P7 FWHM / FWTM 33.0° / 74.0° Efficiency % Peak intensity 1.9 cd/lm LEDs/each optic 1 Light colour White Required components:</p> |  |  |

PHOTOMETRIC DATA (SIMULATED):

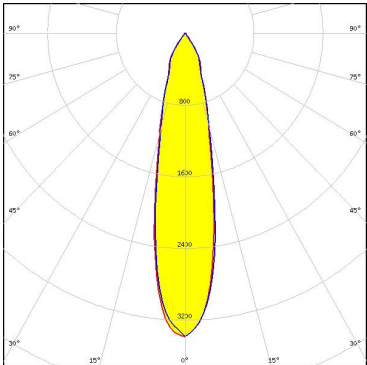
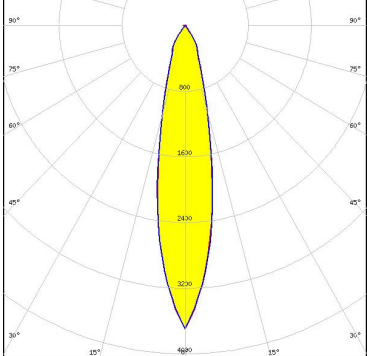
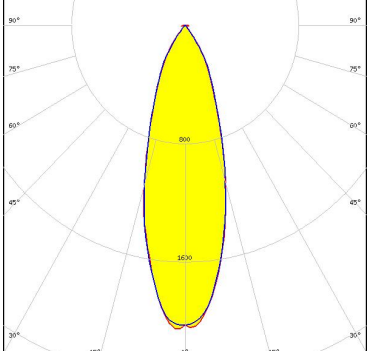
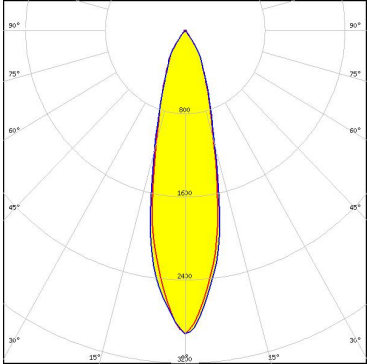
| | |
|--|---|
| <p>CREE LED</p> <p>LED MC-E FWHM / FWTM 23.0° / 60.0° Efficiency 90 % Peak intensity 3.4 cd/lm LEDs/each optic 1 Light colour White Required components:</p> |  |
| <p>LUMILEDS</p> <p>LED LUXEON 5050 Round LES FWHM / FWTM 22.0° / 52.0° Efficiency 86 % Peak intensity 3.7 cd/lm LEDs/each optic 1 Light colour White Required components:</p> |  |
| <p>NICHIA</p> <p>LED COB S-Type (LES 7) FWHM / FWTM 31.6° / 67.0° Efficiency 82 % Peak intensity 2.1 cd/lm LEDs/each optic 1 Light colour White Required components:</p> |  |
| <p>OSRAM <small>Opto Semiconductors</small></p> <p>LED Duris S8 FWHM / FWTM 25.7° / 61.7° Efficiency 87 % Peak intensity 2.9 cd/lm LEDs/each optic 1 Light colour White Required components:</p> |  |

PHOTOMETRIC DATA (SIMULATED):

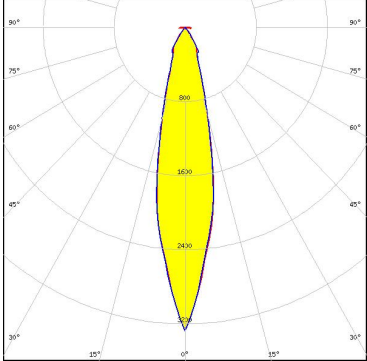
| | |
|--|--|
| <p>OSRAM Opto Semiconductors</p> <p>LED OSCONIQ P 7070</p> <p>FWHM / FWTM 25.0° / 63.0°</p> <p>Efficiency 85 %</p> <p>Peak intensity 3.3 cd/lm</p> <p>LEDs/each optic 1</p> <p>Light colour White</p> <p>Required components:</p> |  |
| <p>SEOUL SEOUL SEMICONDUCTOR</p> <p>LED Z8Y19</p> <p>FWHM / FWTM 22.0° / 50.0°</p> <p>Efficiency 79 %</p> <p>Peak intensity 3.3 cd/lm</p> <p>LEDs/each optic 4</p> <p>Light colour White</p> <p>Required components:</p> |  |

GENERAL INFORMATION:

NOTE: The typical beam angle will be changed by different color, chip size and chip position tolerance. The typical total beam angle is the full angle measured where the luminous intensity is half of the peak value.

Due to use of high power COB's with this product, special attention to proper thermal design is highly recommended. LEDiL has no liability for direct, indirect or consecutive damages arising from the LEDiL products being used outside of the recommended temperature range.

MATERIALS:

As part of our continuous research and improvement processes, and to ensure the best possible quality and availability of our products, LEDiL reserves the right to change material grades without notice.

PRODUCT DATA USER AGREEMENT AND DISCLAIMER:

The measured data in the provided downloadable LEDiL Product Datasheets and Mechanical 2D-Drawings is rounded and provided as reference for planning. LEDiL Oy's optical specifications have been verified by conducting performance testing of the products in accordance with the company's quality system. The reported data are averaged results of multiple measurements with typical variation. LEDiL Oy reserves the right to without prior notification make changes and improvements to its products.

LEDiL Oy assumes neither warranty, nor guarantee nor any other liability of any kind for the contents and correctness of the provided data. The provided data has been generated with highest diligence but the provided data may in reality not represent the complete possible variation range of all intrinsic parameters. Therefore, in certain cases a deviation from the provided data could occur.

LEDiL Oy reserves the right to undertake technical changes of its products without further notification which could lead to changes in the provided data. LEDiL Oy assumes no liability of any kind for the possible deviation from any provided data or any other damage resulting from the usage of the provided data.

The user agrees to this disclaimer and user agreement with the download or usage of the provided files.

LEDiL Oy

Joensuunkatu 13
FI-24240 SALO
Finland

LEDiL Inc.

228 West Page Street
Suite D
Sycamore IL 60178
USA

Ledil Optics Technology (Shenzhen) Co., Ltd.

405 , Block B
Casic Motor Building
Shenzhen 518057
P.R.CHINA

Local sales and technical support

[www.ledil.com/
where_to_buy](http://www.ledil.com/where_to_buy)

Shipping locations

Salo, Finland
Hong Kong, China

Distribution Partners

[www.ledil.com/
where_to_buy](http://www.ledil.com/where_to_buy)

X-ON Electronics

Largest Supplier of Electrical and Electronic Components

Click to view similar products for [LED Lighting Reflectors](#) category:

Click to view products by [Ledil](#) manufacturer:

Other Similar products are found below :

[LL04CR-CFN35155L02](#) [LL04CR-CFN60155L02](#) [LL04CR-CGM85135L02](#) [F13185_GERI-RZ](#) [10604](#) [LL01SP-ATH15R49](#) [10170](#) [12527](#)
[12531](#) [12568](#) [C13253_TINA2-R-CLIP16](#) [CA14591_BROOKE-XW](#) [F15560_MIRELLA-G2-W](#) [CA11525_LAURA-R-W](#) [12796](#) [LMH020-](#)
[REFL-0000-0000062](#) [LMH020-REFL-0000-0000082](#) [C12606_LENINA-DL](#) [CN12711_LENINA-W-DL](#) [C11394_TYRA-S](#) [C11396_TYRA-](#)
[W](#) [C11508_BROOKE-W](#) [C11552_BARBARA-S](#) [C11553_BARBARA-W](#) [C11862_MINNIE-W](#) [C11979_LENA-S](#) [C11980_LENA-W](#)
[C11996_LENA-LENS](#) [C12083_BROOKE-SCR-M](#) [C12095_MINNIE-M](#) [C12097_MINNIE-WWW](#) [C12154_LENA-M](#) [C12469_LISA2-R-](#)
[PIN](#) [C12476_MIRELLA-50-S](#) [C12477_MIRELLA-50-M](#) [C12480_MIRELLA-50-S-PIN](#) [C12516_RITA-WAS](#) [C12597_LENINA-S](#)
[C12599_LENINA-W](#) [C12948_LENA-WAS](#) [C12958_LENINA-XW](#) [C13085_MIRELLA-50-S-PF](#) [C13087_MIRELLA-50-W-PF](#)
[C13101_LENA-X-WAS](#) [C13555_BRIDGET-W-UNI](#) [C13556_BRIDGET-M-UNI](#) [C13557_BRIDGET-S-UNI](#) [C14346_ANGELETTE-WAS](#)
[C17099_ALISE-50-DL](#) [C17095_ALISE-70-CL](#)