

HEIDI-M

~25° medium beam

TECHNICAL SPECIFICATIONS:

Dimensions	Ø 21.6 mm
Height	11.9 mm
Fastening	tape, pin
ROHS compliant	yes ⓘ

MATERIAL SPECIFICATIONS:

Component	Type	Material	Colour	Finish
HEIDI-M	Single lens	PMMA	clear	
HEIDI-TAPE	Tape	PU tape	black	

ORDERING INFORMATION:

Component		Qty in box	MOQ	MPQ	Box weight (kg)
CA11265_HEIDI-M	Single lens	3264	204	204	10.8
» Box size: 480 x 280 x 300 mm					

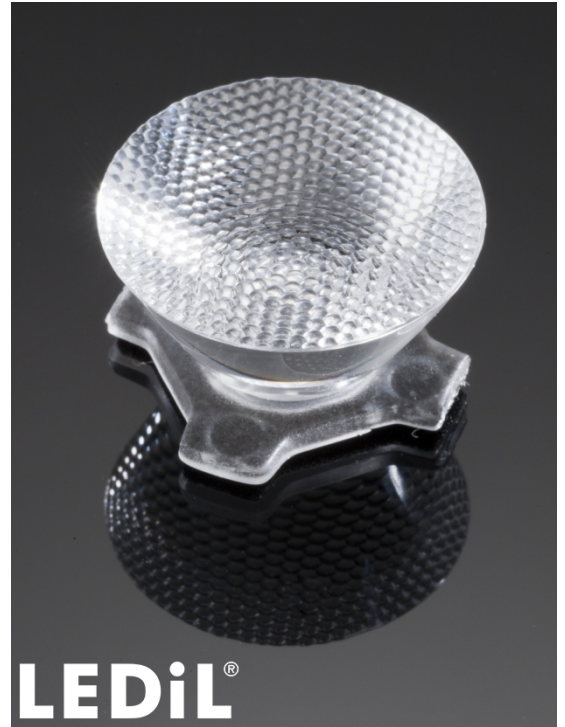

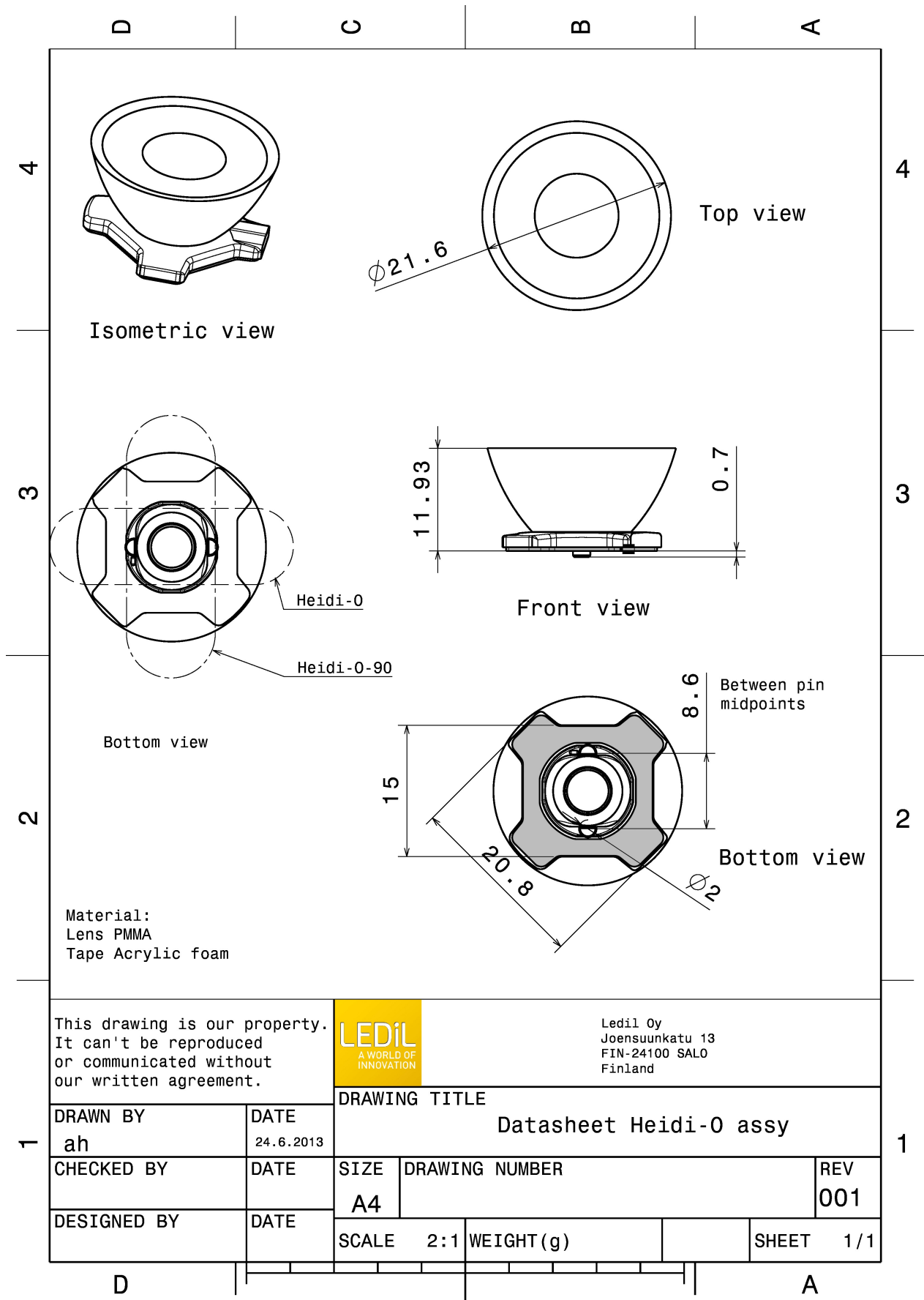

See also our general installation guide: www.ledil.com/installation_guide

PHOTOMETRIC DATA (MEASURED):

CREE → LED

LED XB-D White
FWHM / FWTM 29.0°
Efficiency 87 %
Peak intensity 2 cd/lm
LEDs/each optic 1
Light colour White
Required components:

CREE → LED

LED XB-H
FWHM / FWTM 27.0° / 48.0°
Efficiency 87 %
Peak intensity 3.4 cd/lm
LEDs/each optic 1
Light colour White
Required components:



CREE → LED

LED XP-E
FWHM / FWTM 28.0° / 46.0°
Efficiency 92 %
Peak intensity 2.9 cd/lm
LEDs/each optic 1
Light colour White
Required components:

CREE → LED

LED XP-G
FWHM / FWTM 28.0° / 46.0°
Efficiency 92 %
Peak intensity 3.3 cd/lm
LEDs/each optic 1
Light colour White
Required components:

PHOTOMETRIC DATA (MEASURED):

CREE LED

LED XQ-E HD
 FWHM / FWTM 26.0° / 41.0°
 Efficiency 94 %
 Peak intensity 4.1 cd/lm
 LEDs/each optic 1
 Light colour White
 Required components:

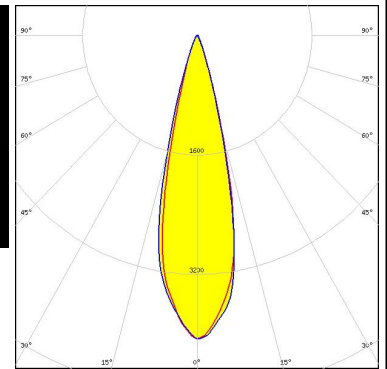

CREE LED

LED XQ-E HI
 FWHM / FWTM 25.0° / 40.0°
 Efficiency 94 %
 Peak intensity 4.2 cd/lm
 LEDs/each optic 1
 Light colour White
 Required components:

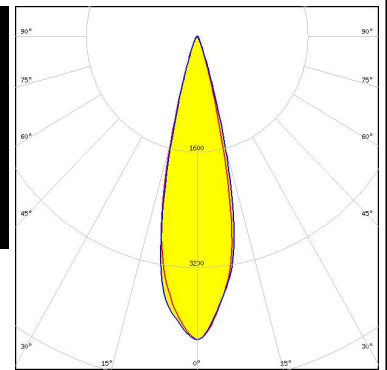
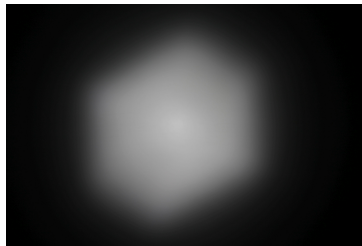

CREE LED

LED XT-E
 FWHM / FWTM 27.0° / 46.0°
 Efficiency 94 %
 Peak intensity 3.5 cd/lm
 LEDs/each optic 1
 Light colour White
 Required components:

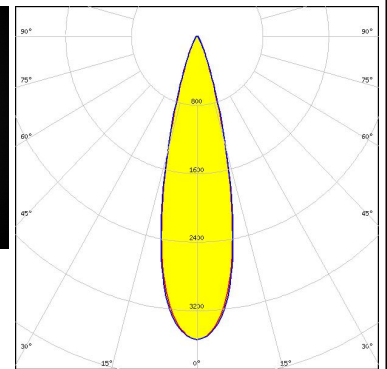
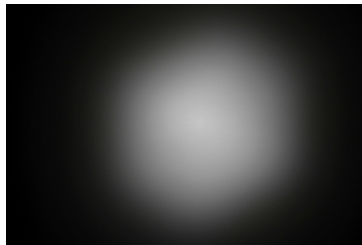

LUMILEDS

LED LUXEON C
 FWHM / FWTM 26.0° / 44.0°
 Efficiency 87 %
 Peak intensity 4 cd/lm
 LEDs/each optic 1
 Light colour White
 Required components:

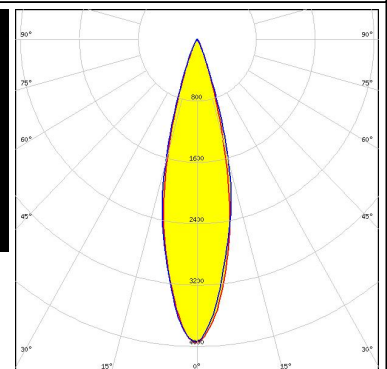
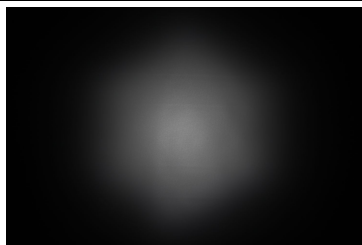

PHOTOMETRIC DATA (MEASURED):

LUMILEDS

LED LUXEON CZ
 FWHM / FWTM 26.0° / 42.0°
 Efficiency 94 %
 Peak intensity 4.5 cd/m
 LEDs/each optic 1
 Light colour White
 Required components:

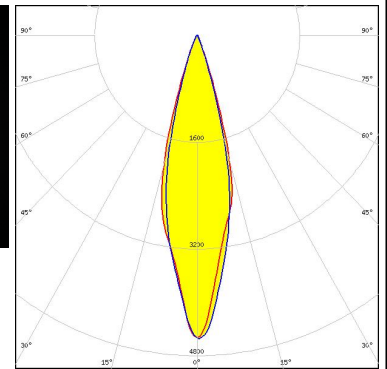

LUMILEDS

LED LUXEON T
 FWHM / FWTM 28.0° / 47.0°
 Efficiency 87 %
 Peak intensity 3.3 cd/m
 LEDs/each optic 1
 Light colour White
 Required components:

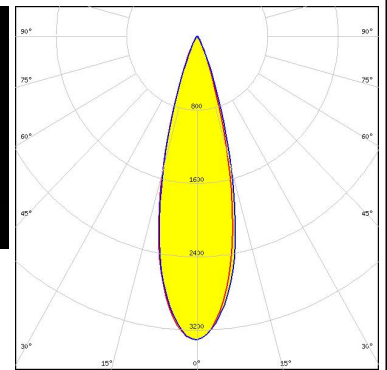

LUMILEDS

LED LUXEON TX
 FWHM / FWTM 29.0° / 48.0°
 Efficiency 88 %
 Peak intensity 3.4 cd/m
 LEDs/each optic 1
 Light colour White
 Required components:

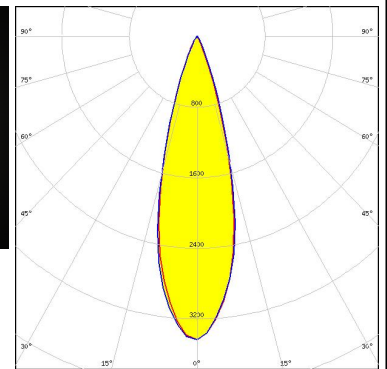
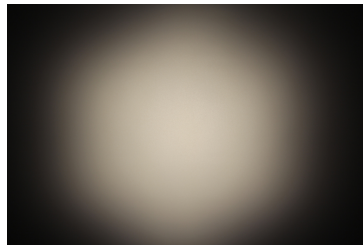

NICHIA

LED NCSxx19B
 FWHM / FWTM 29.0° / 47.0°
 Efficiency 88 %
 Peak intensity 3.7 cd/m
 LEDs/each optic 1
 Light colour White
 Required components:

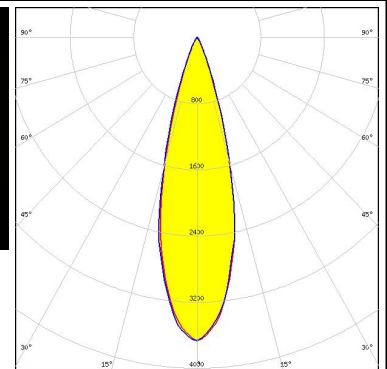

PHOTOMETRIC DATA (MEASURED):



LED NVSxx19A
FWHM / FWTM 28.0° / 49.0°
Efficiency 87 %
Peak intensity 3.1 cd/lm
LEDs/each optic 1
Light colour White
Required components:



LED OSLOM SSL 150
FWHM / FWTM 26.0° / 44.0°
Efficiency 90 %
Peak intensity 3.4 cd/lm
LEDs/each optic 1
Light colour White
Required components:



LED OSLOM SSL 80
FWHM / FWTM 28.0° / 46.0°
Efficiency 87 %
Peak intensity 3.1 cd/lm
LEDs/each optic 1
Light colour White
Required components:



LED Fortimo FastFlex 2x8 DS G3
FWHM / FWTM 25.0° / 42.0°
Efficiency 90 %
Peak intensity 4 cd/lm
LEDs/each optic 1
Light colour White
Required components:

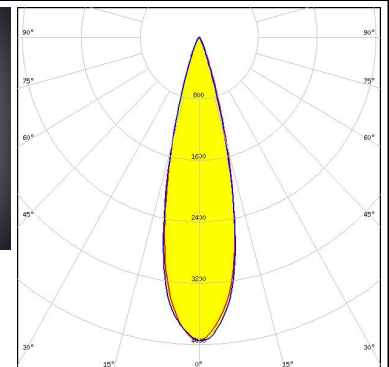
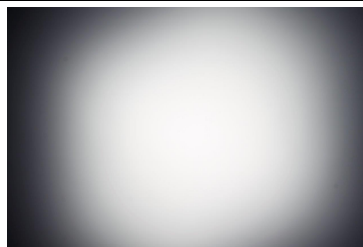

PHOTOMETRIC DATA (MEASURED):

SAMSUNG

LED LH181A
 FWHM / FWTM 27.0° / 49.0°
 Efficiency 88 %
 Peak intensity 2.9 cd/m
 LEDs/each optic 1
 Light colour White
 Required components:

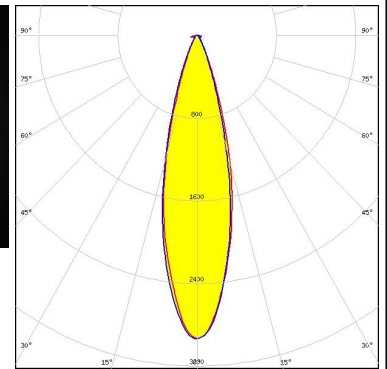
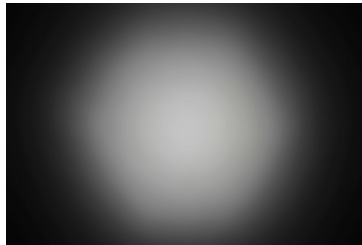

SAMSUNG

LED LH181B
 FWHM / FWTM 27.0° / 49.0°
 Efficiency 93 %
 Peak intensity 3.4 cd/m
 LEDs/each optic 1
 Light colour White
 Required components:

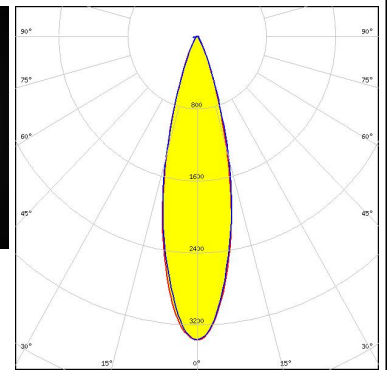
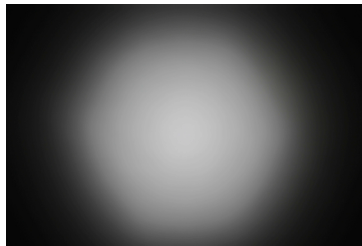

SEOUL SEMICONDUCTOR

LED Z5
 FWHM / FWTM 28.0° / 42.0°
 Efficiency 87 %
 Peak intensity 3.7 cd/m
 LEDs/each optic 1
 Light colour White
 Required components:



SEOUL SEMICONDUCTOR

LED Z5M1/Z5M2
 FWHM / FWTM 29.0° / 48.0°
 Efficiency 89 %
 Peak intensity 3.4 cd/m
 LEDs/each optic 1
 Light colour White
 Required components:

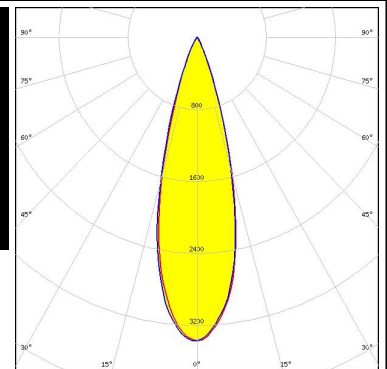
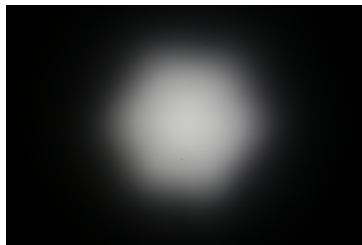

PHOTOMETRIC DATA (SIMULATED):



LED XP-E2
 FWHM / FWTM 29.0° / 46.0°
 Efficiency 96 %
 Peak intensity 3.8 cd/lm
 LEDs/each optic 1
 Light colour Green
 Required components:

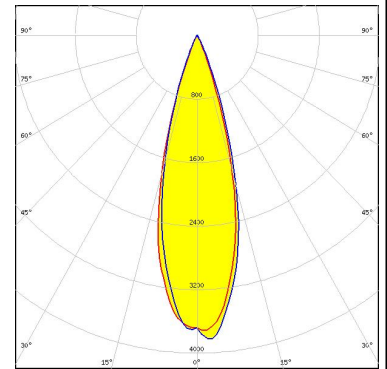

LED LUXEON SunPlus 20 Line (150 deg)
 FWHM / FWTM 28.0° / 45.0°
 Efficiency 91 %
 Peak intensity 3.7 cd/lm
 LEDs/each optic 1
 Light colour White
 Required components:

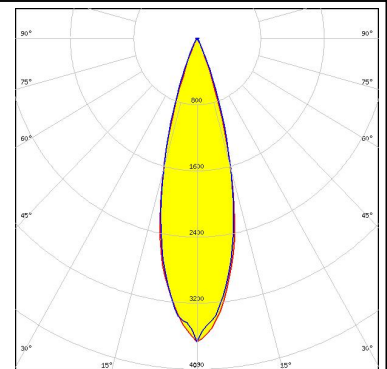

LED LUXEON Z ES
 FWHM / FWTM 28.0° / 45.0°
 Efficiency 94 %
 Peak intensity 4.1 cd/lm
 LEDs/each optic 1
 Light colour White
 Required components:

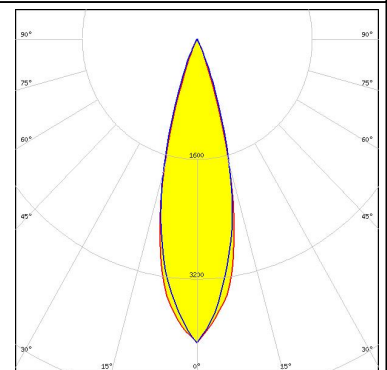

LED NVSxE21A
 FWHM / FWTM 28.0° / 47.0°
 Efficiency 94 %
 Peak intensity 3.7 cd/lm
 LEDs/each optic 1
 Light colour White
 Required components:

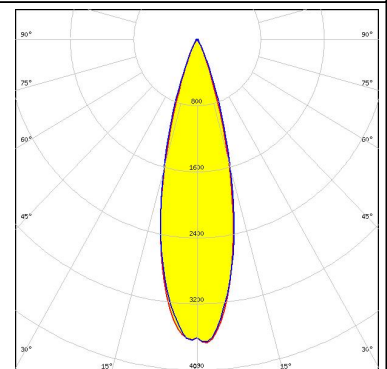

PHOTOMETRIC DATA (SIMULATED):

OSRAM Opto Semiconductors

LED OSCONIQ P 3030
 FWHM / FWTM 28.0° / 46.0°
 Efficiency 96 %
 Peak intensity 3.8 cd/lm
 LEDs/each optic 1
 Light colour White
 Required components:

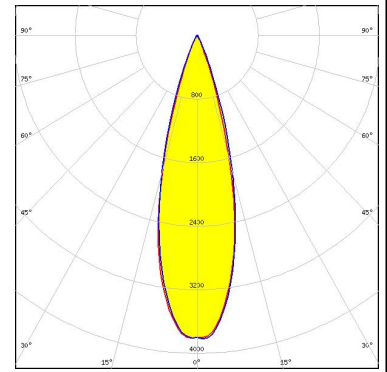

OSRAM Opto Semiconductors

LED OSLON Square CSSRM2/CSSRM3
 FWHM / FWTM 28.0° / 48.0°
 Efficiency 94 %
 Peak intensity 3.5 cd/lm
 LEDs/each optic 1
 Light colour White
 Required components:

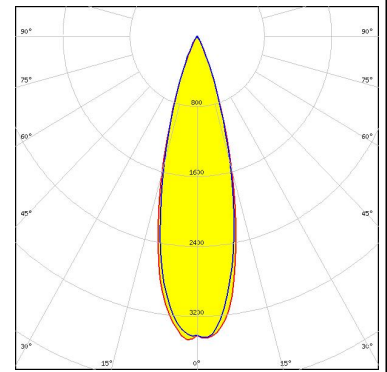

OSRAM Opto Semiconductors

LED OSLON Square EC
 FWHM / FWTM 29.0°
 Efficiency %
 Peak intensity 3.2 cd/lm
 LEDs/each optic 1
 Light colour White
 Required components:

OSRAM Opto Semiconductors

LED SFH 4170S
 FWHM / FWTM 28.0° / 44.0°
 Efficiency 88 %
 LEDs/each optic 1
 Light colour IR
 Required components:

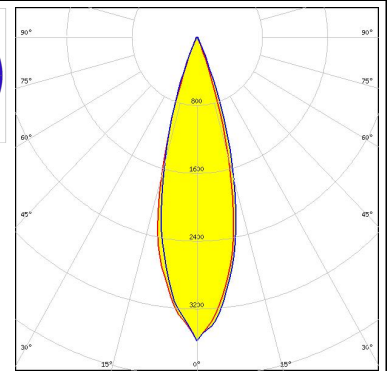
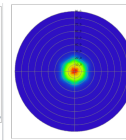
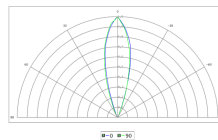

GENERAL INFORMATION:

NOTE: The typical beam angle will be changed by different color, chip size and chip position tolerance. The typical total beam angle is the full angle measured where the luminous intensity is half of the peak value.

MATERIALS:

As part of our continuous research and improvement processes, and to ensure the best possible quality and availability of our products, LEDiL reserves the right to change material grades without notice.

PRODUCT DATA USER AGREEMENT AND DISCLAIMER:

The measured data in the provided downloadable LEDiL Product Datasheets and Mechanical 2D-Drawings is rounded and provided as reference for planning. LEDiL Oy's optical specifications have been verified by conducting performance testing of the products in accordance with the company's quality system. The reported data are averaged results of multiple measurements with typical variation. LEDiL Oy reserves the right to without prior notification make changes and improvements to its products.

LEDiL Oy assumes neither warranty, nor guarantee nor any other liability of any kind for the contents and correctness of the provided data. The provided data has been generated with highest diligence but the provided data may in reality not represent the complete possible variation range of all intrinsic parameters. Therefore, in certain cases a deviation from the provided data could occur.

LEDiL Oy reserves the right to undertake technical changes of its products without further notification which could lead to changes in the provided data. LEDiL Oy assumes no liability of any kind for the possible deviation from any provided data or any other damage resulting from the usage of the provided data.

The user agrees to this disclaimer and user agreement with the download or usage of the provided files.

LEDiL Oy

Joensuunkatu 13
FI-24240 SALO
Finland

LEDiL Inc.

228 West Page Street
Suite D
Sycamore IL 60178
USA

Ledil Optics Technology (Shenzhen) Co., Ltd.

405 , Block B
Casic Motor Building
Shenzhen 518057
P.R.CHINA

Local sales and technical support

[www.ledil.com/
where_to_buy](http://www.ledil.com/where_to_buy)

Shipping locations

Salo, Finland
Hong Kong, China

Distribution Partners

[www.ledil.com/
where_to_buy](http://www.ledil.com/where_to_buy)

X-ON Electronics

Largest Supplier of Electrical and Electronic Components

Click to view similar products for [LED Lighting Lenses Assemblies](#) category:

Click to view products by [Ledil](#) manufacturer:

Other Similar products are found below :

[FCN12592_LE1-D-COP](#) [CA16129_OLGA-W](#) [CA16370_HB-SQ-W](#) [FN15972_RONDA-ZT45-C](#) [CS15759_HB-2X2MX-8-W](#)
[CA16435_LXP2-SS-WAS](#) [CN16210_GABRIELLA-MIDI-W](#) [CP17137_CARMEN-M2-C](#) [CA16015_STRADA-SQ-SCL](#) [CP17594_TINA-SC-](#)
[RS](#) [CS15767_HB-2X2MX-8-M](#) [CP10960_RGBX-SS](#) [CP12395_LXP3-W](#) [CP12939_LARISA-RS-CLIP16](#) [C14636_XTM-PF-ADAPTER](#)
[CA11819_STRADA-SQ-T-DW](#) [CA14508_G2-LXP2-D](#) [CA14601_VERONICA-SQ-MINI-RS](#) [FCP13895_SEANNA-A](#) [CP12943_LARISA-](#)
[O-CLIP16](#) [FP11124_LISA2-O-PIN](#) [CS14597_HB-IP-2X6-O](#) [CP14995_FLORENTINA-HLD-O](#) [CS15158_STRADA-IP-2X6-T4-B](#)
[CS16323_STRADELLA-IP-28-HB-M](#) [FN14976_STELLA-DWC2](#) [FN15264_STELLA-HB-WWW](#) [CA15584_ZORYA-MINI-TAPE](#)
[FA15229_ROSE-MRK-S](#) [FA15232_ROSE-MRK-M](#) [FA15233_ROSE-MRK-W](#) [FCN13552_CRYSTAL-RS](#) [FN15552_RONDA-W](#)
[FS15626_FLORENCE-3R-IP-Z90](#) [FS15786_FLORENCE-3R-IP-Z60](#) [FS15847_FLORENCE-3R-IP-O](#) [CA14505_G2-LXP2-RS2-P](#)
[FCN12775_IRIS-O](#) [CP15304_LARISA-RS-PIN](#) [FN15679_RONDA-S](#) [CA15519_VERONICA-SQ-MINI-D](#) [FP14414_LISA2-O-PIN](#)
[LL01CR-DF60L06-M2](#) [FN15993_RONDA-O](#) [FN15977_RONDA-WAS2](#) [CA14366_FLARE-MAXI-TAPE](#) [CA14442_VERONICA-SQ-W](#)
[CA14509_G2-LXP2-M-P](#) [CA15231_VERONICA-SQ-MINI-W](#) [FP11002_LISA2-W-PIN](#)