

## LAURA-D-PIN

~15° diffused spot beam optimized for CREE XP-E. Assembly with white holder, installation tape and location pins.

### TECHNICAL SPECIFICATIONS:

Dimensions	21.6 x 21.6 mm
Height	13.1 mm
Fastening	tape, pin
ROHS compliant	yes ⓘ



### MATERIAL SPECIFICATIONS:

Component	Type	Material	Colour	Finish
LAURA-D	Single lens	PMMA	clear	
LAURA-PIN-XP-HLD-WHT	Holder	PC	white	
ROSE-TAPE	Tape	Acrylic foam	black	

### ORDERING INFORMATION:

Component	Type	Qty in box	MOQ	MPQ	Box weight (kg)
CA11960_LAURA-D-PIN	Single lens	1440		180	7.5
» Box size:					

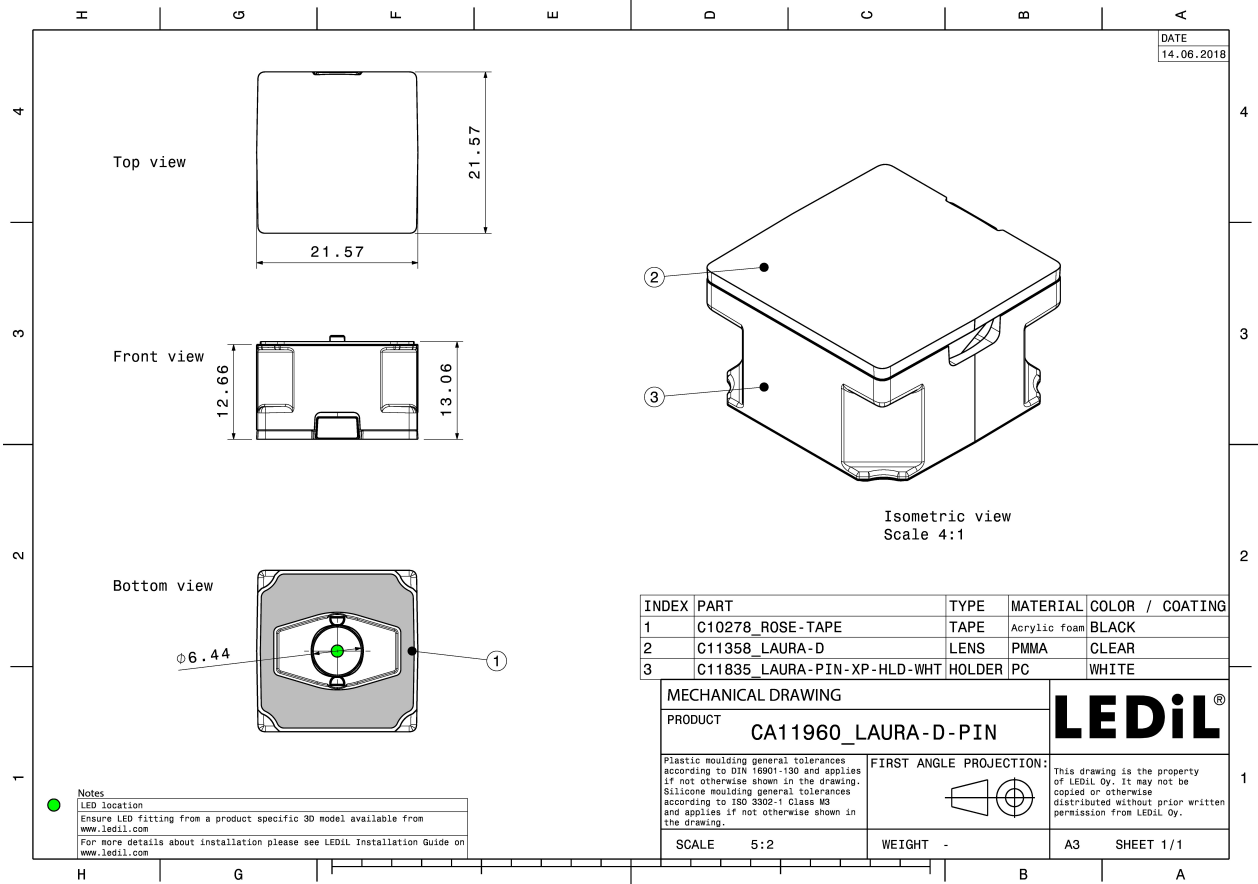

See also our general installation guide: [www.ledil.com/installation\\_guide](http://www.ledil.com/installation_guide)

#### PHOTOMETRIC DATA (MEASURED):

##### CREE → LED

LED XP-E  
FWHM / FWTM 13.0° / 31.0°  
Efficiency 93 %  
Peak intensity 9.3 cd/m  
LEDs/each optic 1  
Light colour White  
Required components:

##### CREE → LED

LED XP-E-HEW  
FWHM / FWTM 15.0° / 33.0°  
Efficiency 86 %  
Peak intensity 6.2 cd/m  
LEDs/each optic 1  
Light colour White  
Required components:

##### CREE → LED

LED XP-E2  
FWHM / FWTM 15.0° / 36.0°  
Efficiency 88 %  
Peak intensity 6.4 cd/m  
LEDs/each optic 1  
Light colour White  
Required components:

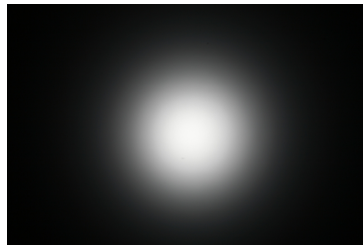

##### CREE → LED

LED XP-G  
FWHM / FWTM 16.0°  
Efficiency 94 %  
LEDs/each optic 1  
Light colour White  
Required components:

#### PHOTOMETRIC DATA (MEASURED):

#### LUMILEDS

LED LUXEON Rebel  
 FWHM / FWTM 15.0° / 37.0°  
 Efficiency 90 %  
 Peak intensity 5 cd/lm  
 LEDs/each optic 1  
 Light colour White  
 Required components:

#### LUMILEDS

LED LUXEON T  
 FWHM / FWTM 18.0° / 40.0°  
 Efficiency 89 %  
 Peak intensity 4.5 cd/lm  
 LEDs/each optic 1  
 Light colour White  
 Required components:

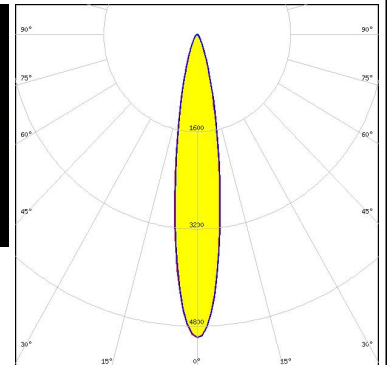

#### LUMILEDS

LED LUXEON Z ES  
 FWHM / FWTM 15.0° / 34.0°  
 Efficiency 90 %  
 Peak intensity 7.1 cd/lm  
 LEDs/each optic 1  
 Light colour White  
 Required components:



#### NICHIA

LED NCSxx19B  
 FWHM / FWTM 19.0° / 41.0°  
 Efficiency 85 %  
 Peak intensity 5 cd/lm  
 LEDs/each optic 1  
 Light colour White  
 Required components:

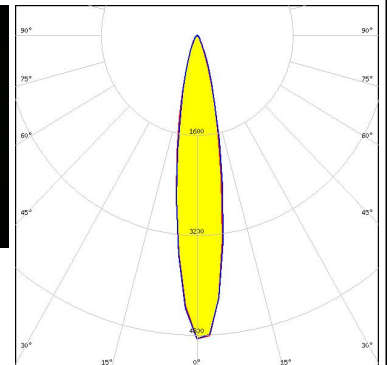

#### PHOTOMETRIC DATA (MEASURED):

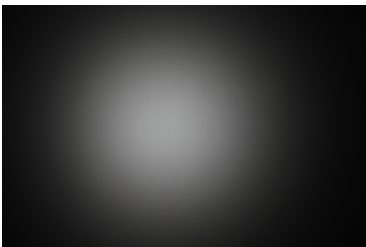
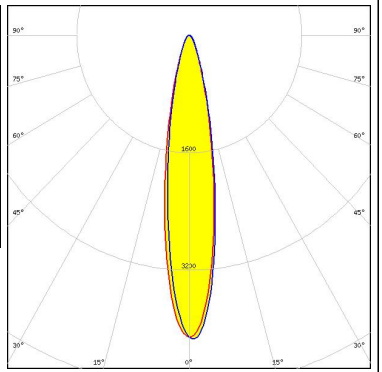
<p><b>NICHIA</b></p> <p>LED NF2x757D            FWHM / FWTM 19.0° / 43.0°            Efficiency 84 %            Peak intensity 4.2 cd/lm            LEDs/each optic 1            Light colour White            Required components:</p>		
<p><b>OSRAM</b>  <small>Opto Semiconductors</small></p> <p>LED OSLON Square EC            FWHM / FWTM 16.0° / 34.0°            Efficiency 81 %            Peak intensity 6.7 cd/lm            LEDs/each optic 1            Light colour White            Required components:</p>		
<p><b>OSRAM</b>  <small>Opto Semiconductors</small></p> <p>LED OSLON SSL 150            FWHM / FWTM 12.0° / 28.0°            Efficiency 83 %            Peak intensity 8.9 cd/lm            LEDs/each optic 1            Light colour White            Required components:</p>		
<p><b>OSRAM</b>  <small>Opto Semiconductors</small></p> <p>LED OSLON SSL 80            FWHM / FWTM 14.0° / 31.0°            Efficiency 83 %            Peak intensity 7.3 cd/lm            LEDs/each optic 1            Light colour White            Required components:</p>		

## PHOTOMETRIC DATA (MEASURED):

**OSRAM**  
Opto Semiconductors

LED SFH 4725S  
FWHM / FWTM 18.0° / 42.0°  
Efficiency %  
LEDs/each optic 1  
Light colour White  
Required components:



SEOUL SEMICONDUCTOR

LED Z5  
FWHM / FWTM 14.0°  
Efficiency %  
LEDs/each optic 1  
Light colour White  
Required components:

#### PHOTOMETRIC DATA (SIMULATED):

##### CREE LED

LED XD16  
 FWHM / FWTM 12.0° / 23.0°  
 Efficiency 90 %  
 Peak intensity 16.1 cd/lm  
 LEDs/each optic 1  
 Light colour White  
 Required components:

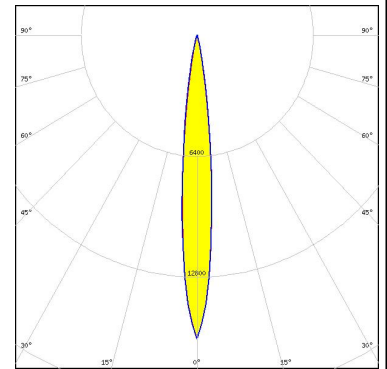

##### CREE LED

LED XP-G3  
 FWHM / FWTM 17.0° / 32.0°  
 Efficiency 93 %  
 Peak intensity 8.2 cd/lm  
 LEDs/each optic 1  
 Light colour White  
 Required components:

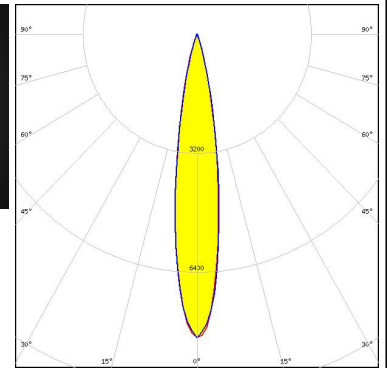
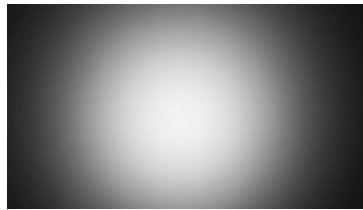

##### LUMILEDS

LED LUXEON H50-2  
 FWHM / FWTM 13.0° / 28.0°  
 Efficiency 90 %  
 Peak intensity 9.5 cd/lm  
 LEDs/each optic 1  
 Light colour White  
 Required components:

##### LUMILEDS

LED LUXEON IR Domed 150  
 FWHM / FWTM 9.0° / 18.0°  
 Efficiency 0 %  
 LEDs/each optic 1  
 Light colour White  
 Required components:

#### PHOTOMETRIC DATA (SIMULATED):

#### LUMILEDS

LED LUXEON IR Domed 60  
 FWHM / FWTM 12.0° / 25.0°  
 Efficiency 94 %  
 LEDs/each optic 1  
 Light colour White  
 Required components:

#### LUMILEDS

LED LUXEON IR Domed 90  
 FWHM / FWTM 12.0° / 24.0°  
 Efficiency 94 %  
 LEDs/each optic 1  
 Light colour White  
 Required components:

#### NICHIA

LED NV4WB35AM  
 FWHM / FWTM 16.0° / 32.0°  
 Efficiency 96 %  
 Peak intensity 8.5 cd/lm  
 LEDs/each optic 1  
 Light colour White  
 Required components:

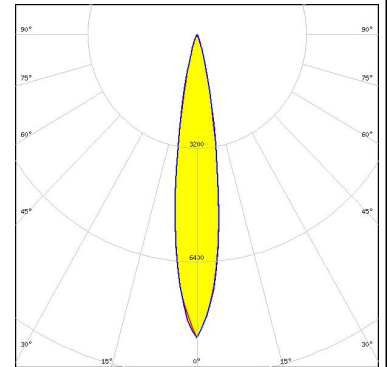

#### OSRAM

Opto Semiconductors

LED KW CULPM1.TG  
 FWHM / FWTM 10.0° / 20.0°  
 Efficiency 96 %  
 Peak intensity 21.9 cd/lm  
 LEDs/each optic 1  
 Light colour White  
 Required components:

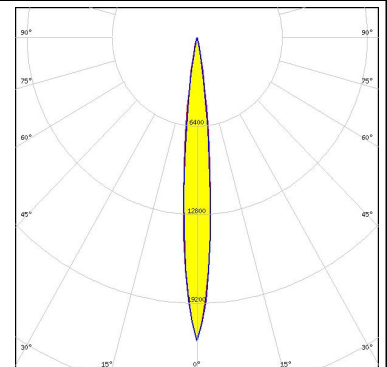



#### PHOTOMETRIC DATA (SIMULATED):

##### OSRAM

Opto Semiconductors

LED OSLON Signal  
 FWHM / FWTM 10.0° / 20.0°  
 Efficiency 96 %  
 Peak intensity 23.8 cd/lm  
 LEDs/each optic 1  
 Light colour Red  
 Required components:

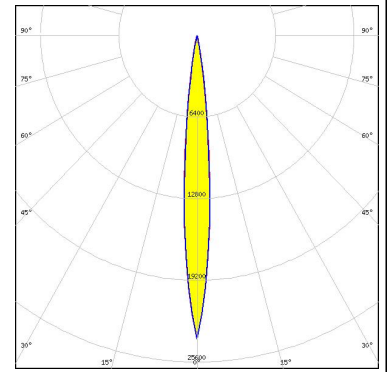

##### OSRAM

Opto Semiconductors

LED OSLON Square CSSRM2/CSSRM3  
 FWHM / FWTM 12.0° / 24.0°  
 Efficiency 96 %  
 Peak intensity 15.9 cd/lm  
 LEDs/each optic 1  
 Light colour White  
 Required components:

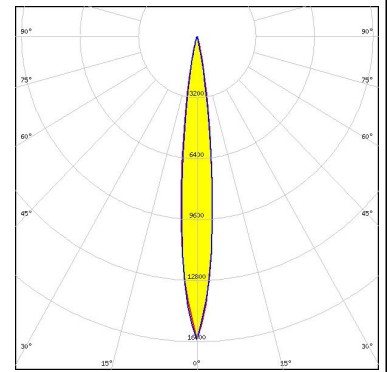

##### OSRAM

Opto Semiconductors

LED SFH 4715S  
 FWHM / FWTM 13.0°  
 Efficiency %  
 LEDs/each optic 1  
 Light colour White  
 Required components:

### GENERAL INFORMATION:

NOTE: The typical beam angle will be changed by different color, chip size and chip position tolerance. The typical total beam angle is the full angle measured where the luminous intensity is half of the peak value.

### MATERIALS:

As part of our continuous research and improvement processes, and to ensure the best possible quality and availability of our products, LEDiL reserves the right to change material grades without notice.

### PRODUCT DATA USER AGREEMENT AND DISCLAIMER:

The measured data in the provided downloadable LEDiL Product Datasheets and Mechanical 2D-Drawings is rounded and provided as reference for planning. LEDiL Oy's optical specifications have been verified by conducting performance testing of the products in accordance with the company's quality system. The reported data are averaged results of multiple measurements with typical variation. LEDiL Oy reserves the right to without prior notification make changes and improvements to its products.

LEDiL Oy assumes neither warranty, nor guarantee nor any other liability of any kind for the contents and correctness of the provided data. The provided data has been generated with highest diligence but the provided data may in reality not represent the complete possible variation range of all intrinsic parameters. Therefore, in certain cases a deviation from the provided data could occur.

LEDiL Oy reserves the right to undertake technical changes of its products without further notification which could lead to changes in the provided data. LEDiL Oy assumes no liability of any kind for the possible deviation from any provided data or any other damage resulting from the usage of the provided data.

The user agrees to this disclaimer and user agreement with the download or usage of the provided files.

#### LEDiL Oy

Joensuunkatu 13  
FI-24240 SALO  
Finland

#### LEDiL Inc.

228 West Page Street  
Suite D  
Sycamore IL 60178  
USA

#### Ledil Optics Technology (Shenzhen) Co., Ltd.

# 405 , Block B  
Casic Motor Building  
Shenzhen 518057  
P.R.CHINA

#### Local sales and technical support

[www.ledil.com/  
where\\_to\\_buy](http://www.ledil.com/where_to_buy)

#### Shipping locations

Salo, Finland  
Hong Kong, China

#### Distribution Partners

[www.ledil.com/  
where\\_to\\_buy](http://www.ledil.com/where_to_buy)

## X-ON Electronics

Largest Supplier of Electrical and Electronic Components

*Click to view similar products for [LED Lighting Lenses Assemblies](#) category:*

*Click to view products by [Ledil](#) manufacturer:*

Other Similar products are found below :

[FCN12592\\_LE1-D-COP](#) [CA16129\\_OLGA-W](#) [CA16370\\_HB-SQ-W](#) [FN15972\\_RONDA-ZT45-C](#) [CS15759\\_HB-2X2MX-8-W](#)  
[CA16435\\_LXP2-SS-WAS](#) [CN16210\\_GABRIELLA-MIDI-W](#) [CP17137\\_CARMEN-M2-C](#) [CA16015\\_STRADA-SQ-SCL](#) [CP17594\\_TINA-SC-](#)  
[RS](#) [CS15767\\_HB-2X2MX-8-M](#) [CP10960\\_RGBX-SS](#) [CP12395\\_LXP3-W](#) [CP12939\\_LARISA-RS-CLIP16](#) [C14636\\_XTM-PF-ADAPTER](#)  
[CA11819\\_STRADA-SQ-T-DW](#) [CA14506\\_G2-LXP2-RS2](#) [CA14508\\_G2-LXP2-D](#) [CA14601\\_VERONICA-SQ-MINI-RS](#)  
[FCP13895\\_SEANNA-A](#) [FP11124\\_LISA2-O-PIN](#) [CS14597\\_HB-IP-2X6-O](#) [CP14995\\_FLORENTINA-HLD-O](#) [CS15158\\_STRADA-IP-2X6-](#)  
[T4-B](#) [CS16323\\_STRADELLA-IP-28-HB-M](#) [FN14976\\_STELLA-DWC2](#) [FN15264\\_STELLA-HB-WWW](#) [CA15584\\_ZORYA-MINI-TAPE](#)  
[FA15229\\_ROSE-MRK-S](#) [FA15232\\_ROSE-MRK-M](#) [FA15233\\_ROSE-MRK-W](#) [FCN13552\\_CRYSTAL-RS](#) [FN15552\\_RONDA-W](#)  
[FS15626\\_FLORENCE-3R-IP-Z90](#) [FS15786\\_FLORENCE-3R-IP-Z60](#) [FS15847\\_FLORENCE-3R-IP-O](#) [CA14505\\_G2-LXP2-RS2-P](#)  
[FCN12775\\_IRIS-O](#) [FCA15007\\_G2-ROSE-UV-SS](#) [CP15304\\_LARISA-RS-PIN](#) [FN15679\\_RONDA-S](#) [CA15519\\_VERONICA-SQ-MINI-D](#)  
[FP14414\\_LISA2-O-PIN](#) [LL01CR-DF60L06-M2](#) [FN15993\\_RONDA-O](#) [FN15977\\_RONDA-WAS2](#) [CA14366\\_FLARE-MAXI-TAPE](#)  
[CA14442\\_VERONICA-SQ-W](#) [CA14509\\_G2-LXP2-M-P](#) [CA15231\\_VERONICA-SQ-MINI-W](#)