

EMILY-D

~11° diffused spot beam. 14.74 mm high lens.

TECHNICAL SPECIFICATIONS:

Dimensions	Ø 26.0 mm
Height	14.7 mm
Fastening	tape, pin
ROHS compliant	yes ⓘ

MATERIAL SPECIFICATIONS:

Component	Type	Material	Colour	Finish
EMILY-D	Single lens	PMMA	clear	
SPUTNIK-TAPE	Tape	Acrylic foam	black	

ORDERING INFORMATION:

Component		Qty in box	MOQ	MPQ	Box weight (kg)
CA12062_EMILY-D	Single lens	1690	260	130	10.5
» Box size: 480 x 280 x 300 mm					



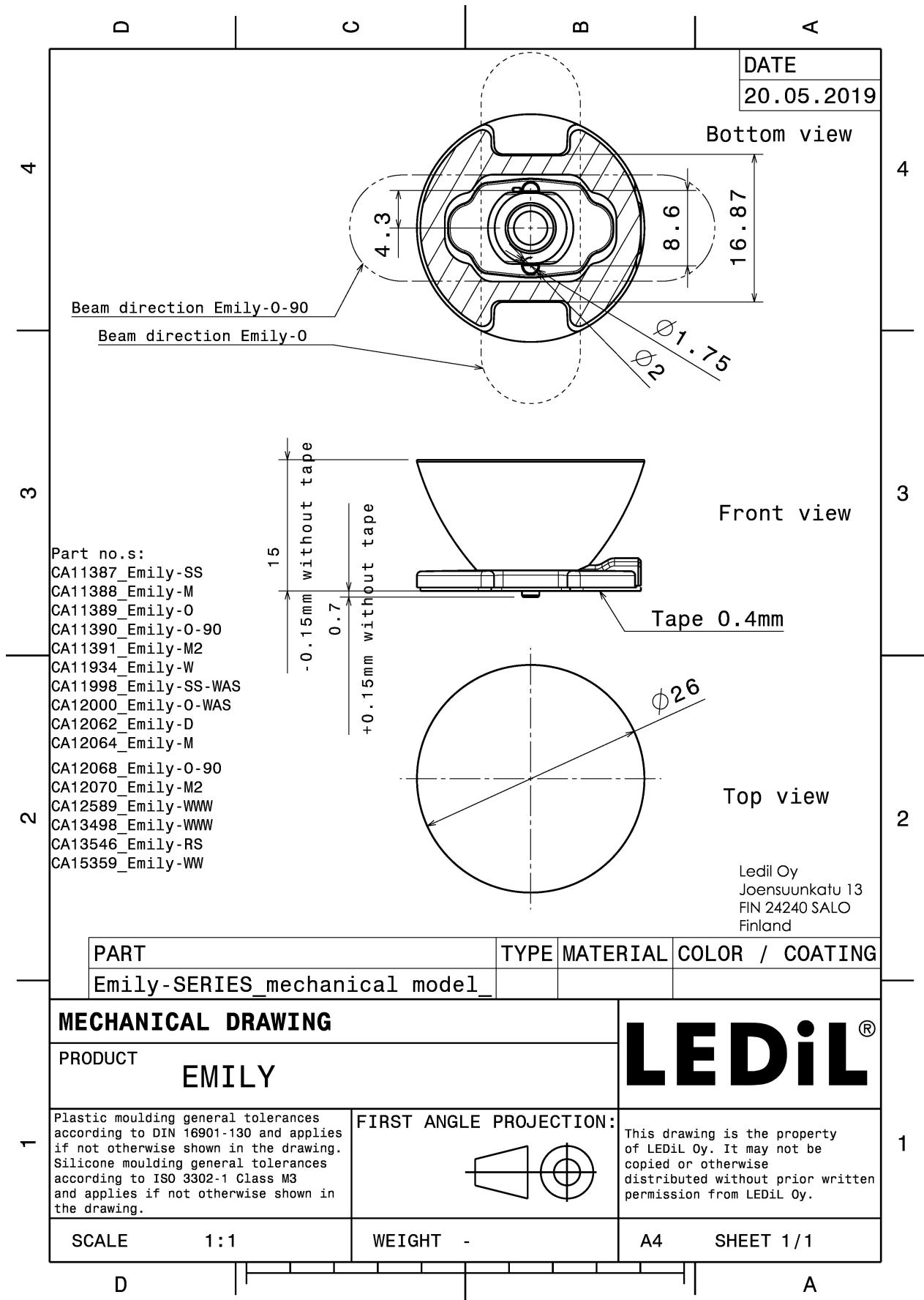

See also our general installation guide: www.ledil.com/installation_guide

PHOTOMETRIC DATA (MEASURED):

CREE → LED

LED XB-H
 FWHM / FWTM 10.0° / 22.0°
 Efficiency 89 %
 Peak intensity 17.5 cd/lm
 LEDs/each optic 1
 Light colour White
 Required components:

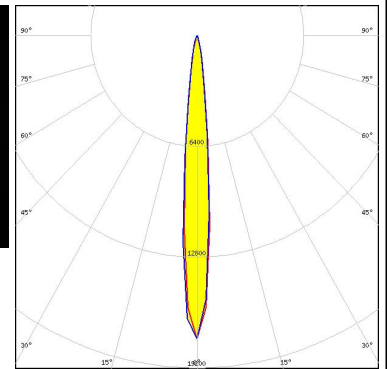

CREE → LED

LED XD16
 FWHM / FWTM 8.0° / 18.0°
 Efficiency 92 %
 Peak intensity 18.4 cd/lm
 LEDs/each optic 1
 Light colour White
 Required components:

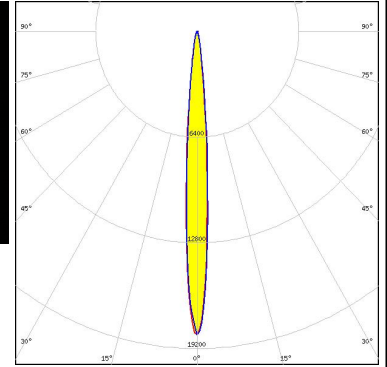

CREE → LED

LED XHP35 HI
 FWHM / FWTM 11.0° / 22.0°
 Efficiency 92 %
 Peak intensity 14.5 cd/lm
 LEDs/each optic 1
 Light colour White
 Required components:

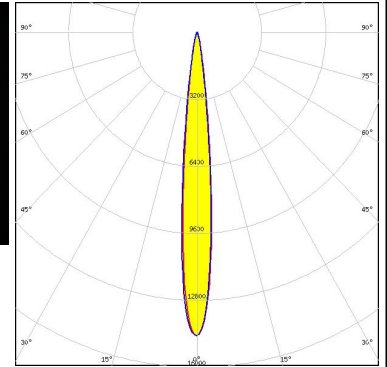

CREE → LED

LED XM-L
 FWHM / FWTM 14.0° / 27.0°
 Efficiency 90 %
 Peak intensity 10.1 cd/lm
 LEDs/each optic 1
 Light colour White
 Required components:

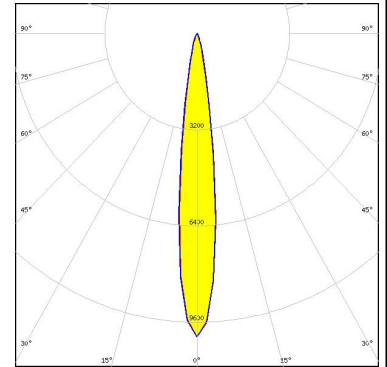

PHOTOMETRIC DATA (MEASURED):

CREE LED

LED XM-L2
 FWHM / FWTM 14.0° / 27.0°
 Efficiency 90 %
 Peak intensity 10.2 cd/lm
 LEDs/each optic 1
 Light colour White
 Required components:

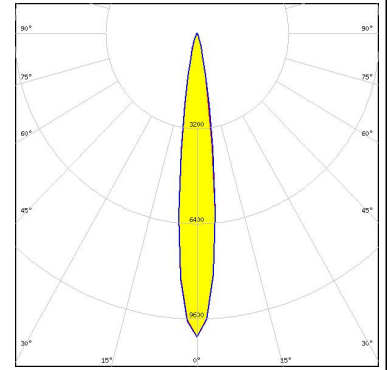

CREE LED

LED XP-E2
 FWHM / FWTM 8.0° / 18.0°
 Efficiency 87 %
 Peak intensity 27.3 cd/lm
 LEDs/each optic 1
 Light colour White
 Required components:

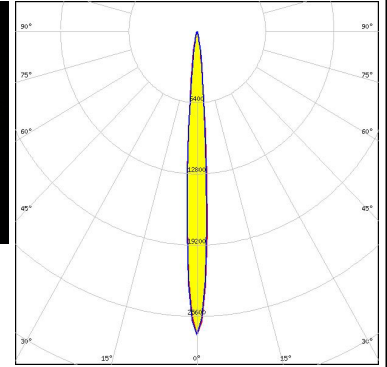
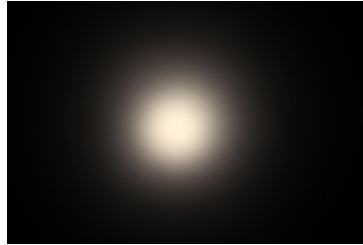

CREE LED

LED XP-G2
 FWHM / FWTM 10.0° / 20.0°
 Efficiency 90 %
 Peak intensity 20.8 cd/lm
 LEDs/each optic 1
 Light colour White
 Required components:

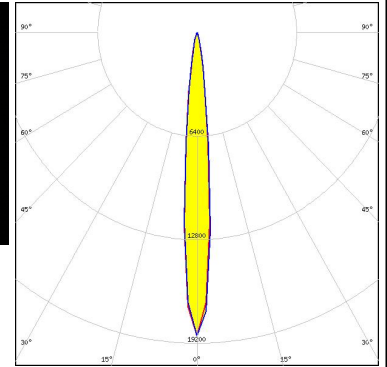

CREE LED

LED XP-G3
 FWHM / FWTM 11.0° / 24.0°
 Efficiency 94 %
 Peak intensity 13 cd/lm
 LEDs/each optic 1
 Light colour White
 Required components:

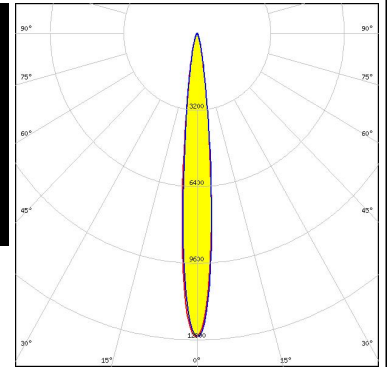

PHOTOMETRIC DATA (MEASURED):

CREE LED

LED XP-L HD
 FWHM / FWTM 13.0° / 26.0°
 Efficiency 90 %
 Peak intensity 10.2 cd/lm
 LEDs/each optic 1
 Light colour White
 Required components:

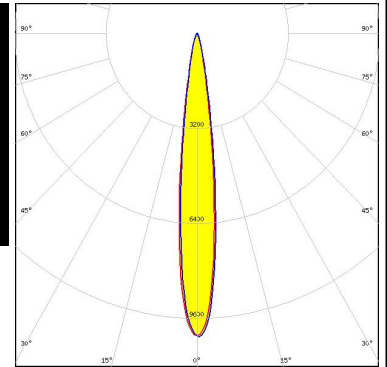
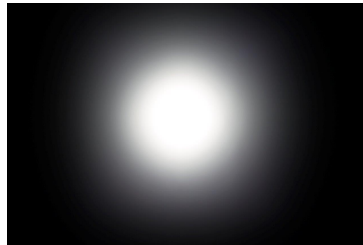

CREE LED

LED XP-L HI
 FWHM / FWTM 9.0° / 19.0°
 Efficiency 87 %
 Peak intensity 20 cd/lm
 LEDs/each optic 1
 Light colour White
 Required components:

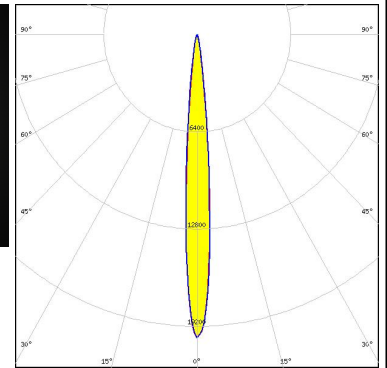





CREE LED

LED XT-E
 FWHM / FWTM 9.0°
 Efficiency %
 Peak intensity 14 cd/lm
 LEDs/each optic 1
 Light colour White
 Required components:

LUMILEDS

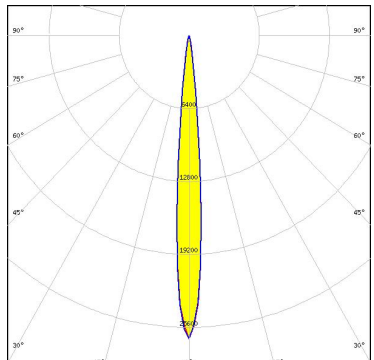
LED LUXEON A
 FWHM / FWTM 11.0°
 Efficiency 91 %
 LEDs/each optic 1
 Light colour White
 Required components:

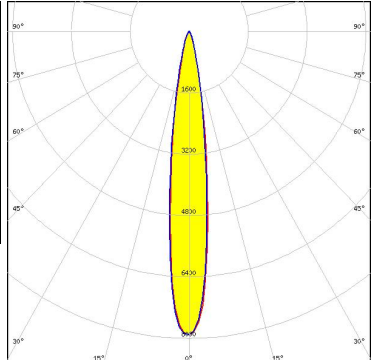
PHOTOMETRIC DATA (MEASURED):

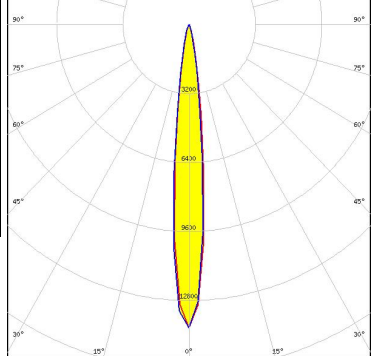
<p>LUMILEDS</p> <p>LED: LUXEON Rebel ES FWHM / FWTM: 10.0° Efficiency: 91 % LEDs/each optic: 1 Light colour: White Required components:</p>		
<p>NICHIA</p> <p>LED: NS9x383 FWHM / FWTM: 14.0° / 30.0° Efficiency: 90 % Peak intensity: 7.9 cd/lm LEDs/each optic: 1 Light colour: White Required components:</p>		
<p>OSRAM Opto Semiconductors</p> <p>LED: OSLOM Square EC FWHM / FWTM: 9.0° / 20.0° Efficiency: 86 % Peak intensity: 20.1 cd/lm LEDs/each optic: 1 Light colour: White Required components:</p>		
<p>SAMSUNG</p> <p>LED: LH351B FWHM / FWTM: 12.0° / 25.0° Efficiency: 88 % Peak intensity: 14 cd/lm LEDs/each optic: 1 Light colour: White Required components:</p>		

PHOTOMETRIC DATA (MEASURED):

SAMSUNG

LED LH351Z
 FWHM / FWTM 10.0° / 21.0°
 Efficiency 88 %
 Peak intensity 20 cd/lm
 LEDs/each optic 1
 Light colour White
 Required components:

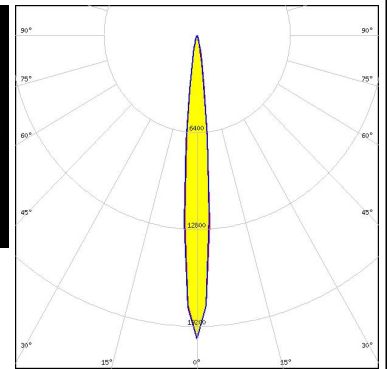

SEOUL SEMICONDUCTOR

LED Z5M1/Z5M2
 FWHM / FWTM 10.0° / 20.0°
 Efficiency 94 %
 Peak intensity 18.2 cd/lm
 LEDs/each optic 1
 Light colour White
 Required components:

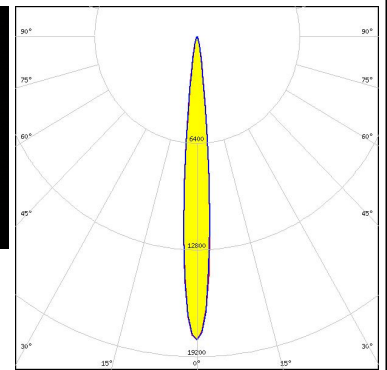

SEOUL SEMICONDUCTOR

LED Z8Y22P
 FWHM / FWTM 11.0° / 24.0°
 Efficiency 93 %
 Peak intensity 11.3 cd/lm
 LEDs/each optic 1
 Light colour White
 Required components:

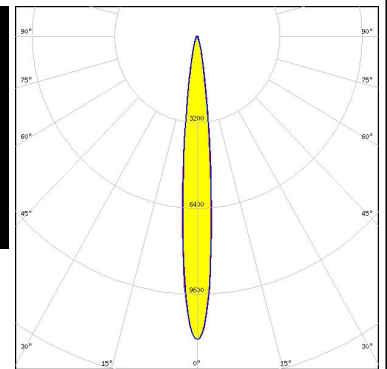

PHOTOMETRIC DATA (SIMULATED):

<p>CREE LED</p> <p>LED: XM-L HVW FWHM / FWTM: 14.0° / 27.0° Efficiency: % LEDs/each optic: 1 Light colour: White Required components:</p>	
<p>CREE LED</p> <p>LED: XP-G2 HE FWHM / FWTM: 12.0° / 24.0° Efficiency: 95 % Peak intensity: 15.2 cd/lm LEDs/each optic: 1 Light colour: White Required components:</p>	
<p>LUMILEDS</p> <p>LED: LUXEON MZ FWHM / FWTM: 14.0° / 28.0° Efficiency: 95 % Peak intensity: 10.7 cd/lm LEDs/each optic: 1 Light colour: White Required components:</p>	
<p>NICHIA</p> <p>LED: NCSxE17A FWHM / FWTM: 10.0° / 20.0° Efficiency: 93 % Peak intensity: 21.8 cd/lm LEDs/each optic: 1 Light colour: White Required components:</p>	

PHOTOMETRIC DATA (SIMULATED):

<p>NICHIA</p> <p>LED NVSxE21A FWHM / FWTM 10.0° / 22.0° Efficiency 94 % Peak intensity 18.6 cd/lm LEDs/each optic 1 Light colour White Required components:</p>	
<p>OSRAM Opto Semiconductors</p> <p>LED OSCONIQ C 2424 FWHM / FWTM 10.0° / 18.0° Efficiency 96 % Peak intensity 24.8 cd/lm LEDs/each optic 1 Light colour White Required components:</p>	
<p>OSRAM Opto Semiconductors</p> <p>LED OSOLON Square CSSRM2/CSSRM3 FWHM / FWTM 9.9° / 20.0° Efficiency 94 % Peak intensity 22.5 cd/lm LEDs/each optic 1 Light colour White Required components:</p>	
<p>OSRAM Opto Semiconductors</p> <p>LED SFH 4725AS FWHM / FWTM 11.0° / 22.0° Efficiency 95 % LEDs/each optic 1 Light colour IR Required components:</p>	

GENERAL INFORMATION:

NOTE: The typical beam angle will be changed by different color, chip size and chip position tolerance. The typical total beam angle is the full angle measured where the luminous intensity is half of the peak value.

MATERIALS:

As part of our continuous research and improvement processes, and to ensure the best possible quality and availability of our products, LEDiL reserves the right to change material grades without notice.

PRODUCT DATA USER AGREEMENT AND DISCLAIMER:

The measured data in the provided downloadable LEDiL Product Datasheets and Mechanical 2D-Drawings is rounded and provided as reference for planning. LEDiL Oy's optical specifications have been verified by conducting performance testing of the products in accordance with the company's quality system. The reported data are averaged results of multiple measurements with typical variation. LEDiL Oy reserves the right to without prior notification make changes and improvements to its products.

LEDiL Oy assumes neither warranty, nor guarantee nor any other liability of any kind for the contents and correctness of the provided data. The provided data has been generated with highest diligence but the provided data may in reality not represent the complete possible variation range of all intrinsic parameters. Therefore, in certain cases a deviation from the provided data could occur.

LEDiL Oy reserves the right to undertake technical changes of its products without further notification which could lead to changes in the provided data. LEDiL Oy assumes no liability of any kind for the possible deviation from any provided data or any other damage resulting from the usage of the provided data.

The user agrees to this disclaimer and user agreement with the download or usage of the provided files.

LEDiL Oy

Joensuunkatu 13
FI-24240 SALO
Finland

LEDiL Inc.

228 West Page Street
Suite D
Sycamore IL 60178
USA

Ledil Optics Technology (Shenzhen) Co., Ltd.

405 , Block B
Casic Motor Building
Shenzhen 518057
P.R.CHINA

Local sales and technical support

[www.ledil.com/
where_to_buy](http://www.ledil.com/where_to_buy)

Shipping locations

Salo, Finland
Hong Kong, China

Distribution Partners

[www.ledil.com/
where_to_buy](http://www.ledil.com/where_to_buy)

X-ON Electronics

Largest Supplier of Electrical and Electronic Components

Click to view similar products for [LED Lighting Lenses Assemblies](#) category:

Click to view products by [Ledil](#) manufacturer:

Other Similar products are found below :

[FCN12592_LE1-D-COP](#) [CA16129_OLGA-W](#) [CA16370_HB-SQ-W](#) [FN15972_RONDA-ZT45-C](#) [CS15759_HB-2X2MX-8-W](#)
[CA16435_LXP2-SS-WAS](#) [CN16210_GABRIELLA-MIDI-W](#) [CP17137_CARMEN-M2-C](#) [CA16015_STRADA-SQ-SCL](#) [CP17594_TINA-SC-](#)
[RS](#) [CS15767_HB-2X2MX-8-M](#) [CP10960_RGBX-SS](#) [CP12395_LXP3-W](#) [CP12939_LARISA-RS-CLIP16](#) [C14636_XTM-PF-ADAPTER](#)
[CA11819_STRADA-SQ-T-DW](#) [CA14508_G2-LXP2-D](#) [CA14601_VERONICA-SQ-MINI-RS](#) [FCP13895_SEANNA-A](#) [CP12943_LARISA-](#)
[O-CLIP16](#) [FP11124_LISA2-O-PIN](#) [CS14597_HB-IP-2X6-O](#) [CP14995_FLORENTINA-HLD-O](#) [CS15158_STRADA-IP-2X6-T4-B](#)
[CS16323_STRADELLA-IP-28-HB-M](#) [FN14976_STELLA-DWC2](#) [FN15264_STELLA-HB-WWW](#) [CA15584_ZORYA-MINI-TAPE](#)
[FA15229_ROSE-MRK-S](#) [FA15232_ROSE-MRK-M](#) [FA15233_ROSE-MRK-W](#) [FCN13552_CRYSTAL-RS](#) [FN15552_RONDA-W](#)
[FS15626_FLORENCE-3R-IP-Z90](#) [FS15786_FLORENCE-3R-IP-Z60](#) [FS15847_FLORENCE-3R-IP-O](#) [CA14505_G2-LXP2-RS2-P](#)
[FCN12775_IRIS-O](#) [CP15304_LARISA-RS-PIN](#) [FN15679_RONDA-S](#) [CA15519_VERONICA-SQ-MINI-D](#) [FP14414_LISA2-O-PIN](#)
[LL01CR-DF60L06-M2](#) [FN15993_RONDA-O](#) [FN15977_RONDA-WAS2](#) [CA14366_FLARE-MAXI-TAPE](#) [CA14442_VERONICA-SQ-W](#)
[CA14509_G2-LXP2-M-P](#) [CA15231_VERONICA-SQ-MINI-W](#) [FP11002_LISA2-W-PIN](#)