

## TINA2-M

~30° medium beam. Assembly with holder, installation tape and location pins.

### TECHNICAL SPECIFICATIONS:

Dimensions	Ø 16.0 mm
Height	9.5 mm
Fastening	tape, pin
ROHS compliant	yes ⓘ

### MATERIAL SPECIFICATIONS:

Component	Type	Material	Colour	Finish
TINA2-XP-M	Single lens	PMMA	clear	
TINA2-HLD-BLK	Holder	PC	black	
TINA-TAPE3	Tape	Acrylic foam	black	

### ORDERING INFORMATION:

Component		Qty in box	MOQ	MPQ	Box weight (kg)
CA12377_TINA2-M	Single lens	4140	230	230	8.3
» Box size: 451 x 241 x 298 mm					



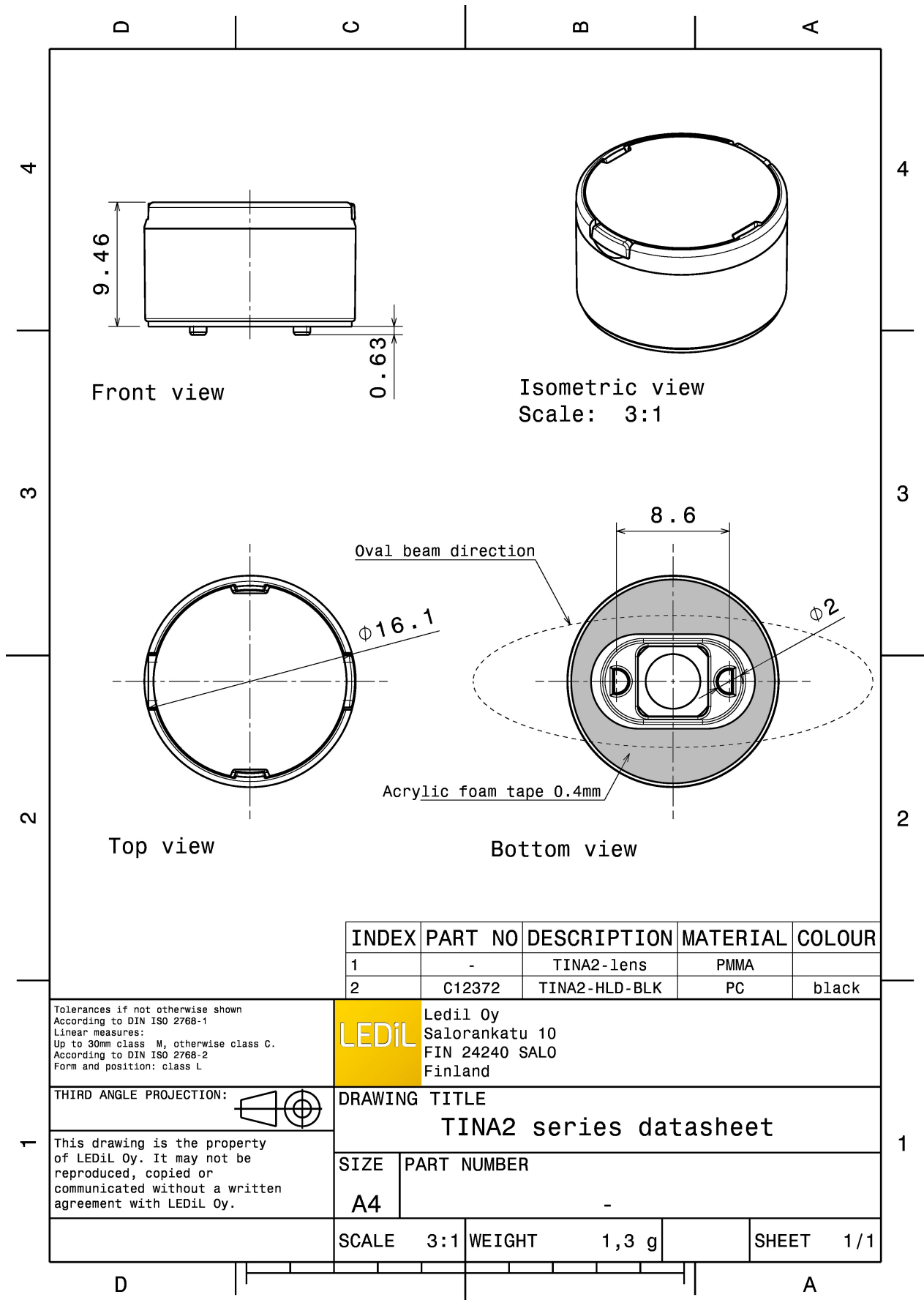

See also our general installation guide: [www.ledil.com/installation\\_guide](http://www.ledil.com/installation_guide)

### PHOTOMETRIC DATA (MEASURED):

#### CREE LED

LED XB-H  
 FWHM / FWTM 31.0° / 54.0°  
 Efficiency 85 %  
 Peak intensity 2.7 cd/lm  
 LEDs/each optic 1  
 Light colour White  
 Required components:

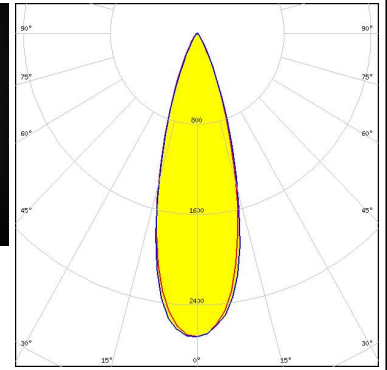

#### CREE LED

LED XD16  
 FWHM / FWTM 30.0° / 52.0°  
 Efficiency 83 %  
 Peak intensity 2.8 cd/lm  
 LEDs/each optic 1  
 Light colour White  
 Required components:

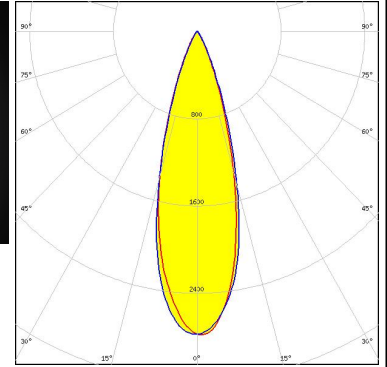

#### CREE LED

LED XQ-E HD  
 FWHM / FWTM 29.0° / 51.0°  
 Efficiency 84 %  
 Peak intensity 3.2 cd/lm  
 LEDs/each optic 1  
 Light colour White  
 Required components:

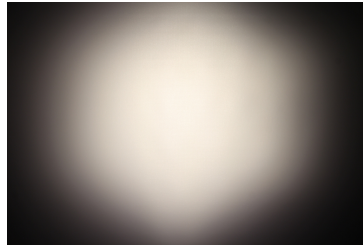

#### LUMILEDS

LED LUXEON CZ  
 FWHM / FWTM 28.0° / 47.0°  
 Efficiency 89 %  
 Peak intensity 3.4 cd/lm  
 LEDs/each optic 1  
 Light colour White  
 Required components:

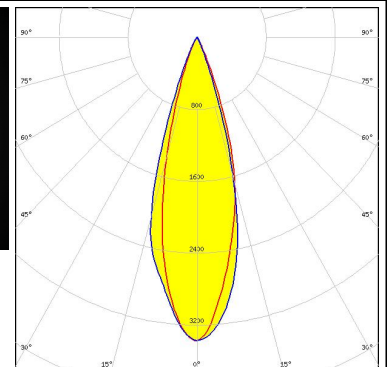
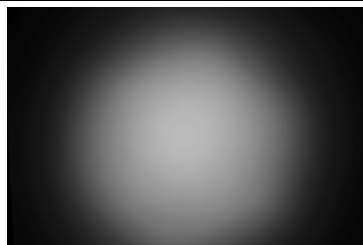

### PHOTOMETRIC DATA (MEASURED):

#### LUMILEDS

LED LUXEON TX  
 FWHM / FWTM 30.0° / 53.0°  
 Efficiency 86 %  
 Peak intensity 2.8 cd/lm  
 LEDs/each optic 1  
 Light colour White  
 Required components:

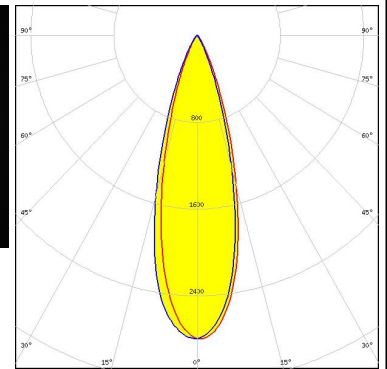
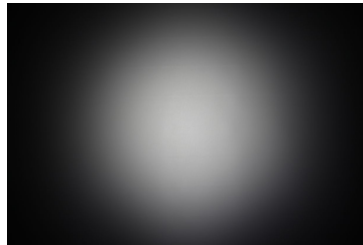

#### LUMILEDS

LED LUXEON Z ES  
 FWHM / FWTM 31.0° / 50.0°  
 Efficiency 88 %  
 Peak intensity 3.2 cd/lm  
 LEDs/each optic 1  
 Light colour White  
 Required components:

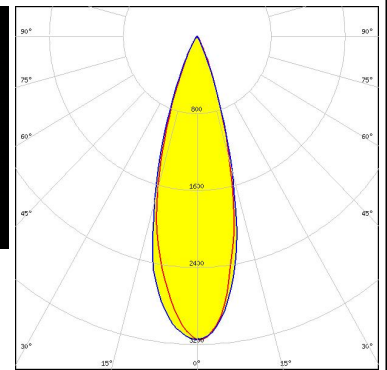
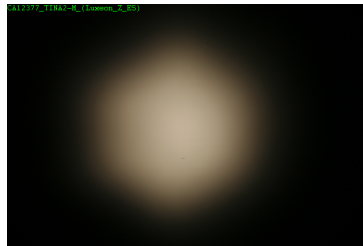

#### NICHIA

LED NVSxx19B/NVSxx19C  
 FWHM / FWTM 29.0° / 55.0°  
 Efficiency 85 %  
 Peak intensity 2.7 cd/lm  
 LEDs/each optic 1  
 Light colour White  
 Required components:



#### NICHIA

LED NWSx229A  
 FWHM / FWTM 26.0° / 52.0°  
 Efficiency 86 %  
 Peak intensity 2.2 cd/lm  
 LEDs/each optic 1  
 Light colour White  
 Required components:

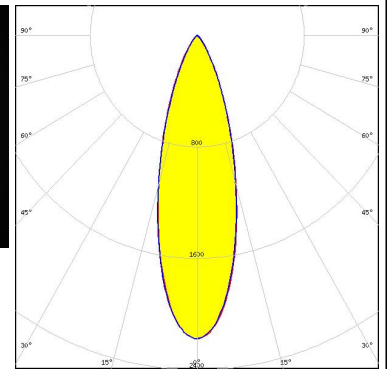
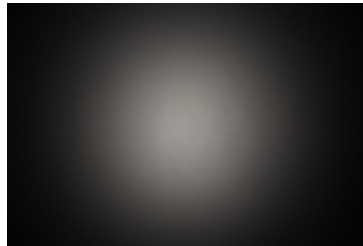



#### PHOTOMETRIC DATA (MEASURED):

##### OSRAM

Opto Semiconductors

LED OSLON Square EC  
 FWHM / FWTM 30.0° / 54.0°  
 Efficiency 85 %  
 Peak intensity 2.2 cd/lm  
 LEDs/each optic 1  
 Light colour White  
 Required components:

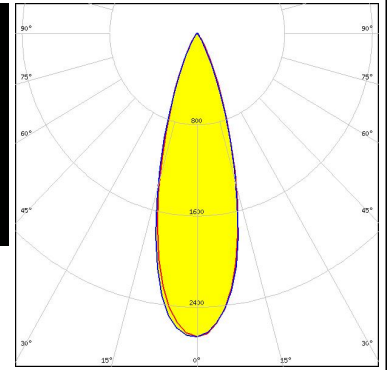

##### OSRAM

Opto Semiconductors

LED OSLON Square PC  
 FWHM / FWTM 29.0° / 53.0°  
 Efficiency 86 %  
 Peak intensity 2.4 cd/lm  
 LEDs/each optic 1  
 Light colour White  
 Required components:

##### OSRAM

Opto Semiconductors

LED OSLON SSL 150  
 FWHM / FWTM 30.0° / 51.0°  
 Efficiency 87 %  
 Peak intensity 2.5 cd/lm  
 LEDs/each optic 1  
 Light colour White  
 Required components:

##### OSRAM

Opto Semiconductors

LED SFH 4170S  
 FWHM / FWTM 28.0° / 50.0°  
 Efficiency %  
 LEDs/each optic 1  
 Light colour IR  
 Required components:

### PHOTOMETRIC DATA (MEASURED):

#### OSRAM Opto Semiconductors

LED SFH 4180S  
FWHM / FWTM 29.0° / 49.0°  
Efficiency %  
LEDs/each optic 1  
Light colour IR  
Required components:

#### OSRAM Opto Semiconductors

LED SFH 4715S  
FWHM / FWTM 28.0° / 56.0°  
Efficiency %  
LEDs/each optic 1  
Light colour IR  
Required components:

#### OSRAM Opto Semiconductors

LED SFH 4725S  
FWHM / FWTM 27.0° / 54.0°  
Efficiency %  
LEDs/each optic 1  
Light colour IR  
Required components:



SEOUL SEMICONDUCTOR

LED Z5M3  
FWHM / FWTM 30.0° / 57.0°  
Efficiency 83 %  
Peak intensity 2.5 cd/lm  
LEDs/each optic 1  
Light colour White  
Required components:

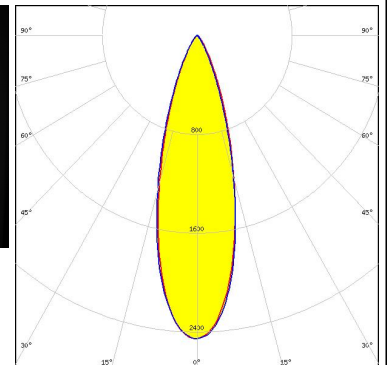
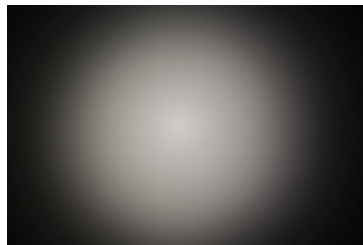

### PHOTOMETRIC DATA (SIMULATED):



LED XB-D White  
 FWHM / FWTM 30.0° / 55.0°  
 Efficiency 86 %  
 Peak intensity 2.7 cd/lm  
 LEDs/each optic 1  
 Light colour White  
 Required components:

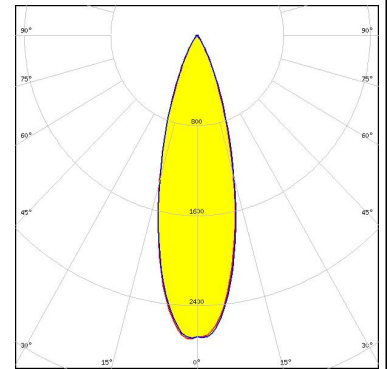

LED XQ-E HI  
 FWHM / FWTM 29.0° / 51.0°  
 Efficiency 90 %  
 Peak intensity 3.2 cd/lm  
 LEDs/each optic 1  
 Light colour White  
 Required components:

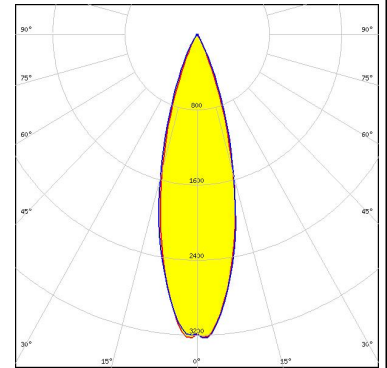

LED LUXEON 2835 Line  
 FWHM / FWTM 30.0° / 55.0°  
 Efficiency 96 %  
 Peak intensity 2.9 cd/lm  
 LEDs/each optic 1  
 Light colour White  
 Required components:

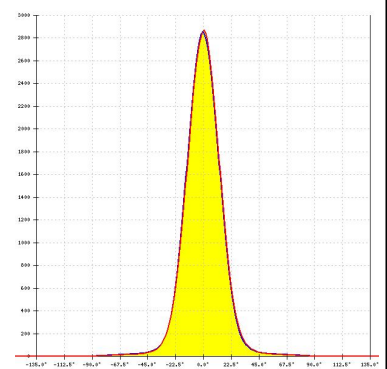

LED LUXEON C  
 FWHM / FWTM 30.0° / 52.0°  
 Efficiency 93 %  
 Peak intensity 2.9 cd/lm  
 LEDs/each optic 1  
 Light colour White  
 Required components:

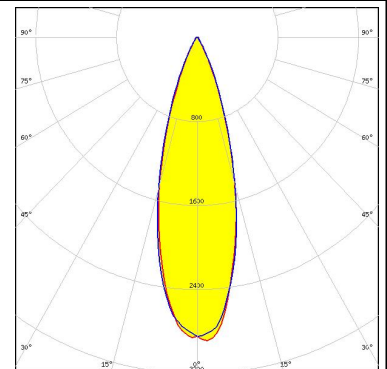

### PHOTOMETRIC DATA (SIMULATED):



LED LUXEON IR Compact  
 FWHM / FWTM 29.0° / 51.0°  
 Efficiency 83 %  
 LEDs/each optic 1  
 Light colour IR  
 Required components:



LED LUXEON SunPlus 20 Line (150 deg)  
 FWHM / FWTM 30.0° / 53.0°  
 Efficiency 89 %  
 Peak intensity 3 cd/lm  
 LEDs/each optic 1  
 Light colour White  
 Required components:

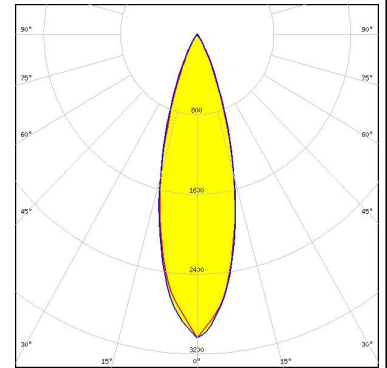

LED NFSx757G  
 FWHM / FWTM 29.0° / 53.0°  
 Efficiency 90 %  
 Peak intensity 3 cd/lm  
 LEDs/each optic 1  
 Light colour White  
 Required components:

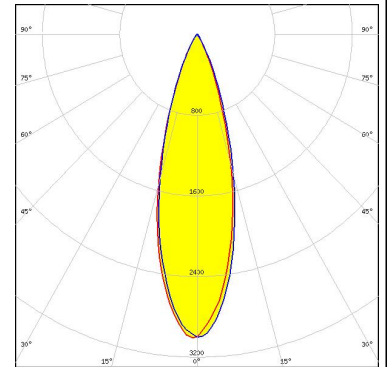

LED Duris S5 (2 chip)  
 FWHM / FWTM 29.0° / 54.0°  
 Efficiency 92 %  
 Peak intensity 3 cd/lm  
 LEDs/each optic 1  
 Light colour White  
 Required components:

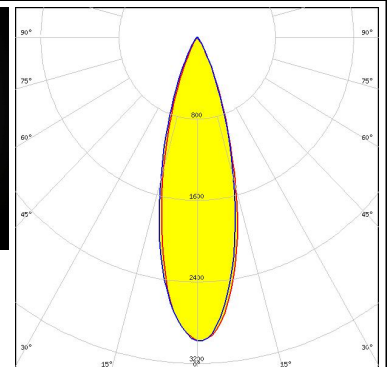
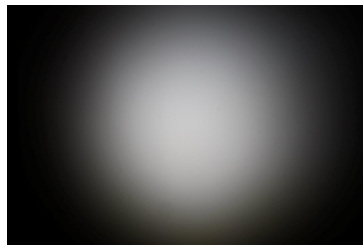

#### PHOTOMETRIC DATA (SIMULATED):

##### OSRAM

Opto Semiconductors

LED OSCONIQ P 3030  
 FWHM / FWTM 26.0° / 50.0 + 52.0°  
 Efficiency 90 %  
 Peak intensity 3.6 cd/lm  
 LEDs/each optic 1  
 Light colour Blue  
 Required components:

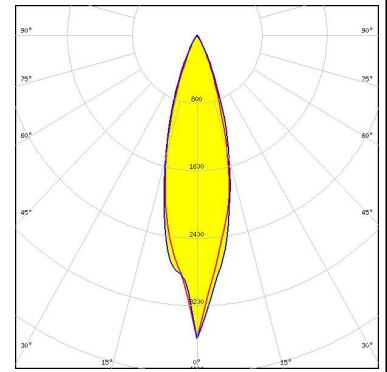

##### OSRAM

Opto Semiconductors

LED OSLON Black Flat  
 FWHM / FWTM 28.0° / 49.0°  
 Efficiency 91 %  
 Peak intensity 3.5 cd/lm  
 LEDs/each optic 1  
 Light colour White  
 Required components:

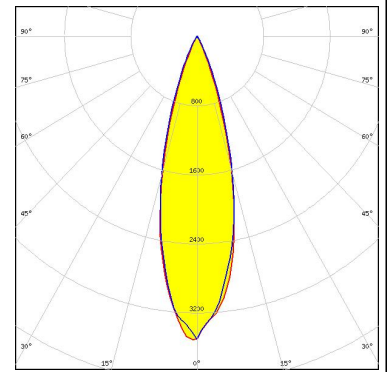

##### OSRAM

Opto Semiconductors

LED OSLON Square CSSRM2/CSSRM3  
 FWHM / FWTM 29.0° / 54.0°  
 Efficiency 90 %  
 Peak intensity 2.9 cd/lm  
 LEDs/each optic 1  
 Light colour White  
 Required components:

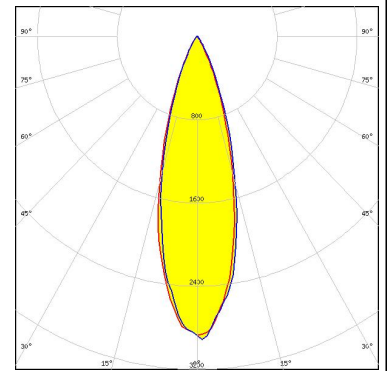

##### OSRAM

Opto Semiconductors

LED OSLON Square CSSRM2/CSSRM3  
 FWHM / FWTM 30.0° / 56.0°  
 Efficiency 90 %  
 Peak intensity 2.8 cd/lm  
 LEDs/each optic 1  
 Light colour White  
 Required components:

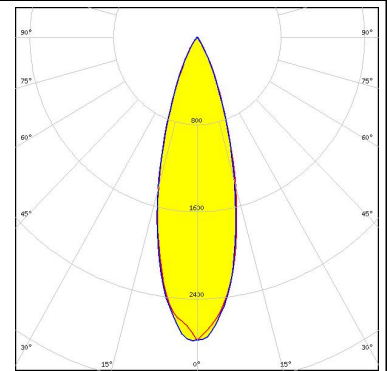

### PHOTOMETRIC DATA (SIMULATED):

#### OSRAM Opto Semiconductors

LED OSLON Square Flat  
 FWHM / FWTM 29.0° / 52.0°  
 Efficiency 89 %  
 Peak intensity 3.1 cd/lm  
 LEDs/each optic 1  
 Light colour White  
 Required components:

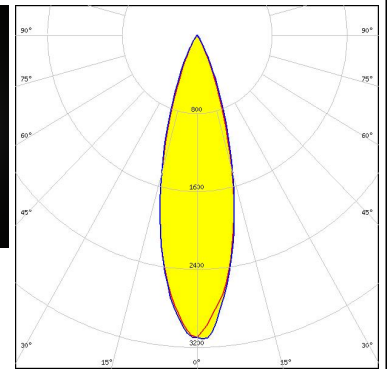
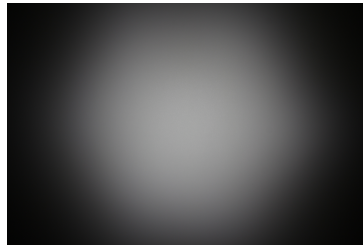

#### OSRAM Opto Semiconductors

LED OSLON SSL 80  
 FWHM / FWTM 29.0° / 53.0°  
 Efficiency 89 %  
 Peak intensity 3 cd/lm  
 LEDs/each optic 1  
 Light colour White  
 Required components:

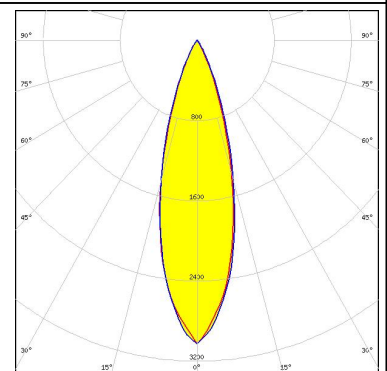

#### OSRAM Opto Semiconductors

LED SFH 4715S  
 FWHM / FWTM 28.0° / 51.0°  
 Efficiency 90 %  
 LEDs/each optic 1  
 Light colour IR  
 Required components:

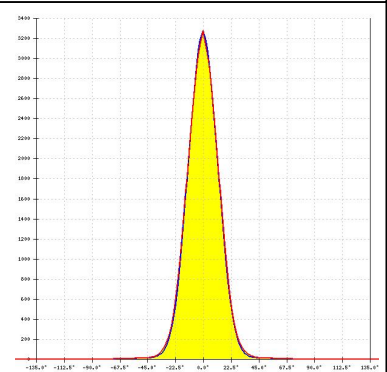

#### OSRAM Opto Semiconductors

LED SFH 4770S  
 FWHM / FWTM 27.0° / 51.0°  
 Efficiency 85 %  
 LEDs/each optic 1  
 Light colour IR  
 Required components:



### PHOTOMETRIC DATA (SIMULATED):

#### OSRAM

Opto Semiconductors

LED Synios P2720 1 mm  
 FWHM / FWTM 27.0° / 50.0°  
 Efficiency 91 %  
 Peak intensity 3.6 cd/lm  
 LEDs/each optic 1  
 Light colour White  
 Required components:

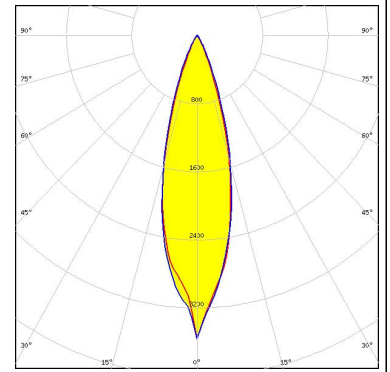

#### OSRAM

Opto Semiconductors

LED Synios P2720 1/2 mm  
 FWHM / FWTM 29.0° / 51.0°  
 Efficiency 93 %  
 Peak intensity 3.4 cd/lm  
 LEDs/each optic 1  
 Light colour White  
 Required components:

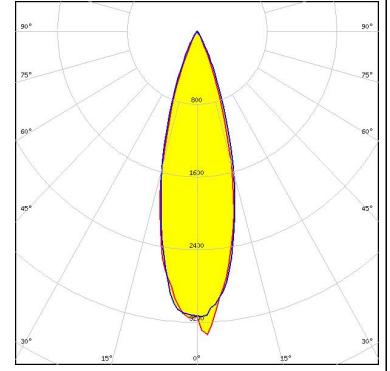

#### OSRAM

Opto Semiconductors

LED Synios P2720 1/4 mm  
 FWHM / FWTM 28.0° / 50.0°  
 Efficiency 91 %  
 Peak intensity 3.1 cd/lm  
 LEDs/each optic 1  
 Light colour White  
 Required components:

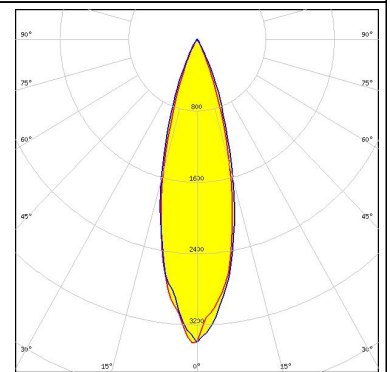

#### SAMSUNG

LED LH181B  
 FWHM / FWTM 29.0° / 53.5°  
 Efficiency 90 %  
 Peak intensity 3 cd/lm  
 LEDs/each optic 1  
 Light colour White  
 Required components:

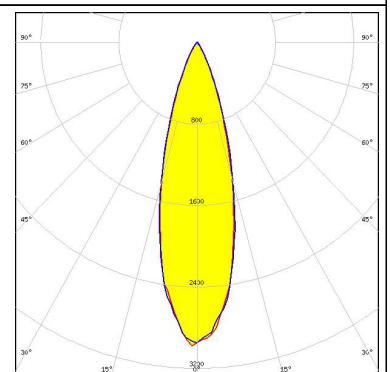

### GENERAL INFORMATION:

NOTE: The typical beam angle will be changed by different color, chip size and chip position tolerance. The typical total beam angle is the full angle measured where the luminous intensity is half of the peak value.

### MATERIALS:

As part of our continuous research and improvement processes, and to ensure the best possible quality and availability of our products, LEDiL reserves the right to change material grades without notice.

### PRODUCT DATA USER AGREEMENT AND DISCLAIMER:

The measured data in the provided downloadable LEDiL Product Datasheets and Mechanical 2D-Drawings is rounded and provided as reference for planning. LEDiL Oy's optical specifications have been verified by conducting performance testing of the products in accordance with the company's quality system. The reported data are averaged results of multiple measurements with typical variation. LEDiL Oy reserves the right to without prior notification make changes and improvements to its products.

LEDiL Oy assumes neither warranty, nor guarantee nor any other liability of any kind for the contents and correctness of the provided data. The provided data has been generated with highest diligence but the provided data may in reality not represent the complete possible variation range of all intrinsic parameters. Therefore, in certain cases a deviation from the provided data could occur.

LEDiL Oy reserves the right to undertake technical changes of its products without further notification which could lead to changes in the provided data. LEDiL Oy assumes no liability of any kind for the possible deviation from any provided data or any other damage resulting from the usage of the provided data.

The user agrees to this disclaimer and user agreement with the download or usage of the provided files.

#### LEDiL Oy

Joensuunkatu 13  
FI-24240 SALO  
Finland

#### LEDiL Inc.

228 West Page Street  
Suite D  
Sycamore IL 60178  
USA

#### Ledil Optics Technology (Shenzhen) Co., Ltd.

# 405 , Block B  
Casic Motor Building  
Shenzhen 518057  
P.R.CHINA

#### Local sales and technical support

[www.ledil.com/  
where\\_to\\_buy](http://www.ledil.com/where_to_buy)

#### Shipping locations

Salo, Finland  
Hong Kong, China

#### Distribution Partners

[www.ledil.com/  
where\\_to\\_buy](http://www.ledil.com/where_to_buy)

## X-ON Electronics

Largest Supplier of Electrical and Electronic Components

*Click to view similar products for [LED Lighting Lenses Assemblies](#) category:*

*Click to view products by [Ledil](#) manufacturer:*

Other Similar products are found below :

[FCN12592\\_LE1-D-COP](#) [CA16129\\_OLGA-W](#) [CA16370\\_HB-SQ-W](#) [FN15972\\_RONDA-ZT45-C](#) [CS15759\\_HB-2X2MX-8-W](#)  
[CA16435\\_LXP2-SS-WAS](#) [CN16210\\_GABRIELLA-MIDI-W](#) [CP17137\\_CARMEN-M2-C](#) [CA16015\\_STRADA-SQ-SCL](#) [CP17594\\_TINA-SC-](#)  
[RS](#) [CS15767\\_HB-2X2MX-8-M](#) [CP10960\\_RGBX-SS](#) [CP12395\\_LXP3-W](#) [CP12939\\_LARISA-RS-CLIP16](#) [C14636\\_XTM-PF-ADAPTER](#)  
[CA11819\\_STRADA-SQ-T-DW](#) [CA14508\\_G2-LXP2-D](#) [CA14601\\_VERONICA-SQ-MINI-RS](#) [FCP13895\\_SEANNA-A](#) [CP12943\\_LARISA-](#)  
[O-CLIP16](#) [FP11124\\_LISA2-O-PIN](#) [CS14597\\_HB-IP-2X6-O](#) [CP14995\\_FLORENTINA-HLD-O](#) [CS15158\\_STRADA-IP-2X6-T4-B](#)  
[CS16323\\_STRADELLA-IP-28-HB-M](#) [FN14976\\_STELLA-DWC2](#) [FN15264\\_STELLA-HB-WWW](#) [CA15584\\_ZORYA-MINI-TAPE](#)  
[FA15229\\_ROSE-MRK-S](#) [FA15232\\_ROSE-MRK-M](#) [FA15233\\_ROSE-MRK-W](#) [FCN13552\\_CRYSTAL-RS](#) [FN15552\\_RONDA-W](#)  
[FS15626\\_FLORENCE-3R-IP-Z90](#) [FS15786\\_FLORENCE-3R-IP-Z60](#) [FS15847\\_FLORENCE-3R-IP-O](#) [CA14505\\_G2-LXP2-RS2-P](#)  
[FCN12775\\_IRIS-O](#) [CP15304\\_LARISA-RS-PIN](#) [FN15679\\_RONDA-S](#) [CA15519\\_VERONICA-SQ-MINI-D](#) [FP14414\\_LISA2-O-PIN](#)  
[LL01CR-DF60L06-M2](#) [FN15993\\_RONDA-O](#) [FN15977\\_RONDA-WAS2](#) [CA14366\\_FLARE-MAXI-TAPE](#) [CA14442\\_VERONICA-SQ-W](#)  
[CA14509\\_G2-LXP2-M-P](#) [CA15231\\_VERONICA-SQ-MINI-W](#) [FP11002\\_LISA2-W-PIN](#)